

DS-M5504HNI Series Mobile Video Recorder



Key Feature

- User-friendly GUI providing easy and flexible operations.
- Pluggable 4G (FDD-LTE), 3G (WCDMA), and Wi-Fi module providing flexible data transmission solutions.
- Pluggable GPS (Global Positioning System) module precisely positioning the vehicle via the satellite and recording the location information in the video stream.
- Hikvision private protocol (4000 protocol) and ONVIF supported.
- 4 independent network interfaces connectable to 4 IP cameras; each channel supports up to 1080P resolution with H.264 encoding technology.
- Pluggable dummy HDD for HDD with up to 2 TB capacity.
- Stores videos on SD card when the HDDs/SSDs are broken.
- Information collection interfaces collect driving information such as left/right turn, braking, reversing, etc.
- Specialized aviation connectors ensuring signal stability.
- Shutdown delay (0 h to 6 h) and 24-hour scheduled startup/shutdown.
- Battery protection avoids vehicle from running out of battery.
- Wide-range power input (+9 VDC to +32 VDC).
- Power-off protection prevents key data loss.
- Aluminum die-cast chassis with no fan design well adaptable to working environment.
- Software-based firewall supported.
- Connectable to PTZ camera and PTZ control is supported.
- Support accessing via WEB browser.

Available Model

DS-M5504HNI,

DS-M5504HNI/GW, (supports 3G dialing)

DS-M5504HNI/GW/WI, (supports 3G dialing and Wi-Fi)

DS-M5504HNI/GLF/WI, (supports 4G dialing and Wi-Fi)



Specification

Model		DS-M5504HNI
Video/Audio Input	IP Camera	4
	Two-way Audio	1, integrated in EXT.DEV interface
Video/Audio Output	Video Output	CVBS: 2, PAL: 704 × 576, NTSC: 704 × 480 VGA: 1, 1920 × 1080/60Hz, 1280 × 1024/60Hz, 1280 × 720/60Hz, 1024 × 768/60Hz
	Audio Output	2
Encoding/Decoding Parameters	Video Compression	H.264
	Encoding Resolution	Main stream: 1080p/720p/WD1/4CIF. Sub-stream: 4CIF/2CIF/CIF
	Frame Rate	PAL: 1 to 25 fps, NTSC: 1 to 30 fps;
	Audio Compression	G.711
	Stream Type	Video, Video & Audio
	Audio Bitrate	16 Kbps
	Dual Stream	Supported
Storage	HDD/SSD	2 × 2.5 inch HDD/SSD, up to 2 TB for each HDD/SSD A dummy HDD with USB 3.0 interface
	SD Card	1 × SD card, up to 256 GB
Wireless Network	3G/4G Dialing	1 × 3G/4G card slot, 1 × SMA antenna
	Wi-Fi	1 × 2.4 G Wi-Fi SMA antenna
Positioning	GNSS (Global Navigation Satellite System)	GPS (Global Positioning System), 1 × SMA antenna
PoE	PoE Interface	4 × RJ45 10M/100M self-adaptive PoE interface
	Max. Consumption	≤ 30W (in total)
External Interface	Network Interface	1 × 10M/100M RJ45 Ethernet interface
	Serial Port	1 × RS-232, 1 × RS-422
	USB Interface	<ul style="list-style-type: none"> ● Front panel: 1 × USB 2.0 ● Rear panel: 1 × USB of 5-pin aviation plug
	Sensor-in	4 high/low level signal inputs
	Alarm Input	3 high/low level signal inputs, 1 pulse signal input (reserved)
	Alarm Output	2 relay signal outputs
General	Operating Method	Mouse, IR remote control, Web control
	Power Supply	9 to 32 VDC
	Consumption	<ul style="list-style-type: none"> ● Standby: ≤ 0.5 W ● Full load: ≤ 70 W Note: Without peripheral and storage media: ≤ 20 W
	Working Temperature	<ul style="list-style-type: none"> ● Device that provides dummy HDD with heating function: -30 °C to +60 °C (-22 °F to +140°F) ● Other devices: -10 °C to +60 °C (14 °F to 140°F)
	Working Humidity	10% to 90%
	Dimensions (W × D × H)	206 × 248.4 × 60 mm (8.1 × 9.8 × 2.4 inch)
	Weight (Without Storage Media)	1.6 kg (3.53 lb)

Physical Interface

Front Panel

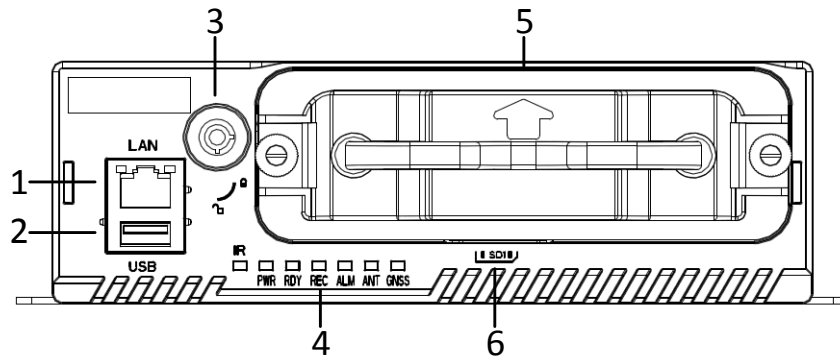

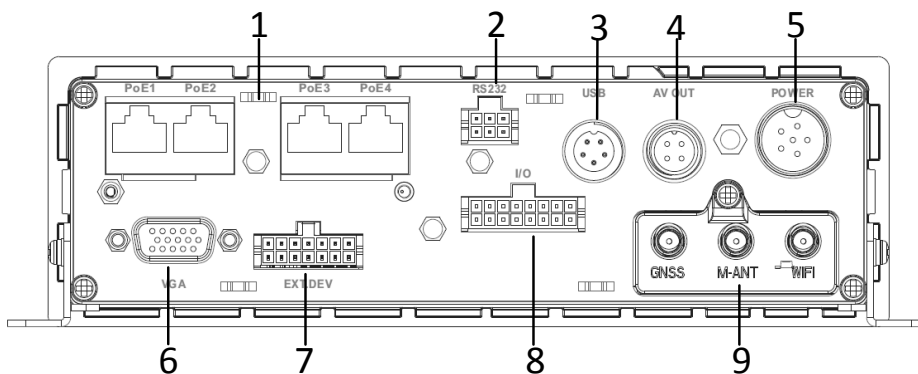

No.	Name	No.	Name
1	LAN Network Interface	4	Indicators
2	USB Interface	5	Dummy HDD
3	Hard Disk Lock	6	SD Card Slot

Rear Panel

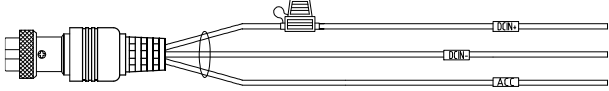
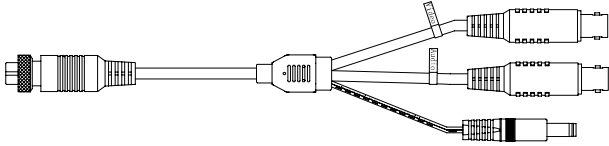
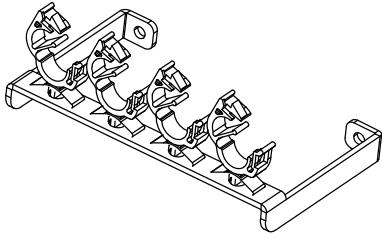
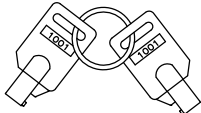
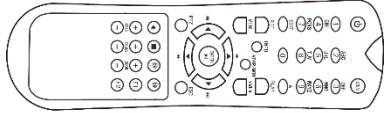
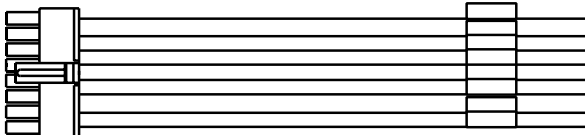
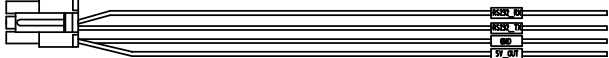
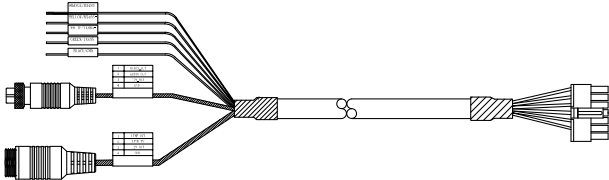

No.	Name	No.	Name
1	PoE1 to PoE4 Interfaces	6	VGA Interface
2	RS-232 Interface	7	EXT. DEV (including audio output, two-way audio and RS-422)
3	USB Interface	8	I/O (including alarm in, alarm out and sensor in)
4	AV OUT	9	Pluggable Module (including 3G/4G, Wi-Fi and GPS)
5	Power Supply		

Packing List

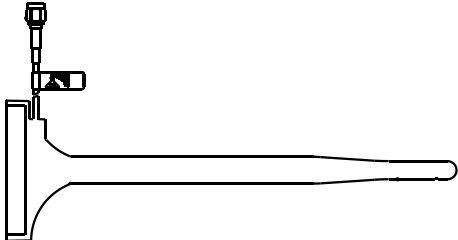
Description	Quantity	Picture	Note
Fuse	2		
Power cord	1		
Aviation plug-to-BNC cable	1		
Network cable clip	4		
Network cable bracket	1		
Network cable bracket screw	2		
Key	1		
Remote control	1		
Alarm line	1		
Serial port line	1		
Extension cable	1		
Screwdriver	1		
3G antenna	1		For GW model.

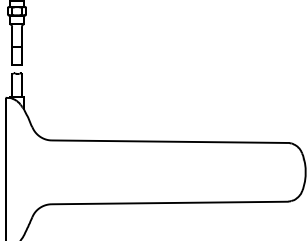
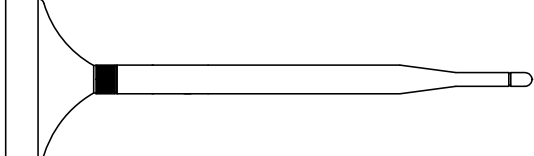
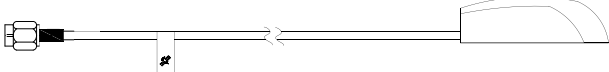
Description	Quantity	Picture	Note
4G antenna	1		For GLF model.
Wi-Fi antenna	1		For WI model.
GPS antenna	1		For model with GPS module.

Peripheral Connection

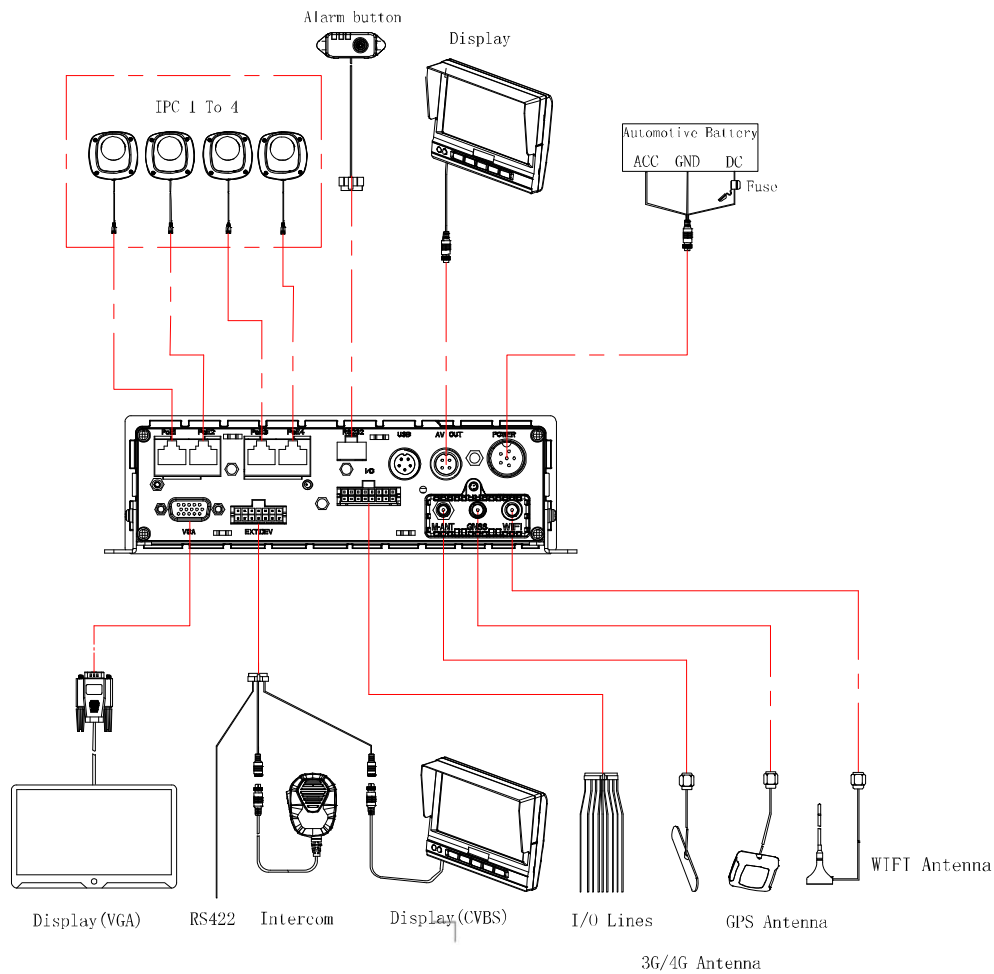

Distributed by



Headquarters

No.555 Qianmo Road, Binjiang District,
Hangzhou 310051, China
T +86-571-8807-5998
overseasbusiness@hikvision.com

Hikvision USA
T +1-909-895-0400
sales.usa@hikvision.com

Hikvision Europe
T +31-23-5542770
sales.eu@hikvision.com

Hikvision UK & Ireland
T +01628-902140
sales.uk@hikvision.com

Hikvision UAE
T +971-4-4432090
salesme@hikvision.com

Hikvision Russia
T +7-495-669-67-99
saleru@hikvision.com

Hikvision Australia
T +61-2-8599-4233
salesau@hikvision.com

Hikvision Italy
T +39-0438-6902
info.it@hikvision.com

Hikvision South Africa
Tel: +27 (10) 0351172
sale.africa@hikvision.com

Hikvision Singapore
T +65-6684-4718
sg@hikvision.com

Hikvision Korea
T +82-(0)31-731-8817
sales.korea@hikvision.com

Hikvision India
T +91-22-28469900
sales@pramahikvision.com

Hikvision Brazil
T +55 11 3318-0050
Latam.support@hikvision.com

Hikvision France
T +33(0)1-85-330-450
info.fr@hikvision.com

Hikvision Spain
T +34-91-737-16-55
info.es@hikvision.com

Hikvision Poland
T +48-22-460-01-50
info.pl@hikvision.com

Hikvision Canada
T +1-866-200-6690
sales.canada@hikvision.com

Hikvision Turkey
T +90 (216)521 7070- 7074
sales.tr@hikvision.com

Hikvision Kazakhstan
T +7-727-9730667
nikia.panfilov@hikvision.ru

Hikvision Tashkent
T +99-87-1238-9438
uzb@hikvision.ru

Hikvision Indonesia
T +62-21-2933759
Sales.Indonesia@hikvision.com

Hikvision Thailand
T +662-275-9949
sales.thailand@hikvision.com

Hikvision Malaysia
T +601-7652-2413
sales.my@hikvision.com

Hikvision Vietnam
T +84-974270888
sales.vt@hikvision.com

Hikvision Hong Kong
T +852-2151-1761
info.hk@hikvision.com

Hikvision Colombia
sales.colombia@hikvision.com