

## Key Features

- 5 MP high performance CMOS
- Auto focus
- 2560 × 1944 resolution
- 2.7 mm to 13.5 mm motorized vari-focal lens
- EXIR 2.0, smart IR, up to 60 m IR distance
- OSD menu, 3D DNR, 130 dB true WDR
- 4 in 1 video output (switchable TVI/AHD/CVI/CVBS)
- Up the coax (HIKVISION-C)



## Specification

| <b>Camera</b>                |  |
|------------------------------|--|
| Image Sensor                 | 5 megapixel progressive scan CMOS  |
| Signal System                | PAL/NTSC   |
| Resolution                   | 2560 (H) × 1944 (V)  |
| Min. Illumination            | Color: 0.003 Lux @ (F1.2, AGC ON), 0 Lux with IR   |
| Frame Rate                   | TVI: 2 MP@25fps, 2 MP@30fps, 4 MP@25fps, 4 MP@30fps, 5 MP@20fps<br>AHD: 4 MP@25fps, 4 MP@30fps, 5 MP@20fps<br>CVI: 4 MP@25fps, 4 MP@30fps<br>CVBS: PAL, NTSC |
| Shutter Time                 | PAL: 1/25 s to 1/50, 000 s<br>NTSC: 1/30 s to 1/50, 000 s  |
| Lens                         | 2.7 mm to 13.5 mm motorized vari-focal lens  |
| Horizontal Field of View     | 92.3° to 29.3°   |
| Lens Mount                   | Φ 14   |
| Day & Night                  | IR cut filter  |
| Angle Adjustment             | Pan: 0° to 340°; Tilt: 0° to 75°; Rotate: 0° to 355°   |
| Synchronization              | Internal synchronization   |
| WDR (Wide Dynamic Range)     | ≥ 130 dB   |
| <b>Menu</b>                  |  |
| AGC                          | Yes  |
| D/N Mode                     | Auto/Color/BW (Black and White)  |
| White Balance                | Auto/Manual  |
| BLC (Backlight Compensation) | Yes  |
| WDR                          | Yes  |
| 3D DNR                       | Level 1 to 9   |
| Privacy Mask                 | 4 programmable privacy masks   |
| Motion Detection             | 4 programmable areas   |
| Language                     | English  |
| Functions                    | Brightness, Sharpness, 3D DNR, Mirror, Smart IR  |
| <b>Interface</b>             |  |
| Video Output                 | 1 HD analog output   |
| Switch Button                | TVI/AHD/CVI/CVBS   |
| <b>General</b>               |  |
| Operating Conditions         | -40 °C to 50 °C (-40 °F to 122 °F), humidity: 90% or less (non-condensation)   |
| Power Supply                 | -A: 9.6 VDC to 14.4 VDC; 19.2 VAC to 28.8 VAC  |
| Power Consumption            | -A: Max. 8 W   |
| Material                     | Plastic  |
| IR Range                     | Up to 60 m   |
| Communication                | Up the coax, Protocol: HIKVISION-C (TVI output)  |
| Dimensions                   | Ø 136 mm × 101.9 mm ( Ø 5.35" × 4.01")   |
| Weight                       | Approx. 430 g (0.95 lb.)   |

**Order Model**

DS-2CE56H8T-AITZF

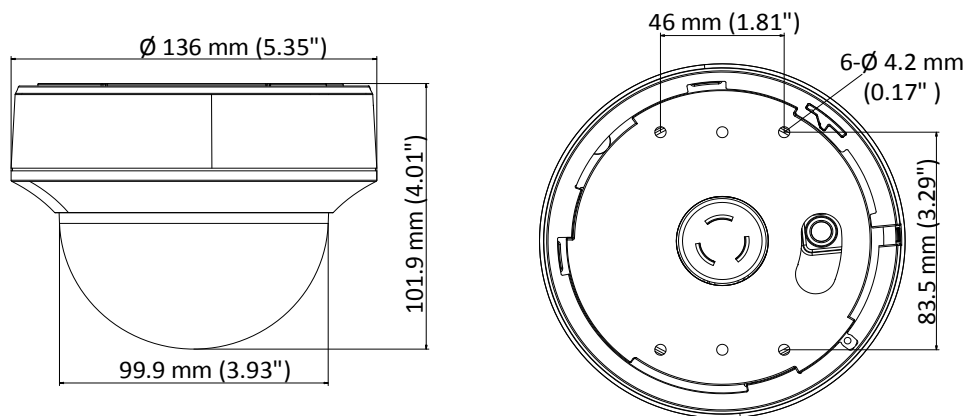
**Dimension**

**Accessory**

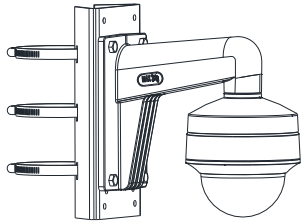

**DS-1275ZJ-SUS**  
Vertical Pole Mount

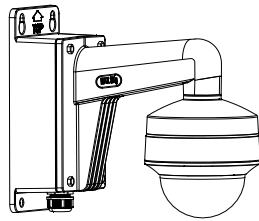

**DS-1273ZJ-130B**  
Wall Mount

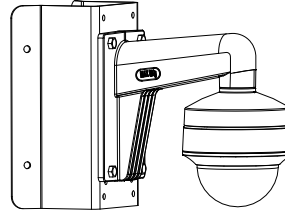

**DS-1276ZJ-SUS**  
Corner Mount

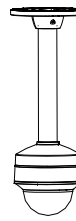

**DS-1271ZJ-130**  
Pendant Mount

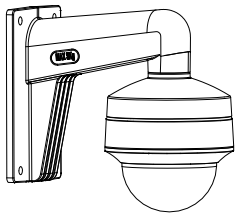

**DS-1273ZJ-130**  
Pendant Mount

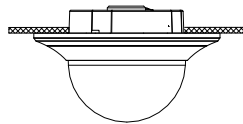

**DS-1249ZJ**  
In-ceiling Mount

Distributed by



**HIKVISION**

**Headquarters**

No.555 Qianmo Road, Binjiang District,  
Hangzhou 310051, China  
T +86-571-8807-5998  
overseasbusiness@hikvision.com

**Hikvision USA**  
T +1-909-895-0400  
sales.usa@hikvision.com

**Hikvision Europe**  
T +31-23-55-42-770  
info.eu@hikvision.com

**Hikvision Middle East**  
T +971-4-8816086  
salesme@hikvision.com

**Hikvision Russia**  
T +7-495-669-67-99  
saleru@hikvision.com

**Hikvision India**  
T +91-22-28469900  
sales@pramahikvision.com

**Hikvision Italy**  
T +39-0438-6902  
info.it@hikvision.com

**Hikvision France**  
T +33(0)1-85-330-450  
info.fr@hikvision.com

**Hikvision Spain**  
T +34-91-737-16-55  
info.es@hikvision.com

**Hikvision Poland**  
T +48-22-460-01-50  
poland@hikvision.com

**Hikvision UK**  
T +01628-902140  
support.uk@hikvision.com

**Hikvision Singapore**  
T +65-6684-4718  
sg@hikvision.com

**Hikvision Oceania**  
T +61-2-8599-4233  
salesau@hikvision.com

**Hikvision Canada**  
T +1-909-895-0400  
sales.usa@hikvision.com

**Hikvision Korea**  
T +82-31-731-8841  
sales.korea@hikvision.com

**Hikvision Brazil**  
T +55 11 3318-0050  
Latam.support@hikvision.com

**Hikvision Africa**  
T +27 (0) 0351172  
sale.africa@hikvision.com

**Hikvision Hong Kong**  
T +852-2151-1761