

DarkFighter

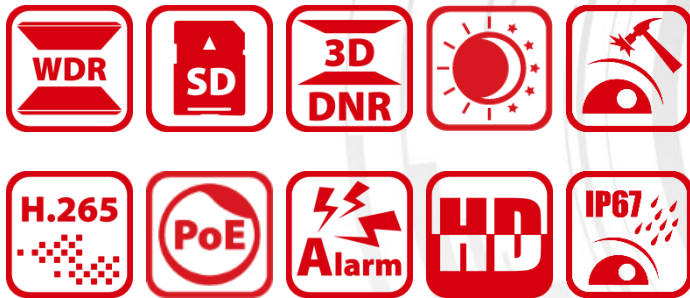

Hikvision DS-2DF8436IX-AEL(W) 4MP 36× Network IR Speed Dome adopts 1/1.8" progressive scan CMOS chip. With the 36× optical zoom lens, the camera offers more details over expansive areas.

This series of cameras can be widely used for wide ranges of high-definition, such as the rivers, forests, roads, railways, airports, ports, squares, parks, scenic spots, stations and large venues, etc.

Key Features

- 1/1.8" progressive scan CMOS
- Up to 2560 × 1440 resolution
- Min. Illumination:
Color: 0.002 Lux @(F1.5, AGC ON)
B/W: 0.0002 Lux @(F1.5, AGC ON)
0 Lux with IR
- 36× optical zoom, 16× digital zoom
- WDR, 3D DNR, HLC, Smart IR
- 24 VAC & Hi-PoE
- Up to 200 m IR distance
- Support H.265+/H.265 video compression
- Support rapid focus
- Deep-learning-based target classification algorithm for auto-tracking 2.0 and perimeter protection



Specification

Camera Module	
Image Sensor	1/1.8" progressive scan CMOS
Min. Illumination	Color: 0.002 Lux @(F1.5, AGC ON) B/W: 0.0002 Lux @(F1.5, AGC ON) 0 Lux with IR
Shutter Time	1/1 s to 1/30,000 s
White Balance	Auto/Manual/ATW (Auto-tracking White Balance)/Indoor/Outdoor/Fluorescent Lamp/Sodium Lamp
AGC	Auto/Manual
Day & Night	IR cut filter
Digital Zoom	16×
Privacy Mask	24 programmable polygon privacy masks, mask color or mosaic configurable
Focus Mode	Auto/Semi-automatic/Manual
3D DNR	Yes
BLC	Yes
HLC	Yes
WDR	120 dB
Optical Defog	Yes
EIS	Yes
Regional Exposure	Yes
Regional Focus	Yes
Rapid Focus	Yes
Lens	
Focal Length	5.7 mm to 205.2 mm, 36× Optical
Zoom Speed	Approx. 4.4 s (optical lens, wide-tele)
Field of View	Horizontal field of view: 51.1° to 1.7° (wide-tele) Vertical field of view: 31.3° to 1.0° (wide-tele) Diagonal field of view: 58.0° to 2.0° (wide-tele)
Working Distance	10 mm to 1500 mm (wide-tele)
Aperture Range	F1.5 to F4.5
PTZ	
Movement Range (Pan)	360° endless
Pan Speed	Configurable, from 0.1°/s to 210°/s, Preset Speed: 280°/s
Movement Range (Tilt)	From -20° to 90°
Tilt Speed	Configurable, from 0.1°/s to 150°/s, Preset Speed: 250°/s
Proportional Zoom	Yes
Presets	300
Patrol Scan	8 patrols, up to 32 presets for each patrol
Pattern Scan	4 pattern scans, record time over 10 minutes for each scan
Power-off Memory:	Yes
Park Action	Preset/Pattern Scan/Patrol Scan/Auto Scan/Tilt Scan/Random Scan/Frame Scan/Panorama Scan
PTZ Status Display	Yes
Preset Freezing	Yes
Scheduled Task	Preset/Pattern Scan/Patrol Scan/Auto Scan/Tilt Scan/Random Scan/Frame Scan/Panorama Scan/Dome Reboot/Dome Adjust/Aux Output
Smart Features	
Perimeter Protection	Intrusion, Line Crossing, Region Entrance, Region Exiting Support alarm triggering by specified target types (human and vehicle) Filtering out mistaken alarm caused by target types such as leaf, light, animal, and flag, etc.
Event Detection	Unattended Baggage Detection, Object Removal Detection, Face Detection, Audio Exception Detection
Smart Tracking	Manual Tracking, Auto Tracking (support tracking specified target types such as human and vehicle), Event Tracking

Smart Record	ANR (Automatic Network Replenishment), Dual-VCA
ROI	Eight fixed region for each stream
IR	
IR Distance	200 m
Smart IR	Yes
Network	
Max. Resolution	2560 × 1440
Main Stream	50Hz: 25fps (2560 × 1440, 2048 × 1536, 1920 × 1080, 1280 × 960, 1280 × 720) 60Hz: 30fps (2560 × 1440, 2048 × 1536, 1920 × 1080, 1280 × 960, 1280 × 720)
Sub-Stream	50Hz: 25fps (704 × 576, 640 × 480, 352 × 288) 60Hz: 30fps (704 × 480, 640 × 480, 352 × 240)
Third Stream	50Hz: 25fps (1920 × 1080, 1280 × 960, 1280 × 720, 704 × 576, 640 × 480, 352 × 288) 60Hz: 30fps (1920 × 1080, 1280 × 960, 1280 × 720, 704 × 480, 640 × 480, 352 × 240)
SVC	Yes
Video Compression	Main Stream: H.265+/H.265/H.264+/H.264 Sub-Stream: H.265/H.264/MJPEG Third Stream: H.265/H.264/MJPE H.264 with Baseline/Main/High Profile
Audio compression	G.711alaw/G.711ulaw/G.722.1/G.726/MP2L2/PCM
Protocols	IPv4/IPv6, HTTP, HTTPS, 802.1x, Qos, FTP, SMTP, UPnP, SNMP, DNS, DDNS, NTP, RTSP, RTCP, RTP, TCP/IP, DHCP, PPPoE, UDP, IGMP, ICMP, Bonjour
Simultaneous Live View	Up to 20 channels
User/Host	Up to 32 users 3 levels: Administrator, Operator and User
Security Measures	User authentication (ID and PW), Host authentication (MAC address); HTTPS encryption; IEEE 802.1x port-based network access control; IP address filtering
System Integration	
Alarm Interface	7-ch alarm input/2-ch alarm output
Audio Interface	1-ch audio input, 2 to 2.4 V[p-p], 1 K Ω \pm 10% 1-ch audio output, line level, impedance: 600 Ω
Alarm Linkage	Alarm actions, such as Preset, Patrol Scan, Pattern Scan, Memory Card Video Record, Trigger Recording, Notify Surveillance Center, Upload to FTP/Memory Card/NAS, Send Email, etc.
Network Interface	1 RJ45 10 M/100 M Ethernet Interface; Hi-PoE
CVBS	Support
RS-485	HIKVISION, Pelco-P, Pelco-D, self-adaptive
Storage	Built-in memory card slot, support Micro SD/SDHC/SDXC, up to 256 GB; NAS (NFS, SMB/CIFS), ANR
API	ONVIF (Profile S, Profile G, Profile T), ISAPI, SDK
Client	iVMS-4200, iVMS-4500, iVMS-5200, Hik-Connect
Web Browser	IE 8 to 11, Chrome 31.0+, Firefox 30.0+, Edge 16.16299+, Safari 11+
General	
Language (Web Browser Access)	32 languages. English, Russian, Estonian, Bulgarian, Hungarian, Greek, German, Italian, Czech, Slovak, French, Polish, Dutch, Portuguese, Spanish, Romanian, Danish, Swedish, Norwegian, Finnish, Croatian, Slovenian, Serbian, Turkish, Korean, Traditional Chinese, Thai, Vietnamese, Japanese, Latvian, Lithuanian, Portuguese (Brazil)
Power	24 VAC (Max. 60 W, including max. 18 W for IR and max. 6 W for heater) Hi-PoE (Max. 50 W, including max. 18 W for IR and max. 6 W for heater)
Working Temperature	Outdoor: -40°C to 70°C (-40°F to 158°F)
Working Humidity	\leq 90%
Protection Level	IP67 Standard, IK10 (only supported by camera without wiper), 6,000V Lightning Protection, Surge Protection and Voltage Transient Protection
Dimensions	Φ 266.6 mm × 410 mm (Φ 10.50" × 16.14")
Weight	Approx. 8 kg (17.64 lb)

DORI

The DORI (detect, observe, recognize, identify) distance gives the general idea of the camera ability to distinguish persons or objects within its field of view.

It is calculated based on the camera sensor specification and the criteria given by EN 62676-4: 2015.

DORI	Detect	Observe	Recognize	Identify
Definition	25 px/m	63 px/m	125 px/m	250 px/m
Distance (Tele)	2786.2 m (9141.1 ft)	1105.6 m (3627.4 ft)	557.2 m (1828.2 ft)	278.6 m (914.1 ft)

Order Model

DS-2DF8436IX-AEL (C), without wiper, 24 VAC & Hi-PoE

DS-2DF8436IX-AELW (C), with wiper, 24 VAC & Hi-PoE

Dimensions

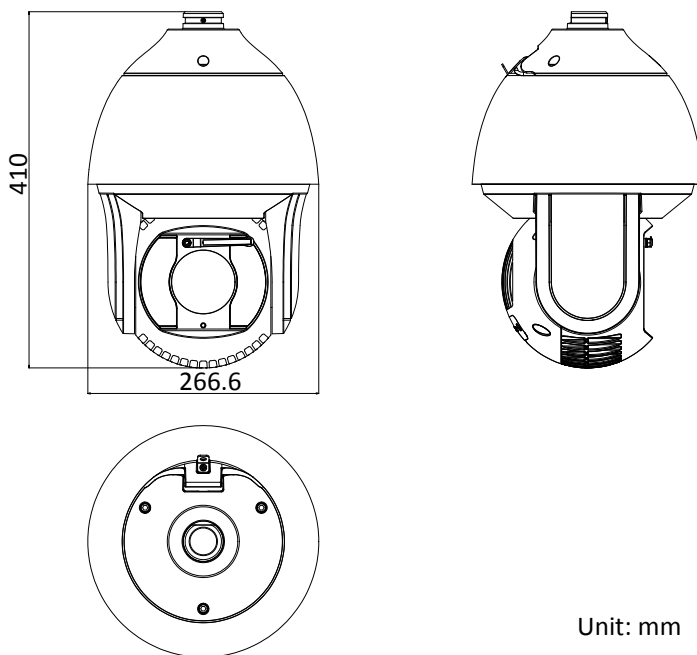

Unit: mm

Accessory

Included:



Installation Adapter

Optional:



DS-1604ZJ
Wall Mount

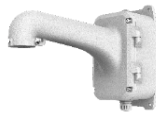

DS-1604ZJ-box
Wall Mount with Junction
Box



DS-1604ZJ-box-pole
Vertical Pole Mount with
Junction Box



DS-1604ZJ-box-corner
Corner Mount with
Junction Box



DS-1660ZJ
Parapet Mount



DS-1619ZJ
Gooseneck Mount



DS-1661ZJ
Pendant Mount



DS-1662ZJ
Pendant Mount



DS-1663ZJ
Ceiling Mount



DS-1667ZJ
Extendable Pole for
Pendant Mount



DS-1673ZJ
Horizontal Pole Mount



DS-1682ZJ
Extendable Pole for
Pendant Mount

Distributed by



LAS60-57CN-RJ45
Hi-PoE Midspan



TEAC-66-243000V (EU)
MKAC-66-243000U (USA)
TEAC-66-243000VB (UK)
Power Adapter

HIKVISION®

Headquarters

No.555 Qianmo Road, Binjiang District,
Hangzhou 310051, China
T +86-571-8807-5998
overseasbusiness@hikvision.com

Hikvision USA
T +1-909-895-0400
sales.usa@hikvision.com

Hikvision Australia
T +61-2-8599-4233
salesau@hikvision.com

Hikvision India
T +91-22-28469900
sales@pramahikvision.com

Hikvision Canada
T +1-866-200-6690
sales.canada@hikvision.com

Hikvision Thailand
T +662-275-9949
sales.thailand@hikvision.com

Hikvision Europe
T +31-23-5542770
sales.eu@hikvision.com

Hikvision Italy
T +39-0438-6902
info.it@hikvision.com

Hikvision Brazil
T +55 11 3318-0050
Latam.support@hikvision.com

Hikvision Turkey
T +90 (216)521 7070- 7074
sales.tr@hikvision.com

Hikvision Malaysia
T +601-7652-2413
sales.my@hikvision.com

Hikvision UK & Ireland
T +01628-902140
sales.uk@hikvision.com

Hikvision South Africa
Tel: +27 (10) 0351172
sale.africa@hikvision.com

Hikvision France
T +33(0)1-85-330-450
info.fr@hikvision.com

Hikvision Kazakhstan
T +7-727-9730667
nikia.panfilov@hikvision.ru

Hikvision Vietnam
T +84-974270888
sales.vt@hikvision.com

Hikvision UAE
T +971-4-4432090
salesme@hikvision.com

Hikvision Singapore
T +65-6684-4718
sg@hikvision.com

Hikvision Spain
T +34-91-737-16-55
info.es@hikvision.com

Hikvision Tashkent
T +99-87-1238-9438
uzb@hikvision.ru

Hikvision Hong Kong
T +852-2151-1761
info.hk@hikvision.com

Hikvision Russia
T +7-495-669-67-99
saleru@hikvision.com

Hikvision Korea
T +82-(0)31-731-8817
sales.korea@hikvision.com

Hikvision Poland
T +48-22-460-01-50
info.pl@hikvision.com

Hikvision Indonesia
T +62-21-2933759
Sales.Indonesia@hikvision.com

Hikvision Colombia
sales.colombia@hikvision.com