



Hikvision's 2nd Generation IP and Two-Wire Video Intercom Solution

# Modern Convenience, Robust Security

**HIKVISION**

# Hikvision Intercom: A Communication Tool that Integrates with Access Control



Hikvision is an innovative, industry leader, and its intercom solution reflects this. Our next generation of intercom products are modular, providing greater flexibility and customization for a wide array of applications. Both IP and Two-Wire intercom systems come equipped with a 2 MP 180-degree camera with built-in IR that can be integrated with Hikvision's video recorder as a surveillance camera, allowing users to view live video, record and playback seamlessly at the door.

Hikvision's modular IP door station is stylish, affordable and scalable for applications of all sizes. Hikvision's complete intercom package hosts an abundance of functionality, from traditional nametag and keypad modules, as well as innovative new features. The intercom can also be added to Hikvision NVRs or DVRs as an IP camera for front door monitoring, and is suitable for a variety of applications.

Easily capturing your entrance, doorstep, and more, our video intercoms also provide these valuable features:

- Full HD video quality at your door, capable of integrating with Hikvision recorders.
- Clear audio communication with echo and noise cancellation.
- 180-degree 2 MP Fisheye HD camera with IR for clear video in the dark.
- Mobile app enables user to speak to visitors and unlock doors remotely.
- User-friendly 7-inch touch screen LCD, also functions as a monitor for Hikvision cameras.
- Choose the best fit for your application with flexible and customizable modular design.
- Access control module and keypad module allow tenant entrance using key card or passcode.

# Applications



## Single Family Homes

Intercoms offers many convenient features, so users can communicate with visitors outside their door, both remotely and when at home. Users can communicate with one another with the touch of a button using room-to-room communication.



## Commercial Buildings

Business intercom provides an additional layer of security to monitor access control. The built-in access control function adds an additional layer of protection, giving business owners and facility managers greater control over who is allowed to enter the building.



## Multi-Family Homes and Condominiums

In multi-family homes and condominiums, intercoms allow numerous tenants and daily visitors to communicate safely and remotely. They also provide added security for landlords and building owners. Performing 24/7, the technology acts as a virtual security guard without any additional monthly cost to the building owner.



## Hotels & Hospitality

Intercoms for hotels enable front desk staff to speak to visitors or guests remotely 24/7, adding additional security and ensuring only authorized personnel and guests are allowed to enter after hours.



## Gate Operation (Residential & Commercial)

Intercoms support secure gate operations for residential communities, golf and fitness clubs, and other commercial entrances. It integrates with access control to help manage facilities and maintain safety for visitors and residents.



## K-12 Schools

School districts can use intercoms with access control to prevent unauthorized entry into the school. It enables on-site security and staff to communicate with and identify visitors before they gain entrance to school grounds.

## IP Intercom Solution



### IP Intercom Main Module

DS-KD8003-IME1

- 2 MP Fisheye Camera with 180° Horizontal Field of View
- IR Supplement Light for Dark Environments
- Supports Standard PoE

*\*DS-KD8003-IME1/Surface – Surface Mounting Frame Included*

*\*DS-KD8003IME1/Flush – Flush Mount Frame Included*



### 7" IP Intercom Indoor Station

DS-KH8350-WTE1

- User Friendly Touch Screen Interface
- Remote Unlocking via Mobile Client
- Supports Standard PoE



### 7" IP Intercom Indoor Station

DS-KH6320-WTE1

- User Friendly Touch Screen Interface
- Remote Unlocking via Mobile Client
- Supports Standard PoE

## Two-Wire Intercom Solution



### Two-Wire Intercom Main Module

DS-KD8003-IME2

- 2 MP Fisheye Camera with 180° Horizontal Field of View
- IR Supplement Light for Dark Environments



### 7" Two-Wire Intercom Indoor Station

DS-KH6320-WTE2

- User Friendly Touch Screen Interface
- Remote Unlocking via Mobile Client



### Two-Wire Power & Data Distributor

DS-KAD706-P

- Two-Wire Intercom Video, Audio Distribution, and Power Supply
- Provides Power to Outdoor and Indoor Stations

DS-KAD706-SP

- Two-Wire Intercom Video and Audio Distribution Extender
- Expand Total of Apartment Units up to 500\*

*\*Required when exceed 90 apartment units*

## IP and Two-Wire Intercom Modules

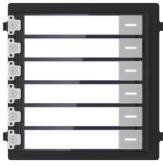

**Intercom Nametag Module**  
DS-KD-KK

- 6 Physical Buttons
- Backlit Buttons



**Intercom Keypad Module**  
DS-KD-KP

- Backlit Numeric Buttons
- Resident Calling by Apartment Number
- Supports Passcode Entry



**Intercom LCD Module**  
DS-KD-DIS

- 3.5" LCD Screen with 320 x 480 Resolution
- Up to 500 Contacts Supported
- Apartment Index
- Supports Multiple Languages



**Intercom Card Reader Module**  
DS-KD-M

- Backlit Mifare Card Reader Module

## IP and Two-Wire Intercom Mounting Frames



**2 Modules Flush Mount Frame**  
DS-KD-ACF2  
DS-KD-ACF2/Plastic

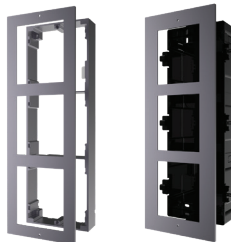

**3 Modules Flush Mount Frame**  
DS-KD-ACF3  
DS-KD-ACF3/Plastic



**1 Modular Surface Mount Bracket**  
DS-KD-ACW1



**2 Modular Surface Mount Bracket**  
DS-KD-ACW2



**3 Modular Surface Mount Bracket**  
DS-KD-ACW3

## Communication with Robust Security

### Key features:

- 2 MP 180-degree camera provides clear, wide field of view
- Built-In IR illuminates view in various lighting conditions
- Integrates with Hikvision recorders for easy access to live view, recording and playback
- Visitors can leave messages when users aren't home thanks to the built-in memory in indoor stations
- Illuminated nametag buttons provide better visibility at night
- IP and Two-Wire Outdoor Station can function as a security camera and work with Hikvision DVRs and NVRs



## Push Notifications and Remote Monitoring

### Supports Hik-Connect App Mobile Connectivity:

- When an indoor station receives a call, information can be sent to a mobile device
- User can answer a call on the app at any time, from anywhere.
- When a visitor is welcome, the user can press a button on the app to remotely open the door
- The user can access the door station camera for voluntary monitoring
- In the case of an unwelcome visitor, the user can remotely ask them to leave.

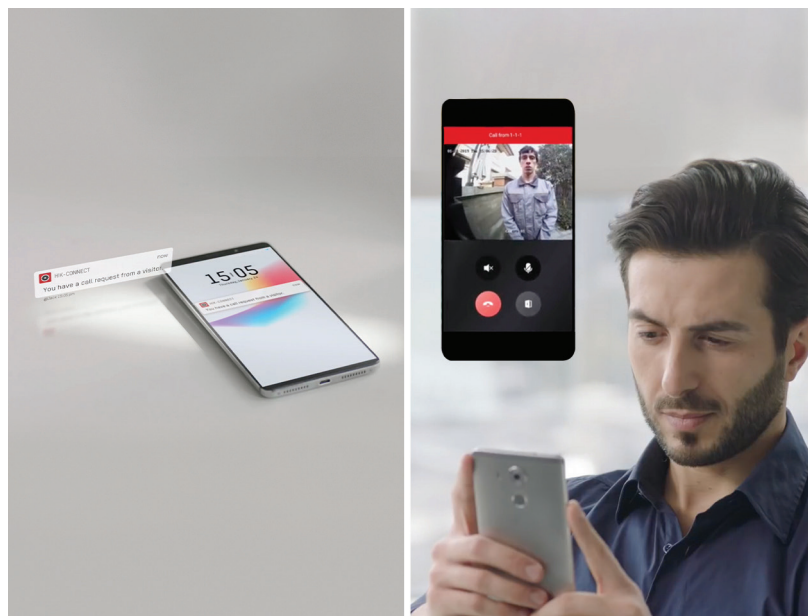

## Call Privacy and Multi-Door Entrances

### Key features:

- Video Call-In-Action with mute button for privacy enables easy communication
- Capable of controlling two doors for simple management at properties with multi-door entrances

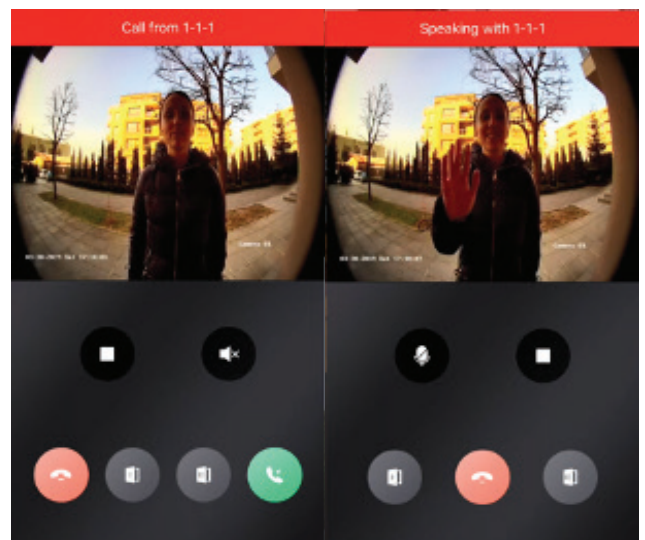



## High Definition Video Intercom

### Key features:

- High Performance IP Camera for excellent visual quality 2 MP video resolution
- Wide 180-Degree Lens, WDR and Night Vision for great quality 24/7
- High definition video is maintained even under harsh background lighting or at night

### FOUR STEP STARTUP WIZARD

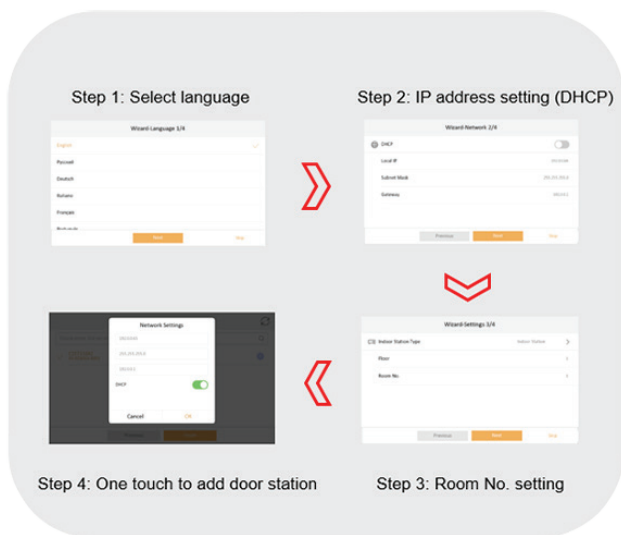

## Easy Setup Indoor Station

### Hikvision 2nd generation intercom allows integrators to:

- Set up the intercom system without using a computer.
- Activate and configure the outdoor station IP address easily using the indoor station touch screen
- Assign the apartment number on each indoor station from the startup wizard, making setup very easy

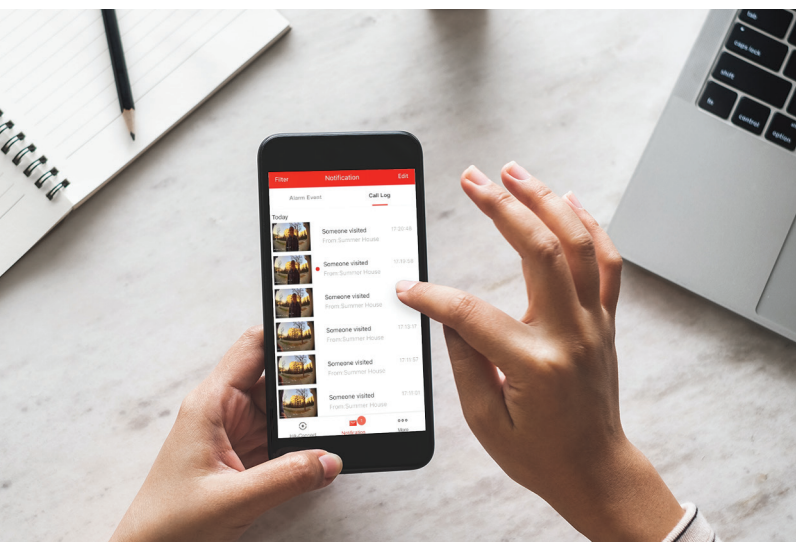

## Easy Access Call Log and Event History

### Key features:

- Easy access to call log with video playback and snapshot of visitor(s)
- Missed call tracking with time stamp easy to view in the Hikvision app
- Good visual representation with thumbnail image to see who visited and at what time from the "Call Log"
- App is intuitive, easy to use and hosts records for convenient review

## Room-To-Room Communication

### Key features:

- The Indoor Station functions as an IP phone and supports one-touch quick dialing to any other Indoor Station
- Visitors can call the Indoor Station with the Exterior Door Station
- Configure Indoor Station to transmit audio and video when answering a call
- The Indoor Station can be used to open the door remotely
- Users can choose to monitor the exterior camera from the Indoor Station
- In the case of a suspicious person, the intercom can be safely used to warn the person to leave



## Surveillance Camera Integration

### Key features:

- 7-inch Indoor Station integrates with Hikvision security cameras
- It enables users to view cameras on the property

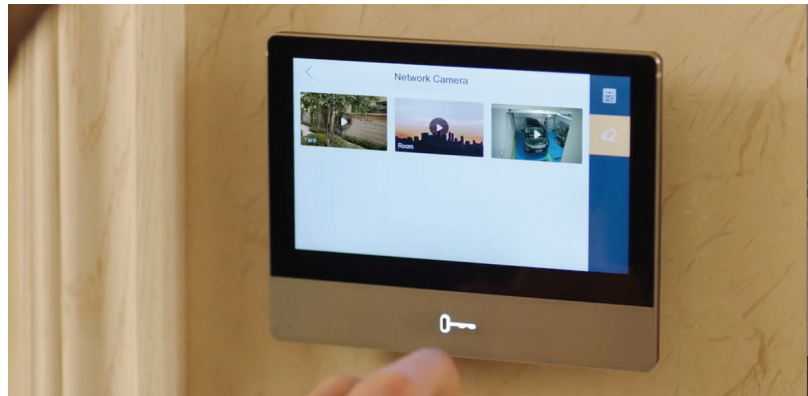

## Noise Suppression and Echo Cancellation

### Key features:

- Prevents common noise and echo problems that plague traditional intercoms: During remote intercom connections, traditional intercom microphones often pick up sounds and create feedback and echo, which distorts audio quality
- Hikvision intercom products use both hardware and software processing to solve the problems associated with audio, delivering clear intercom communication

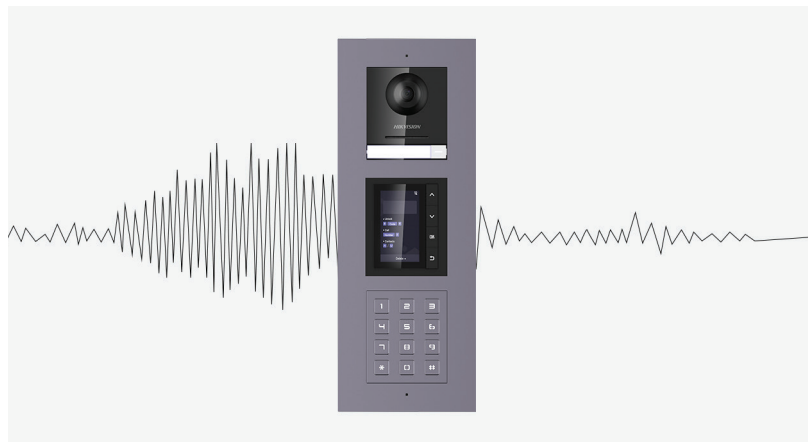

## SIP Phone Integration

### New feature that works with Hikvision's 2nd Generation Intercom:

- Equipped with standard SIP Protocol
- Use VOIP devices to speak with visitors and unlock the door





# Multi-Tenant Buildings

Hikvision offers a wide-range of technologies for various application needs. IP solutions with the standard PoE design are simple-to-use and convenient, especially for new construction. For older multi-tenant buildings that lack proper network infrastructure, Hikvision's two-wire solution enables reuse of existing wiring to upgrade to HD quality at a lower cost.

Multiple door stations can be installed for one building and residents can unlock them using a card or password. The apartment solution supports up to 500 apartment units, with communication available among all of them. The security camera function enables residents to live-view cameras within the building.



## Apartment Ultra Series Indoor Station (7-inch)

- IPS touch screen
- Award-winning design
- Live view for IP camera
- Automatic image capture for missed call
- Standard PoE



## Apartment Pro Series Indoor Station (7-inch)

- Touch screen
- Live view for IP camera
- Automatic image capture for missed call
- Standard PoE



## Side Entrance Main Module + Card Reader + Keypad

- Fisheye camera
- Night vision
- Unlock door by password or card
- Record video to CCTV system
- One touch call Mobile App and indoor stations

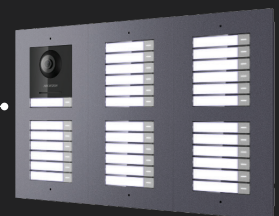

## Main Entrance Main Module + Nametag

- Fisheye camera
- Night vision
- Record video to CCTV system
- One touch call Mobile App and indoor stations



## Main Entrance Network Camera

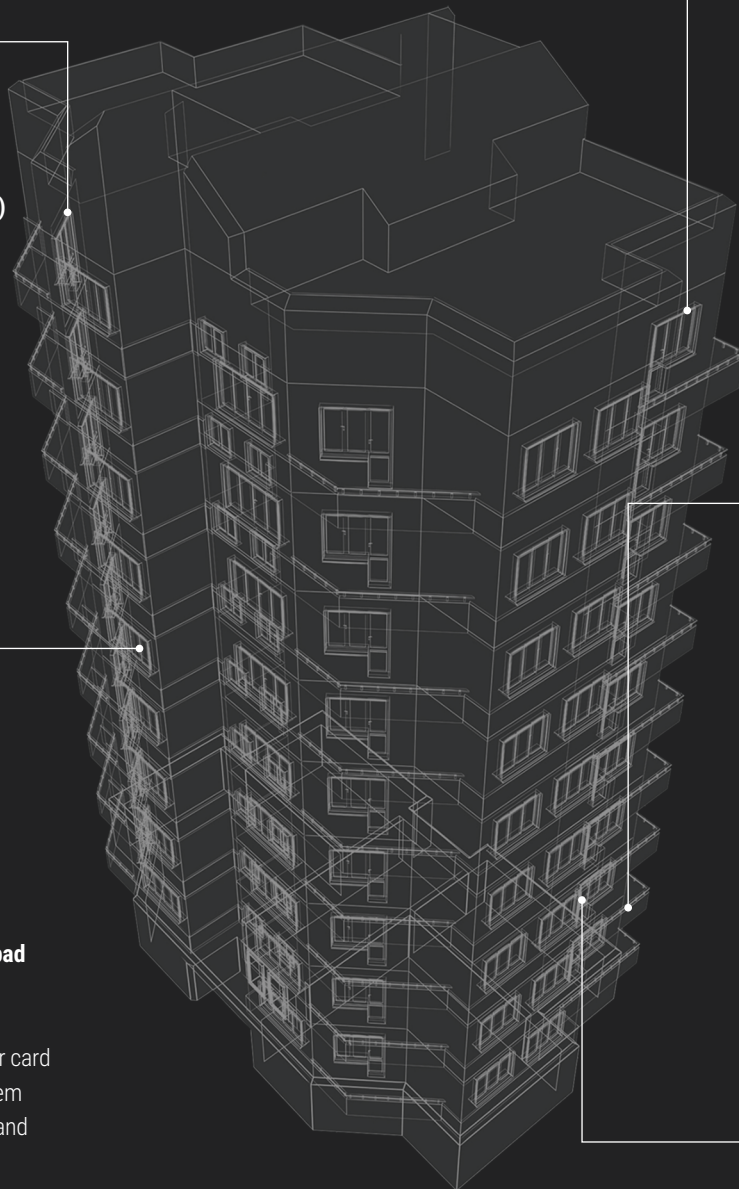

# New and Retrofit Apartment Solution

For new apartments, Hikvision's IP solution based on standard PoE design is simple and convenient. For older buildings that lack proper network infrastructure, the two-wire solution allows integrators to reuse existing wiring. Multiple door stations can be installed for one building and residents can unlock them using a card or passcode. Hikvision 2nd Generation Intercom solution offers a hybrid solution where the two-wire model can be used to upgrade using existing wiring. And, the IP intercom indoor station can be used for new units when applicable, combining the two-wire and IP intercom systems.

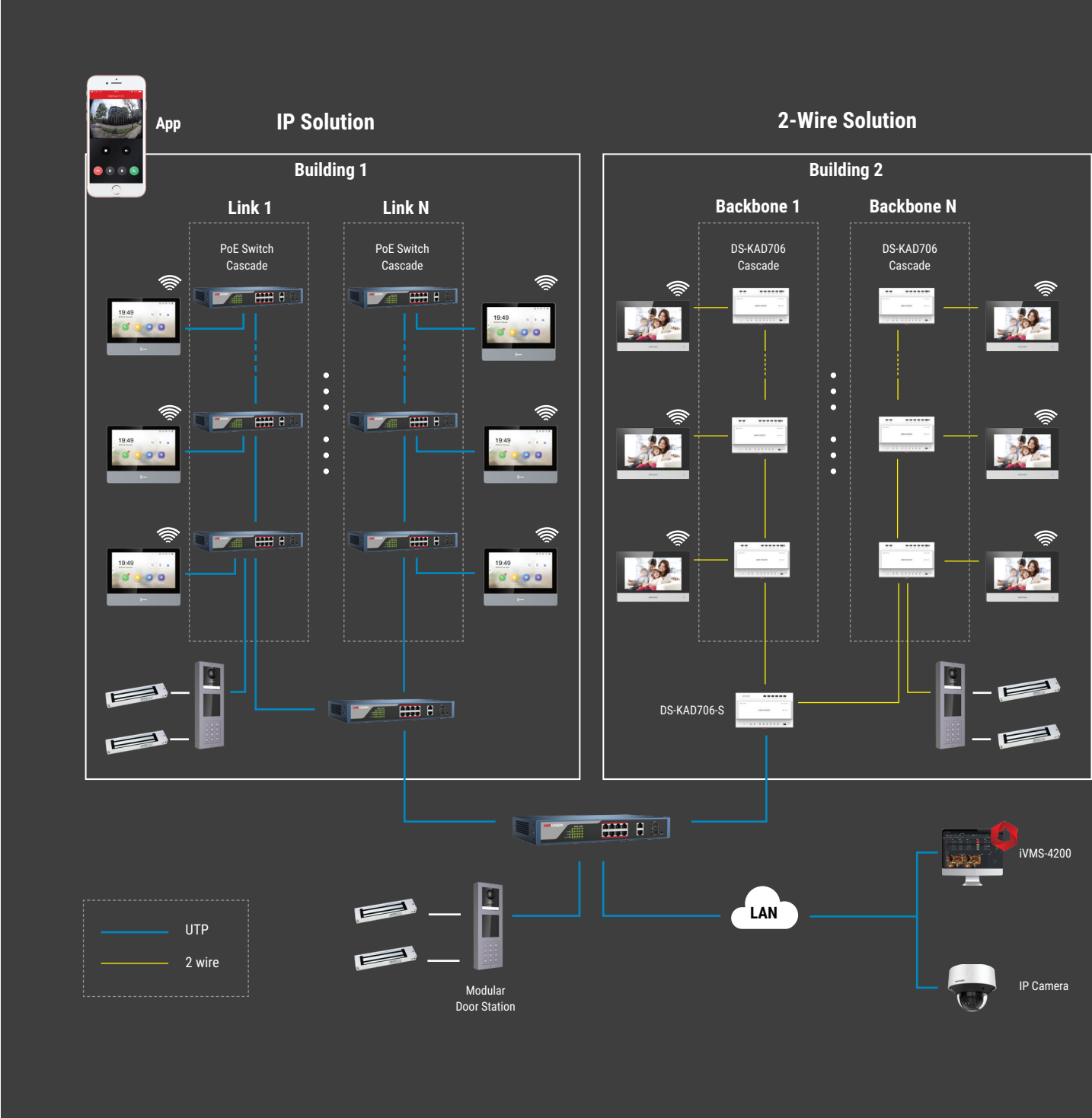

# Single Family Solution

The single family intercom solution provides thoughtful, useful functions for every member of the home. Users can call multiple indoor stations at the same time and unlock a door at any of the indoor stations, providing room-to-room communication on top of the standard intercom function. They can also receive all call information and unlock doors remotely and conveniently using the mobile app.

Using Hikvision's fisheye camera on the door station renders clear images day and night. With the record-to-NVR/DVR function, users can check on what's happening at their doorstep. To make this system even better, integrate it with Hikvision's security cameras, allowing indoor stations to display any IP camera installed in your house. Security and convenience come together in this solution for single family homes.



**Apartment  
Ultra Series Indoor Station (7-inch)**

- IPS touch screen
- Award-winning design
- Live view for IP camera
- Automatic image capture for missed call
- Standard PoE



**Apartment  
Ultra Series Indoor Station (7-inch)**

- IPS touch screen
- Award-winning design
- Live view for IP camera
- Automatic image capture for missed call
- Standard PoE



**Perimeter  
Network Camera**

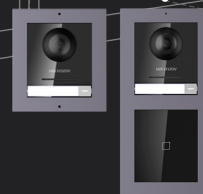
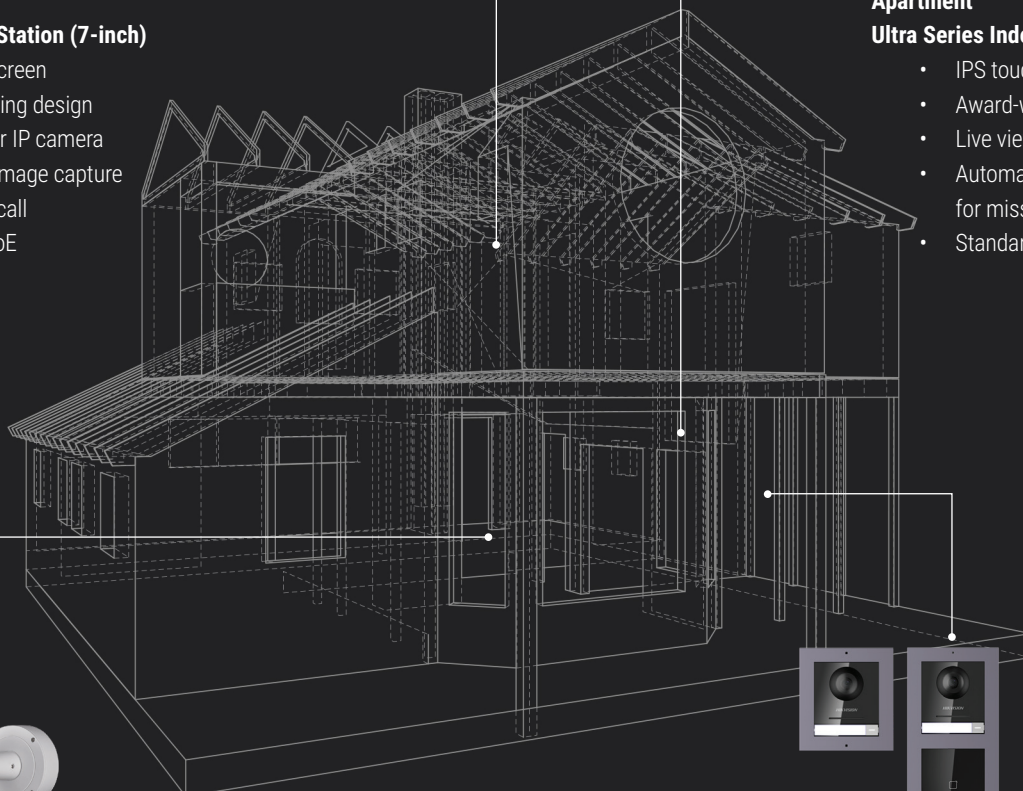

**Door  
Main Module or Main Module + Card Reader**

- Fisheye camera
- Night vision
- Unlock door by card
- Record video to CCTV system
- One touch call Mobile App and indoor stations

# Ease of Management

Free iVMS-4200 and Hik-Connect applications enable flexible system management. Hikvision's 2nd Generation Intercom system can be easily managed by iVMS-4200 for no additional cost, allowing users to manage both intercom and access control with one software. Hik-Connect allows users to answer calls, control the door remotely, and can be shared with family members.



## Mobile Application



### Key features:

- Control door remotely with the Hik-Connect mobile app
- Check and playback call log and video while away
- Manage home security solution with one free app
- Maintain and adjust basic functions using the mobile app
- Share the account with family members

## Central Management Software



### Key features:

- Free applications manage all Hikvision devices
- Modular system to select application features you need
- Video surveillance, intercom and access control modules available
- Event notifications for instant monitoring
- Single database manages all access control devices

# Transmission Distance

When Modular Door Station and Indoor Stations are powered by a standalone power supply, the power line cable distance is:

Cable specification	18 AWG	20 AWG	24 AWG
DS-KH8350 series	164 ft (50 m)	98 ft (30 m)	49 ft (15 m)
DS-KH8520WTE1 series	164 ft (50 m)	98 ft (30 m)	49 ft (15 m)
DS-KH6320 series	164 ft (50 m)	98 ft (30 m)	49 ft (15 m)
1 main unit + 7 extension modules	115 ft (35 m)	82 ft (25 m)	26 ft (8 m)

\*Note: The data transmission distance between Modular Door Station and switch, as well as between Indoor Stations, is 328 ft (100 m). This result is for reference only, actual distance may vary.

When Modular Door Station and Indoor Station are powered by standard PoE switch, the transmission distance is:

Cable specification	1LN5EU-G/CCA	1LN5E-S	1LN6-UU
DS-KH8350 series	328 ft (100 m)	328 ft (100 m)	328 ft (100 m)
DS-KH8520WTE1 series	328 ft (100 m)	328 ft (100 m)	328 ft (100 m)
DS-KH6320 series	328 ft (100 m)	328 ft (100 m)	328 ft (100 m)
1 main unit + 7 extension modules	197 ft (60 m)	262 ft (80 m)	328 ft (100 m)

\*Note: The above data are obtained by tests using Hikvision Cable and under the situation of one Door Station and one Indoor Station. This result is for reference only, actual distance may vary.

## Long Transmission Distance

Cable specification	24 AWG (0.2 mm <sup>2</sup> , 9 Ω/100 m) Twisted pair	20 AWG (0.5 mm <sup>2</sup> , 3.5 Ω/100 m) Twisted pair	18 AWG (0.8 mm <sup>2</sup> , 2.5 Ω/100m) Twisted pair	16 AWG (1 mm <sup>2</sup> , 1.5 Ω/100 m) Twisted pair	24 AWG (0.2 mm <sup>2</sup> , 9 Ω/100m) Parallel lines	20 AWG (0.5 mm <sup>2</sup> , 3.5 Ω/100m) Parallel lines	18 AWG (0.8 mm <sup>2</sup> , 2.5 Ω/100m) Parallel lines	16 AWG (1 mm <sup>2</sup> , 1.5 Ω/100m) Parallel lines
DS-KAD706-SP to DS-KAD706-P	≤197 ft (≤60 m)	≤197 ft (≤60 m)	≤197 ft (≤60 m)	≤164 ft (≤50 m)	N/A	≤115 ft (≤35 m)		N/A
DS-KAD706-P to DS-KAD706-P	≤197 ft (≤60 m)	≤197 ft (≤60 m)	≤197 ft (≤60 m)	≤164 ft (≤50 m)	N/A	≤115 ft (≤35 m)		N/A
DS-KAD706-P to DS-KD8003-IME2	≤115 ft (≤35 m)	≤197 ft (≤60 m)	≤197 ft (≤60 m)	≤164 ft (≤50 m)	N/A	≤115 ft (≤35 m)		N/A
DS-KAD706-P to DS-KH6320-WTE2	≤115 ft (≤35 m)	≤328 ft (≤100 m)	≤328 ft (≤100 m)	≤328 ft (≤100 m)	≤164 ft (≤50 m)	≤328 ft (≤100 m)	≤328 ft (≤100 m)	≤328 ft (≤100 m)

# Dimensional Reference for Installation

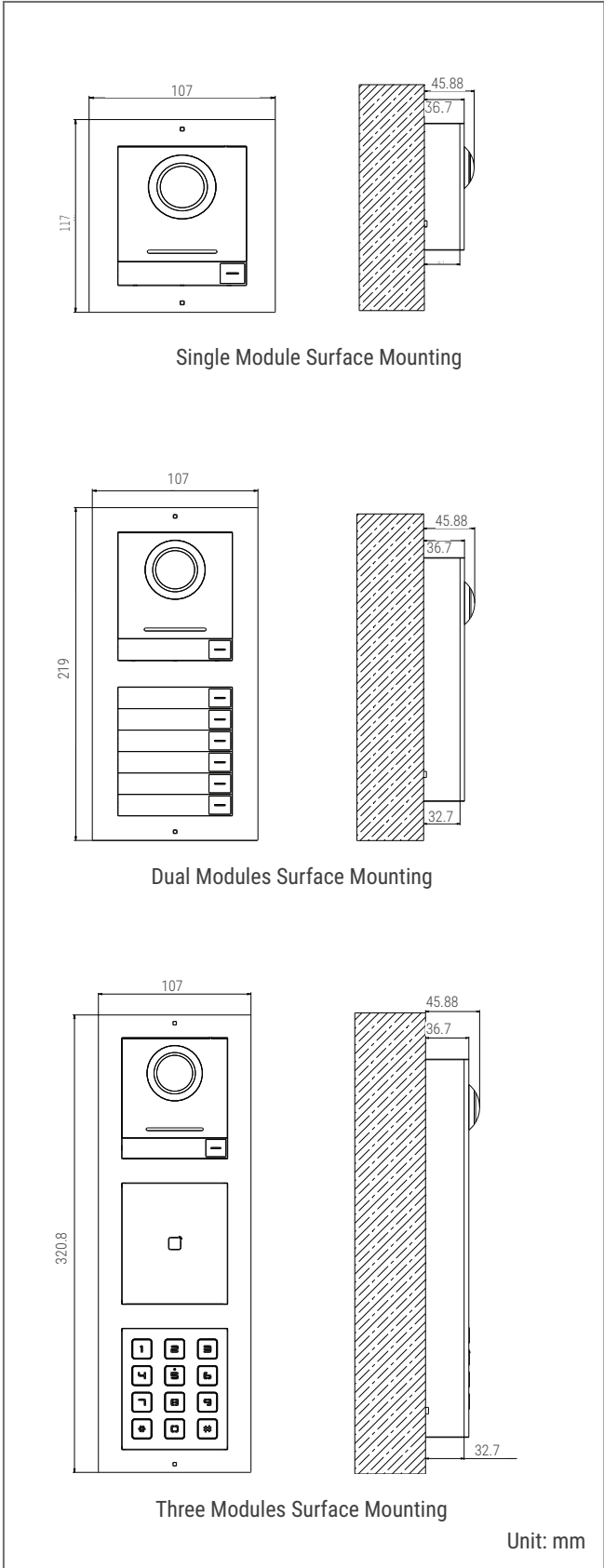
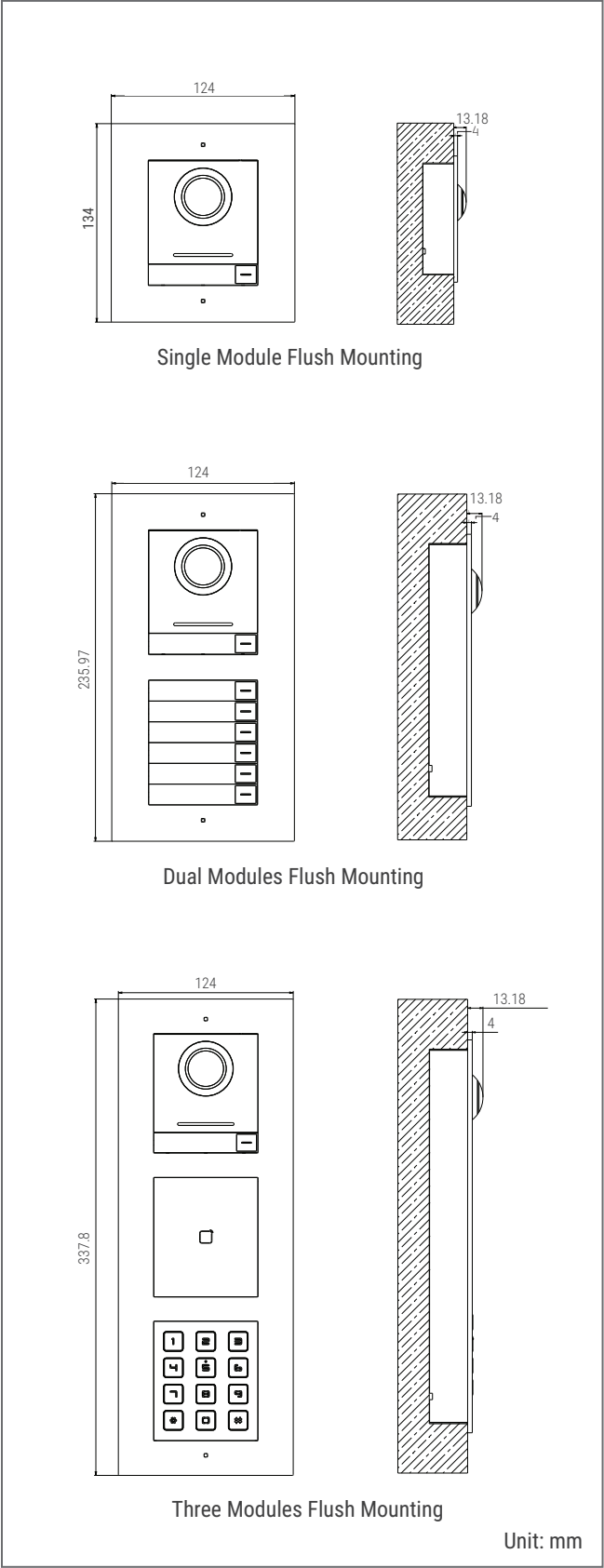

**Hikvision USA Inc.**  
18639 Railroad Street  
City of Industry, CA 91748

**Hikvision Canada Inc.**  
4848 Levy Street  
Saint-Laurent, Quebec H4R 2P1

**Contact Information**  
Toll-Free: +1 866-200-6690 (U.S. and Canada)  
Phone: +1 909-895-0400  
Email: [sales.usa@hikvision.com](mailto:sales.usa@hikvision.com)  
**[hikvision.com](http://hikvision.com)**

Connect with us: [!\[\]\(feabb98897b440bc8695a03336a6e2df\_img.jpg\)](#) [!\[\]\(c7f935293d8062fa748ed86b74d28761\_img.jpg\)](#) [!\[\]\(7fb6629225c12ebb64040d8c4514d4ad\_img.jpg\)](#) [!\[\]\(b212b60c262469e8f45d74900bdab300\_img.jpg\)](#) [!\[\]\(82425dedfebd07236c346574c63bc289\_img.jpg\)](#)

©2020 Hikvision USA Inc. and Hikvision Canada Inc. All rights reserved. Hikvision is a registered trademark of Hikvision Digital Technology Co., Ltd. in the US, Canada and other countries. All other trademarks, service marks, and product or service names are trademarks or registered trademarks of their respective owners. Product specifications and availability are subject to change without Notice.