

THC-T229-M 2 MP ColorVu Fixed Turret Camera



- High quality imaging with 2 MP, 1920 × 1080 resolution
- 24/7 color imaging with F1.0 aperture
- 3D DNR technology delivers clean and sharp images
- 2.8 mm, 3.6 mm, 6 mm fixed focal lens
- Up to 40 m white light distance for bright night imaging
- One port for four switchable signals (TVI/AHD/CVI/CVBS)
- Water and dust resistant (IP66)

▪ Specification

Camera	
Image Sensor	2 MP CMOS
Signal System	PAL/NTSC
Resolution	1920 (H) × 1080 (V)
Frame Rate	TVI: 1080p@25fps/30fps CVI: 1080p@25fps/30fps AHD:1080p@25fps/30fps CVBS: PAL/NTSC
Min. Illumination	0.001 Lux @ (F1.0, AGC ON), 0 Lux with white light
Shutter Time	PAL: 1/25 s to 1/50,000 s; NTSC: 1/30 s to 1/50,000 s
Lens	2.8 mm/3.6 mm/6 mm fixed lens
Field of View	2.8 mm, horizontal FOV: 102°, vertical FOV: 54°, diagonal FOV: 121° 3.6 mm, horizontal FOV: 80°, vertical FOV: 43°, diagonal FOV: 95° 6 mm, horizontal FOV: 52°, vertical FOV: 29°, diagonal FOV: 61°
Lens Mount	M12
Light Alarm	Flashing Light Alarm (White Light), Solid Light Alarm (White Light)
Day & Night	Color
WDR (Wide Dynamic Range)	Digital WDR
Angle Adjustment	Pan: 0° to 360°, Tilt: 0° to 75°, Rotation: 0° to 360°
Menu	
White Light	Auto/Off
Image Mode	STD/HIGH-SAT/HIGHLIGHT
AGC	Yes
Day/Night Mode	Color
White Balance	Auto/Manual
AE (Auto Exposure) Mode	DWDR, BLC, HLC, Global
Noise Reduction	3D DNR/2D DNR
Language	English
Function	Brightness, Contrast, Mirror, Defective Pixel Correction, Sharpness, Anti-Banding, Smart Light
Lighting Mode	White Light
Interface	
Video Output	Switchable TVI/AHD/CVI/CVBS
General	
Operating Conditions	-40°C to 60°C (-40°F to 140°F), Humidity: 90% or less (non-condensing)
Power Supply	12 VDC ± 25% <i>*You are recommended to use one power adapter to supply the power for one camera.</i>
Consumption	Max. 4 W
Protection Level	IP66
Material	Metal
White Light Range	Up to 40 m
Dimension	Φ 127.92 mm × 100.97 mm (Φ 5.04" × 3.98")
Weight	Approx. 478.5 g (1.05 lb.)

▪ Dimension

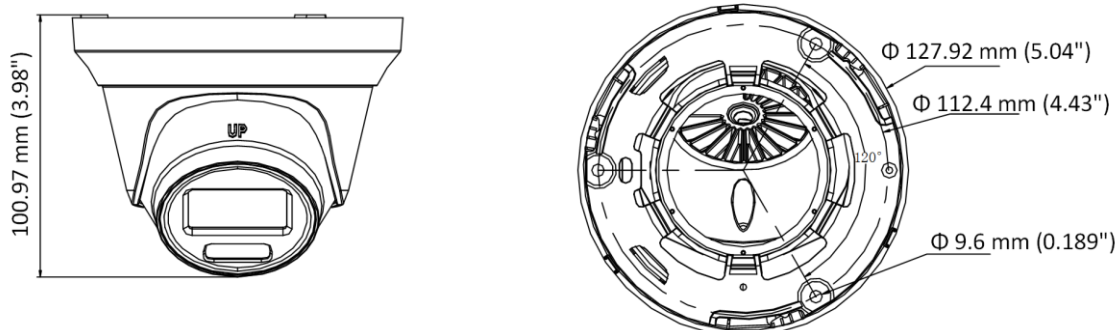

▪ Accessory

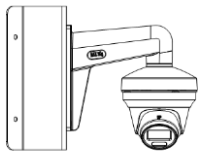
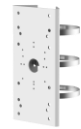

HIA-B201

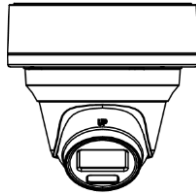

HIA-J103

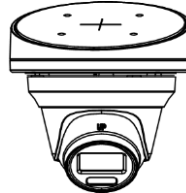

HIA-J202

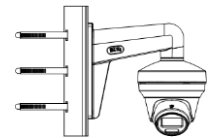

HIA-B301

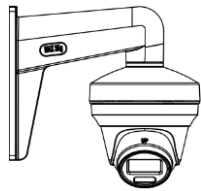

HIA-B402-130T

▪ Available Model

THC-T229-M