



Interactive Tablet

User Manual

Legal Information

©2019 Hangzhou Hikvision Digital Technology Co., Ltd. All rights reserved.

About this Manual

The Manual includes instructions for using and managing the Product. Pictures, charts, images and all other information hereinafter are for description and explanation only. The information contained in the Manual is subject to change, without notice, due to firmware updates or other reasons. Please find the latest version of this Manual at the Hikvision website (<https://www.hikvision.com/en/>).

Please use this Manual with the guidance and assistance of professionals trained in supporting the Product.

Trademarks

HIKVISION and other Hikvision's trademarks and logos are the properties of Hikvision in various jurisdictions.

Other trademarks and logos mentioned are the properties of their respective owners.

Disclaimer

TO THE MAXIMUM EXTENT PERMITTED BY APPLICABLE LAW, THIS MANUAL AND THE PRODUCT DESCRIBED, WITH ITS HARDWARE, SOFTWARE AND FIRMWARE, ARE PROVIDED “AS IS” AND “WITH ALL FAULTS AND ERRORS”. HIKVISION MAKES NO WARRANTIES, EXPRESS OR IMPLIED, INCLUDING WITHOUT LIMITATION, MERCHANTABILITY, SATISFACTORY QUALITY, OR FITNESS FOR A PARTICULAR PURPOSE. THE USE OF THE PRODUCT BY YOU IS AT YOUR OWN RISK. IN NO EVENT WILL HIKVISION BE LIABLE TO YOU FOR ANY SPECIAL, CONSEQUENTIAL, INCIDENTAL, OR INDIRECT DAMAGES, INCLUDING, AMONG OTHERS, DAMAGES FOR LOSS OF BUSINESS PROFITS, BUSINESS INTERRUPTION, OR LOSS OF DATA, CORRUPTION OF SYSTEMS, OR LOSS OF DOCUMENTATION, WHETHER BASED ON BREACH OF CONTRACT, TORT (INCLUDING NEGLIGENCE), PRODUCT LIABILITY, OR OTHERWISE, IN CONNECTION WITH THE USE OF THE PRODUCT, EVEN IF HIKVISION HAS BEEN ADVISED OF THE POSSIBILITY OF SUCH DAMAGES OR LOSS.

YOU ACKNOWLEDGE THAT THE NATURE OF INTERNET PROVIDES FOR INHERENT SECURITY RISKS, AND HIKVISION SHALL NOT TAKE ANY RESPONSIBILITIES FOR ABNORMAL OPERATION, PRIVACY LEAKAGE OR OTHER DAMAGES RESULTING FROM CYBER-ATTACK, HACKER ATTACK, VIRUS INSPECTION, OR OTHER INTERNET SECURITY RISKS; HOWEVER, HIKVISION WILL PROVIDE TIMELY TECHNICAL SUPPORT IF REQUIRED.

YOU AGREE TO USE THIS PRODUCT IN COMPLIANCE WITH ALL APPLICABLE LAWS, AND YOU ARE SOLELY RESPONSIBLE FOR ENSURING THAT YOUR USE CONFORMS TO THE APPLICABLE LAW. ESPECIALLY, YOU ARE RESPONSIBLE, FOR USING THIS PRODUCT IN A MANNER THAT DOES NOT INFRINGE ON THE RIGHTS OF THIRD PARTIES, INCLUDING WITHOUT LIMITATION, RIGHTS OF PUBLICITY, INTELLECTUAL PROPERTY RIGHTS, OR DATA PROTECTION AND OTHER PRIVACY RIGHTS. YOU SHALL NOT USE THIS PRODUCT FOR ANY PROHIBITED END-USES, INCLUDING THE DEVELOPMENT OR PRODUCTION OF WEAPONS OF MASS DESTRUCTION, THE DEVELOPMENT OR

Interactive Tablet User Manual

PRODUCTION OF CHEMICAL OR BIOLOGICAL WEAPONS, ANY ACTIVITIES IN THE CONTEXT RELATED TO ANY NUCLEAR EXPLOSIVE OR UNSAFE NUCLEAR FUEL-CYCLE, OR IN SUPPORT OF HUMAN RIGHTS ABUSES.

IN THE EVENT OF ANY CONFLICTS BETWEEN THIS MANUAL AND THE APPLICABLE LAW, THE LATER PREVAILS.

Regulatory Information

FCC Information

Please take attention that changes or modification not expressly approved by the party responsible for compliance could void the user's authority to operate the equipment.

FCC compliance: This equipment has been tested and found to comply with the limits for a Class B digital device, pursuant to part 15 of the FCC Rules. These limits are designed to provide reasonable protection against harmful interference in a residential installation. This equipment generates, uses and can radiate radio frequency energy and, if not installed and used in accordance with the instructions, may cause harmful interference to radio communications. However, there is no guarantee that interference will not occur in a particular installation. If this equipment does cause harmful interference to radio or television reception, which can be determined by turning the equipment off and on, the user is encouraged to try to correct the interference by one or more of the following measures:

- Reorient or relocate the receiving antenna.
- Increase the separation between the equipment and receiver.
- Connect the equipment into an outlet on a circuit different from that to which the receiver is connected.
- Consult the dealer or an experienced radio/TV technician for help.

FCC Conditions

This device complies with part 15 of the FCC Rules. Operation is subject to the following two conditions:

1. This device may not cause harmful interference.
2. This device must accept any interference received, including interference that may cause undesired operation.

EU Conformity Statement



This product and - if applicable - the supplied accessories too are marked with "CE" and comply therefore with the applicable harmonized European

standards listed under the EMC Directive 2014/30/EU, the RoHS Directive 2011/65/EU.



2012/19/EU (WEEE directive): Products marked with this symbol cannot be disposed of as unsorted municipal waste in the European Union. For proper recycling, return this product to your local supplier upon the purchase of equivalent new equipment, or dispose of it at designated collection points. For more information see: <http://www.recyclethis.info>.



2006/66/EC (battery directive): This product contains a battery that cannot be disposed of as unsorted municipal waste in the European Union. See the product documentation for specific battery information. The battery is marked with this symbol, which may include lettering to indicate cadmium (Cd), lead (Pb), or mercury (Hg). For proper recycling, return the battery to your supplier or to a designated collection point. For more information see: <http://www.recyclethis.info>.

Industry Canada ICES-003 Compliance

This device meets the CAN ICES-3 (B)/NMB-3(B) standards requirements.



Preface

Applicable Models

This manual is applicable to interactive tablet (hereafter referred to the device).

Symbol Conventions

The symbols that may be found in this document are defined as follows.

Symbol	Description
 Danger	Indicates a hazardous situation which, if not avoided, will or could result in death or serious injury.
 Caution	Indicates a potentially hazardous situation which, if not avoided, could result in equipment damage, data loss, performance degradation, or unexpected results.
 Note	Provides additional information to emphasize or supplement important points of the main text.

Safety Instructions

Caution

- Do not place the device in direct strong lighted, humid, over-heated/cooled, dusty environment.
- Do not place the device in an environment where flammable and explosive matter are stored and used.
- Do not place the device in an environment of flammable and corrosive gas.
- Do not place the device in places like bathroom and kitchen.
- Do not use damaged or unfit power socket. Make sure the plug and the socket are in good contact.
- Do not parallel multiple plugs in one socket to avoid fire risk caused by power overload.
- Do not approach the device with fire (e.g. a lit candle) to avoid the risk of fire or electric shock.
- Do not place anything containing liquid on the device to avoid the risk of fire or electric shock caused by liquid-splashing.
- Do not let sharp or metal articles and liquids contact the signal connectors or heat dissipation holes to avoid short circuit, product damage and electric shock.
- The hole on the shell is designed for heat dissipation. Do not block the hole when installing the device.

- Do not touch the device with a wet finger to avoid risk of electric shock.
- Do not operate the device in heavy rain, especially lightning weather to avoid electric shock. Contact professional technicians for repairing.



Warning

- Do not let children climb onto the device.
- Keep small accessories away from children.
- If the device will not be used for a long time. Shut down the power of the device and disconnect the power supply.
- To avoid the risk of electric shock, please do not operate when the power is on.
- Please do not plug and unplug the power cable frequently.
- Make sure the power supply matches the requirements specified by the plate on the shell.
- After the environment temperature changed from low to high. Wait for a period of time before powering on the device.
- Make sure the environment is dry and well-ventilated, and heat dissipation is good.
- Turn down the volume when using earphones.
- This is a class A product and may cause radio interference in which case the user may be required to take adequate measures.

Contents

Chapter 1 Introduction	1
Chapter 2 Operation and Maintenance Precautions	2
2.1 Use of Power Cable	2
2.2 Cleaning and Maintenance	3
Chapter 3 Connection and Installation	4
3.1 Precautions for Installation	4
3.2 Appearance and Interfaces	4
3.3 Connection to Personal Computer (PC)	7
3.3.1 VGA Connection	7
3.3.2 HDMI Connection	8
3.4 Computer Installation	8
3.5 Mounting	9
Chapter 4 Startup and Shutdown	12
4.1 Device Startup	12
4.1.1 Installed Without a Computer Box	12
4.1.2 Installed with a Computer Box	12
4.2 Eco Mode	12
4.3 Shutdown	12
Chapter 5 Sidebar Operations	13
5.1 Basic Operations	13
5.2 Channel	14
5.3 Control Menu	14
5.4 Screenshot	15
5.5 Annotating	16
Chapter 6 System Settings	18
6.1 Network Settings	18

Interactive Tablet User Manual

6.1.1 Wired Network Settings	18
6.1.2 Wireless Network Settings	19
6.1.3 WLAN Hotspot Settings	21
6.2 Display Settings	22
6.3 Audio Settings	23
6.4 Language & Input Settings	24
6.5 Time & Date Settings	24
6.6 Application Management	25
6.7 Intelligent Temperature Control	26
6.8 Advanced Settings	27
6.8.1 Input Source Settings	28
6.8.2 Startup/Shutdown Settings	28
6.8.3 Wakeup Settings	28
6.8.4 HDMI Output Settings	29
6.8.5 USB Settings	29
6.9 Device Information	29
Chapter 7 Intelligent Applications	30
7.1 FileBrowser	30
7.2 Browser	31
7.3 System Preinstalled Applications	31
Appendix A. FAQs	33

Chapter 1 Introduction

The Interactive tablet (hereafter referred to as the “device”) integrates functions of computers, projectors, interactive whiteboards, sound boxes, cameras (optional), HDTVs, advertising machines and so on. The device integrates technologies like 4K display, infrared touch, human-machine interaction, multi-media information processing, and network transmission and provides users with various features such as writing, annotating, multi-screen sharing, and remote video call (optional).

The Interactive tablet is mainly used for remote video conferences, trainings and guidance, medical consulting, and other events in kinds of offices, meeting rooms, multi-media classrooms, exhibition halls and so on.

Key Features

- 4K display, and the resolution of the input signal is up to 3840 × 2160
- 20px ultra fine writing, and 1 mm writing in diameter recognizable
- Built-in Wi-Fi realizes wireless screen mirroring without any cable connection
- Built-in interactive whiteboard system allows annotating and sharing by scanning QR code
- Display looping out
- Various audio and video interfaces for device access
- Built-in network switch module saves a network switch
- Built-in Android system supports kinds of applications
- Compatible with OPS/OPS-C devices, and built-in systems can seamlessly switch between each other
- Ultrathin aluminum profile frame design

Chapter 2 Operation and Maintenance Precautions

The LCD panel on the device is made by high-precision technology. However, tiny spots on the screen that are always or never lit may be observed, or when observed from side, the color may and brightness may appear to be uneven. Yet the above phenomena are common among LCD displays rather than faults and will not affect the performance of the device.

- Our company is not responsible for any fault caused by third-party when operating the device and other failure or damage incurred.
- Do not operate the device in an environment of dust, high humidity, or oil and steam contacting to avoid the risk of fire and damage.
- Do not place the device under direct sunlight or near strong light source.
- Do not place the device near other equipment with strong radiation.
- Do not expose the device to rain or humid environment.
- Do not place the device on unstable or unsafe surface. Avoid strong impact, vibration or vibration.
- Do not operate the device near heating device or place of high temperature to avoid the risk of fire.
- After moving the device from low temperature environment to high temperature environment, please do not turn on the device immediately and wait for the condensation to evaporate.
- Do not insert any object into the device.
- Do not place heavy objects upon the device.
- The device and its accessories are subject to change without prior notice.
- The fragile materials of the display are vulnerable to falling and impact. Please hold with care.
- Improper operations during debugging and operating may cause damage to the device.
- Scratching or knocking the device with hard objects is strictly forbidden. Do not frequently turn on/off the power of the device when operating to avoid the risk of damage and faults.
- If smoke, odor or noise rise from the device, turn off the power at once and unplug the power cable, and then please contact the service center.

2.1 Use of Power Cable

- If the power cable is damaged or failed, contact service center. Make sure the power supply is properly grounded and matches the requirements specified by the plate on the shell.
- Do not expose the device to rain or humid environment. Disconnect power plug and antenna in thunderstorm weather.
- If the device will not be used for a long time. Shut down the power of the device and disconnect the power supply.
- Electric discharge may last for a short period of time after the power is shut down. Please wait for two minutes after the power shut down to operate the device.
- Only use the original power cable delivered with the device. Contact authorized dealer to purchase power cable with same specifications.

- Make sure the power supply is grounded.
- Do not let dust or metal attachment adhere to the power plug and socket.
- Do not modify the cable in any form.
- Do not place heavy object on the cable.
- Keep the cable away from heat.
- Do not disconnect the power plug by pulling the cable.
- Keep the power cable away from physical or mechanical damage.
- The cable is applicable only to the Interactive Display. Do not use it on other devices.

2.2 Cleaning and Maintenance

- The hole on the rear shell is for heat dissipation. Do not pour or spray liquid to the rear shell or use wet cloth for cleaning.
- Disconnect the power plug before cleaning.
- Do not display images with high brightness on the screen for too long.
- Use a dry, soft and dust-free cloth to clean the device.
- Contact service center for internal cleaning.
- Proper maintenance can avoid certain early-stage failures.
- Clean the device on a regular basis to make the device look new.
- Do not clean the device with water, spray cleaner or industrial chemical reagent. Prevent foreign matters from entering the device.
- Contact qualified service personnel for device maintenance. If the device is damaged, please contact our company, do not carry out unauthorized maintenance.

Chapter 3 Connection and Installation

3.1 Precautions for Installation

- Clean the device screen and back before installation for best performance.
- For safety, only use the wall mount or base provided by the manufacture.
- Contact professional staff for wall mounting.
- Check the accessories before the installation. Contact the dealer if anything is missing.
- Do not install the device too tight. Otherwise the screen may be distorted.
- Mount the device on load-bearing wall.
- Place the device on a stable surface or fix the device steadily on the wall.
- Install the device near an available AC power socket for easy power connection. Use the same ground cable with other devices to prevent signal interference.
- Do not place the device near mechanical vibration source.
- Do not place the device in an environment where insects have easy access.
- Do not let the device face the air conditioner directly to avoid condensing.
- Do not place the device in strong electromagnetic field to avoid radio interference.

3.2 Appearance and Interfaces

Front Panel and Back Panel

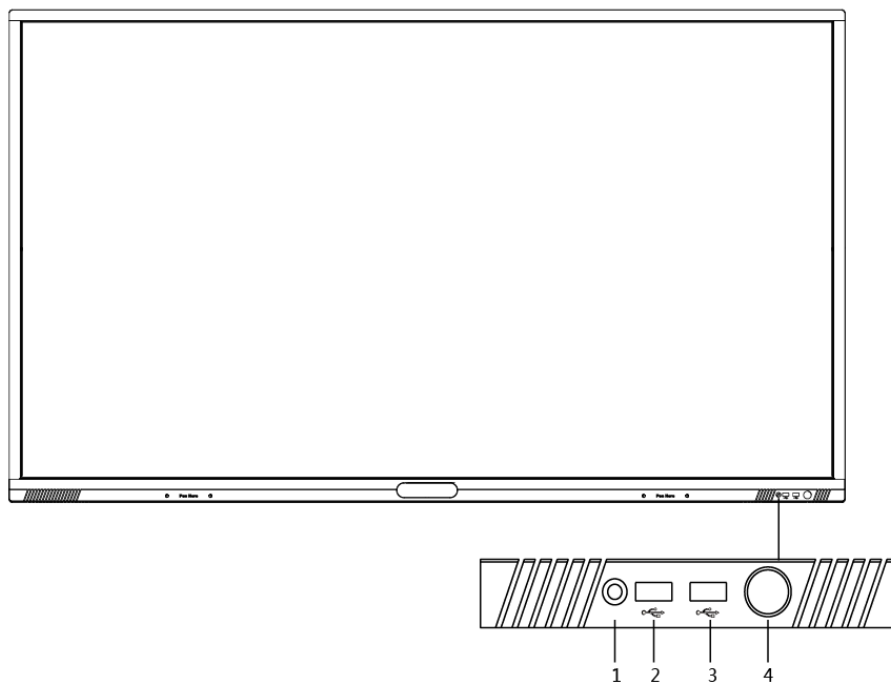

Figure 3-1 Front Panel

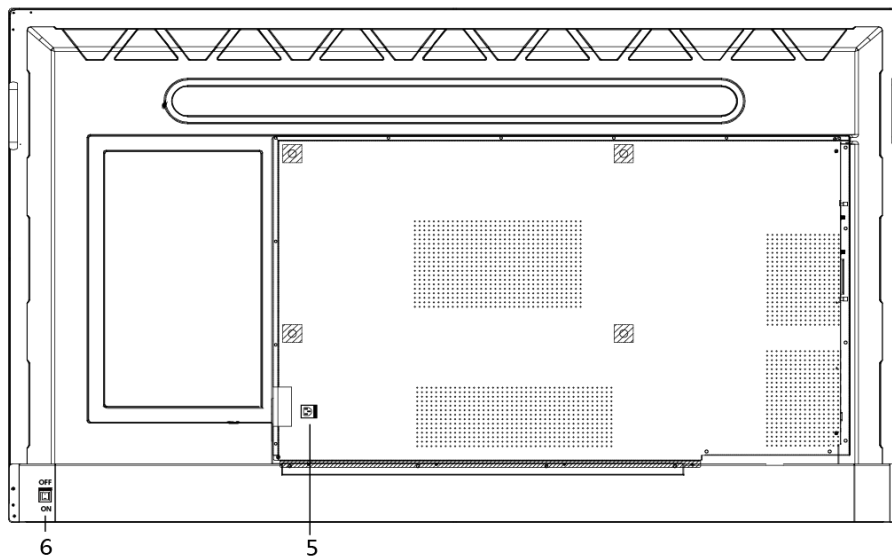



Figure 3-2 Back Panel

Table 3-1 Panel Description

No.	Interface	Function Description
1	☉	Light sensor
2-3	USB	Self-adaptive PC-USB and Android-USB
4	○	Power button Short press to go to power saving status. Long press to turn on or turn off the device.
5		Power interface
6		Power switch

Interfaces on Back Panel Bottom

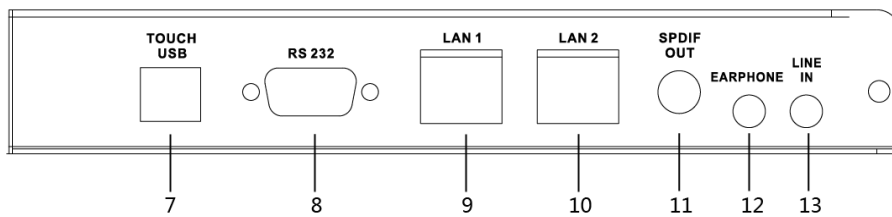

Figure 3-3 Interfaces on Back Panel Bottom

Table 3-2 Interface Description

No.	Interface	Function Description
7	TOUCH-USB	External touch interface
8	RS-232	RS-232 debug serial port
9	LAN 1	Network interface 1
10	LAN 2	Network interface 2
11	SPDIF OUT	Digital multimedia speaker interface
12	EARPHONE	Earphone output interface
13	LINE IN	Audio input interface

Interfaces on Back Panel Left

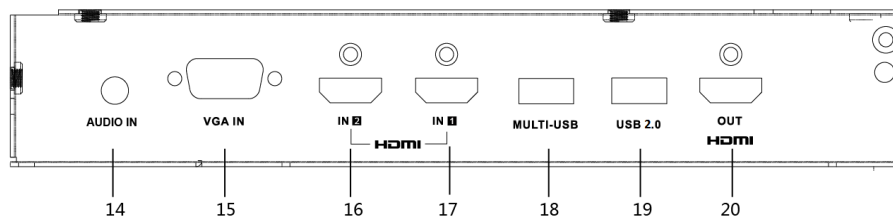

Figure 3-4 Interfaces on Back Panel Left

Table 3-3 Interface Description

No.	Interface	Function Description
14	AUDIO IN	Audio input interface
15	VGA IN	VGA input interface
16	HDMI IN2	HDMI2 input interface
17	HDMI IN1	HDMI1 input interface
18	MULTI-USB	PC-USB, Android-USB interface
19	USB 2.0	Android USB 2.0 interface
20	HDMI OUT	HDMI output interface

Note

- The appearance of different models under the same series may vary and is subject to change.
- The above interface positions are the relative positions when facing the screen.

3.3 Connection to Personal Computer (PC)

Warning

The device must be disconnected from power supply before installation and disassembly.

Note

- The Touch-USB interface is needed only when the user needs to touch operate the external PC on the device.
 - Use high quality signal cable less than 10 meters in length for high VGA or HDMI signal transmission quality.
 - USB cable is not contained in the product. Please purchase USB cable with type A connector to type B connector.
-

3.3.1 VGA Connection

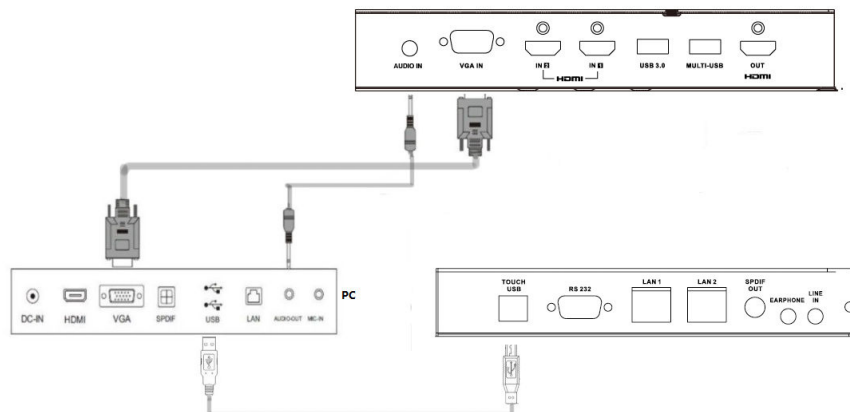

Figure 3-5 VGA Connection

3.3.2 HDMI Connection

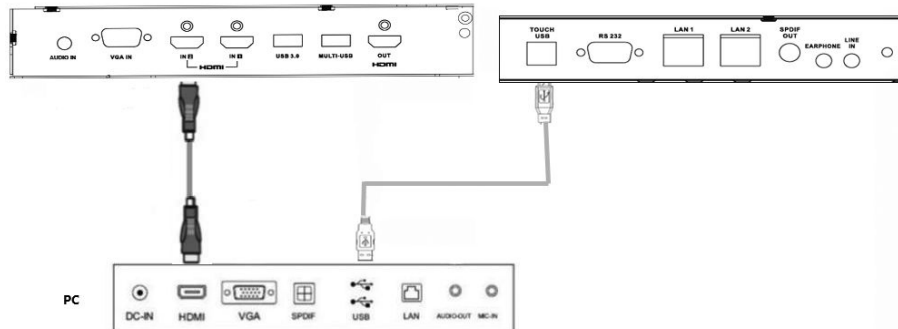

Figure 3-6 HDMI Connection

3.4 Computer Installation

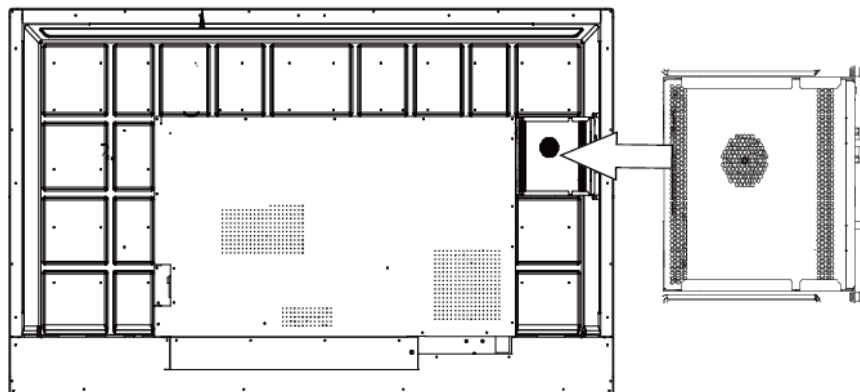

Figure 3-7 Computer Installation

The computer box is installed at the side slot of the device. When installing the box, make sure its ventilation hole is facing the same direction with the rear panel as shown above. Fasten the two side screws to fix the box into position.

Warning

- The computer is an optional accessory.
 - To avoid potential device damage, the computer box can be removed only after the device is disconnected from power.
-

3.5 Mounting

The device can be installed using wall mount or mobile mount, as shown below.

 **Note**

The accessories of wall mount and mobile mount are different. Do not mix them up.

Wall Mounting

The rear should be installed on the hook holes

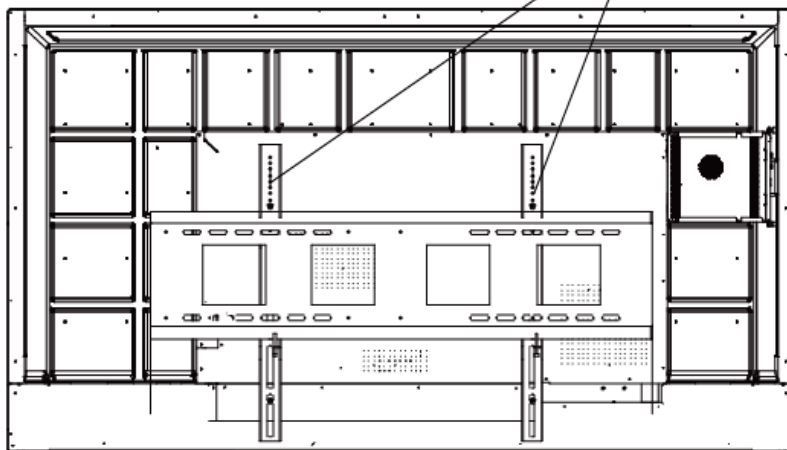

Figure 3-8 Wall Mount Front View

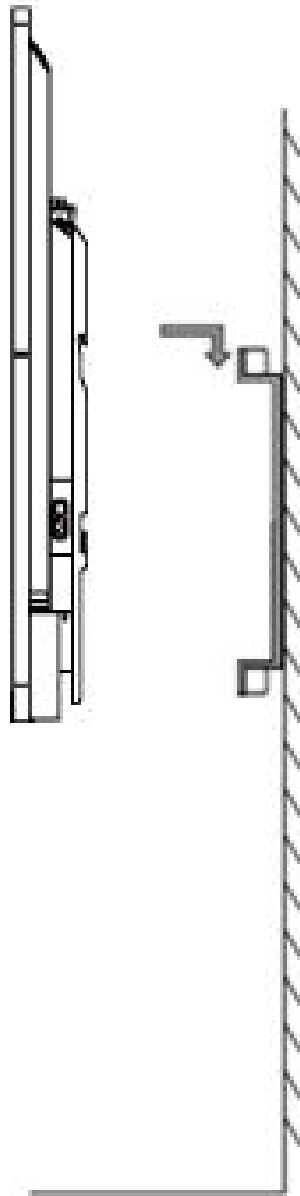

Figure 3-9 Wall Mount Side View

 **Note**

The wall mount is mobile horizontally. Please leave a space no less than 6 cm at each side, or a space no less than 12 cm at one side for maintenance service.

Mobile Mounting

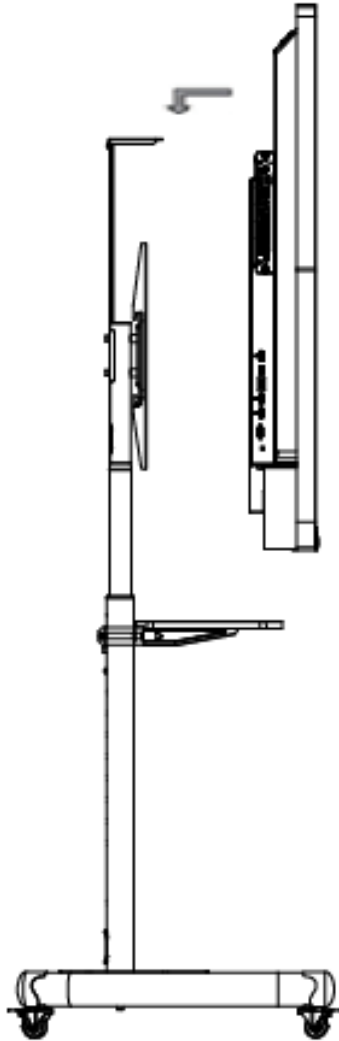

Figure 3-10 Mobile Mounting

Chapter 4 Startup and Shutdown

4.1 Device Startup

4.1.1 Installed Without a Computer Box

Steps

1. Connect the device to power supply.
2. Turn on the power switch, the power indicator on the front panel will turn red.
3. Push the **Power** button on the front panel to start up the device, the indicator will turn blue.

4.1.2 Installed with a Computer Box

Install the box when the device is disconnected from power and turn on the power after the installation is finished. During the startup, the power indicator of the box will turn red and the fan will start. After a beep sound, the power indicator will turn green and the computer box is started. Meanwhile, the power indicator of the front panel will turn blue which means the device is started.

4.2 Eco Mode

Entering Eco Mode

Press the Power button on the front panel to turned off the screen and enter the Eco mode.

Waking up the Device

Repeat the same operation again or touch anywhere on the screen to turn on the screen.

4.3 Shutdown

If the device is not installed with computer box which is shut down, directly switch off the power to shut down the device.

If the device is installed with computer box which is powered on. Tap **Start** and choose **Shutdown**, or press the **Power** button on the box to shut it down (press and hold the **Power** button to force shutdown). Then switch off the power to shut down the device.

Note

Switching off the power of the device directly leads to force shutdown of the computer box. Next time the device starts up, the Windows may enter error recovery mode and the touch screen will be disabled. Please access mouse and keyboard.

Chapter 5 Sidebar Operations

Note

Software interfaces and functions may vary with device model. All pictures in this manual are for illustration purpose only.

Turn on the device to go to the main page. Tap **»** or **«** to go to the sidebar. See the following figure for the descriptions of the icons.



Figure 5-1 Main Page

5.1 Basic Operations

Functions of the shortcut icons are described below.

Table 5-1 Icon Description

Icon	Function	Icon	Function
Back	Return to the previous page.	Home	Return to the main page.
Task	Display all the windows.	Tools	Open the control menu.
Channel	Select the input channel.	---	---

5.2 Channel

Tap **Channel** in the sidebar to select **PC**, **HDMI 1**, **HDMI 2**, or **VGA**.

5.3 Control Menu

Tap **Tools** in the sidebar to show the control menu. The following operations are available.

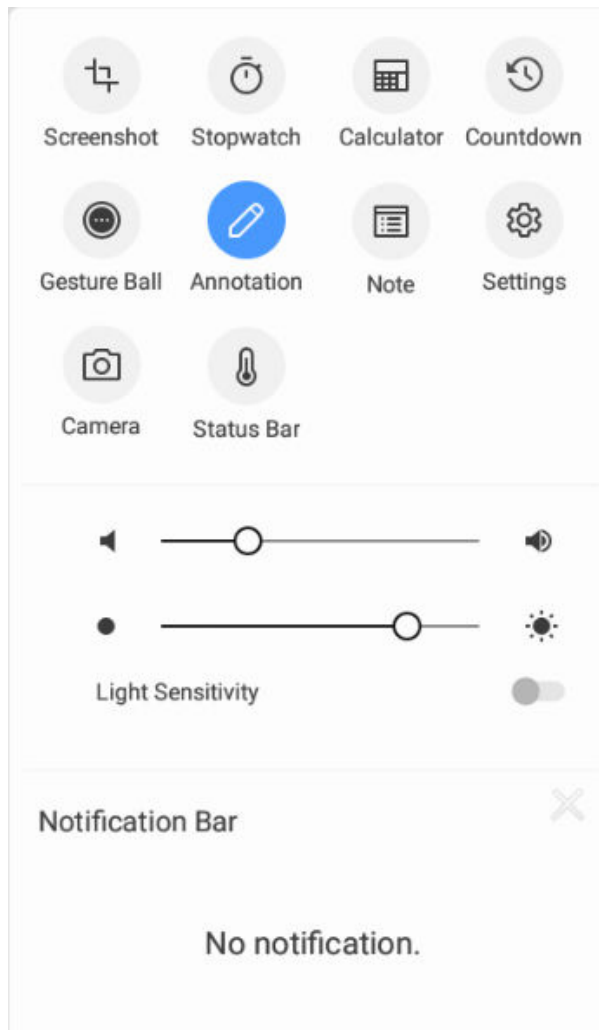







Figure 5-2 Control Menu

- Tap **Screenshot** to capture the current page.
- Tap **Stopwatch** and tap **Start** to count.
- Tap **Calculator** to calculate quickly.
- Tap **Countdown** to set countdown time and count down.
- Tap **Gesture Ball**. Operations of the gesture ball are described as follows.

Table 5-2 Gesture Ball Operations

Operation	Description	Operation	Description
Swipe up	Display all the windows.	Swipe down	Open the control menu.
Swipe left	Open the Whiteboard.	Swipe right	Enable annotating.
Long press and move	Move the gesture ball.	---	---

- Tap **Annotation** and  pops up. Tap  to enable annotating. You can add notes on the current page.
- Tap **Note** to create a note page.
- Tap **Settings** to open system settings.
- Tap **Camera** to open the camera.
- Tap **Status Bar** to show or hide the status bar indicating device temperature, CPU status, and memory status.
- Slide  progress bar to set the volume of the device.
- Slide  progress bar to set the brightness of the device.
- Check **Light Sensitivity**, and the device automatically sets the brightness.
- The **Notification Bar** stores system notifications. You can tap  to close the system notifications, except those for background processes.

5.4 Screenshot

Tap **Screenshot** in the control menu and a capture area pops up on the current page. Adjust the area by tapping and dragging the four corners. The screenshot toolbar pops up on the lower right corner of the area.

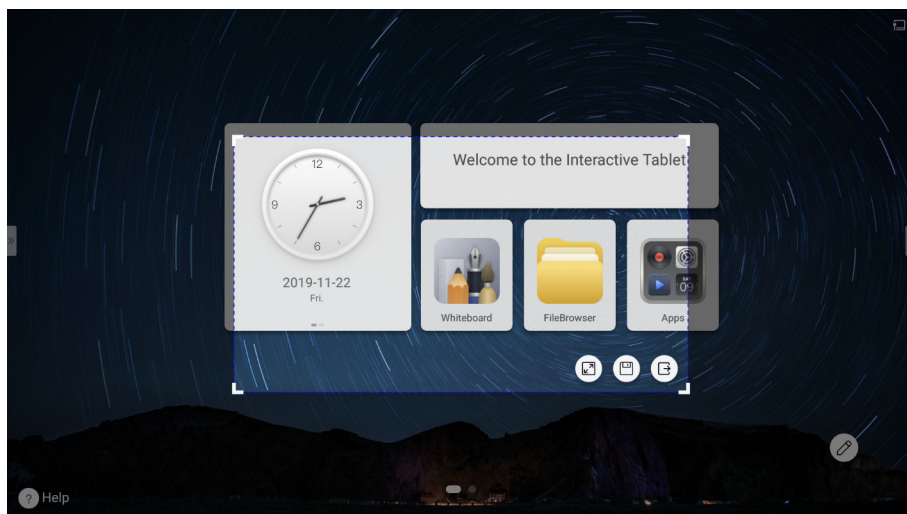





Figure 5-3 Screenshot

Table 5-3 Screenshot Toolbar Descriptions

Icon	Description
	Capture the whole page.
	Save the screenshot in the capture area.
	Exit screenshot.

5.5 Annotating

Tap  to enable annotating. You can add annotations anywhere on the page by touching and moving on the screen. The annotation bar pops up on the side of the screen.

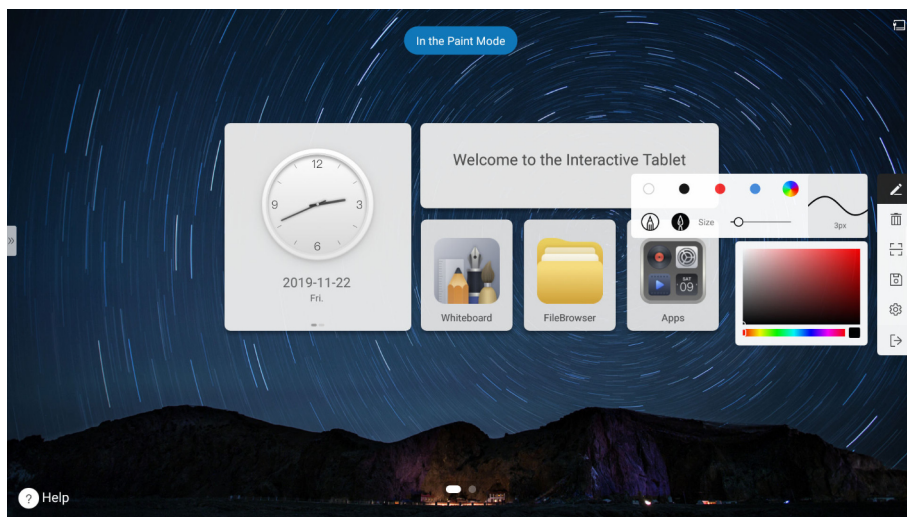











Figure 5-4 Annotating

Table 5-4 Annotation Bar Descriptions

Icon	Description
	<ul style="list-style-type: none"> • Select the pen color and hue range. • Select pen thickness. Enable angled stroke or not. Tap  to have lines with angled stroke, and tap  to have lines without angled stroke. • Slide Size bar to select line size.
	Delete the annotation.
	When the interactive tablet is connected to the Internet, you can tap  to generate the annotation into a QR code, and any devices in the LAN can scan the QR code to download the annotation.

Interactive Tablet User Manual

Icon	Description
	Save the annotation page. The annotations are saved in the default directory: <i>SD card/Pictures/Screenshots.</i>
	Scan QR code to download in LAN indicates that you can only download the annotation in LAN.
	Exit annotating.

Chapter 6 System Settings

Tap **Apps** on the main page to go to the functional interface.

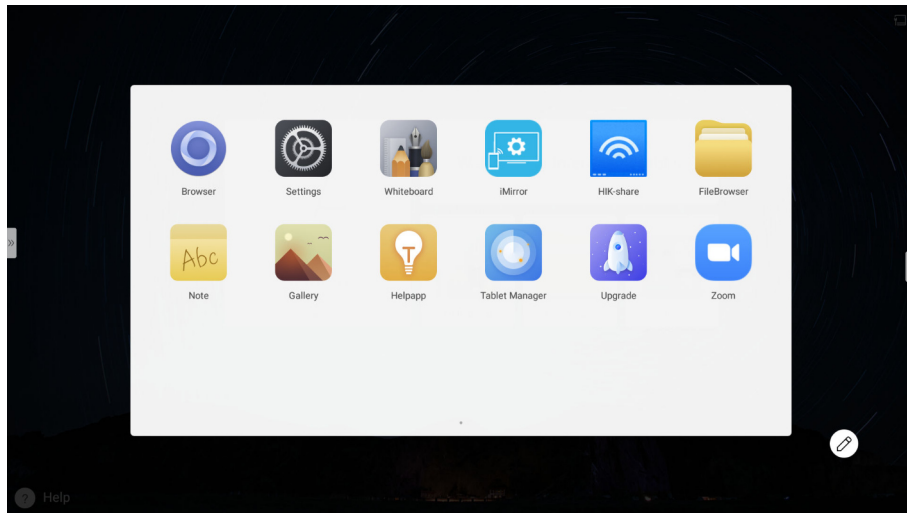

Figure 6-1 Functional Interface

6.1 Network Settings

6.1.1 Wired Network Settings

Steps

1. Select **Settings** → **Network** → **Wired Network** .
2. Check **Wired Network**.

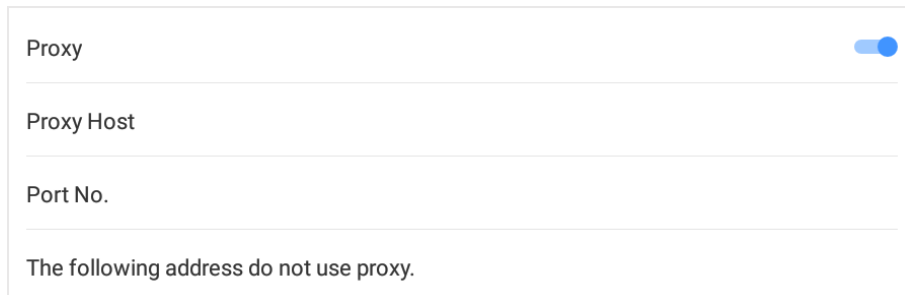

Figure 6-2 Wired Network Settings

3. **Optional:** Tap **Network Settings** to enable **Proxy** and **Static IP** or not.

Proxy Settings

When proxy enabled, you need to set **Proxy Host** and **Port No.**, and set the URLs that do not use the proxy.



The screenshot shows a settings panel for proxy configuration. At the top, there is a toggle switch labeled 'Proxy' which is turned on (blue). Below this are three input fields: 'Proxy Host', 'Port No.', and a section titled 'The following address do not use proxy.' with a text input field.

Figure 6-3 Proxy Settings

Static IP Settings

When static IP enabled, you need to set network parameters, such as **Static IP Address**, **Gateway**, **Subnet Mask**, **DNS1 Address**, and **DNS2 Address**.

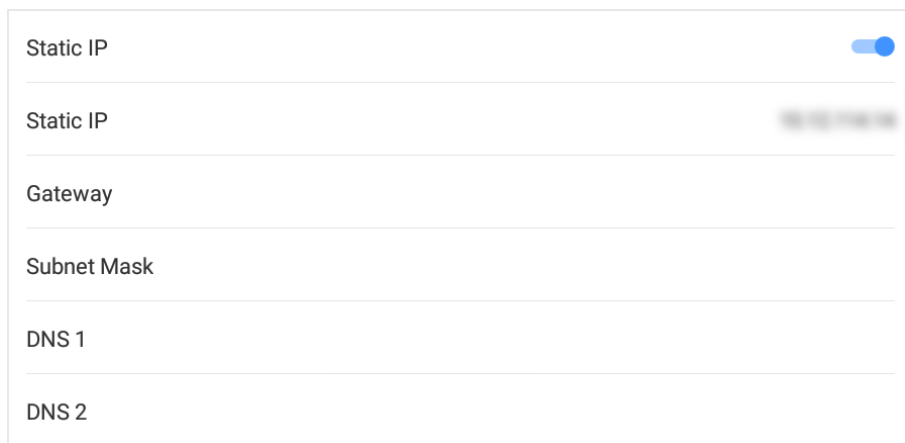

The screenshot shows a settings panel for static IP configuration. At the top, there is a toggle switch labeled 'Static IP' which is turned on (blue). Below this are six input fields: 'Static IP', 'Gateway', 'Subnet Mask', 'DNS 1', and 'DNS 2'.

Figure 6-4 Static IP Settings

6.1.2 Wireless Network Settings

Steps

1. Select **Settings** → **Network** → **Wireless Network** .
2. Check **WLAN**, and you can add other networks or connect to available networks.

Connect to Available Networks

- Tap the desired network in the available network list, and enter the password to connect to the network.
- Tap **Connect**, and network information page pops up. Tap **Clear Network** to delete the information of this network. Tap **Cancel** to exit the page.

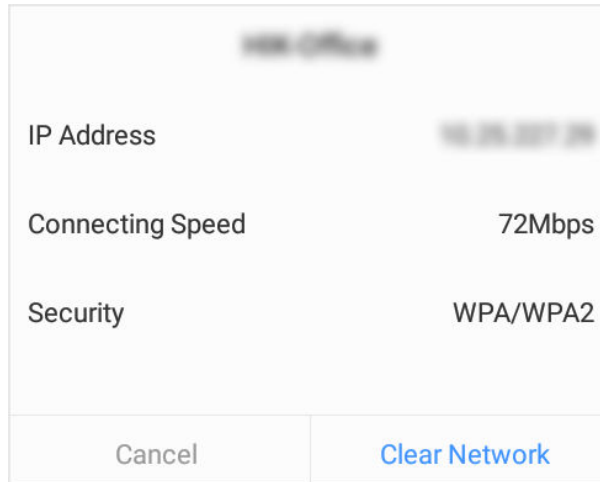

Figure 6-5 Wireless Network Information

Add Other Networks

Steps

1. Tap **Add Other Networks**.
2. Enter Wi-Fi name and select **Security**.

Add Network

Please input Wi-Fi name

Security OPEN >

Display Advanced Settings

Proxy None >

IP Settings DHCP >

Cancel Connect

Figure 6-6 Add Other Networks

3. **Optional:** Check **Display Advanced Settings** to select proxy and network IP type.
4. Tap **Connect** to connect the device to the added wireless network.

6.1.3 WLAN Hotspot Settings

When the interactive tablet is connected to the wired network, it can provide wireless network for other devices with WLAN hotspot enabled.

Steps

1. Select **Settings** → **Network** → **Hotspot** .
2. Check **Portable WLAN Hotspot**.
3. Tap **Set WLAN Hotspot**, and set parameters in the pop-up page.

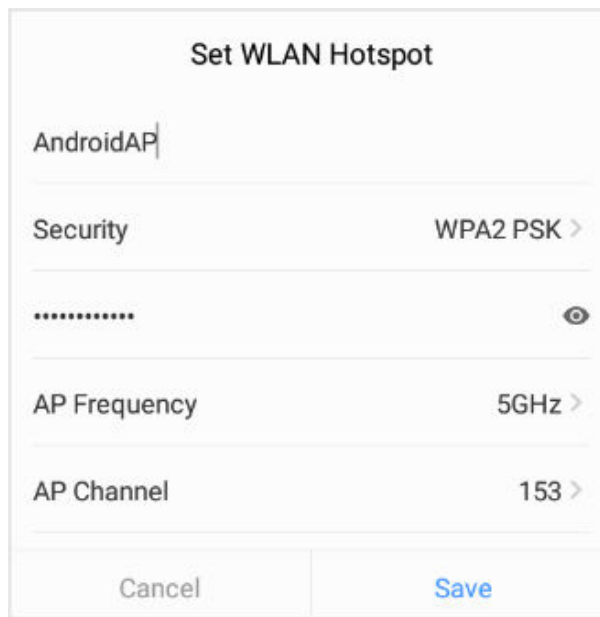

Figure 6-7 Set WLAN Hotspot

4. Tap **Save** to set WLAN hotspot.

 **Note**

If the device supports 2.4 GHz and 5 GHz at the same time, it is recommended to set AP band to 5 GHz to better experience functions such as wireless screen mirroring.

6.2 Display Settings

Select **Settings** → **Display** to adjust parameters, such as brightness and sleeping time.

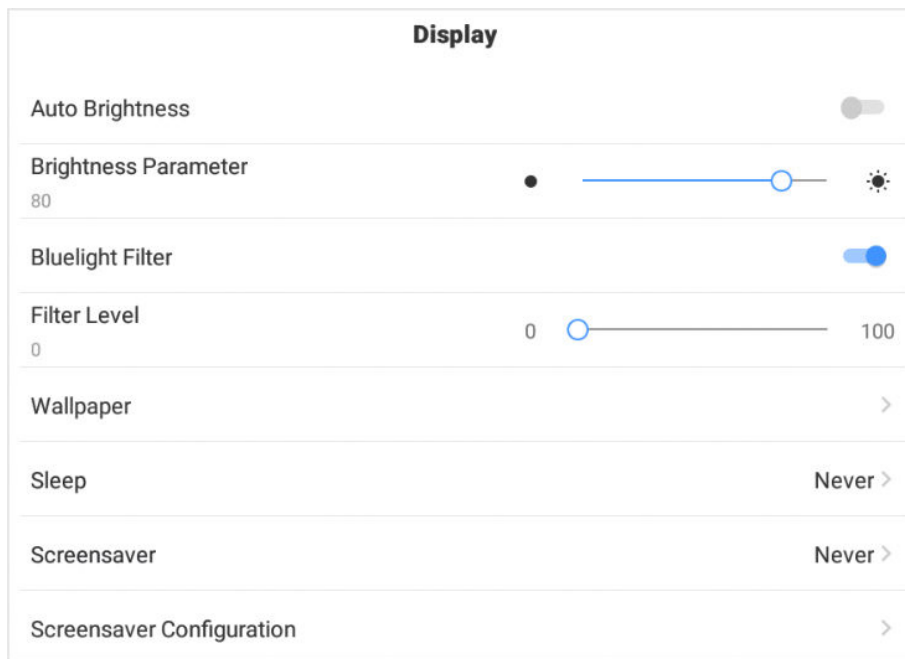

Figure 6-8 Display Settings

- **Auto Brightness:** The device can adjust brightness according to the environment automatically when enabled.
- **Brightness Parameter:** Slide the slider to adjust the brightness of the screen.
- **Bluelight Filter:** Tap **Bluelight Filter** to protect your eyes by filtering blue light.
- **Filter Level:** Slide the bar to adjust the filter level.
- **Wallpaper:** Tap **Wallpaper** to set dynamic wallpapers or pictures in the system as wallpaper.
- **Sleep:** The system goes to sleep status after a specified period of inactivity.
- **Screensaver:** Screensaver will be enabled after a specified period of inactivity.
- **Screensaver Configuration:** Tap **Screensaver Configuration**, select a screensaver picture in the pop-up page, and tap **Apply** to enable new screensaver.

 **Note**

You can add new screensaver pictures in **Screensaver Configuration** by tapping + .

6.3 Audio Settings

Steps

1. Select **Settings** → **Audio** .

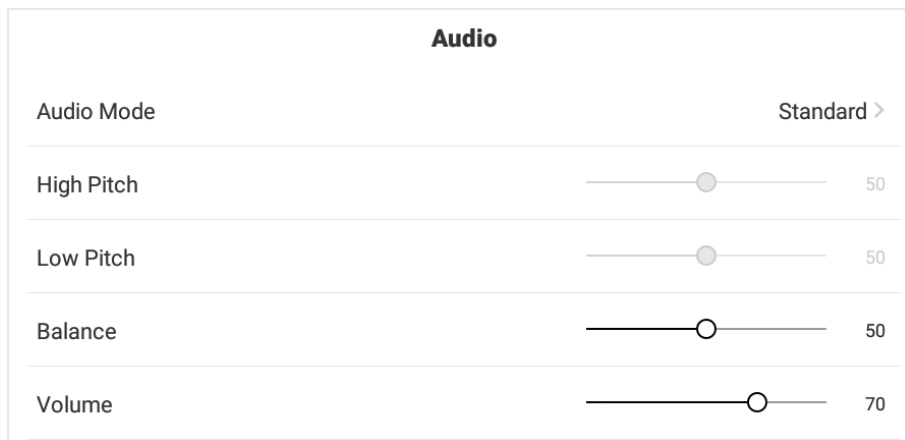

Figure 6-9 Audio Settings

2. Tap **Audio Mode**, and select a mode from **Standard**, **Music**, **Movie**, and **User**.
3. Set the parameters according to the audio mode.
 - In **Standard**, **Music**, and **Movie** mode, you can adjust **Balance** and **Volume**.
 - In **User** mode, you can adjust **High Pitch**, **Low Pitch**, **Balance** and **Volume**.

6.4 Language & Input Settings

Steps

1. Select **Settings** → **Language & Input** .
2. Tap **Language** to select multilanguage.
3. Tap **Input Method** to set multilingual input method.

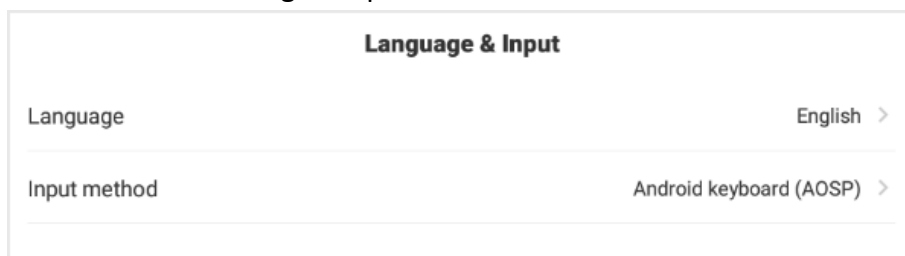

Figure 6-10 Language & Input Settings

6.5 Time & Date Settings

Steps

1. Select **Settings** → **Time & Date** .

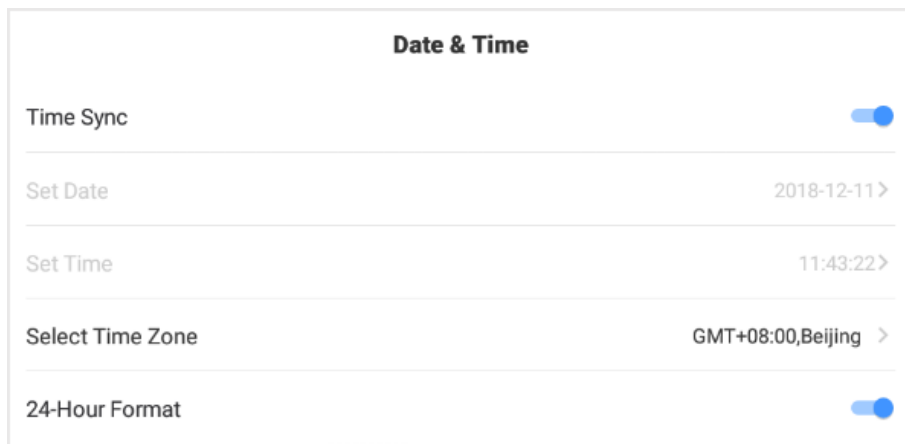

Figure 6-11 Time & Date Settings

2. Check **Time Sync**.
3. Tap **Select Time Zone** to select the region where you are.
4. **Optional:** Check **24-Hour Format** to set 24-hour format.

 **Note**

When **Time Sync** is closed, you can set date and time manually.

6.6 Application Management

Steps

1. Check **Settings** → **Application Management** .
2. Tap the desired APP, and **Application Details** pops up.
3. You can perform operations, such as **Forced Stop**, **Clear Data**, **Clear Cache**, and **Uninstall**.

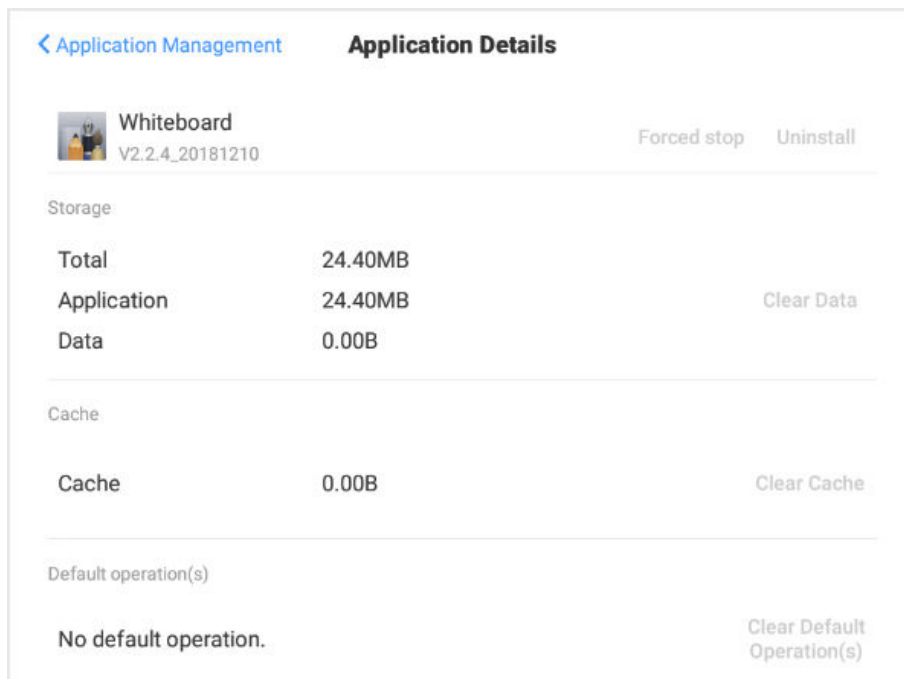

Figure 6-12 Application Details

 **Note**

- The built-in APP cannot be uninstalled.
 - You can tap the icon in **Application Details** to open the APP.
-

6.7 Intelligent Temperature Control

The device monitors inner temperature in real time. When the temperature exceeds the set warning or alarming temperature, the device will display prompt messages for you to take measures in a timely manner.

Steps

1. Select **Settings** → **Auxiliary Functions** → **Intelligent Temperature Control** .

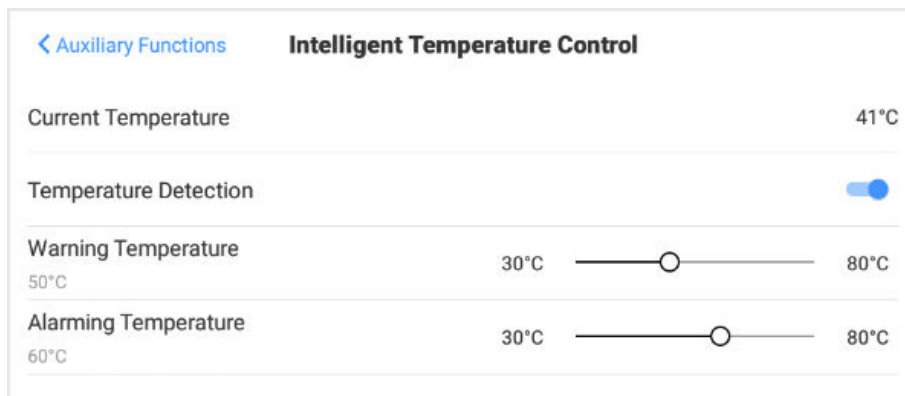

Figure 6-13 Intelligent Temperature Control

2. Check **Intelligent Temperature Control**.

3. Slide the slider to set **Warning Temperature** and **Alarming Temperature**.

- When the temperature exceeds the set warning temperature, the temperature in status bar on the upper right corner turns red.
- When the temperature exceeds the set alarming temperature, the temperature information pops up and prompts you to turn off the device.

6.8 Advanced Settings

Select **Settings** → **Advanced Settings** . You can set parameters as follows.

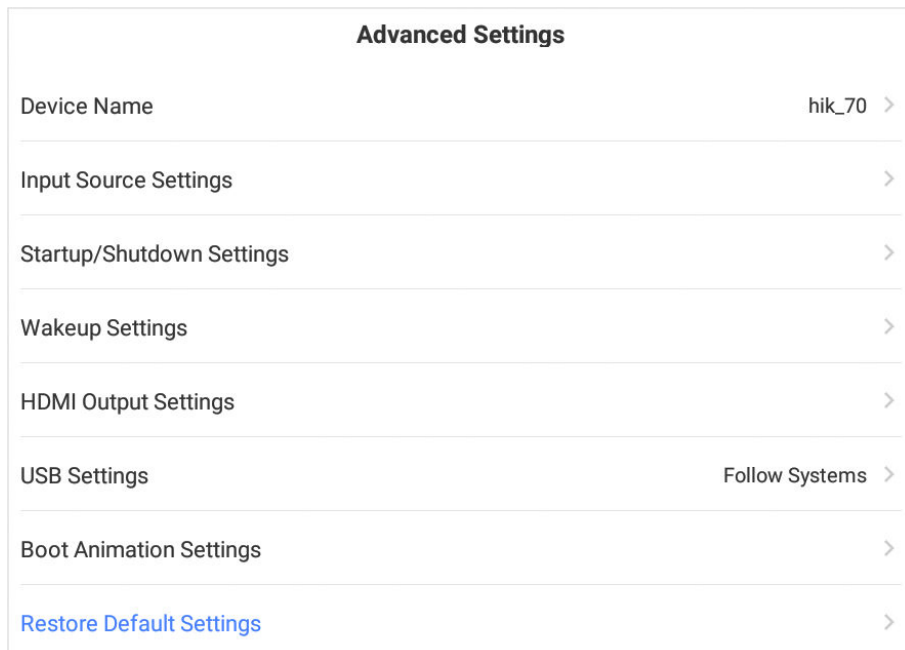

Figure 6-14 Advanced Settings

- **Device Name:** View the device name, and rename the device by tapping **Device Name**.
- **Input Source Settings:** Tap **Input Source Settings** to set the **Startup Input Source** and auto channel switch.
- **Startup/Shutdown Settings:** Set **Startup Mode**, **Scheduled Startup/Shutdown**, and **No-signal Shutdown**.
- **Wakeup Settings:** Set **Wake from Serial Port**, and **Wake from Signal Source**.
- **HDMI Output Settings:** Connect the monitor by HDMI interface to share the contents on the interactive tablet interface. Tap **Output Resolution Settings** to set resolution.

 **Note**

The monitor connected to the interactive tablet need to support HDCP.

- **USB Settings:** **Follow Systems**, **Android** and **PC** modes are available.
- **Boot Animation Settings:** Set the boot animation when startup the tablet.
- **Restore Factory Defaults:** Once the device is restored to factory defaults, all the configuration data is lost.

 **Warning**

Be cautious to restore factory defaults.

6.8.1 Input Source Settings

Select **Advanced Settings** → **Input Source Settings** .

- Tap **Startup Input Source** to set the startup channel **Android** by default.
- Check **Auto Switch When Connecting Signal Source**, and the device detects and switches to the signal channels automatically, when HDMI or VGA signals are input in working status.
- Tap **Auto Switch When Disconnecting Signal Source**, and the device switches to the set channel if the current signal is disconnected in working status.

6.8.2 Startup/Shutdown Settings

Select **Advanced Settings** → **Startup/Shutdown Settings** .

- **Startup Mode:** **Standby When Powered on** and **Startup When Powered on** are available to select.
- **Scheduled Startup/Shutdown:** Set everyday startup and shutdown time.
- **No-signal Shutdown:** The device will shut down without signal input in a period of time.

6.8.3 Wakeup Settings

Select **Advanced Settings** → **Wakeup Settings** .

- **Wake from Serial Port:** Enable or disable the serial port channel.
- **Wake from Signal Source:** Enable or disable the signal source channel.

6.8.4 HDMI Output Settings

Select **Advanced Settings** → **HDMI Output Settings** .

- **Output Resolution Settings:** 3840 × 2160, 1920 × 1080, and 720 × 480 are available.
- **Audio Settings:** Check **Audio Settings** to play audio.
- **HDCP:** The monitor connected to the interactive tablet need to support HDCP.

6.8.5 USB Settings

The devices inserted into the USB interface can change the mode according to your choice.

- **Follow Systems:** The system of the device inserted into the USB interface is consistent with the tablet system.
- **Android:** The system of the device inserted into the USB interface is Android system.
- **PC:** The system of the device inserted into the USB interface is PC system.

6.9 Device Information

Select **Settings** → **About** to check the device information.

Chapter 7 Intelligent Applications

7.1 FileBrowser

Tap **FileBrowser** on the main page. All the files under the current directory are shown by default. Tap **Image**, **Doc**, and **AV**, to sort and view specified files.

Icons are described as follows.

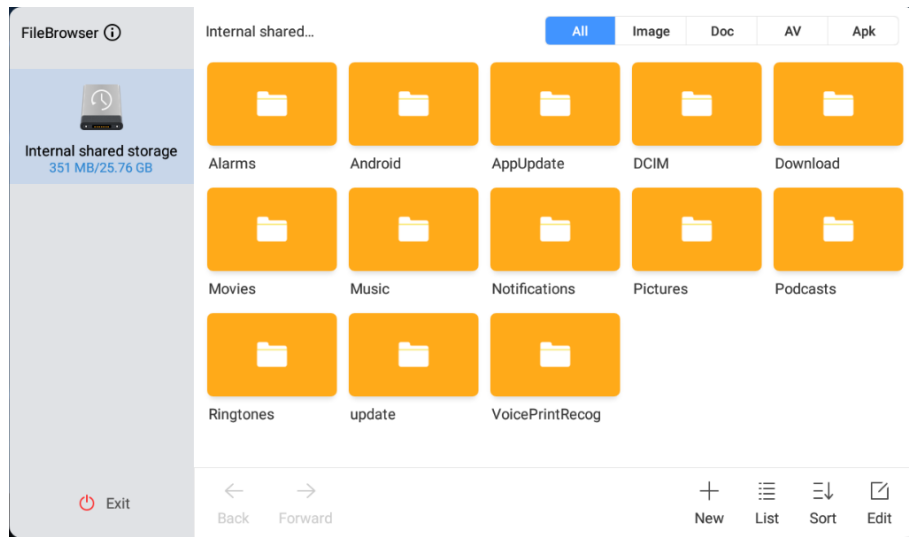

Figure 7-1 FileBrowser

Table 7-1 Descriptions of File Management Icons

Icon	Description	Icon	Description
Back/Forward	Go to the previous/ next page.	New	Create a folder.
List	File view mode, including view in list and view by icon.	Sort	Change the file order.
Edit	Edit the files.	---	---

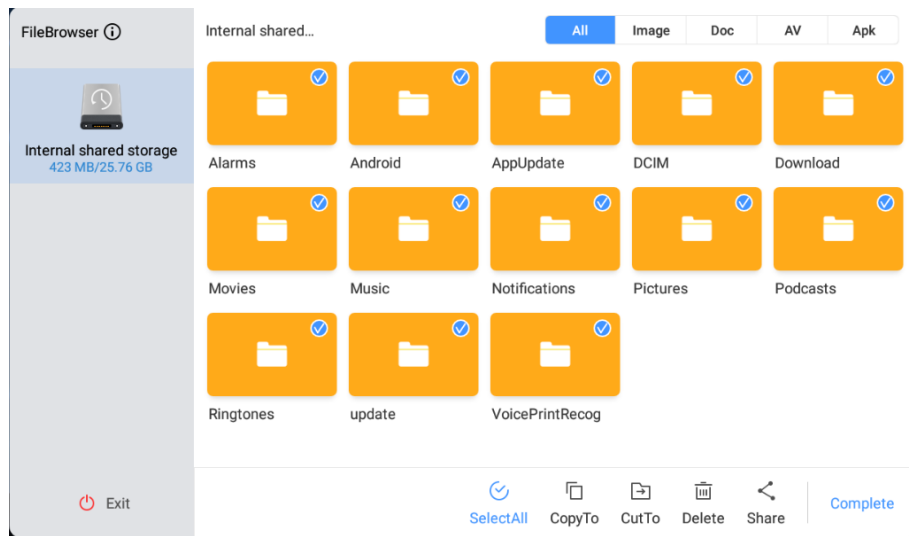

Figure 7-2 Edit the Files

Table 7-2 Descriptions of Editing Icons

Icon	Description	Icon	Description
Select All	Select all the files.	Copy To	Copy the selected file.
Cut To	Move the selected file.	Delete	Delete the selected file.
Share	Share the selected file.	— —	— —

Note

Long press the file to copy, move, delete, share, rename, and view information.

7.2 Browser

Connect the device to the Internet, and tap **Browser**. Enter URL in the address bar to view texts, pictures, audio and videos on the Internet.

7.3 System Preinstalled Applications

The following table briefly describes the applications preinstalled in the system. Refer to the help document of desired application, to get more details.

Table 7-3 Introduction of System Preset Applications

Application	Introduction
Whiteboard	Whiteboard is used for drawing and writing. You can use it to save, move, zoom in, zoom out, delete, and download the contents.
Note	Note is used for recording brief information. You can swipe up from the bottom of the screen to use Note.
User Manual	You can use the User Manual to do basic operations.
Upgrade	System Upgrade supports remote upgrade, local upgrade and local mcu upgrade.
Gallery	You can view pictures in SD card and USB disk.
Control Menu	You can view basic system functions and toolkit.
Zoom	Zoom is an online video conferencing system, which features in real-time messaging and content sharing.

Appendix A. FAQs

Question	Cause and Solution
<p>Why do the condensations appear frequently on the screen?</p>	<p>Tempered glass is installed on the outer screen to provide protection. There is a gap between the screen and the tempered glass for air convection. The main reason is that there is a temperature difference between the screen and the outside. Hot air condenses on the glass surface at a lower temperature, which results in condensations.</p> <p>Condensations will evaporate after the device starts up and will not affect the use of the device.</p>
<p>Why there is no sound coming from my laptop after connection?</p>	<p>If the device is accessed via the VGA interface, only image output is available. If only audio cable is accessed, both audio output and image output will be unavailable.</p> <ul style="list-style-type: none"> • Access both audio cable and VGA cable for image and audio output. • Access HDMI cable. • Select the device as the audio output device in Windows.
<p>Why does the screen get hot after a period of use?</p>	<p>Screen temperature rise is caused by heat dissipation and is completely normal. Our heat dissipation design is industrial-leading and is the formulator of the industry standards, which is in accordance with the national health standard.</p>
<p>Does long-time use damage the eyes?</p>	<p>The recognition of flicker by human eyes is 50Hz. If the frequency is lower than 50Hz, then the flicker will be recognized and cause eye muscles fatigue. We use 60Hz LCD screen, human eyes will not recognize the flicker of the screen. Compared with other products of the same kind, it can reduce eye fatigue to a large extent.</p>
<p>Why there is no image in screen nor sound coming from the device?</p>	<ul style="list-style-type: none"> • Check if the power cable is connected. • Check if the socket works normally. • Check if the power switch is turned on.
<p>Why doesn't the image perfectly match the screen after accessing PC via VGA?</p>	<ul style="list-style-type: none"> • Apply auto-adjust function in VGA channel. • Apply auto-adjust function in the control menu. • Change VGA terminal or cable.

Question	Cause and Solution
Why does the device HDMI channel have no input signal?	<ul style="list-style-type: none">• Check if the input source works normally.• Change HDMI interface or cable.• If PC is accessed, set HDMI output on your PC.
How to deal with image ghosting?	<ul style="list-style-type: none">• Check if the VGA cable is loose.• Try to change VGA cable or change to another VGA interface.
How to deal with image color abnormality after accessing PC via VGA channel?	<ul style="list-style-type: none">• Check if the VGA cable is loose.• Check if the pins of the two terminals of the VGA cable are damaged.• Change VGA cable if it's damaged.
Why does the VGA interface of the accessed PC have no output signal?	<ul style="list-style-type: none">• Check video card settings in your PC control panel, try to change the output mode.• Change VGA cable if it's damaged.
Why is wired network unstable?	Try to disable the auto network detection option.



See Far, Go Further