

©2022 Hangzhou Hikvision Digital Technology Co., Ltd. All rights reserved.

About this Manual

The Manual includes instructions for using and managing the Product. Pictures, charts, images and all other information hereinafter are for description and explanation only. The information contained in the Manual is subject to change, without notice, due to firmware updates or other reasons. Please find the latest version of this Manual at the Hikvision website (<https://www.hikvision.com/>). Please use this Manual with the guidance and assistance of professionals trained in supporting the Product.

HIKVISION and other Hikvision's trademarks and logos are the properties of Hikvision in various jurisdictions. Other trademarks and logos mentioned are the properties of their respective owners.

Disclaimer
 TO THE MAXIMUM EXTENT PERMITTED BY APPLICABLE LAW, THIS MANUAL AND THE PRODUCT DESCRIBED, WITH ITS HARDWARE, SOFTWARE AND FIRMWARE, ARE PROVIDED "AS IS" AND "WITH ALL FAULTS AND ERRORS". HIKVISION MAKES NO WARRANTIES, EXPRESS OR IMPLIED, INCLUDING WITHOUT LIMITATION, MERCHANTABILITY, SATISFACTORY QUALITY, OR FITNESS FOR A PARTICULAR PURPOSE. THE USE OF THE PRODUCT BY YOU IS AT YOUR OWN RISK. IN NO EVENT WILL HIKVISION BE LIABLE TO YOU FOR ANY SPECIAL, CONSEQUENTIAL, INCIDENTAL, OR INDIRECT DAMAGES, INCLUDING, AMONG OTHERS, DAMAGES FOR LOSS OF BUSINESS PROFITS, BUSINESS INTERRUPTION, OR LOSS OF DATA, CORRUPTION OF SYSTEMS, OR LOSS OF DOCUMENTATION, WHETHER BASED ON BREACH OF CONTRACT, TORT (INCLUDING NEGLIGENCE), PRODUCT LIABILITY, OR OTHERWISE, IN CONNECTION WITH THE USE OF THE PRODUCT, EVEN IF HIKVISION HAS BEEN ADVISED OF THE POSSIBILITY OF SUCH DAMAGES OR LOSS.
 YOU ACKNOWLEDGE THAT THE NATURE OF INTERNET PROVIDES FOR INHERENT SECURITY RISKS, AND HIKVISION SHALL NOT TAKE ANY RESPONSIBILITIES FOR ABNORMAL OPERATION, PRIVACY LEAKAGE OR OTHER DAMAGES RESULTING FROM CYBER-ATTACK, HACKER ATTACK, VIRUS INSPECTION, OR OTHER INTERNET SECURITY RISKS; HOWEVER, HIKVISION WILL PROVIDE TIMELY TECHNICAL SUPPORT IF REQUIRED.
 YOU AGREE TO USE THIS PRODUCT IN COMPLIANCE WITH ALL APPLICABLE LAWS, AND YOU ARE SOLELY RESPONSIBLE FOR ENSURING THAT YOUR USE CONFORMS TO THE APPLICABLE LAW. ESPECIALLY, YOU ARE RESPONSIBLE, FOR USING THIS PRODUCT IN A MANNER THAT DOES NOT INFRINGE ON THE RIGHTS OF THIRD PARTIES, INCLUDING WITHOUT LIMITATION, RIGHTS OF PUBLICITY, INTELLECTUAL PROPERTY RIGHTS, OR DATA PROTECTION AND OTHER PRIVACY RIGHTS. YOU SHALL NOT USE THIS PRODUCT FOR ANY PROHIBITED END-USES, INCLUDING THE DEVELOPMENT OR PRODUCTION OF WEAPONS OF MASS DESTRUCTION, THE DEVELOPMENT OR PRODUCTION OF CHEMICAL OR BIOLOGICAL WEAPONS, ANY ACTIVITIES IN THE CONTEXT RELATED TO ANY NUCLEAR EXPLOSIVE OR UNSAFE NUCLEAR FUEL-CYCLE, OR IN SUPPORT OF HUMAN RIGHTS ABUSES.
 IN THE EVENT OF ANY CONFLICTS BETWEEN THIS MANUAL AND THE APPLICABLE LAW, THE LATER PREVAILS.



This product and - if applicable - the supplied accessories too are marked with "CE" and comply therefore with the applicable harmonized European standards listed under the EMC Directive 2014/30/EU, RE Directive 2014/53/EU, the RoHS Directive 2011/65/EU.



Ensure correct wiring of the terminals for connection to an AC mains supply.



2012/19/EU (WEEE directive): Products marked with this symbol cannot be disposed of as unsorted municipal waste in the European Union. For proper recycling, return this product to your local supplier upon the purchase of equivalent new equipment, or dispose of it at designated collection points. For more information see: www.recyclethis.info



2006/66/EC (battery directive): This product contains a battery that cannot be disposed of as unsorted municipal waste in the European Union. See the product documentation for specific battery information. The battery is marked with this symbol, which may include lettering to indicate cadmium (Cd), lead (Pb), or mercury (Hg). For proper recycling, return the battery to your supplier or to a designated collection point. For more information see: www.recyclethis.info



Caution

1. Install the equipment according to the instructions in this manual.
2. This equipment is not suitable for use in locations where children are likely to be present.
3. This equipment is suitable for use in gang box or other enclosure protected device only.
4. To prevent injury, this equipment must be securely attached to the floor/wall in accordance with the installation instructions.
5. No naked flame sources, such as lighted candles, should be placed on the equipment.
6. The equipment has been designed, when required, modified for connection to an IT power distribution system.
7. A readily accessible disconnect device shall be incorporated external to the equipment.
8. The socket-outlet shall be installed near the equipment and shall be easily accessible.
9. Burned fingers when handling the device. Wait one-half hour after switching off before handling the parts.
10. Use only power supplies at the standard of 100 VAC to 240 VAC, 50/60 HZ.
11. The equipment shall not be exposed to dripping or splashing and that no objects filled with liquids, such as vases, shall be placed on the equipment.

1 Appearance

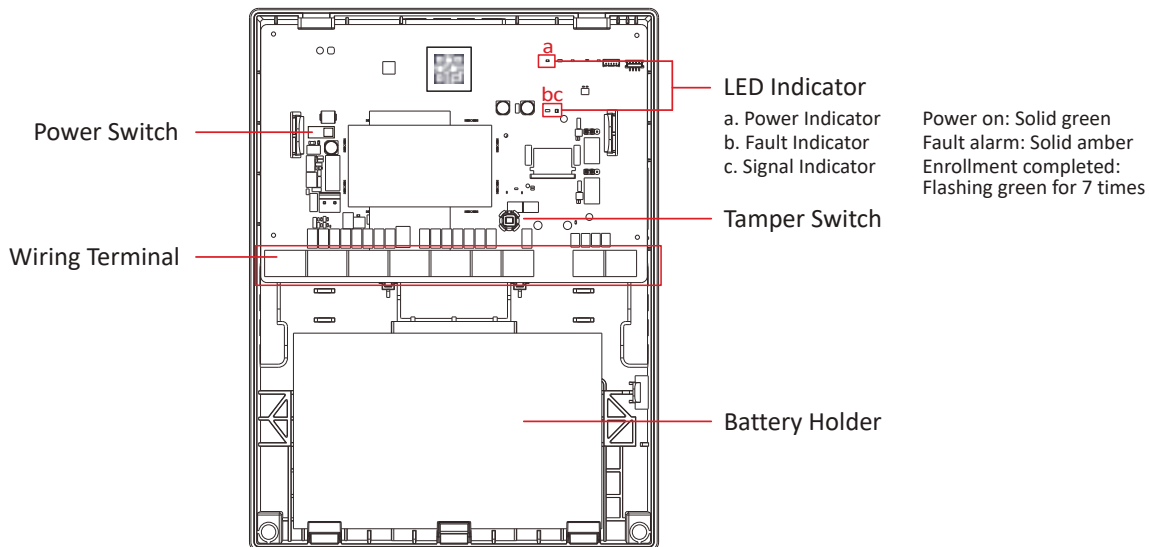

2 Set Up

1. Loosen the screw and open the shell.
2. Pull the plastic buckle outward and get the board.
3. Set wiring.

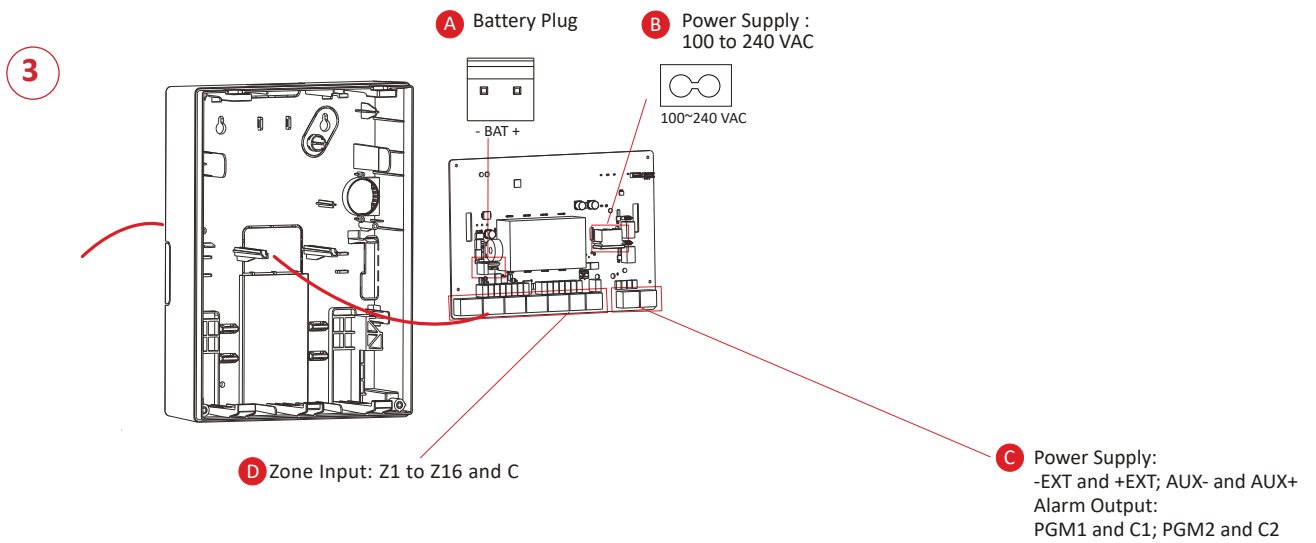
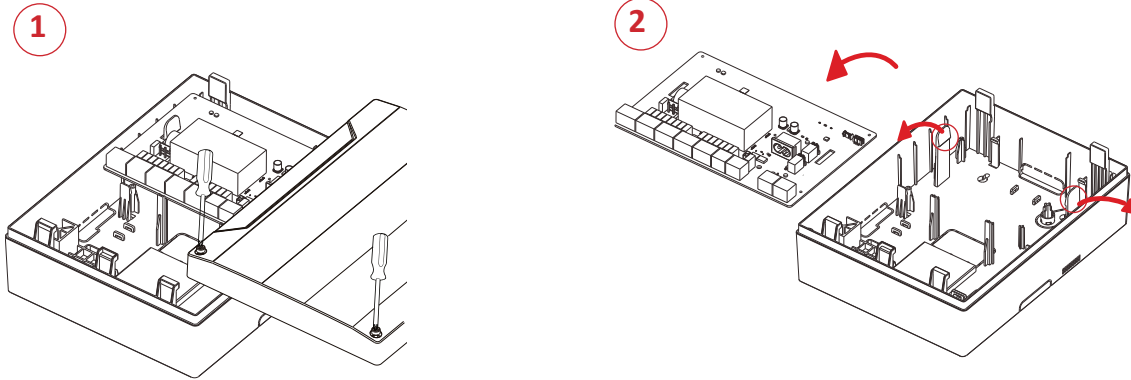

Z1	C	Z2	Z3	C	Z4	Z5	C	Z6	Z7	C	Z8	AUX- AUX+	Z9	C	Z10	Z11	C	Z12	Z13	C	Z14	Z15	C	Z16
----	---	----	----	---	----	----	---	----	----	---	----	-----------	----	---	-----	-----	---	-----	-----	---	-----	-----	---	-----

-EXT	+EXT	PGM1	C1	PGM2	C2
------	------	------	----	------	----

D1 EOL (NC Detector)

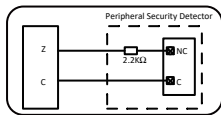

D2 EOL (NO Detector)

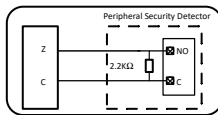

D3 DEOL (NC) and DEOL(NO)

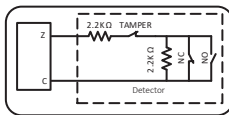

D4 Dual-Zone Series Connection

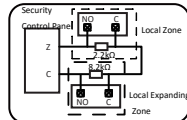

D5 Normally Closed

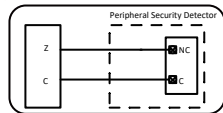

D6 Normally Open

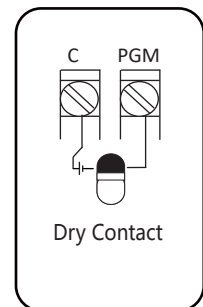
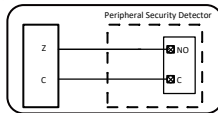

4. Install the board back.

Fix the transmitter to the wall with screws.

5. Enrollment

• Enrollment Preparation

Log in to the APP Store, download and install the App.

Power on the security control panel.

Log in the APP and tap the icon "+". Scan the QR code or input the control panel serial No. to add the control panel.

① Enroll the Peripheral Locally

In the APP, tap the "Enrollment Mode" button on the control panel page to make the control panel enter the enrollment status.

② Enroll the Peripheral with QR and serial No.

In the APP, tap the icon "+" and scan the QR code or serial No. on the peripheral.

6. Power on the transmitter.

Enrollment completed: Flashing green for 7 times.

7. Install the shell back.

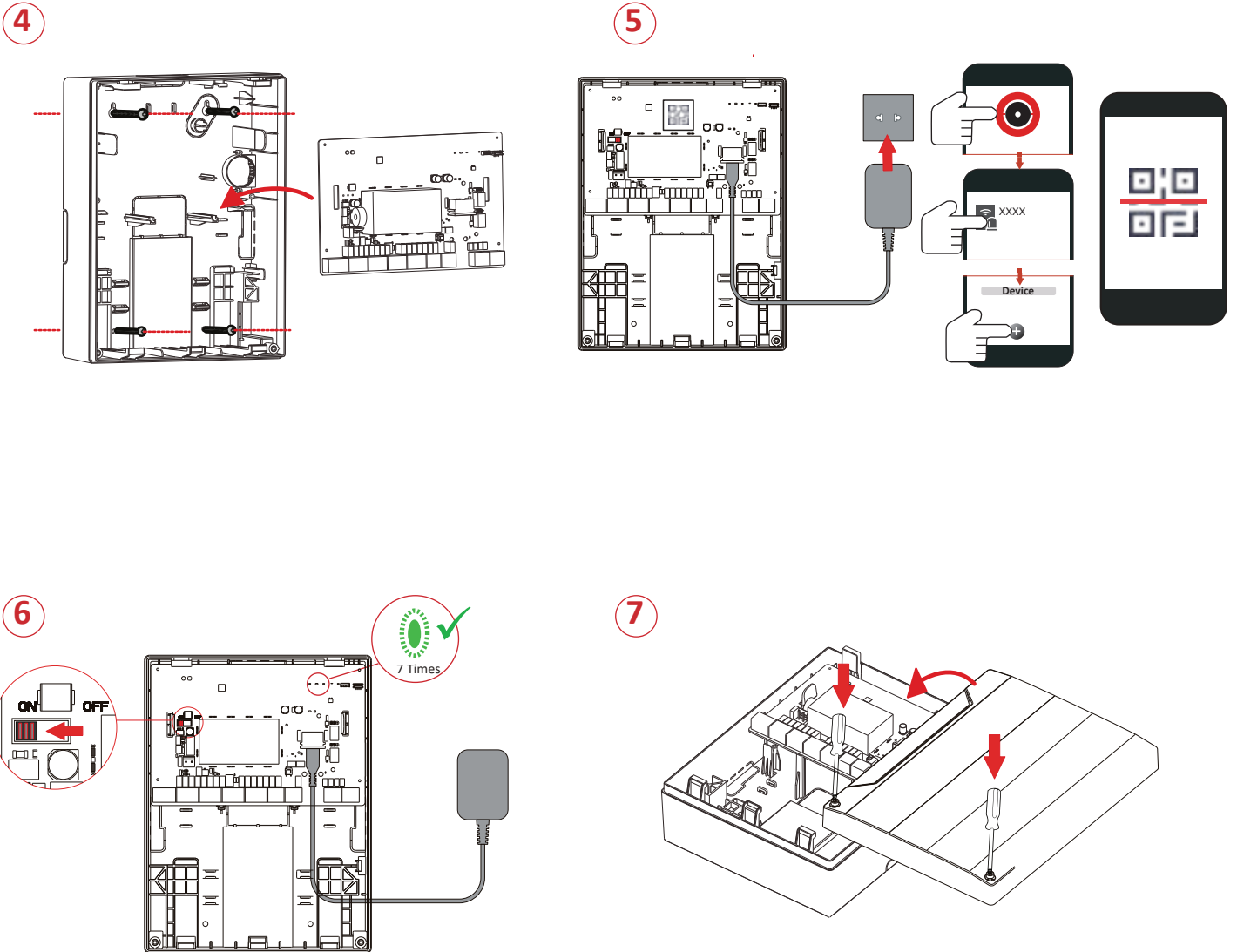

3 Set Up with App

You can view the device status including temperature, signal intensity, battery level, lid, external input, etc., on the device page. Tap the  button to enter the settings page.

4 Operation Caution and Device Maintenance

- All the electronic operation should be strictly compliance with the electrical safety regulations, fire prevention regulations and other related regulations in your local region.
- Do not drop the device or subject it to physical shock, and do not expose it to high electromagnetism radiation. Avoid the equipment installation on vibrations surface or places subject to shock (ignorance can cause equipment damage).
- Please make sure that the power has been disconnected before you wire, install or dismantle the device.
- If smoke, odors or noise rise from the device, turn off the power at once and unplug the power cable, and then please contact the service center.
- Do not drop the device or subject it to physical shock, and do not expose it to high electromagnetism radiation. Avoid the equipment installation on vibrations surface or places subject to shock (ignorance can cause equipment damage).
- Do not place the device in extremely hot (refer to the specification of the device for the detailed operation temperature), cold, dusty or damp locations, and do not expose it to high electromagnetic radiation.
- The device for indoor use shall be kept from rain and moisture.
- Exposing the equipment to direct sun light, low ventilation or heat source such as heater or radiator is forbidden (ignorance can cause fire danger).
- Do not aim the device at the sun or extra bright places. A blooming or smear may occur otherwise (which is not a malfunction however), and affecting the endurance of sensor at the same time.
- Improper use or replacement of the battery may result in hazard of explosion. Replace with the same or equivalent type only. Dispose of used batteries according to the instructions provided by the battery manufacturer.
- Do not expose the device to the corrosive gas. Otherwise the equipment damage may occur.
- Do not expose the device to the explosive situation.

5 Specification

RF Frequency	868/433 MHz
Modulation	2GFSK
Method	Two-way communication
RF Distance	800 m (open area)
Zone Input	16
EOL	1K, 2.2K, 4.7K, 8.2K
Tamper Switch	2 (Front and Rear)
Relay Output	2
12 V Input	1, Connects to the Battery
12 V Output	2-channel Total Consumption: 1 A
Power Switch	1
Series Port	1
LED Status	3: Alarm/Tamper (Red), Fault (Amber), Signal Strength (Green/Red)
Power Supply	100 to 240 VAC
Operation temperature	-10 °C to 40 °C
Operation humidity	10% to 90%
Dimension (W × H × D)	199 × 261 × 86.4 mm
Weight	975 g (without battery)