



APPROVAL SHEET

ROHS compliant

= APPROVAL SIGNATURES: =
=
=
=
=

CUSTOMER : 杭州海康威视科技有限公司

PART NO. : 101700162

ART NAME : 12V 2A ADAPTER inline S536

MODEL NO. : ASW0081-1220002W

ISSUE DATE : 2018-12-26

VERSION NO. : REV1.8

EFFICIENCY STANDARDS: ERP VI

LINKPOWER ELECTRONICS CO.,LTD.

Add.:No.656, Tongde Road, Tongxiang, Zhejiang, China P.C.:314500

Tel: +86-573-89817002

Fax: +86-573-89817000

E-mail: amberwang@acepower.com.cn

<http://www.acepower.com.cn>

Please fax back after your confirming.

 Linkpower Electronics Co., Ltd.		Approved by	Checked by	Designed by	Prepared by
Specification		Department		R&D	
Type	ASW0081-1220002W ADAPTER	Page		2	
		Date		2016-04-21	

LIST

1. Scope
2. Reference Standards
3. Environmental Conditions
4. Input Requirements
5. Output Requirements
6. Protection Requirements
7. Safety
8. Durability
9. Surge test
10. Reliability
11. Caution
12. Mechanical Performance
13. Attachment
14. Package drawing

 Linkpower Electronics Co., Ltd.		Approved by	Checked by	Designed by	Prepared by
Specification		Department		R&D	
Type	ASW0081-1220002W ADAPTER	Page		3	
		Date		2016-04-21	

1. Scope

This document details the electrical, mechanical and environmental specifications of a 100VAC-240VAC input, one output voltage **12V 2A** switching power supply.

2. Reference Standards

2.1 EMI standard

The adapter meets the radiated and conducted emission requirements for **EN 55022,FCC part 15 Class B.**

2.2 EMS standard

The adapter meets the **EN55024.**

2.3 SAFETY standard

The adapter meets **GB4943-2001,GB9254-2008,GB17625.1-2003, EN60950-1 and UL60950-1.**

3. Environmental Conditions

3.1 Operating

The adapter shall be capable of operating continuously in any mode without performance deterioration in the following environmental conditions:

3.1.1 Operating temperature: 0°C ~40°C

3.1.2 Relative Humidity: 20%~95%

3.1.3 Air Pressure: 70~106Kpa

3.2 Storage

The adapter shall be capable of standing the following environmental conditions extended periods of time, without sustaining electrical or mechanical damage and subsequent operational deficiencies:

3.2.1 Ambient Temperature: 0°C ~40°C

3.2.2 Relative Humidity: 10%~95%



Linkpower Electronics Co., Ltd.

Approved by	Checked by	Designed by	Prepared by

Specification		Department	R&D
Type	ASW0081-1220002W ADAPTER	Page	4
		Date	2016-04-21

4. Input Requirements

4.1	Rated input voltage	100VAC-240VAC
4.2	Input voltage	90VAC-264VAC
4.3	Frequency	50Hz-60Hz
4.4	Input current	1.6A, at 100VAC input, at rated load.
4.5	Input power Consumption	≤0.1W, No load

5. Output Requirements

5.1	Output voltage	12VDC
5.2	Output current	0A<I _O <2A
5.3	Voltage range	11.4VDC-12.6VDC
5.4	Ripple & Noise	≤150mV _{p-p}
5.5	Average efficiency	≥86.2%, Measurement is done by 25%load,50%load,75%load, 100%load.

Remark: Ripple & Noise measurement is done by 20MHz bandwidth oscilloscope and terminated each output with a 10uF capacitor and a 0.1uF capacitor at 220VAC input at rated load.

 Linkpower Electronics Co., Ltd.		Approved by	Checked by	Designed by	Prepared by
Specification		Department		R&D	
Type	ASW0081-1220002W ADAPTER	Page		5	
		Date		2016-04-21	

6. Protection Requirements

6.1 Short circuit protection

If short circuit occurs, all the output should be protected. The adapter shall be self-recovering when fault condition remove.

7. Safety

7.1 Dielectric strength

Primary to secondary: AC 3000Vrms,50Hz, 5mA, 1 minute for type test;
AC 3600Vrms,50Hz, 5mA,3 second for production test.

7.2 Insulation resistance

Measurements shall be made application of $20M\Omega_{\min}$ and DC500V potential across primary and secondary and across secondary and case for 1minute.

8. Durability

8.1 MTBF

The adapter shall have a calculated MTBF of greater than 50,000 hours, at ambient temperature 25°C and 230VAC input.

8.2 Burn-In

The adapter will be performed a minimum for 4 hours Burn-In at $25\pm 5^{\circ}\text{C}$ under rated load.

9. Surge test

The adapter will not been damaged and must pass L-N: 2KV, L-PE: 4KV, N-PE: 4KV,1.2/50us +-5 times 60s

 Linkpower Electronics Co., Ltd.		Approved by	Checked by	Designed by	Prepared by
Specification		Department		R&D	
Type	ASW0081-1220002W ADAPTER	Page		6	
		Date		2016-04-21	

10. Reliability

10.1 High temperature storage test

The adapter shall be stored at temperature of $40\pm 2^{\circ}\text{C}$ for 24hours,
Clause 5.1, 5.4, 7,12.1 shall be satisfied.

10.2 Low temperature storage test

The adapter shall be stored at temperature of $0\pm 2^{\circ}\text{C}$ for 24hours,
Clause 5.1, 5.4, 7,12.1 shall be satisfied.

11. Caution

- 11.1 Risk of electric shock
- 11.2 For indoor use only
- 11.3 Do not open the unit
- 11.4 Dry location use only

12. Mechanical Performance

12.1 Appearance

The color of the case is accordant. Pour is not distinctly deficient, no markedly air bubbles, sinking and so on. The top and bottom case is tie in, no clearance, displacement $\leq 1\text{mm}$, lax $\leq 1\text{mm}$ and so on. After free drop, the case is close.

12.2 Cord bending test

The DC cord shall withstand weight of 500g, it swing from left to right at angle of 120 degree, 40 times per min, more than 1000 times.

12.3 Strain relief test

Fix the main part of the adapter, Plug and cord at their normal position applied a weight of 5 Kg to output for 15 seconds.

 Linkpower Electronics Co., Ltd.		Approved by	Checked by	Designed by	Prepared by
Specification		Department		R&D	
Type	ASW0081-1220002W ADAPTER	Page		7	
		Date		2018-12-26	

12.4 Vibration test

Frequency:10-55Hz Amplitude:0.15mm,
Time:10times per directions (X,Y,and Z).

12.5 Physical dimensions

The dimension of the adapter is within
100mm(L) x48mm(W) x 33mm(H).

12.6 Free drop test

Dropping from a height of 60cm to a wood plate of 20mm thickness. And 1 time each side total 6 times.

12.7 Connector

DC output plug(mm)	2pin, shown on drawing
--------------------	------------------------

13.Attachment

13.1 Label

13.1.1 Material: Laser;

13.1.2 L/No.: CY1616 is the track date,

“16” ,means year, “16” means week;

13.1.3 Size & Content;



13.2 DC cord drawing

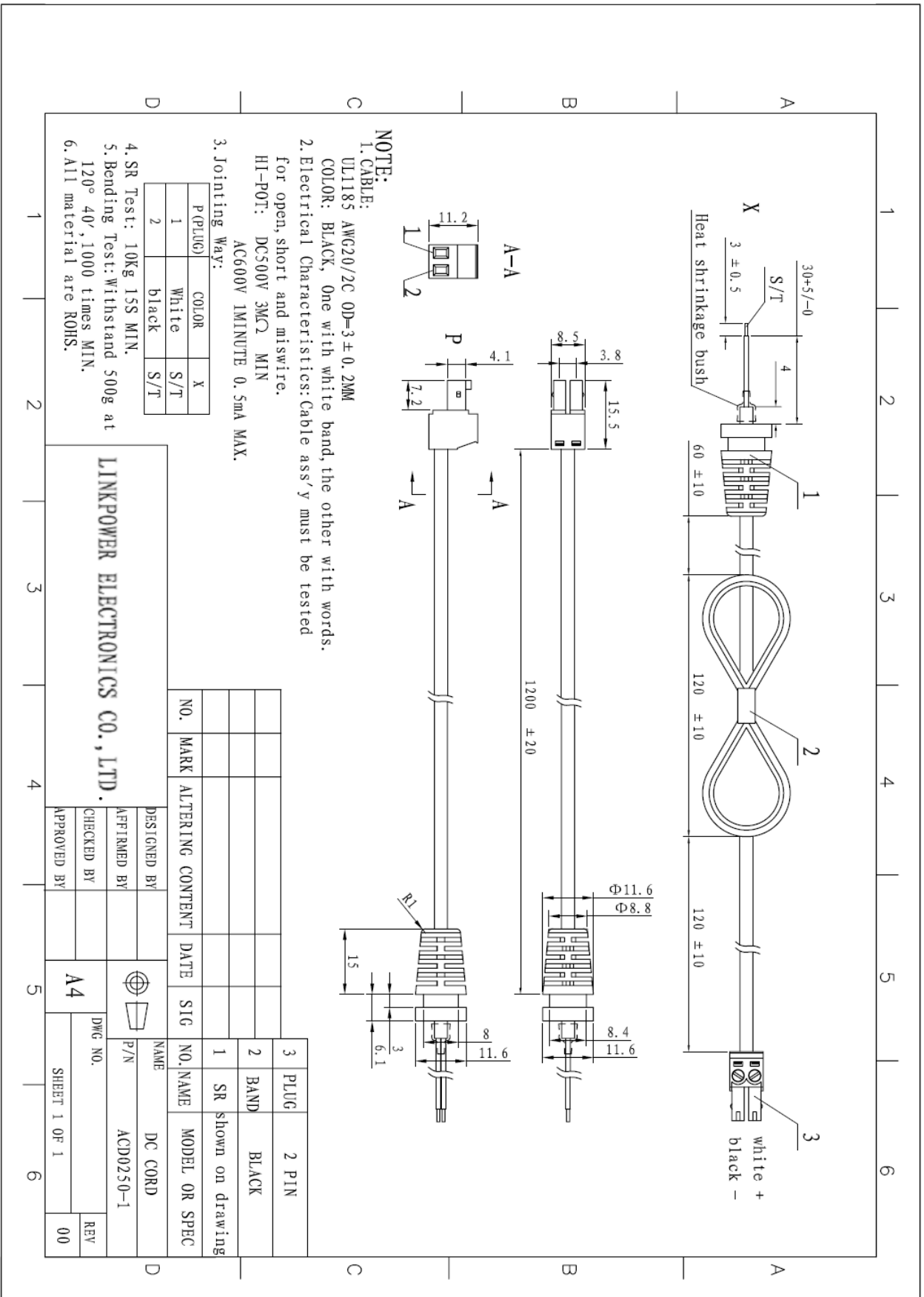

13.3 Appearance drawing

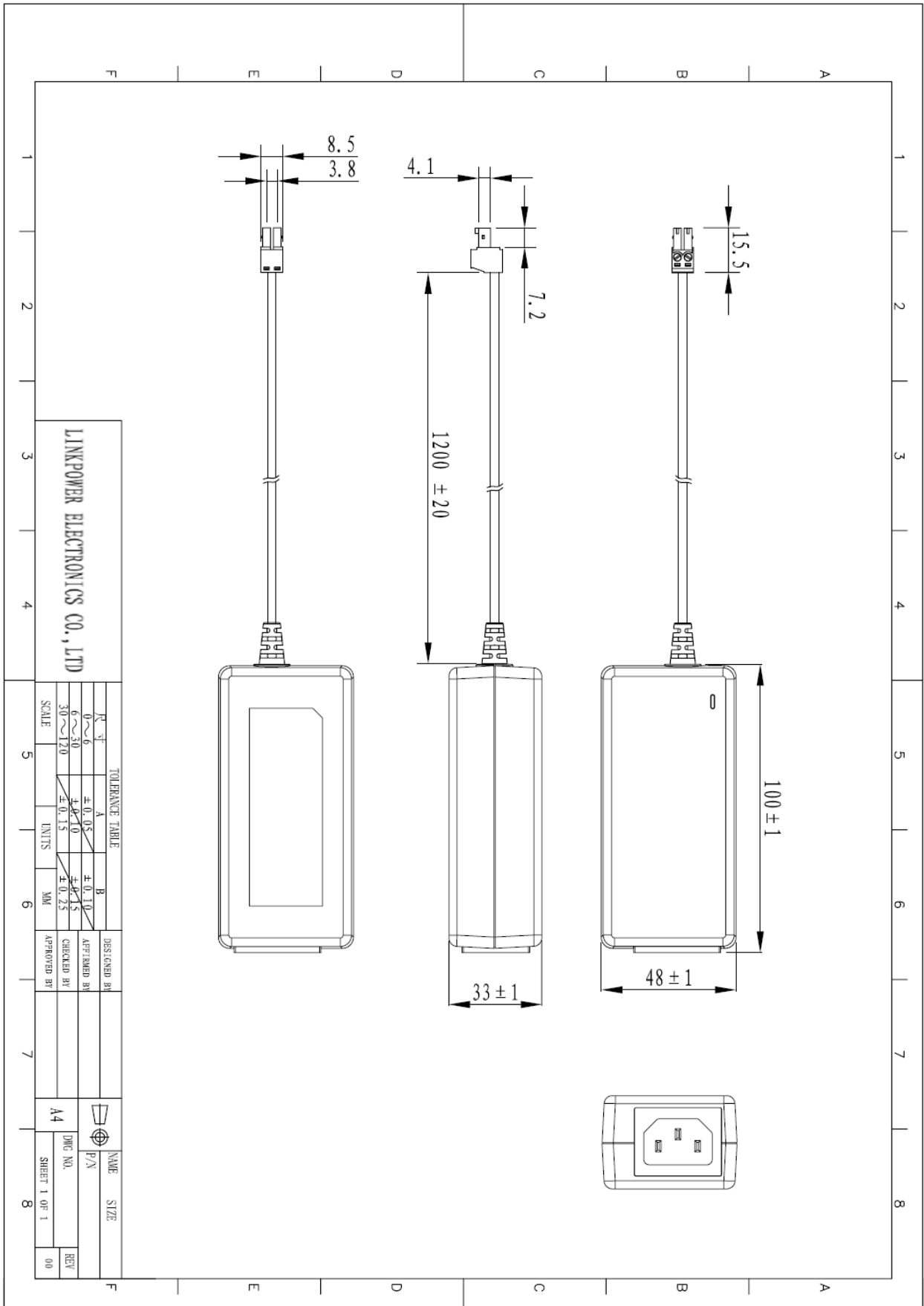

14. Package drawing

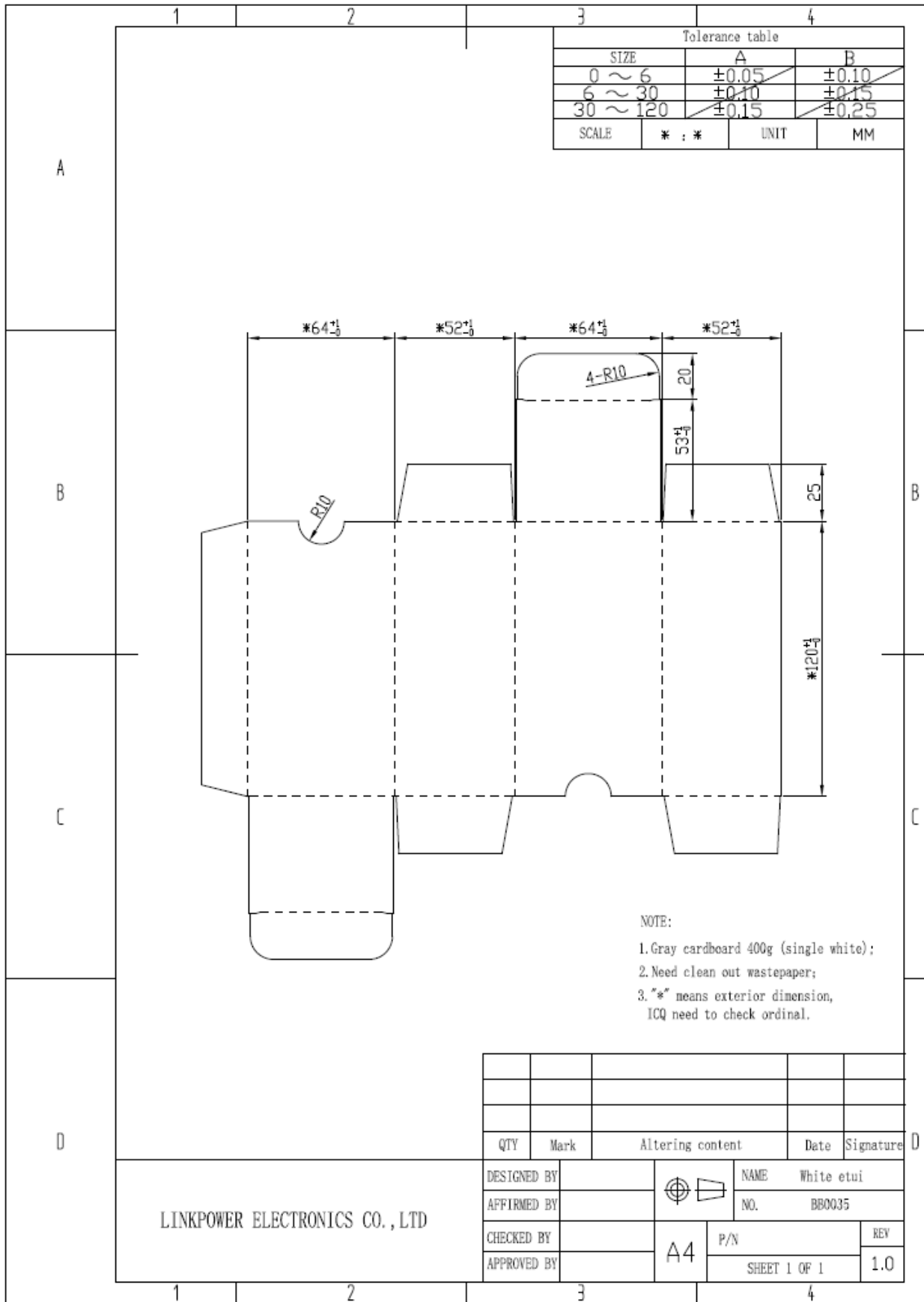

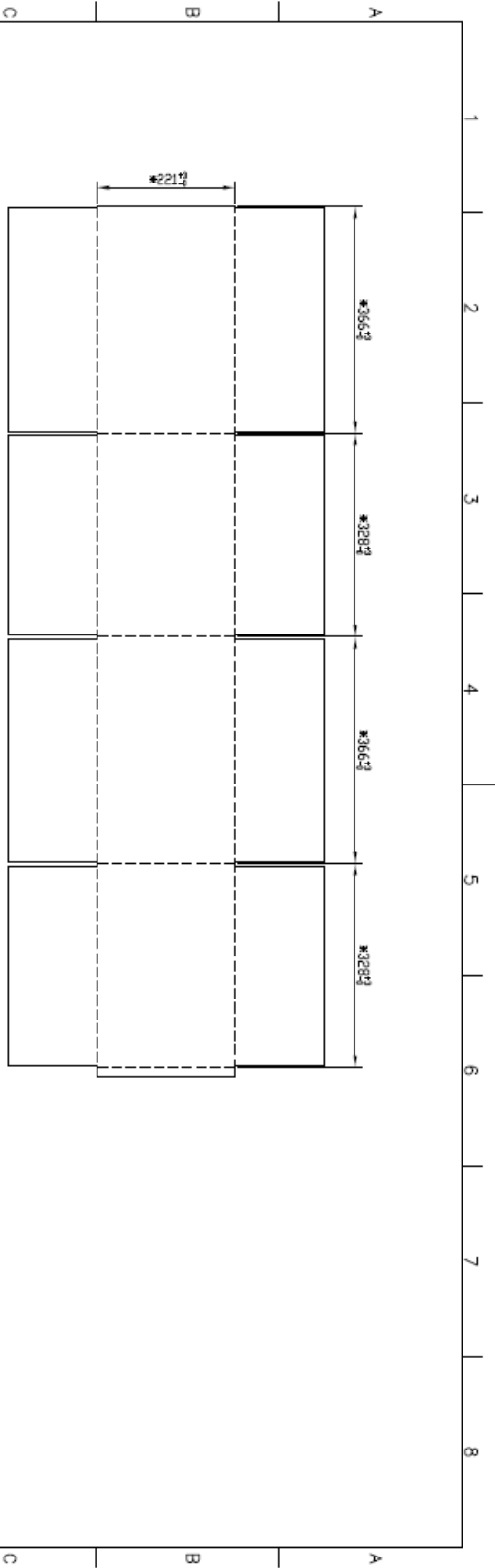

Name	Drawing NO.	SPEC	NUM
carton box	BR0034	598*328*221 (Internal size)	1
inches	BR0035	23*12*8.64	60
clipboard		360*423*3.0t	2
bag		180*120*0.03t	60

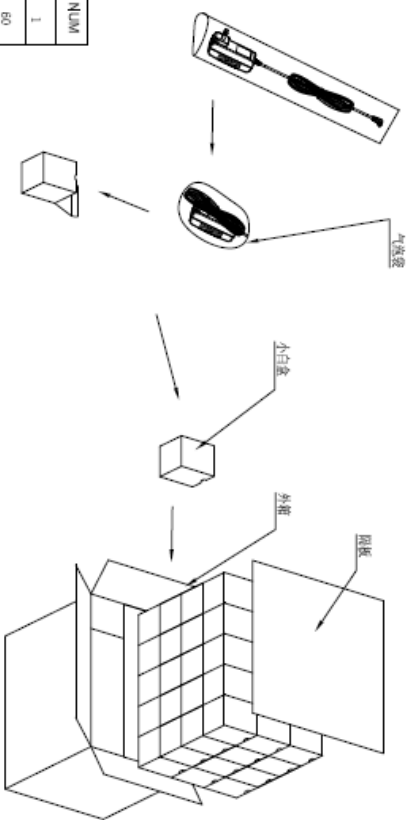

- Note:
1. The material of carton is five layers regular paper (A+B 7.0t);
 2. Need clean out wastepaper;
 3. The outer surface of carton is waterproofed;
 4. The break strength of box is 12kg/cm;
 5. The size with "*" are the internal size;
 6. 60PCS per carton;
 7. External dimensions are 366 * 328 * 221 (For reference).

QTY	Mark	Altering content	Date	Signature
1				

LINKPOWER ELECTRONICS CO., LTD

Tolerance table		DESIGNED BY		APPROVED BY	
SIZE	A	B	NAME	DATE	REV
0 ~ 5	±0.05	±0.10	BR0034		
6 ~ 30	±0.10	±0.15			
30 ~ 120	±0.15	±0.25			
SCALE	UNIT	MM	APPROVED BY		

A4 P/N SHEET 1 OF 1 1.0