

DS-2CE56D0T-IR (C) 2 MP Camera



- 2 MP, 1920 × 1080 resolution
- 2.8 mm, 3.6 mm, 6 mm fixed focal lens
- Smart IR, up to 25 m IR distance
- IP67



Specification

| Camera | |
|--------------------------|---|
| Image Sensor | 2 MP CMOS |
| Signal System | PAL/NTSC |
| Resolution | 1920 (H) × 1080 (V) |
| Frame Rate | TVI: 1080P@30fps, 1080P@25fps |
| Min. illumination | 0.01 Lux@(F1.2, AGC ON), 0 Lux with IR |
| Shutter Time | PAL: 1/25 s to 1/50, 000 s NTSC: 1/30 s to 1/50, 000 s |
| Lens | 2.8 mm, 3.6 mm, 6 mm fixed lens |
| Field of View | 2.8 mm, horizontal FOV: 101°, vertical FOV: 60°, diagonal FOV: 122° 3.6 mm, horizontal FOV: 79.6°, vertical FOV: 43.5°, diagonal FOV: 93.7° 6 mm, horizontal FOV: 51.9°, vertical FOV: 30°, diagonal FOV: 58.8° |
| Lens Mount | M12 |
| Day & Night | ICR |
| WDR (Wide Dynamic Range) | Digital WDR |
| Angle Adjustment | Pan: 0 to 360°, Tilt: 0 to 75°, Rotation: 0 to 360° |
| Menu | |
| Image Mode | STD/HIGH-SAT |
| AGC | Yes |
| Day/Night Mode | Auto/Color/BW (Black and White) |
| White Balance | Auto/Manual |
| AE (Auto Exposure) Mode | DWDR/BLC/HLC/Global |
| Noise Reduction | 2D DNR |
| Language | English |
| Function | Brightness, Sharpness, Smart IR |
| Interface | |
| Video Output | 1 HD analog output |
| General | |
| Operating Conditions | -40 °C to 60 °C (-40 °F to 140 °F), humidity 90% or less (non-condensing) |
| Power Supply | 12 VDC ± 25% |
| Power Consumption | Max. 3 W |
| Protection Level | IP67 |
| Material | Main Body: Metal Enclosure: Plastic |
| IR Range | Up to 25 m |
| Communication | HIKVISION-C |
| Dimensions | Φ 89.9 mm × 70.1 mm (Φ 3.54" × 2.76") |
| Weight | Approx. 173 g (0.38 lb.) |

Available Model

DS-2CE56D0T-IR (C)

Dimension

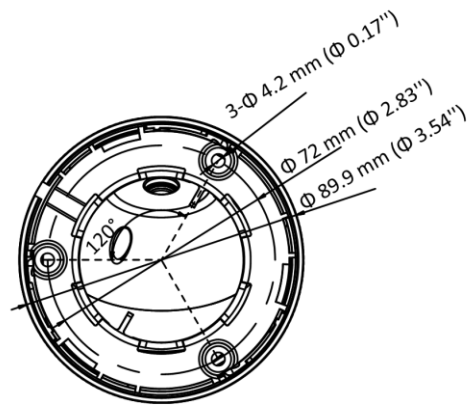
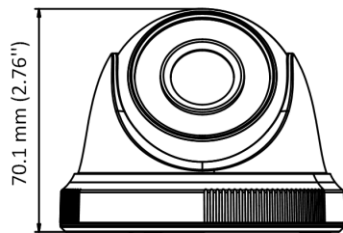

Accessory

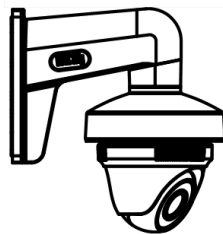

DS-1272ZJ-110-TRS
Wall Mount

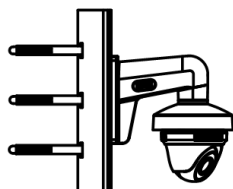
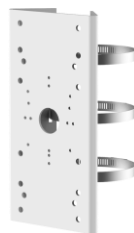

DS-1275ZJ-SUS
Vertical Pole Mount

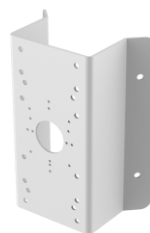

DS-1276ZJ-SUS
Corner Mount

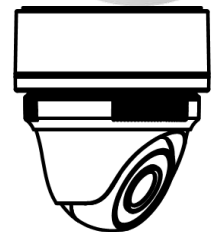

DS-1280ZJ-XS
Junction Box

Distributed by

**HIKVISION®****Headquarters**

No.555 Qianmo Road, Binjiang District,
Hangzhou 310051, China
T +86-571-8807-5998
overseasbusiness@hikvision.com

Hikvision USA
T +1-909-895-0400
sales.usa@hikvision.com

Hikvision Australia
T +61-2-8599-4233
salesau@hikvision.com

Hikvision India
T +91-22-28469900
sales@pramahikvision.com

Hikvision Canada
T +1-866-200-6690
sales.canada@hikvision.com

Hikvision Thailand
T +662-275-9949
sales.thailand@hikvision.com

Hikvision Europe
T +31-23-5542770
sales.eu@hikvision.com

Hikvision Italy
T +39-0438-6902
info.it@hikvision.com

Hikvision Brazil
T +55 11 3318-0050
Latam.support@hikvision.com

Hikvision Turkey
T +90 (216)521 7070- 7074
sales.tr@hikvision.com

Hikvision Malaysia
T +601-7652-2413
sales.my@hikvision.com

Hikvision UK & Ireland
T +01628-902140
sales.uk@hikvision.com

Hikvision South Africa
Tel: +27 (10) 0351172
sale.africa@hikvision.com

Hikvision France
T +33(0)1-85-330-450
info.fr@hikvision.com

Hikvision Kazakhstan
T +7-727-9730667
nikia.panfilov@hikvision.ru

Hikvision Vietnam
T +84-974270888
sales.vt@hikvision.com

Hikvision UAE
T +971-4-4432090
salesme@hikvision.com

Hikvision Singapore
T +65-6684-4718
sg@hikvision.com

Hikvision Spain
T +34-91-737-16-55
info.es@hikvision.com

Hikvision Tashkent
T +99-87-1238-9438
uzb@hikvision.ru

Hikvision Hong Kong
T +852-2151-1761
info.hk@hikvision.com

Hikvision Russia
T +7-495-669-67-99
sateru@hikvision.com

Hikvision Korea
T +82-(0)31-731-8817
sales.korea@hikvision.com

Hikvision Poland
T +48-22-460-01-50
info.pl@hikvision.com

Hikvision Indonesia
T +62-21-2933759
Sales.Indonesia@hikvision.com

Hikvision Colombia
sales.colombia@hikvision.com