



DS-C10S-SXXT Series Video Wall Controller

User Manual

© 2020 Hangzhou Hikvision Digital Technology Co., Ltd. All rights reserved.

This Manual is the property of Hangzhou Hikvision Digital Technology Co., Ltd. or its affiliates (hereinafter referred to as “Hikvision”), and it cannot be reproduced, changed, translated, or distributed, partially or wholly, by any means, without the prior written permission of Hikvision. Unless otherwise expressly stated herein, Hikvision does not make any warranties, guarantees or representations, express or implied, regarding to the Manual, any information contained herein.

About this Manual

The Manual includes instructions for using and managing the Product. Pictures, charts, images and all other information hereinafter are for description and explanation only. The information contained in the Manual is subject to change, without notice, due to firmware updates or other reasons. Please find the latest version of this Manual at the Hikvision website (<https://www.hikvision.com/>).

Please use this Manual with the guidance and assistance of professionals trained in supporting the Product.

Trademarks Acknowledgement

- **HIKVISION** and other Hikvision’s trademarks and logos are the properties of Hikvision in various jurisdictions.
- Other trademarks and logos mentioned are the properties of their respective owners.

Legal Disclaimer

TO THE MAXIMUM EXTENT PERMITTED BY APPLICABLE LAW, THIS MANUAL AND THE PRODUCT DESCRIBED, WITH ITS HARDWARE, SOFTWARE AND FIRMWARE, ARE PROVIDED “AS IS” AND “WITH ALL FAULTS AND ERRORS”. HIKVISION MAKES NO WARRANTIES, EXPRESS OR IMPLIED, INCLUDING WITHOUT LIMITATION, MERCHANTABILITY, SATISFACTORY QUALITY, OR FITNESS FOR A PARTICULAR PURPOSE. THE USE OF THE PRODUCT BY YOU IS AT YOUR OWN RISK. IN NO EVENT WILL HIKVISION BE LIABLE TO YOU FOR ANY SPECIAL, CONSEQUENTIAL, INCIDENTAL, OR INDIRECT DAMAGES, INCLUDING, AMONG OTHERS, DAMAGES FOR LOSS OF BUSINESS PROFITS, BUSINESS INTERRUPTION, OR LOSS OF DATA, CORRUPTION OF SYSTEMS, OR LOSS OF DOCUMENTATION, WHETHER BASED ON BREACH OF CONTRACT, TORT (INCLUDING NEGLIGENCE), PRODUCT LIABILITY, OR OTHERWISE, IN CONNECTION WITH THE USE OF THE PRODUCT, EVEN IF HIKVISION HAS BEEN ADVISED OF THE POSSIBILITY OF SUCH DAMAGES OR LOSS.

YOU ACKNOWLEDGE THAT THE NATURE OF INTERNET PROVIDES FOR INHERENT SECURITY RISKS, AND HIKVISION SHALL NOT TAKE ANY RESPONSIBILITIES FOR ABNORMAL OPERATION, PRIVACY LEAKAGE OR OTHER DAMAGES RESULTING FROM CYBER-ATTACK, HACKER ATTACK, VIRUS INSPECTION, OR OTHER INTERNET SECURITY RISKS; HOWEVER, HIKVISION WILL PROVIDE TIMELY TECHNICAL SUPPORT IF REQUIRED.

YOU AGREE TO USE THIS PRODUCT IN COMPLIANCE WITH ALL APPLICABLE LAWS, AND YOU ARE SOLELY RESPONSIBLE FOR ENSURING THAT YOUR USE CONFORMS TO THE APPLICABLE LAW. ESPECIALLY, YOU ARE RESPONSIBLE, FOR USING THIS PRODUCT IN A MANNER THAT DOES NOT INFRINGE ON THE RIGHTS OF THIRD PARTIES, INCLUDING WITHOUT LIMITATION, RIGHTS OF PUBLICITY, INTELLECTUAL PROPERTY RIGHTS, OR DATA PROTECTION AND OTHER PRIVACY RIGHTS. YOU SHALL NOT USE THIS PRODUCT FOR ANY PROHIBITED END-USES, INCLUDING THE DEVELOPMENT OR PRODUCTION OF WEAPONS OF MASS DESTRUCTION, THE DEVELOPMENT OR PRODUCTION OF CHEMICAL OR BIOLOGICAL WEAPONS, ANY ACTIVITIES IN THE CONTEXT RELATED TO ANY NUCLEAR EXPLOSIVE OR UNSAFE NUCLEAR FUEL-CYCLE, OR IN SUPPORT OF HUMAN RIGHTS ABUSES.

IN THE EVENT OF ANY CONFLICTS BETWEEN THIS MANUAL AND THE APPLICABLE LAW, THE LATER PREVAILS.

IN THE EVENT OF ANY CONFLICTS BETWEEN THIS MANUAL AND THE APPLICABLE LAW, THE LATER PREVAILS.

Regulatory Information

FCC Information

Please take attention that changes or modification not expressly approved by the party responsible for compliance could void the user's authority to operate the equipment.

FCC compliance: This equipment has been tested and found to comply with the limits for a Class A digital device, pursuant to part 15 of the FCC Rules. These limits are designed to provide reasonable protection against harmful interference when the equipment is operated in a commercial environment. This equipment generates, uses, and can radiate radio frequency energy and, if not installed and used in accordance with the instruction manual, may cause harmful interference to radio communications. Operation of this equipment in a residential area is likely to cause harmful interference in which case the user will be required to correct the interference at his own expense.

FCC Conditions

This device complies with part 15 of the FCC Rules. Operation is subject to the following two conditions:

1. This device may not cause harmful interference.
2. This device must accept any interference received, including interference that may cause undesired operation.

EU Conformity Statement

 This product and - if applicable - the supplied accessories too are marked with "CE" and comply therefore with the applicable harmonized European standards listed under the EMC Directive 2014/30/EU, the LVD Directive 2014/35/EU, the RoHS Directive 2011/65/EU.

 2012/19/EU (WEEE directive): Products marked with this symbol cannot be disposed of as unsorted municipal waste in the European Union. For proper recycling, return this product to your local supplier upon the purchase of equivalent new equipment, or dispose of it at designated collection points. For more information see: www.recyclethis.info

 2006/66/EC (battery directive): This product contains a battery that cannot be disposed of as unsorted municipal waste in the European Union. See the product documentation for specific battery information. The battery is marked with this symbol, which may include lettering to indicate cadmium (Cd), lead (Pb), or mercury (Hg). For proper recycling, return the battery to your supplier or to a designated collection point. For more information see: www.recyclethis.info

Industry Canada ICES-003 Compliance

This device meets the CAN ICES-3 (A)/NMB-3(A) standards requirements.

Applicable Models

This manual is applicable to the following products:

Model	Name
DS-C10S-S09T	Video Wall Controller
DS-C10S-S11T	
DS-C10S-S22T	

To simplify the description in this user manual, we make conventions as follows:

The iVMS-4200 video wall client software is defined as *software*.

The video wall controller (DS-C10S-SXXT) is defined as *controller* or *device*.



Click refers to pressing the left button of the mouse once, *double-click* refers to quickly pressing the left button of the mouse twice, *right-click* refers to pressing the right button of the mouse once.

About the Default

Item	Parameter	Default Value
Device	Login username and IP address	Default username: admin Default IP address: 192.0.0.64
SSH connection	Login username and password	Same as that of the device and synchronized with the device once changed

Symbol Conventions

The symbols that may be found in this document are defined as follows.

Symbol	Description
 NOTE	Provides additional information to emphasize or supplement important points of the main text.
 WARNING	Indicates a potentially hazardous situation, which if not avoided, could result in equipment damage, data loss, performance degradation, or unexpected results.
 DANGER	Indicates a hazard with a high level of risk, which if not avoided, will result in death or serious injury.

Safety Instructions



WARNING

- In the use of the product, you must be in strict compliance with the electrical safety regulations of the nation and region.
- This is a class A product and may cause radio interference in which case the user may be required to take adequate measures.
- Use the power adapter delivered with the device only.
- The power socket or power plug is used to disconnect power. Do not cover the power socket or power plug so that it can be easily moved.
- This equipment is not suitable for use in locations where children are likely to be present
- CAUTION: Risk of explosion if the battery is replaced by an incorrect type
- Improper replacement of the battery with an incorrect type may defeat a safeguard (for example, in the case of some lithium battery types).
- Do not dispose of the battery into fire or a hot oven, or mechanically crush or cut the battery, which may result in an explosion.
- Do not leave the battery in an extremely high temperature surrounding environment, which may result in an explosion or the leakage of flammable liquid or gas.
- Do not subject the battery to extremely low air pressure, which may result in an explosion or the leakage of flammable liquid or gas.
- Dispose of used batteries according to the instructions.
- If smoke, odor or noise rise from the device, turn off the power at once and unplug the power cable, and then please contact the service center.
- If the product does not work properly, please contact your dealer or the nearest service center.
- Never attempt to disassemble the product yourself. (We shall not assume any responsibility for problems caused by unauthorized repair or maintenance.)
- Please enhance the protection for personal information and data security as the device may be confronted with the network security problems when it is connected to the Internet. Please contact your dealer or the nearest service center once you find that there may be the network security problems.
- Do not drop the device or subject it to physical shock, and do not expose it to high electromagnetism radiation. Avoid the equipment installation on vibrations surface or places subject to shock (ignorance can cause equipment damage).
- Do not expose the device to the explosive situation.
- Keep clean and dry on the surface of the device.
- Do not touch the exposed connection points or components when the device is powered on.
- Do not place any naked flame sources, such as lit candles, on the device.
- Do not place any objects containing water or liquids on the device. Prevent the device from water dropping or splashing.
- Place the device in a well-ventilated, dust-free environment. Ensure that the air vents are not

covered by any objects such as newspapers, tablecloths, or curtains.

Table of Contents

Chapter 1 Introduction	12
1.1 Product Overview.....	12
1.2 Product Features	12
1.3 Panel Introduction.....	13
1.3.1 Front Panel.....	13
1.3.2 Rear Panel	14
1.3.3 Motherboard	17
1.3.4 Signal Input Module	18
1.3.5 Output Module	25
Chapter 2 Accessing via iVMS-4200 Video Wall Client Software	28
2.1 Software Overview	28
2.1.1 Working Environment	28
2.1.2 Performance	28
2.2 Software Installation	28
2.2.1 Installing the Software.....	28
2.2.2 Uninstalling the Software	29
2.3 User Registration and Login	29
2.3.1 Registration	29
2.3.2 Login	30
2.4 Using the Wizard for Basic Configuration	30
2.5 Graphical User Interface Introduction.....	35
Chapter 3 Configuring Controller via the Software	38
3.1 Video Wall Introduction	38
3.2 Managing Video Wall Controller.....	40
3.2.1 Activating the Video Wall Controller.....	40
3.2.2 Adding the Video Wall Controller	41
3.3 Configuring Remote Settings	42
3.3.1 Configuring System Settings	43

3.3.2 Configuring Network Settings	46
3.3.3 Configuring Event Settings.....	46
3.3.4 Configuring Video Display Settings	46
3.3.5 Configuring Other Settings	49
3.4 Screen Control.....	57
3.5 Managing User Accounts.....	58
3.6 Configuring System Settings	59
3.6.1 Configuring General Settings	59
3.6.2 Configuring File Saving Path	60
Chapter 4 Managing Video Wall via the Software	61
4.1 Configuring Video Wall.....	61
4.1.1 Adding a Video Wall	61
4.1.2 Linking Video Output to the Video Wall.....	64
4.1.3 Modifying Output Resolution	65
4.1.4 Setting Virtual Screen	68
4.2 Managing Signal Sources and Cameras.....	70
4.2.1 Managing Signal Sources	70
4.2.2 Managing Cameras.....	72
4.3 Displaying Signals on the Video Wall	76
4.3.1 Live View in Live View List	76
4.3.2 Live View in Roaming Window.....	77
4.3.3 Displaying on the Video Wall	78
4.3.4 Opening the Window via Coordinate.....	80
4.4 Managing the Scene.....	81
4.4.1 Adding a Scene	81
4.4.2 Modifying the Scene	81
4.4.3 Saving the Video Wall Layout to the Scene	82
4.4.4 Calling a Scene	82
4.4.5 Deleting a Scene.....	83
4.5 Managing the Plan	83

4.5.1 Adding a Plan	83
4.5.2 Calling a Plan	85
4.5.3 Modifying a Plan	86
4.6 PTZ Control	86
4.6.1 Controlling Network Signal Source	87
4.6.2 Controlling Local Signal Source	88
4.7 Configuring Advanced Settings	88
4.7.2 Mirroring Video Wall	96
4.7.3 Configuring Virtual LED	97
4.7.4 Configuring Background Picture	99
4.8 Configuring RSC Server	100
4.8.1 Setting RSC Server	100
4.8.2 Remote Interaction	102
4.9 Setting the Custom Resolution on the Computer	105
4.10 Stream Media Server Configuration	106
4.10.1 Installing Stream Media Server	106
4.10.2 Running Stream Media Server	107
4.10.3 Adding Stream Media Server	107
4.10.4 Configuring Stream Media Server	108
Chapter 5 Searching Logs	111
5.1 Searching Log Files	111
5.2 Filtering Log Files	111
5.3 Exporting Log Files	112
Chapter 6 Accessing via Web Client	113
6.1 Login	113
6.2 Configuring Encoding Devices	113
6.2.1 Adding an Encoding Device	113
6.2.2 Modifying an Encoding Device	116
6.2.3 Deleting an Encoding Device	117
6.3 Configuring Video Wall	117

6.4 Configuring Decoding Output	118
6.4.1 Configuring BNC Output	错误!未定义书签。
6.5 Decoding Video on Video Wall	119
6.5.1 Interface Description	119
6.5.2 Dragging Channels to the Video Wall	121
6.5.3 Opening Window via Coordinate	122
6.5.4 Managing Decoding	124
6.5.5 Switching Encoding Channel	126
6.5.6 Configuring Auto-Switch of Cameras	126
6.5.7 Roaming Window	126
6.5.8 Zooming in/out Roaming Windows	127
6.5.9 Configuring Scene	129
6.6 Configuration	131
6.6.1 System Configuration	131
6.6.2 Security Service Configuration	132
6.6.3 Network Configuration	133
6.6.4 System Maintenance	133
Chapter 7 Accessing via iVMS-4510 HD Client Software	135
7.1 Login	135
7.2 Select the Video Wall	136
7.3 Display Signals on the Video Wall	136
7.4 Window Operation	136
7.4.1 Resizing a Window	136
7.4.2 Window Roaming	138
7.4.3 Stick a Window at Bottom	138
7.4.4 Divide a Window	138
7.5 Smart Scaling on the Video Wall	138
7.6 Manage the Scene	139
7.6.1 Add a Scene	139

7.6.2 Save the Video Wall Layout to the Scene	140
7.6.3 Call a Scene	141
7.7 Call a Plan.....	141
7.8 Other Operation	142
7.8.1 Mirroring Between Video Wall Areas.....	142
7.8.2 Refresh.....	145
7.8.3 Virtual LED Screen	145
7.8.4 Preview	146
7.8.5 Logout.....	147
7.8.6 About	147

Chapter 1 Introduction

1.1 Product Overview

DS-C10S-SXXT series video wall controller is a high-performance image processing device that can realize the access and real-time processing of multiple signal sources. It can be applied to both the LED screen with small pixel pitch and the normal screen. As the core display control device, it is mainly used in Video Wall system for dynamic video display on multiple display units simultaneously.

1.2 Product Features

- A signal source can be displayed on the $M \times N$ ($M \geq 1, N \geq 1$) display units.
- Multiple signal sources are supported, including VGA, DVI, HDMI, BNC, SDI, YpbPr, DP, HDBaseT. Up to $3840 \times 2160@30$ Hz resolution is supported for HDMI, DP and HDBaseT signal inputs.
- Distributed network signal sources configurable to raise the signal source capacity and transmission distance.
- Live view in the roaming window and live view list.
- Fluent video output without frame extraction to guarantee the lossless output of 60 frames.
- An enhanced network decoding board supports H.264 and H.265 compression standard and can display network signal of 2-ch@8.0 MP, 2-ch@6.0 MP, 2-ch@5.0 MP, 8-ch@1080p, 16-ch@720p and 32-ch@D1 and local video files.
- Auto sub-stream decoding if the output resolution of decoding window is lower than 640×640 .
- Supports 1/4/9/16 window division modes and full-screen switch of the window. (Unavailable for the LED mode)
- The window can be kept sticking on top without being affected by the operations of other windows and kept open without being affected by the scene or plan configuration.
- Up to 4 image layers can be displayed on one screen in normal mode, including one virtual LED image layer and a background layer.
- The LED background color is adjustable. The resolution of background layer is up to 16384×8192 .
- Tile mode available and the video layers can be extended to 16 layers in tile mode.
- The tile mode can be saved in the scene.

- Video wall mirror configurable to mirror the content of one video wall area to another area.
- Users have the permission to manage the signal sources and video wall.
- Built-in matrix feature for opening a signal source on several windows simultaneously.
- Matrix protocol of ZT1.0, ZT2.0, Extron, Creator and HIK_CVBS_96P supported and up to 4 matrixes with maximum 512 input channels of each matrix supported.
- Supports crossing-window video roaming. (Unavailable for the tile mode)
- Supports adjusting the output to match the virtual output of client software with real output of controller.
- Up to 512 devices can be managed and up to 6 virtual video walls can be displayed by a client server.
- Remote control via iOS client server, Android client server and IE browser.
- Supports opening windows to display video signal, with the window position and size adjustable.
- Supports SADP searching active IP address and resetting the password of administrator.
- The fan speed of the chassis is self-adaptive to the temperature.
- Supports both the LED screen mode with small pixel pitch and the normal screen mode.
- Self-adaptive to the configured LED resolution.
- Supports custom resolution access of DP, DVI and HDMI signal sources and characters overlap.
- Device running status, sub-board status, and fan status can be checked.
- Supports remote interaction.
- Compatible with wireless projection.
- 4K outputs support joint display.
- Scene switching for local signal sources can be done in seconds without black screens.
- Image lossless collecting, transmitting and displaying without color cast, color bleed and word blur.

1.3 Panel Introduction

1.3.1 Front Panel

Refer to the following figures and table for the front panel of DS-C10S-S09T, DS-C10S-S11T and DS-C10S-S22T.

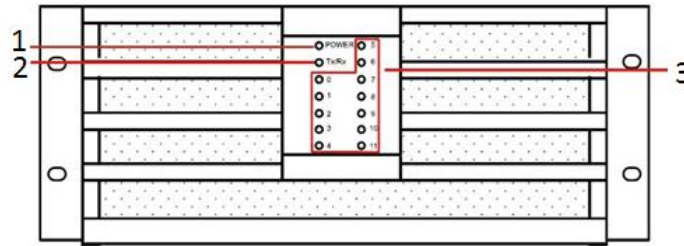

Figure 1-1 DS-C10S-S09T and DS-C10S-S11T Front Panel

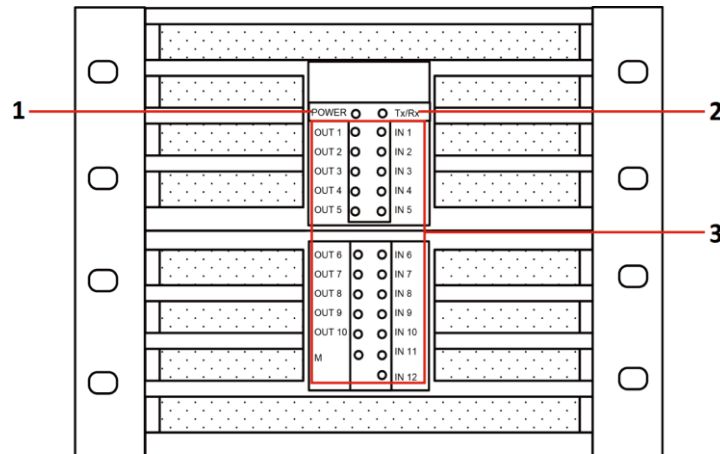

Figure 1-2 DS-C10S-S22T Front Panel

Table 1-1 Front Panel Description

No.	Name	Description
1	Power Indicator	Turns red when the controller is powered up.
2	Network Indicator	Flashes green when network connection is functioning normally.
3	Board Indicator	Flashes green when the boards are working normally.

1.3.2 Rear Panel

Refer to Figure 1-3 and Table 1-2 for the rear panel of DS-C10S-S09T.

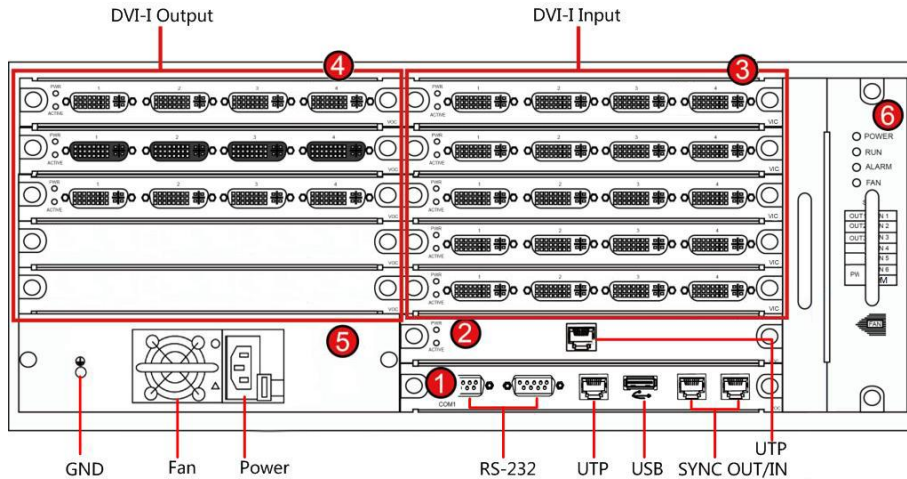



Figure 1-3 DS-C10S-S09T Rear Panel

Table 1-2 DS-C10S-S09T Rear Panel Description

No.	Area	Description
1	Motherboard	Includes USB (reserved), UTP, and RS-232 interfaces.
2/3	Signal Input Module	With 6 slots for signal input boards, supporting VGA/DVI/HDMI/DP/YPbPr/HDBase/SDI and network signal decoding
4	Signal Output Module	With 3 slots for signal output boards, supporting DVI/VGA/HDMI output
5	Power	<p>Contains the physical power switch, power plug and power supply fan.</p> <p> NOTE</p> <p>Ensure that the device is grounded and the AC power supply is stable and within the range of the rated voltage of the unit. If the AC power is likely to have spikes or power dips, use power line conditioning or an uninterrupted power supply (UPS).</p>
6	Fan	<p>There are four indicators on the fan board. They are the POWER, RUN, ALARM and FAN. When the fan is working normally, only the RUN and POWER indicators light. When the fan is abnormal, the FAN indicator lights.</p> <p> NOTE</p> <p>Hot swapping is forbidden because it may cause damage to the fan.</p>

Refer to Figure 1-4, Figure 1-5 and Table 1-3 for the rear panel of DS-C10S-S11T and DS-C10S-S22T.

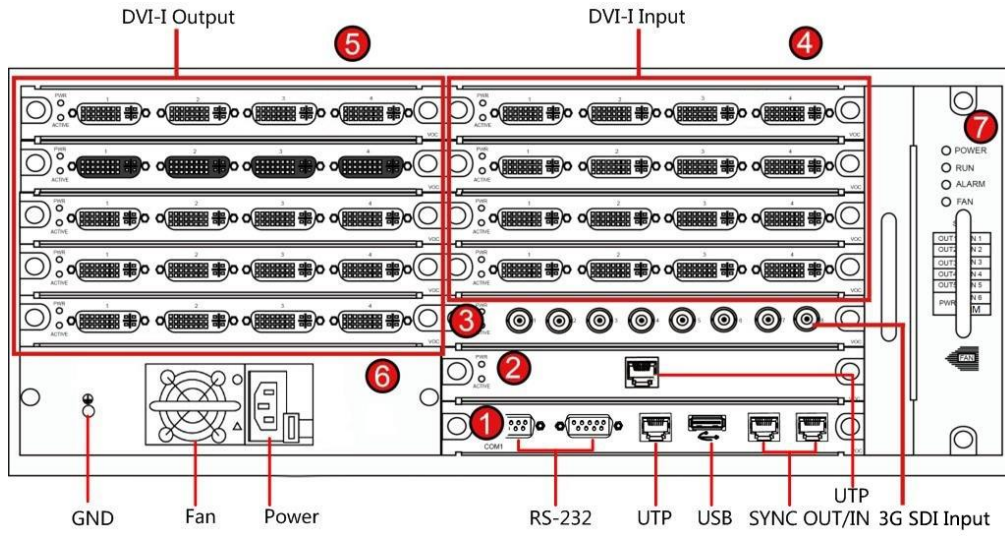

Figure 1-4 DS-C10S-S11T Rear Panel

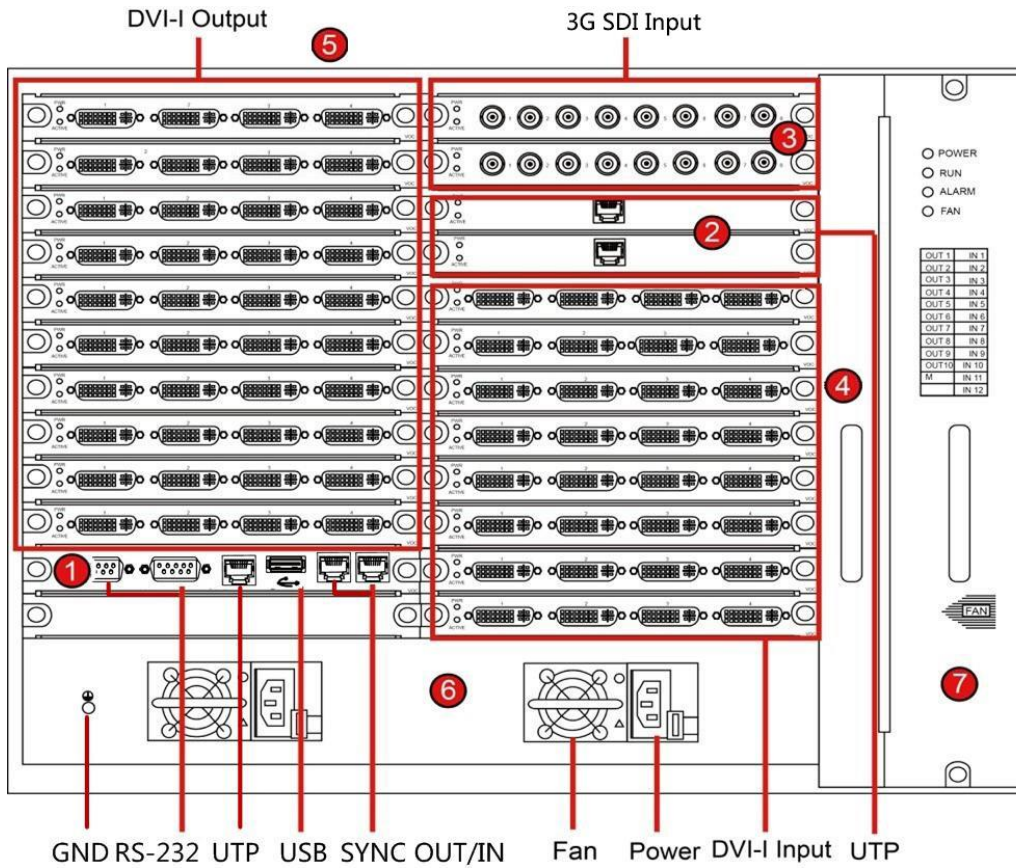



Figure 1-5 DS-C10S-S22T Rear Panel

Table 1-3 DS-C10S-S11T/22T Rear Panel Description

No.	Name	Description
1	Motherboard	Includes USB, UTP, and RS-232 interfaces.
2	Network Decoding Board	With UTP interfaces
3	SDI Input Board	With SDI input interfaces
4	DVI-I Input Board	With DVI-I input interfaces
5	DVI-I Output Board	With DVI-I output interfaces
6	Power	<p>Contains the physical power switch, power plug and power supply fan.</p> <p> NOTE</p> <p>Ensure that the device is grounded and the AC power supply is stable and within the range of the rated voltage of the unit. If the AC power is likely to have spikes or power dips, use power line conditioning or an uninterrupted power supply (UPS).</p>
7	Fan	<p>There are four indicators on the fan board. They are the POWER, RUN, ALARM and FAN. When the fan is working normally, only the RUN and POWER indicators light. When the fan is abnormal, the FAN indicator lights.</p> <p> NOTE</p> <p>Hot swapping is forbidden because it may cause damage to the fan.</p>

1.3.3 Motherboard

Refer to Table 1-4 for the model and description of the motherboard.

Table 1-4 Motherboard Model

Model	Module	Description
DS-C10S-MSUT	Motherboard	Motherboard of DS-C10S-S09T/S11T/S22T

Refer to the Figure 1-6 and Table 1-5 for the rear panel of the motherboard.

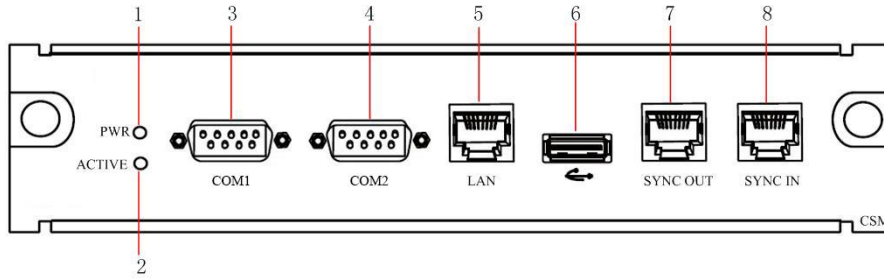

Figure 1-6 Motherboard Rear Panel

Table 1-5 Motherboard Description

No.	Name	Description
1	Power Indicator	Turns green when the board is powered up.
2	Working Status Indicator	Flashes green when the board is working normally.
3	RS-232 Serial Interface 1	Debugging interface
4	RS-232 Serial Interface 2	Control interface for screen control, matrix linkage, and keyboard
5	Network Interface	Interface for network transmission and control
6	USB Interface	Reserved interface
7	Synchronizing Signal Output	Output interface for synchronizing signal (reserved)
8	Synchronizing Signal Input	Input interface for synchronizing signal (reserved)

1.3.4 Signal Input Module

Refer to Table 1-6 for the models and description of the input boards.

Table 1-6 Input Board Model

Model	Module	Description
DS-C10S-DI4T	DVI Input Board	With 4 DVI input interfaces
DS-C10S-VI4T	VGA Input Board	With 4 VGA input interfaces  NOTE The VGA to DVI adaptor is required for VGA input.
DS-C10S-HI4T	HDMI Input Board	With 4 HDMI 1.4 input interfaces
DS-C10S-YI4T	YPbPr Input Board	With 4 YPbPr input interfaces

		 NOTE The YPbPr to DVI adaptor is required for YPbPr input.
DS-C10S-DPI4T	DP (DisplayPort) Input Board	With 4 DP input interfaces
DS-C10S-HDBI4T	HDBaseT Input Board	With 4 HDBaseT input interfaces
DS-C10S-SIUT	Network Decoding Board	Decoding network signal with resolution at 2-ch@8 MP (low frame rate), 2-ch@6 MP, 2-ch@5 MP, 8-ch@1080p, 16-ch@720p or 32-ch@D1
DS-C10S-SDI4T	SDI Input Board	With 4 SDI input interfaces

For the rear panels of the input boards, refer to the following figures and tables.

DVI Input Board (DS-C10S-DI4T)

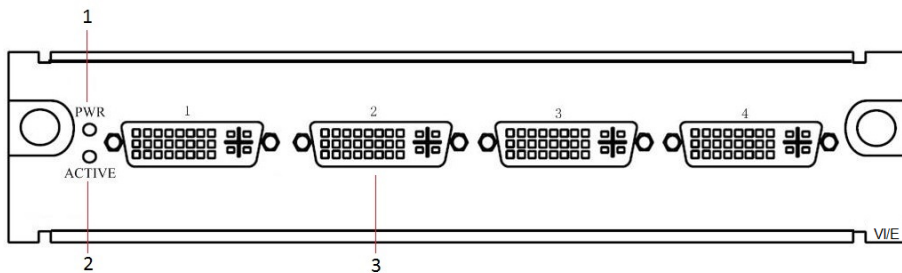



Figure 1-7 DS-C10S-DI4T Rear Panel

Table 1-7 DVI Input Board Description

No.	Name	Description
1	Power Indicator	Turns green when the board is powered up.
2	Working Status Indicator	Flashes green when the board is working normally.
3	DVI-I Input Interface	DVI-I input interface  NOTE The VGA to DVI adaptor is required for VGA input.

HDMI Input Board (DS-C10S-HI4T-HD)

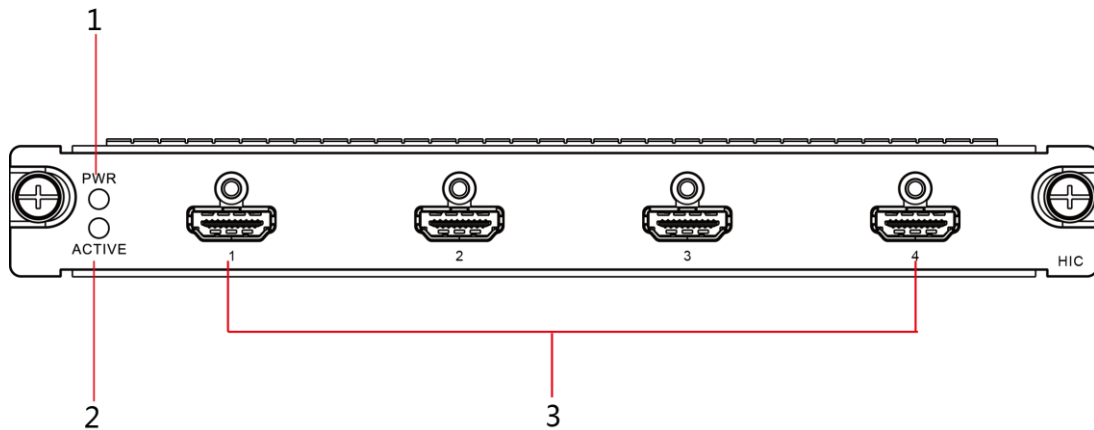

Figure 1-8 DS-C10S-HI4T-HD Rear Panel

Table 1-8 HDMI Input Board Description

No.	Name	Description
1	Power Indicator	Turns green when the board is powered up.
2	Working Status Indicator	Flashes green when the board is working normally.
3	HDMI Input Interface	Input interface for HDMI signal, with signal input of up to 1080@60 Hz resolution.

HDMI Input Board (DS-C10S-HI2T-4K)

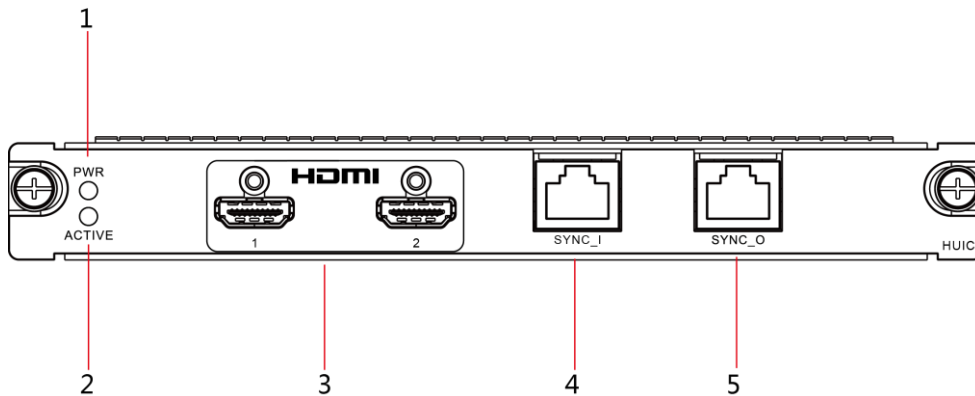

Figure 1-9 DS-C10S-HI2T-4K Rear Panel

Table 1-9 HDMI Input Board Description

No.	Name	Description
1	Power Indicator	Turns green when the board is powered up.
2	Working Status Indicator	Flashes green when the board is working normally.

3	HDMI Input Interface	Input interface for HDMI signals, with signal input of up to 3840 × 2160@30 Hz resolution.
4	SYNC Input Interface	RJ45-type SYNC interfaces for signal synchronization among multiple devices. <ul style="list-style-type: none"> ● Use a network cable to connect the SYNC interface of the SYNC box to the SYNC_I interface of the first device. ● Use a network cable to connect the SYNC_O interface of the first device to the SYNC_I interface of the second device. ● Use a network cable to connect the SYNC_O interface of the second device to the SYNC_I interface of the third device. The procedure is the same for the left devices.
5	SYNC Output Interface	

DP Input Board (DS-C10S-DPI2T-4K)

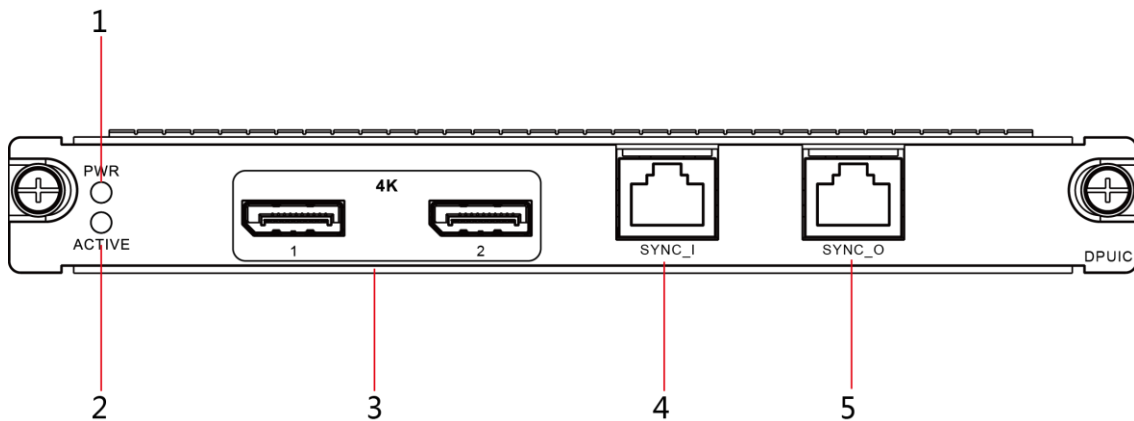

Figure 1-10 DS-C10S-DPI2T-4K Rear Panel

Table 1-10 HDMI Input Board Description

No.	Name	Description
1	Power Indicator	Turns green when the board is powered up.
2	Working Status Indicator	Flashes green when the board is working normally.
3	DP Input Interface	Input interface for DP signals, with signal input of up to 3840 × 2160@30 Hz resolution.
4	SYNC Input Interface	RJ45-type SYNC interfaces for signal synchronization among multiple devices <ul style="list-style-type: none"> ● Use a network cable to connect the SYNC interface of the SYNC box to the SYNC_I

		<p>interface of the first device</p> <ul style="list-style-type: none"> ● Use a network cable to connect the SYNC_O interface of the first device to the SYNC_I interface of the second device. ● Use a network cable to connect the SYNC_O interface of the second device to the SYNC_I interface of the third device. The procedure is the same for the left devices.
--	--	---

SYNC Box (DS-C10S-SYNC)

The SYNC box works with the HDMI input board DS-C10S-HI2T-4K and DP input board DS-C10S-DPI2T-4K to ensure image synchronization for joint display of multiple input sources.

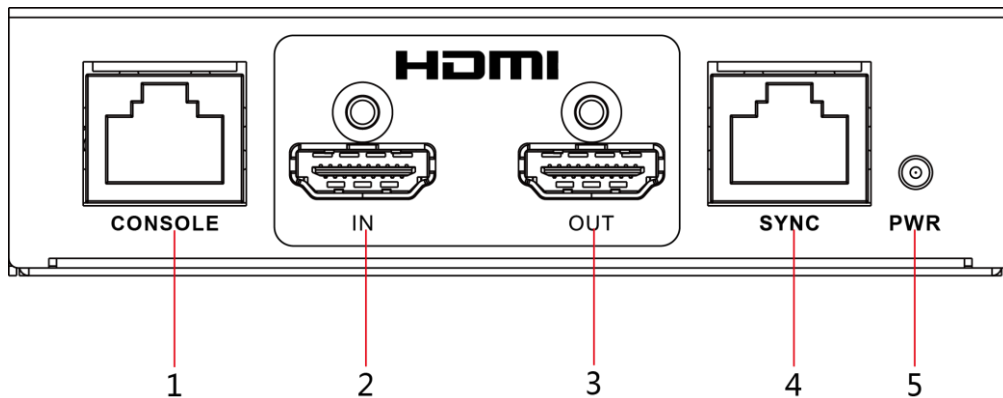

Figure 1-11 DS-C10S-SYNC Rear Panel

No.	Name	Description
1	CONSOLE Serial Port	Used for device debugging.
2	HDMI Input Interface	Input interface for YPbPr signal
3	HDMI Output Interface	Output interface for HDMI signal
4	SYNC Interface	RJ45-type SYNC interface for signal synchronization among 4K input boards
5	POWER Indicator	Steady on in working status for indicating power supplying status of the box

BNC Input Board (DS-C10S-BI8T)

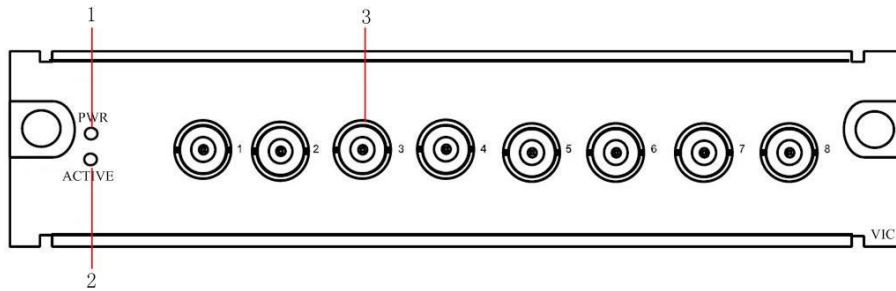

Figure 1-12 DS-C10S-BI8T Rear Panel

Table 1-11 BNC Input Board Description

No.	Name	Description
1	Power Indicator	Turns green when the board is powered up.
2	Working Status Indicator	Flashes green when the board is working normally.
3	BNC Input Interface	Input interface for BNC signal

YPbPr Input Board (DS-C10S-YI4T)

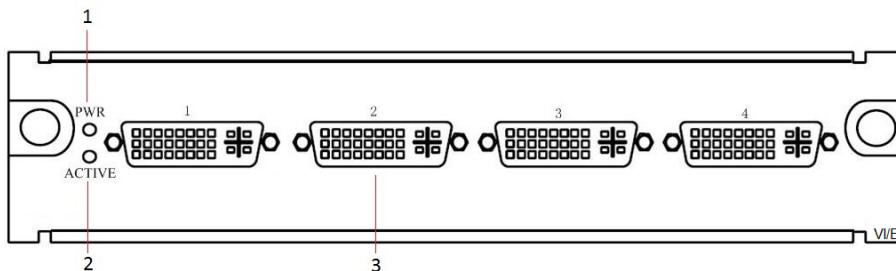

Figure 1-13 DS-C10S-YI4T Rear Panel

Table 1-12 YPbPr Input Board Description

No.	Name	Description
1	Power Indicator	Turns green when the board is powered up.
2	Working Status Indicator	Flashes green when the board is working normally.
3	YPbPr Input Interface	Input interface for YPbPr signal <div style="display: flex; align-items: center;"> NOTE The DVI to YPbPr adaptor is required for YPbPr input. </div>

HDBaseT Input Board (DS-C10S-HDBI4T)

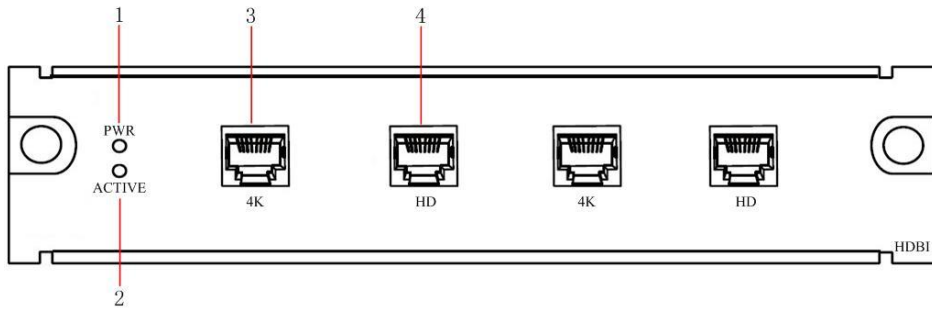



Figure 1-14 DS-C10S-HDBI4T Rear Panel

Table 1-13 HDBaseT Input Board Description

No.	Name	Description
1	Power Indicator	Turns green when the board is powered up.
2	Working Status Indicator	Flashes green when the board is working normally.
3	HDBaseT Input Interface	Input interface for HDBaseT signal  NOTE No. 1 and 3 interfaces support signal input of up to 3840 × 2160@30 Hz resolution.

Network Decoding Board (DS-C10S-SIUT)

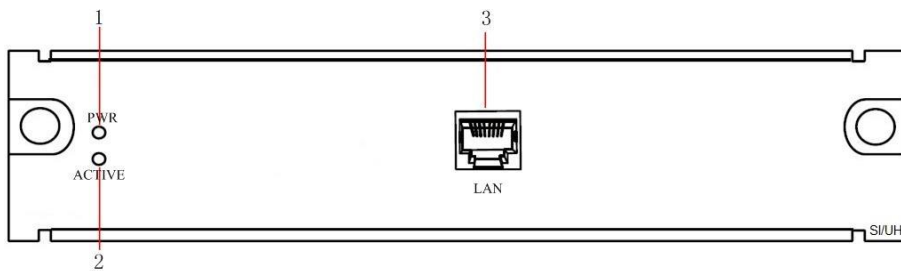

Figure 1-15 DS-C10S-SIUT Rear Panel

Table 1-14 Decoding Board Description

No.	Name	Description
1	Power Indicator	Turns green when the board is powered up.
2	Working Status Indicator	Flashes green when the board is working normally.
3	Network Interface	The decoding board should connect to the network independently.

1.3.5 Output Module

Refer to Table 1-14 for the models and description of the output boards.

Table 1-15 Output Board Model

Model	Module	Description
DS-C10S-DO4T	DVI Output Board	With 4 DVI output interfaces
DS-C10S-VO4T	VGA Output Board	With 4 VGA output interfaces NOTE The DVI to VGA adaptor is required for VGA output.
DS-C10S-HO4T	HDMI Output Board	With 4 HDMI output interfaces

Refer to the following figures and tables for the rear panels of the DVI and HDMI output boards.

DVI Output Board (DS-C10S-DO4T)

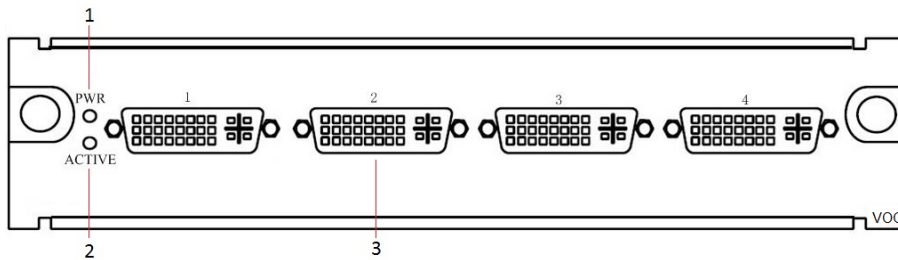

Figure 1-16 DS-C10S-DO4T Rear Panel

Table 1-16 DVI Output Board Description

No.	Name	Description
1	Power Indicator	Turns green when the board is powered up.
2	Working Status Indicator	Flashes green when the board is working normally.
3	DVI-I Output Interface	DVI-I output interface NOTE The DVI to VGA adaptor is required for VGA output. The DVI to HDMI adaptor is required for HDMI output.

HDMI Output Board (DS-C10S-HO4T)

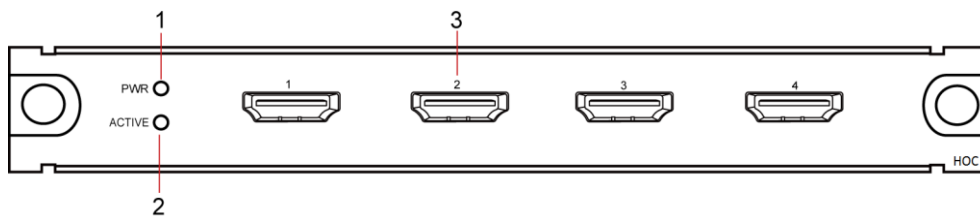

Figure 1-17 DS-C10S-HO4T Rear Panel

Table 1-17 HDMI Output Board Description

No.	Name	Description
1	Power Indicator	Turns green when the board is powered up.
2	Working Status Indicator	Flashes green when the board is working normally.
3	HDMI Output Interface	HDMI output interface

1.3.6 SYNC Box Connection

The SYNC box DS-C10S-SYNC only works with the HDMI input board DS-C10S-HI2T-4K and DP input board DS-C10SDPI2T-4K to ensure image synchronization for joint display of multiple input sources. Up to 4 input boards can be cascaded.

Connection method:

- Use a network cable to connect the SYNC interface of the SYNC box to the SYNC_I interface of the first device.
- Use a network cable to connect the SYNC_O interface of the first device to the SYNC_I interface of the second device.
- Use a network cable to connect the SYNC_O interface of the second device to the SYNC_I interface of the third device. The procedure is the same for the left devices.

The following figure uses the HDMI input board as an example to describe how to connect the SYNC box with the input boards.

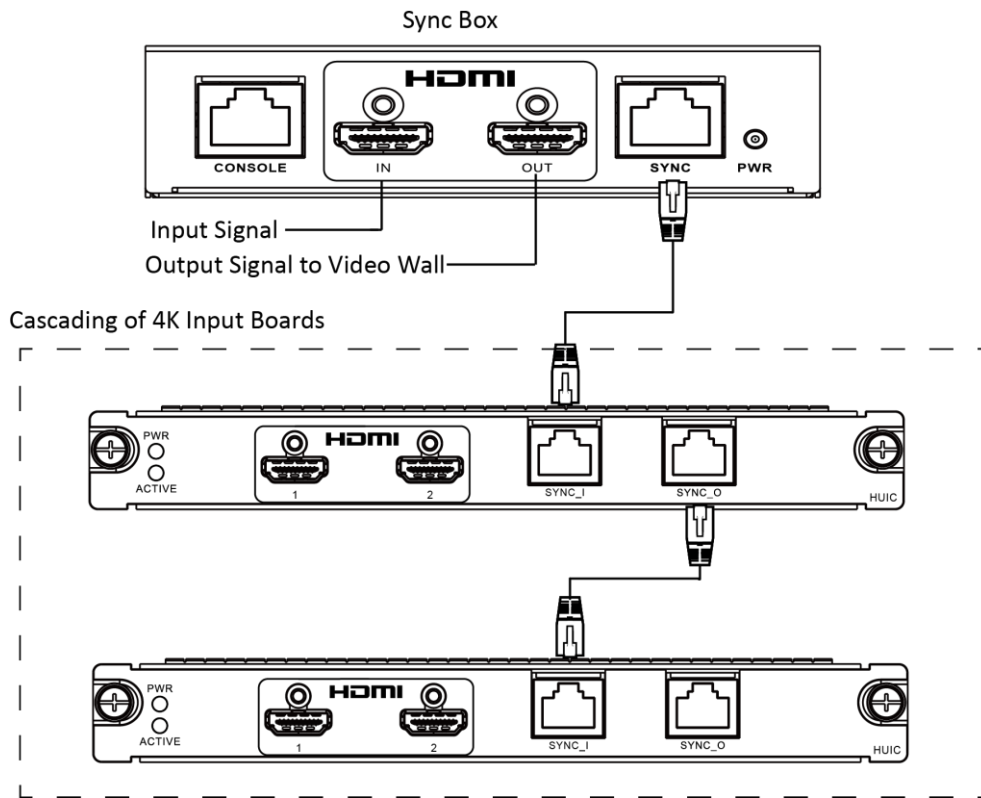

Chapter 2 Accessing via iVMS-4200 Video Wall Client Software

2.1 Software Overview

You can control and manage the DS-C10S-S09T/S11T/S22T video wall controller via the iVMS-4200 video wall client software. It provides multiple functions, including controlling screen, displaying signals on the video wall, playback, managing scene and plan, configuring virtual LED, etc.

2.1.1 Working Environment

- **Operating System:** Microsoft Windows 7/Windows Server 2008 (32/64-bit operating system); Windows Server 2003 or Windows XP (32-bit operating system).
- **CPU:** Intel Pentium IV 3.0 GHz or models above.
- **Memory:** 1G or above.
- **Displayer:** 1024 × 768 or above.



The software does not support 64-bit operating system; the above mentioned 64-bit operating system refers to the system which supports 32-bit applications as well.

2.1.2 Performance

- Up to 256 controllers can be managed.
- Many controllers can be added to the software; however, only one controller can be controlled at a time.
- One controller can be connected by 320 clients at a time.



A higher hardware configuration is needed when viewing multiple channels or HD (High Definition) images.

2.2 Software Installation

2.2.1 Installing the Software

Double-click the setup program to start the InstallShield Wizard. Follow the steps and complete the installation.

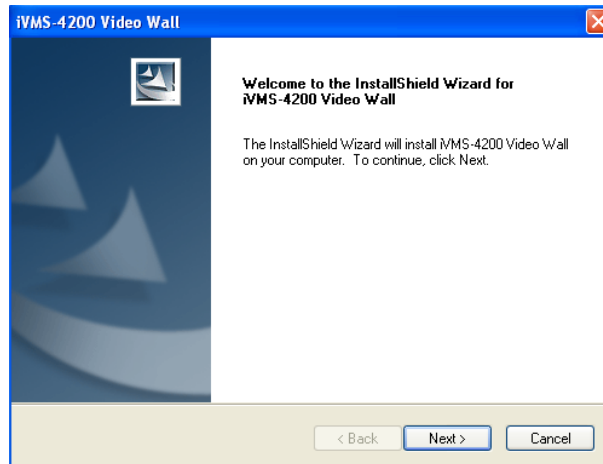

Figure 2-1 Install Software

2.2.2 Uninstalling the Software

Option 1:

Double-click the setup program again to enter the uninstall menu. And follow the prompt to uninstall the software.

Option 2:

Enter Windows Startup Menu and select uninstall iVMS-4200. Then follow the prompt to uninstall the software.

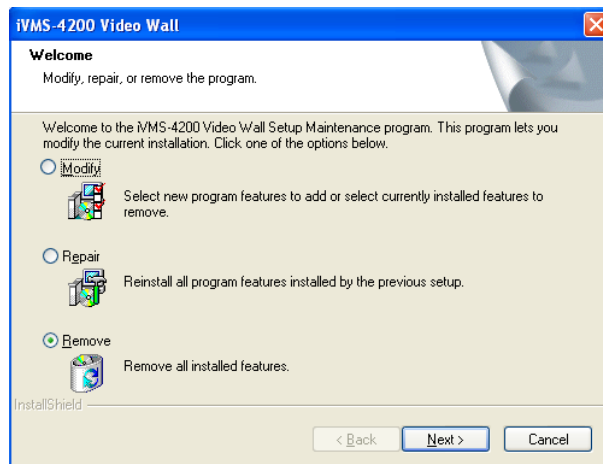

Figure 2-2 Uninstall Software

2.3 User Registration and Login

2.3.1 Registration

Purpose

For the initial application of iVMS-4200 video wall client software, you need to register a super user for login.

- Step 1 Input the User Name, Password and Confirm Password.
- Step 2 (Optional) You can check the checkbox of **Auto-Login** to log in automatically when running software next time.
- Step 3 Click **Register** to save the user and password.

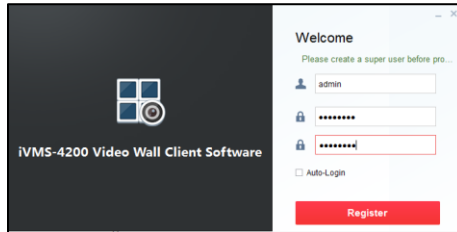

Figure 2-3 Registration

 **NOTE**

- User name and password cannot be empty or contain the following characters: / \ : * ? \ " < > | .
- The valid character of user name includes numbers (0 to 9) and letters (a to z, A to Z).
- The blank character before or after the user name will be automatically deleted.
- The valid length of password for super user ranges from 6 to 16 characters. It is highly recommended to set a password of 8 to 16 characters. The valid length of password for other users should be less than 16 characters.
- Password cannot be copied or pasted.

2.3.2 Login

- Step 1 Input the **User Name** and **Password**.
- Step 2 (Optional) Check the checkbox of **Auto-Login** to log in automatically when running software next time.
- Step 3 Click **Login** to log in.

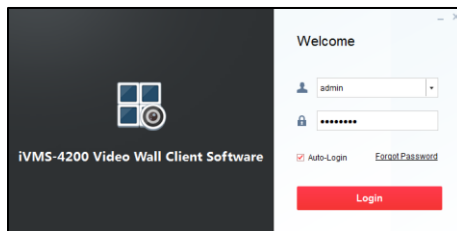

Figure 2-4 Login Interface

2.4 Using the Wizard for Basic Configuration

Purpose

After initial login, the setup wizard pops up automatically. It can walk you through some basic settings of the video wall client software.

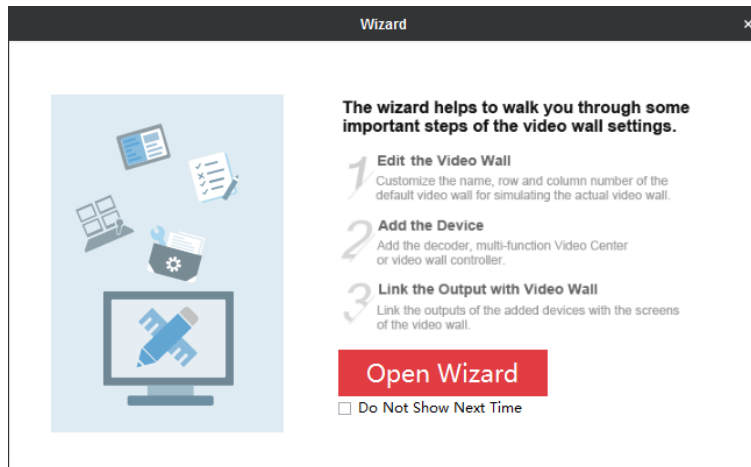

Figure 2-5 Start Wizard

Step 1 Click **Open Wizard** to enter **Add Video Wall** interface.

Step 2 If you don't want to use the setup wizard at the moment, click **X** to exit. You can also use the Setup Wizard next time by leaving the **Do Not Show Next Time** unchecked.

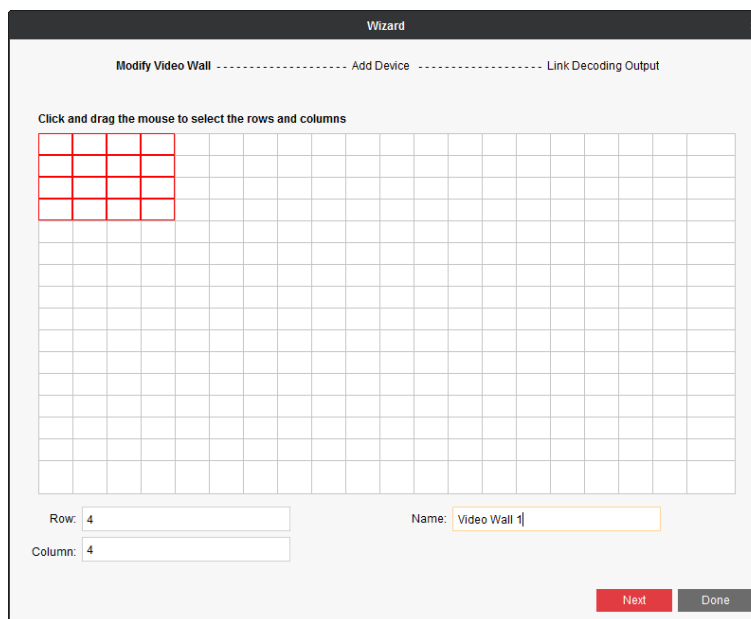

Figure 2-6 Add Video Wall

Step 3 Draw a video wall by dragging the mouse to select the rows and columns, or inputting values in **Row** and **Column** text fields.

Step 4 Input the video wall name in **Name** text field.

Step 5 Click **Next** to save the settings and enter **Add Device** interface.

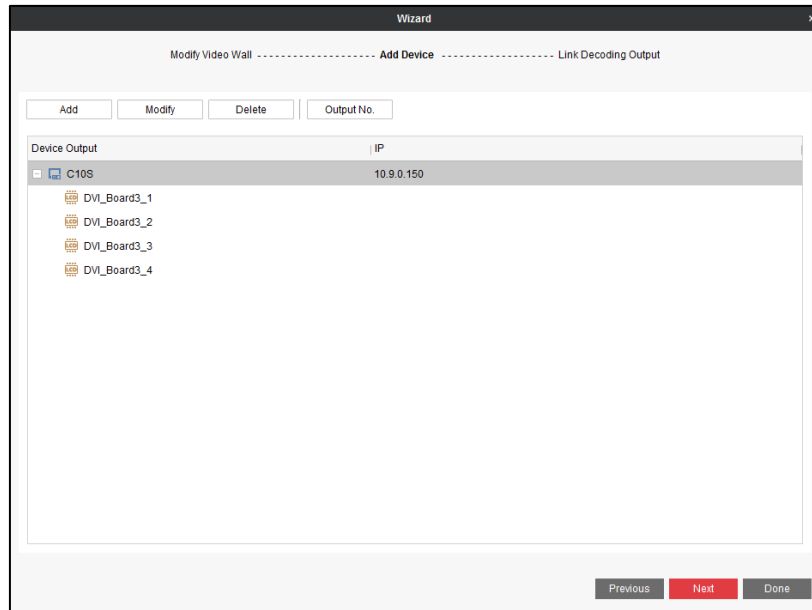

Figure 2-7 Add Device

Step 6 You can add, modify, delete devices and show the output No. here. Three types of devices can be added, including video wall controller, MVC (Multi-Function Video Center), and decoder.

● **Adding a Device**

- 1) Click **Add** to pop up the adding interface.
- 2) Select **Adding Mode** as **IP/Domain** or **IP Segment**. We take adding via IP/Domain as an example.
- 3) Select the **Device Type** to be **Hikvision Device** or **Third-Party Device**.
- 4) Input **Nickname**, **Address**, **Port**, **User Name**, and **Password** in the text fields.
- 5) Click **Add** to add the device(s).

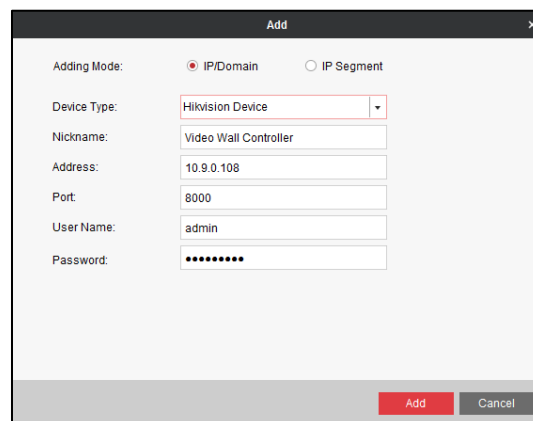

Figure 2-8 Add a Device

● **Modifying the Added Device**

- 1) Select the added device and click **Modify** to enter the **Modify** interface.

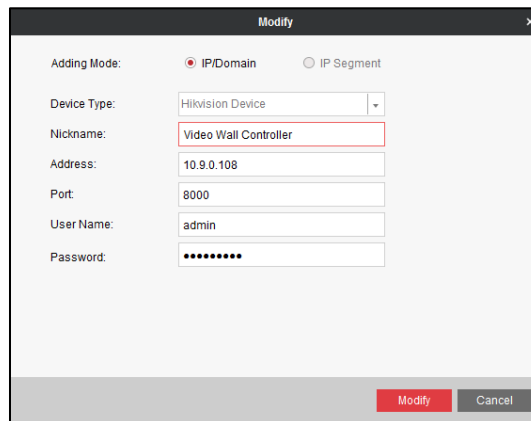

Figure 2-9 Modify the Added Device

- 2) Edit the **Nickname**, **Address**, **Port**, **User Name**, and **Password** to modify the parameters.
- 3) Click **Modify** to save the settings.

- **Deleting a Device**

- 1) Select an added device.
- 2) Click **Delete** to delete it.

- **Showing Output No.**

- 1) Click **Output No.**
- 2) Select the device(s) you need to display the output No.
- 3) Click **Show** to enable the function. Thus the output No. of the selected device(s) will be shown on the video wall.

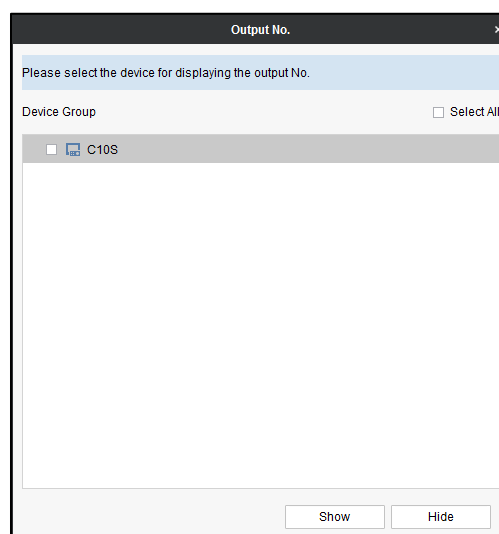

Figure 2-10 Show Output No.

Step 7 After the devices are configured, click **Next** to enter **Link Decoding Output** settings interface.

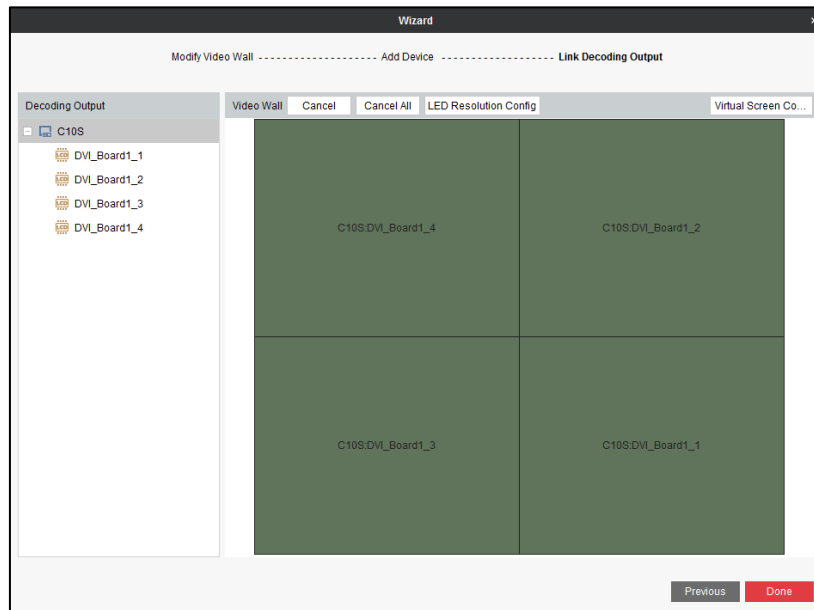

Figure 2-11 Link Decoding Output

Step 8 You can adjust the output window of the added video wall controller, add or delete virtual screen for the selected output window, and configure the LED output resolution.

- **Adjusting the Output Window**

- 1) Click **Cancel All** to clear the default settings. Or select a window and click **Cancel** to clear the linkage between the output and the window.
- 2) Drag a decoding output in the Decoding Output list to a window to link the output to the window.
- 3) Repeat the above steps to configure other outputs.

- **Adding Virtual Screen**

- 1) Click **Virtual Screen Config** to expand the **Virtual Screen Configuration** menu.

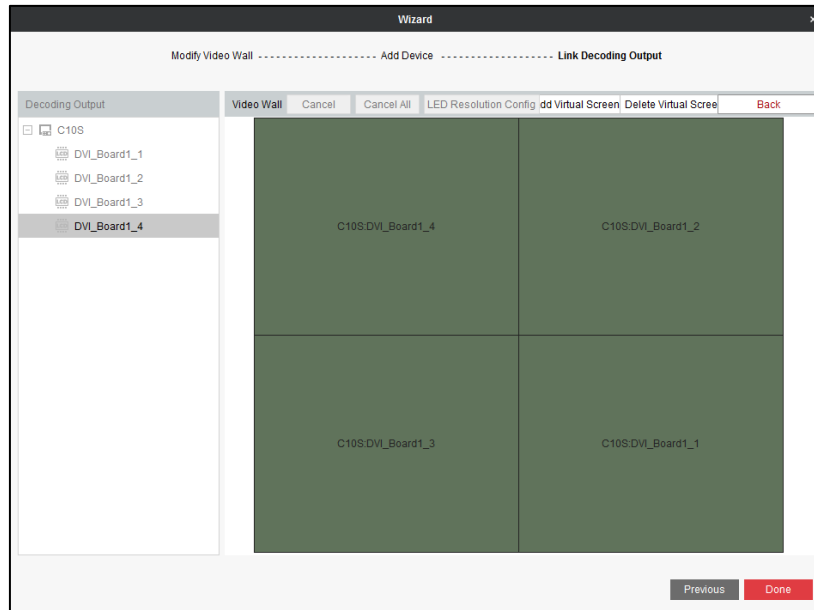

Figure 2-12 Configure Virtual Screen

- 2) Select the output area you want to add virtual screen.
- 3) Click **Add Virtual Screen** to enter the interface.
- 4) Select a **Virtual Screen Mode** and input the parameters.
- 5) Click **OK** to save the settings.

● **Deleting Virtual Screen**

- 1) Drag the mouse to select the configured virtual screen area.
- 2) Click **Delete Virtual Screen** to delete it.

● **Configuring LED Resolution**

- 1) Click **Back** to return to the Link Decoding Output interface.
- 2) Select the LED area and click **LED Resolution Config** to configure the LED resolution.
- 3) Input the **LED Resolution** and click **OK** to save the settings.

Step 9 Click **Done** to save the settings.

2.5 Graphical User Interface Introduction

Refer to Figure 2-13 and Table 2-1 for the introduction of the graphical user interface (GUI) of iVMS-4200 Video Wall Client Software.

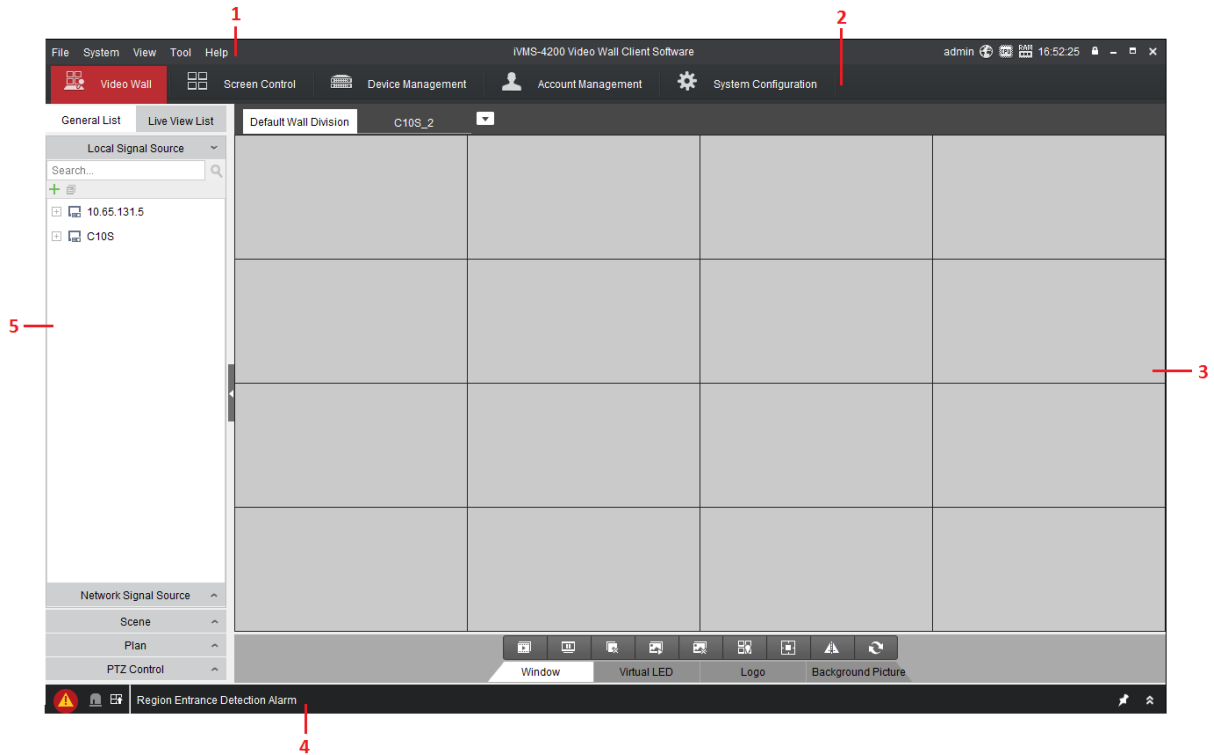

Figure 2-13 Software Interface

Table 2-1 Description of the GUI

No.	Name	Description of the GUI
1	Menu Bar	Menu includes File, System, View, Tool, and Help.
2	Quick Launch Bar	Video Wall, Screen Control, Device Management, Account Management, and System Configuration.
3	Maintenance and Management Area	Configure and manage the video wall controller and the software.
4	Notification Bar	Display information of the current window and live view; view alarm information.
5	Configuration List	Manage Local Signal Source, Network Signal Source, Scene, Plan and PTZ.
No.	Name	Description of Menu Bar
1	File	Open log files saved in the computer.
2	System	Lock software, switch user, and import/export system configuration files.
3	View	Enter Video Wall, Screen Control, Device Management, Account Management, and System Configuration

		interface.
4	Tool	Enter Log Search, Video Wall Linkage, and Device Arming Control interface.
5	Help	Open video wall wizard, open user manual, view software version, and switch language.

Chapter 3 Configuring Controller via the Software

3.1 Video Wall Introduction

Click **Video Wall** in the Quick Launch Bar to enter **Video Wall** interface. For detailed configuration, you can refer to *Chapter 4 Managing Video Wall*.

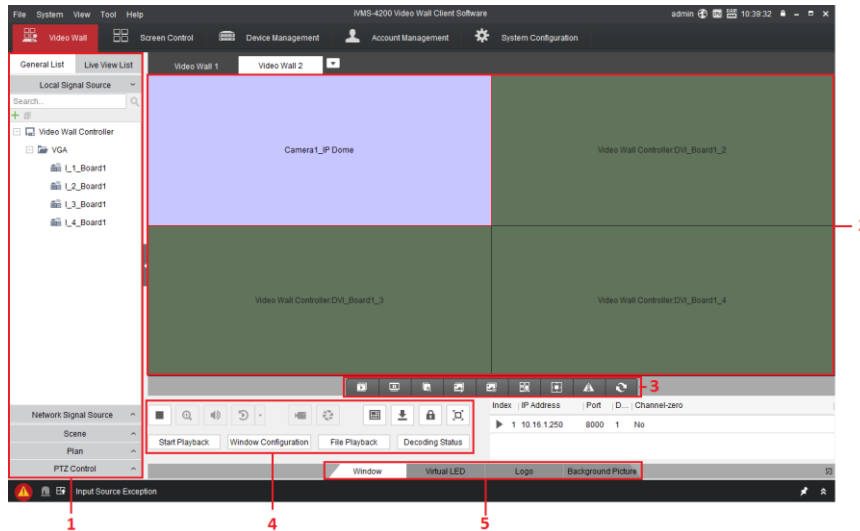

Figure 3-1 Video Wall Interface

Refer to Table 3-1 for the description of video wall.

Table 3-1 Video Wall Description

Region	Name	Description
1	Menu List	Manage Local Signal Source, Network Signal Source, Scene, Plan and PTZ.
2	Window Management Area	Open/close windows and move windows.
3	Window Management Toolbar	Start/stop live view of all the roaming windows, start/stop decoding all signal sources and cameras, close/open windows, start/stop VCA decoding for all signal sources and cameras, open window via coordinate, enable/disable video wall mirror, and refresh live view screens.
4	Advanced Settings Area	Settings area for advanced parameters.
5	Advanced Settings	Configure Window, Virtual LED, Logo and

	Menu	Background Picture.
--	------	---------------------

Refer to Figure 3-2 and Table 3-2 for the description of window management toolbar.



Figure 3-2 Window Management Toolbar

Table 3-2 Window Management Toolbar Description

Icon	Name	Description
	Start/Stop Live View	Start/Stop live view of all the roaming windows.
	Start/Stop All Decoding	Start/Stop decoding all signal sources and cameras.
	Close All Windows	Close all the windows displayed on the video wall.
	Start All VCA Decoding	Start VCA decoding for all live view signals. Once it is started, the VCA information can be viewed in live view.
	Stop All VCA Decoding	Stop VCA decoding for all live view signals.
	Open Window	Draw a window according to your need. The size and position of the window are adjustable.
	Open Window via Coordinate	Open a window by inputting X-coordinate, Y-coordinate, width and height. NOTE For the detail operations, refer to <i>Chapter 5.2.4 Opening the Window via Coordinate</i> .
	Show Window No.	Show the window number on the upper left corner of the window.
	Enable/Disable Video Wall Mirror	Enable/Disable video wall mirror. NOTE For the detail operations, refer to <i>Chapter 4.3.1 Mirroring Video Wall</i> .
	Refresh	Refresh the video wall status.

Refer to Figure 3-3 and Table 3-3 for the description of advanced settings menu.



Figure 3-3 Advanced Settings Menu

Table 3-3 Advanced Settings Menu Description

Name	Description
Window	Advanced settings for windows.
Virtual LED	Enable/disable virtual LED and edit virtual LED content.
Logo	Reserved function. Not supported by video wall controller.
Background Picture	Upload and enable/disable background picture.

3.2 Managing Video Wall Controller

3.2.1 Activating the Video Wall Controller

Purpose

You are required to activate the video wall controller first by setting a strong password before using.

Before you start

Ensure your computer is in the same network segment with the controller.

- Step 1 Select **Device Management** in the Quick Launch Bar to enter Device Management interface.
- Step 2 Select an inactive device and click **Activate** to enter Activation interface.

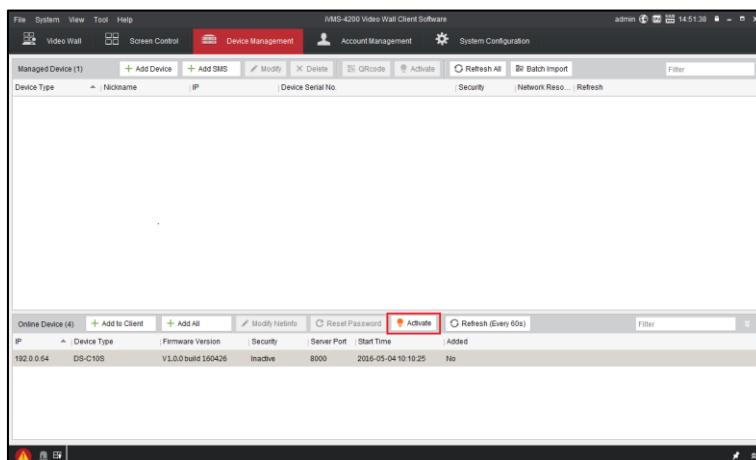

Figure 3-1 Device Management

Step 3 Input the password and confirm it.

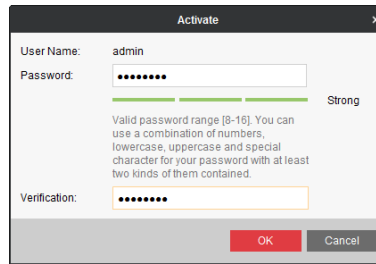

Figure 3-2 Activate the Video Wall Controller



WARNING

STRONG PASSWORD RECOMMENDED—We highly recommend you create a strong password of your own choosing (Using a minimum of 8 characters, including at least three of the following categories: upper case letters, lower case letters, numbers, and special characters.) in order to increase the security of your product. And we recommend you reset your password regularly, especially in the high security system, resetting the password monthly or weekly can better protect your product.

Step 4 Click **OK** to save the password and activate the controller.

3.2.2 Adding the Video Wall Controller

Step 1 Select the activated controller and click **Modify Netinfo** to set the IP address of the controller.

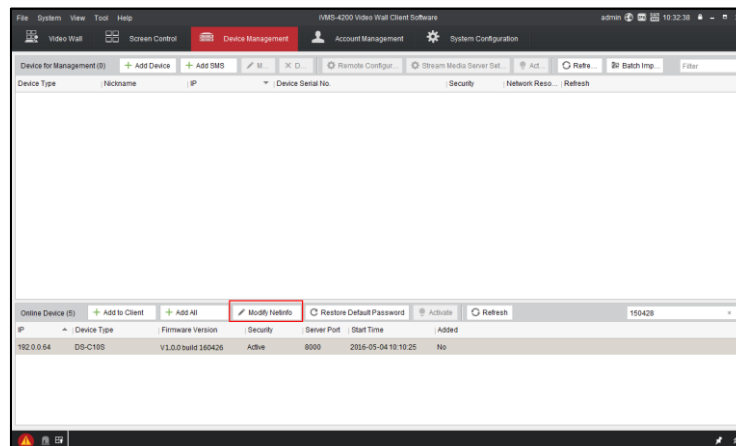

Figure 3-3 Device Management

Step 2 Input the **IP Address**, **Gateway** and **Password**, and click **OK** to save the settings.

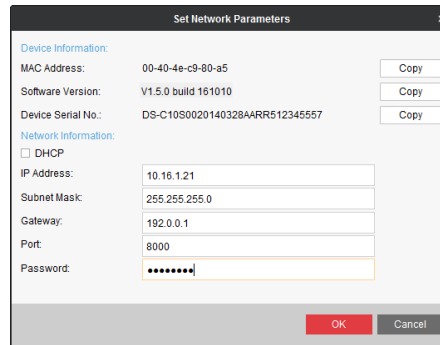

Figure 3-4 Set Network Parameters

Step 3 Click the **Add to Client** button and input the **Nickname, Address, User Name** and **Password** for the controller.

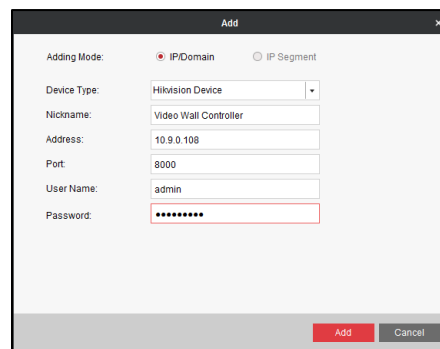

Figure 3-5 Add the Video Wall Controller

 **WARNING**

STRONG PASSWORD RECOMMENDED—We highly recommend you create a strong password of your own choosing (Using a minimum of 8 characters, including at least three of the following categories: upper case letters, lower case letters, numbers, and special characters.) in order to increase the security of your product. And we recommend you reset your password regularly, especially in the high security system, resetting the password monthly or weekly can better protect your product.

Step 4 Click **Add** to add it.

3.3 Configuring Remote Settings

Purpose

In the remote configuration interface, the parameters of the added controller, including the system, network, etc., can be set.

Select an added controller and click **Remote Configuration** to enter **Remote Configuration** interface.

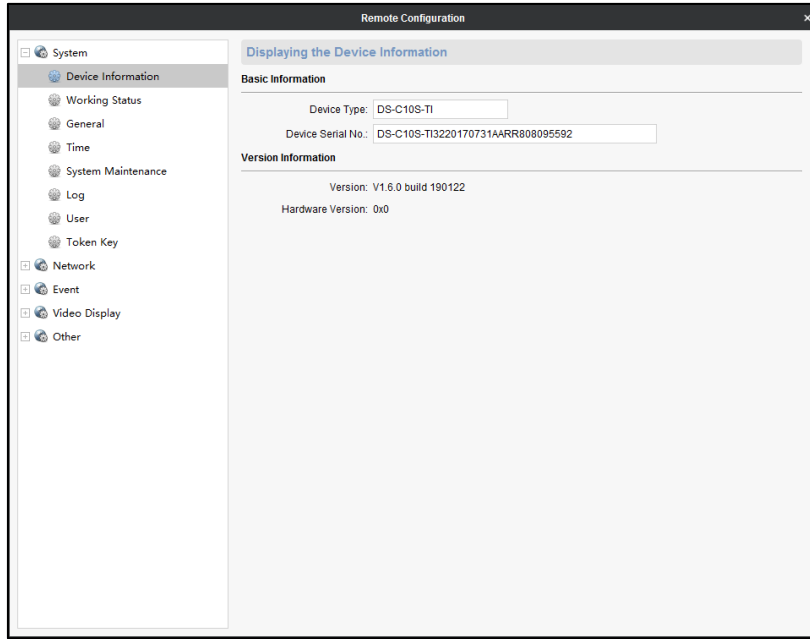

Figure 3-6 Remote Configuration Interface

Refer to Table 3-4 for the description of remote configuration.

Table 3-4 Description of Remote Configuration

Parameters	Description
System	View device information and status, configure general parameters and users, manage device, set time, search and backup logs.
Network	Configure general network parameters.
Event	Configure exception linkage method.
Video Display	Upload background picture, configure video parameters of input signal, adjust picture position, configure background color, configure the input signal resolution and configure OSD.
Others	Bind the screen server, configure the decoding device parameters, configure the matrix linkage parameters, collage the signal source and configure the motherboard serial port parameters.

3.3.1 Configuring System Settings

You can configure the parameters listed in Table 3-5 for the system settings. Here we take the working status configuration as an example.

Table 3-5 Description of System

Parameters	Description
Device Information	View basic information and version.
Working Status	Display the status of the controller, sub-boards, and fans.
General	Configure device name.
Time	Configure time zone, NTP and DST parameters.
System Maintenance	System management and remote upgrade.
Log	Search and backup device logs.
User	<p>Add operators and specify permissions.</p> <p> NOTE</p> <p>Up to 32 users can be added. The admin can add, modify and delete other operators. Operators can only modify parameters of their own.</p>

Viewing Working Status

Purpose

You can view the device running status such as CPU usage, memory usage, backboard temperature, host temperature, sub-board temperature, sub-board status, and fan status.

Step 1 Go to **System > Working Status**.

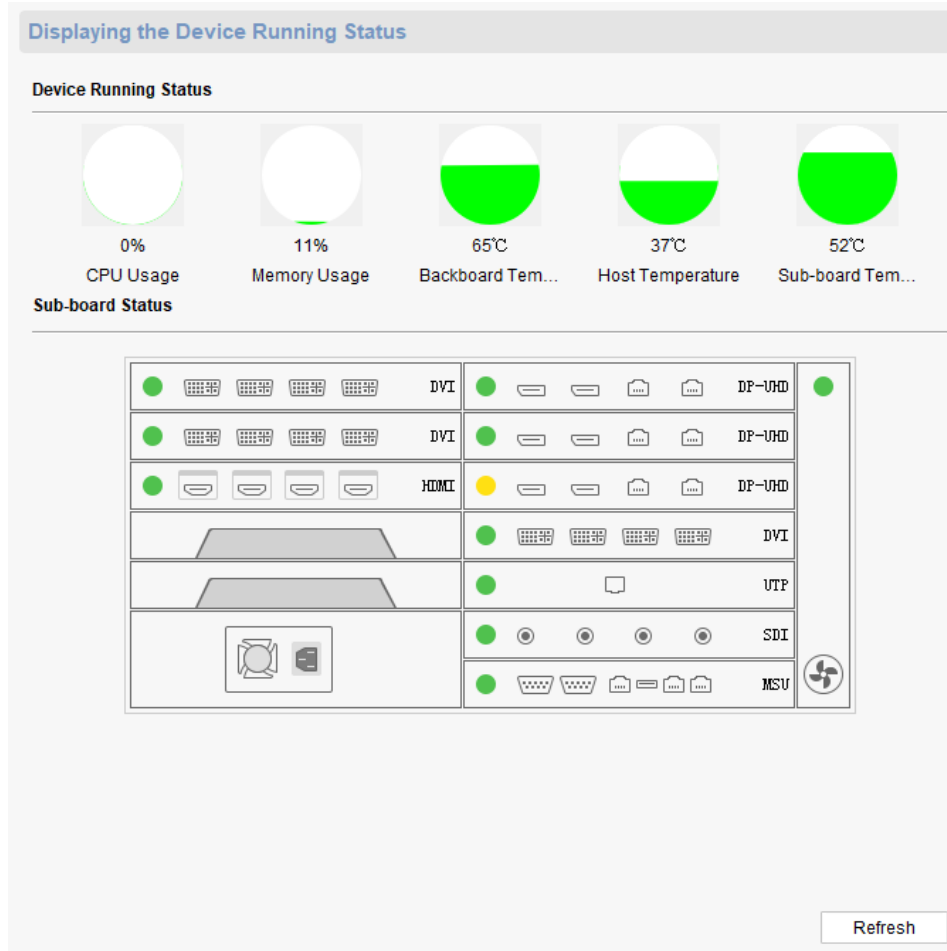





Figure 3-7 Working Status



Step 2 View the device running status.

You can view the CPU usage, memory usage, backboard temperature, host temperature, and sub-board temperature.

Step 3 View the sub-board status.

-  : It means the status is normal.
-  : It means the status is abnormal. Move the cursor to the red indicator and you can view the exception information.
-  : It means the 4K HDMI input boards or 4K DP input boards are not synchronized.

Step 4 View the fan status.

-  : It means the fan is working normally. The number on the lower right corner of the icon shows the rotating speed of the fan.
-  : It means the rotating speed of the fan is abnormal.
-  : It means there is communication exception of the fan.

Step 5 (Optional) Click **Refresh** to refresh the status.

3.3.2 Configuring Network Settings

Step 1 Click **Network** tab.

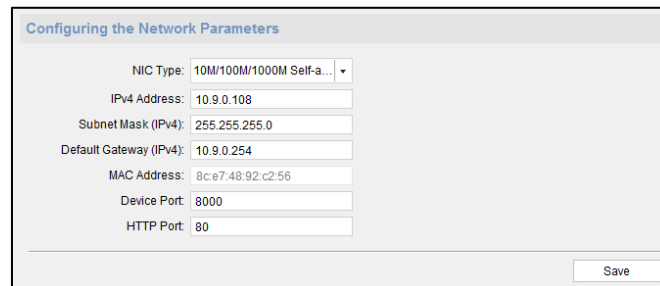

The screenshot shows a web interface titled "Configuring the Network Parameters". It contains several input fields: "NIC Type" is a dropdown menu showing "10M/100M/1000M Self-a..."; "IPv4 Address" is "10.9.0.108"; "Subnet Mask (IPv4)" is "255.255.255.0"; "Default Gateway (IPv4)" is "10.9.0.254"; "MAC Address" is "8c:e7:48:92:c2:56"; "Device Port" is "8000"; and "HTTP Port" is "80". A "Save" button is located at the bottom right.

Figure 3-8 Network Configuration Interface

Step 2 Select **NIC Type** from the dropdown list.

Step 3 Input **IPv4 Address**, **Subnet Mask** and **Default Gateway**.

Step 4 Click **Save** to save the settings.

3.3.3 Configuring Event Settings

Step 1 Click **Event** tab.

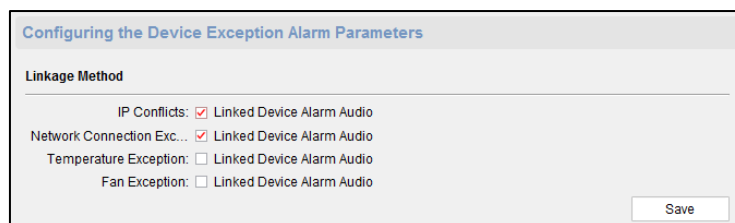

The screenshot shows a web interface titled "Configuring the Device Exception Alarm Parameters". Under the "Linkage Method" section, there are four items with checkboxes: "IP Conflicts" (checked), "Network Connection Exc..." (checked), "Temperature Exception" (unchecked), and "Fan Exception" (unchecked). All checked items are linked to "Linked Device Alarm Audio". A "Save" button is at the bottom right.

Figure 3-9 Event Configuration Interface

Step 2 Enable **Linked Device Alarm Audio** by checking the corresponding checkbox.

Step 3 Click **Save** to save the settings.

3.3.4 Configuring Video Display Settings

Step 1 Click **Video Display** tab.

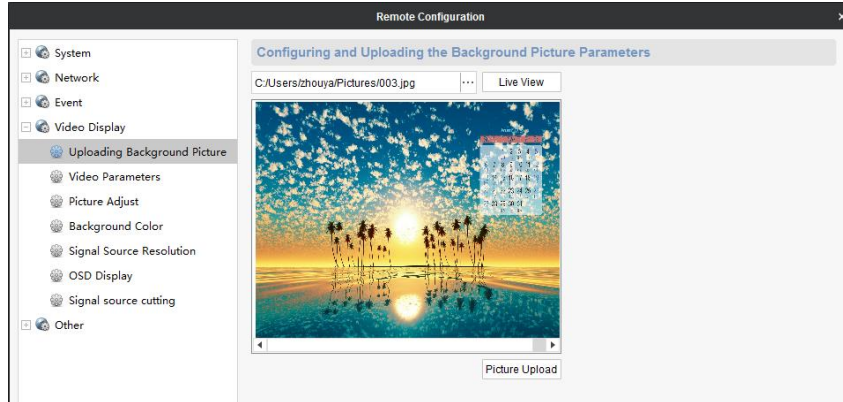

Figure 3-10 Video Display Configuration Interface

Step 2 Click **Background Picture**, **Video Parameters**, **Picture Adjustment**, **Background Color**, **Signal Resolution**, or **OSD** to configure corresponding parameters. For details, refer to Table 3-6 below.

Table 3-6 Description of Video Display Settings

Parameters	Description
Background Picture	Upload local picture as the background of output screen.
Video Parameters	Adjust the video parameters of input signal.
Picture Adjust	Adjust the position of input signal.
Background Color	Set the background color of output.
Signal Source Resolution	Set the signal resolution and refreshing frequency. For detailed steps, refer to <i>Configuring Signal Resolution</i> .
OSD Display	Set the on-screen-display parameters. For detailed steps, refer to <i>Configuring OSD</i> .
Signal Source Cutting	Cut top, bottom, left or right of the selected picture.

Configuring Signal Resolution

Purpose

You can configure the resolution of the input signals.

Step 1 Click **Signal Source Resolution** to enter the Signal Resolution Configuration interface.

The screenshot shows a web interface titled "Configuring Custom Resolution". It contains the following elements:

- Enable Resolution:** A checkbox labeled "Enable" which is currently unchecked.
- Signal Source Name:** A dropdown menu with "L_1_Board4" selected.
- Refresh Frequency:** A dropdown menu with "25" selected.
- Resolution:** Two text input fields for width and height, both containing the number "0".
- Batch Configuration:** A checked checkbox.
- copy to:** A section with expandable checkboxes for "HDMI" (checked) and "DP" (unchecked).
- Save:** A button at the bottom of the form.

Figure 3-11 Configure Input Signal Resolution

- Step 2 Select the input signal from the **Signal Source Name** dropdown list.
- Step 3 Check the checkbox of **Enable Resolution** to enable the custom signal resolution.
- Step 4 Set the **Refresh Frequency**.
- Step 5 Input the resolution in the **Resolution** text fields.
- Step 6 If you want to copy the same configuration to other input signals, check the checkbox of **Batch Configuration**, and click  to expand the signal input list and check the corresponding checkbox(es) to select the input signal(s).
- Step 7 Click **Save** to save the settings.

 **NOTE**

- The resolution cannot exceed the maximum resolution supported by the signal source. If the resolution exceeds 1920 × 1200, the maximum refreshing frequency can only be set to 30.
- The DVI, HDMI, and DP input interfaces support custom resolution configuration. If interfaces of other types are connected, it will remind that the transmitted data error.
- For the HDMI 4K interface, the max. resolution is 3840 × 2160, and the min. resolution is 1280 × 720.

- Step 8 Change the display resolution of your computer. Refer to *Chapter 4.8 Setting the Custom Resolution on the Computer* for reference.

Configuring OSD

Purpose

You can configure the OSD (On Screen Display) of the input signal.

 **NOTE**

The OSD configuration is supported for the DVI, HDMI and DP signal inputs of DS-C10S-SXXT series video wall controller.

Step 1 Click **OSD Display** to enter the OSD Configuration interface.

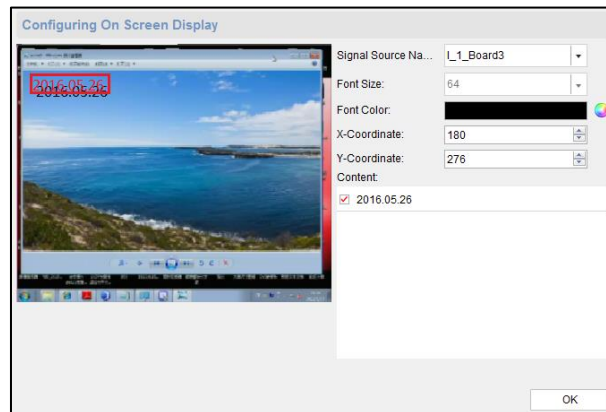



Figure 3-12 Configure OSD

Step 2 Select the input signal from the **Signal Name** dropdown list.

Step 3 The **Font Size** cannot be configured and the default size is 64.

Step 4 Click  to select the **Font Color**. Or you can set the custom color. Click **OK** to save the font color.

Step 5 Click the field after the **Content** checkbox to edit the information you want to show on the OSD. Up to 24 English characters can be edited.

Step 6 Check the checkbox of **Content** to show the edited information on the OSD or uncheck it to hide it.

Step 7 Click  to adjust the **X-Coordinate** and **Y-Coordinate** or you can input the numbers in the text fields. Or you can drag the textbox on the left window to adjust its position.

Step 8 Click **OK** to save the settings.

3.3.5 Configuring Other Settings

Step 1 Click **Others** tab.

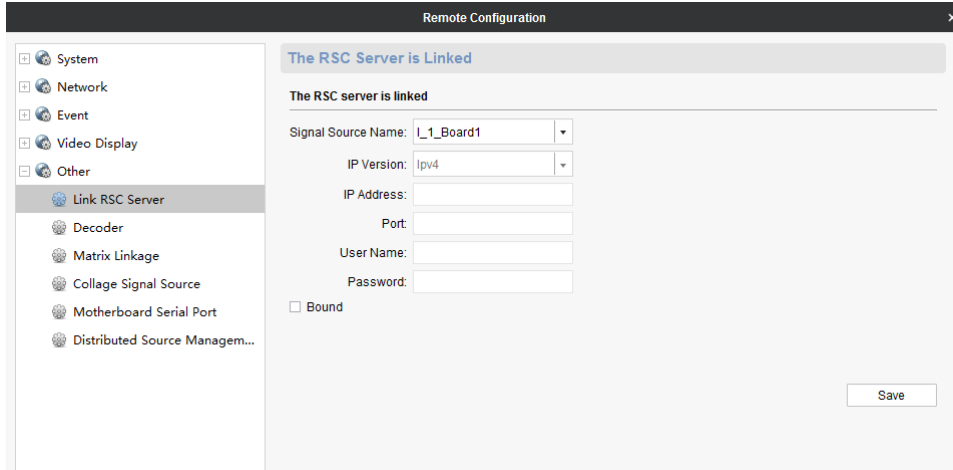





Figure 3-13 Others Configuration Interface

Step 2 Select the tab such as **Screen Controller Server Bind, Decoding Board, Matrix Linkage, Signal Source Collage, Motherboard Serial Port, or Distributed Source Management**. For details, please refer to *Table 3-7 Description of Other Settings*.

Table 3-7 Description of Other Settings

Parameters	Description
Link Server RSC	<p>Bind the input signal with the screen controller server.</p> <p> NOTE</p> <p>Only when the screen server is installed and enabled on the computer with configured signal source, can the screen controller server be bound in the remote configuration.</p> <p>After the screen controller server is bound, you can control the computer installed with it by right-clicking the remote interaction of the video wall window via the client, such as opening the document, PowerPoint and video.</p>
Decoder	<p>Configure the general network parameters of decoding board and view decoding board status.</p> <p> NOTE</p> <p>Decoding board needs be independently connected to network. And it does not decode the stream with frame rate below 1 fps.</p>
Matrix Linkage	<p>Add, edit and delete linked matrix. The channels of added matrix will be listed in signal sources of video wall interface and you can display it on video wall. For detailed operations, refer to <i>Linking Matrix</i>.</p>

	 NOTE Before displaying the matrix signal sources, you need to do following operations. Connect the COM 2 of motherboard to the COM port of matrix. Configure the board function of motherboard as matrix control.
Signal Source Collage	Collage several signal sources into one. For detailed operations, refer to <i>Collaging Signal Sources</i> .
Motherboard Serial Port	Configure the parameters of motherboard serial port.  NOTE The Board Function can to be set as Matrix Control, Screen Control or Keyboard Control according to the serial port usage.
Distributed Source Management	Add, modify and delete the distributed network sources. For detailed operations, refer to <i>Managing Distributed Sources</i> .

Linking Matrix

Purpose

You can add, modify and delete the linked matrix in matrix linkage configuration.

Step 1 Click **Matrix Linkage** tab to enter the Matrix Linkage Configuration interface.

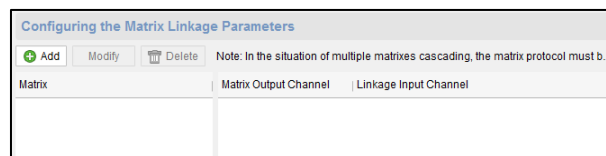

Figure 3-14 Configure Matrix Linkage

Step 2 Click **Add** to add the matrix.

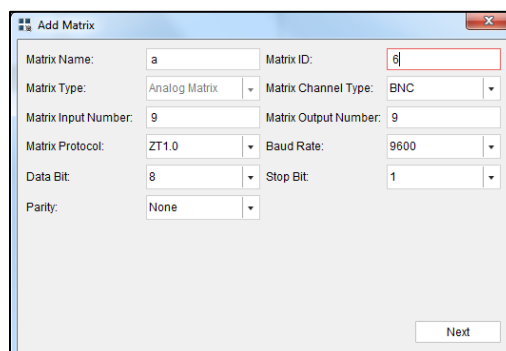



Figure 3-15 Add Matrix

Step 3 Input the **Matrix Name**, **Matrix ID** (custom), **Matrix Input Number** and **Matrix Output Number**. Select the **Matrix Channel Type**, **Matrix Protocol**, **Baud Rate**, **Data Bit**, **Stop Bit** and **Parity**.

 **NOTE**

- Matrix protocol of ZT1.0, ZT2.0, Extron, Creator and HIK_CVBS_96P are supported.
- Up to 4 matrixes can be connected. If the matrix protocol is HIK_CVBS_96P, up to 512 X 512 input channels of each matrix are supported. If the matrix protocol is others, up to 512 X 128 input channels of each matrix are supported.

Step 4 Click **Next** to link the input channel with the matrix output channel.

- 1) Click  to select the input channel to link with the matrix output channel.
- 2) Click **Save** to save the settings.

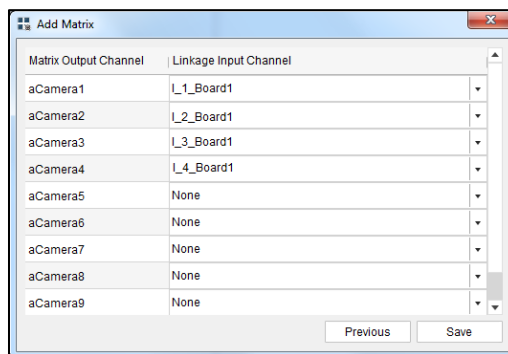

Figure 3-16 Link Input Channel

Step 5 On the Device Management interface, click  to refresh the controller.

Step 6 (Optional) You can click **Modify** or **Delete** on the **Matrix Linkage** interface to modify or delete the linked matrix.

 **NOTE**

After the matrix configuration, enter the **Video Wall** interface. The input channels of the linked matrix will be listed in the Local Signal Source list. You can drag one input channel of the linked matrix to the video wall as shown below.

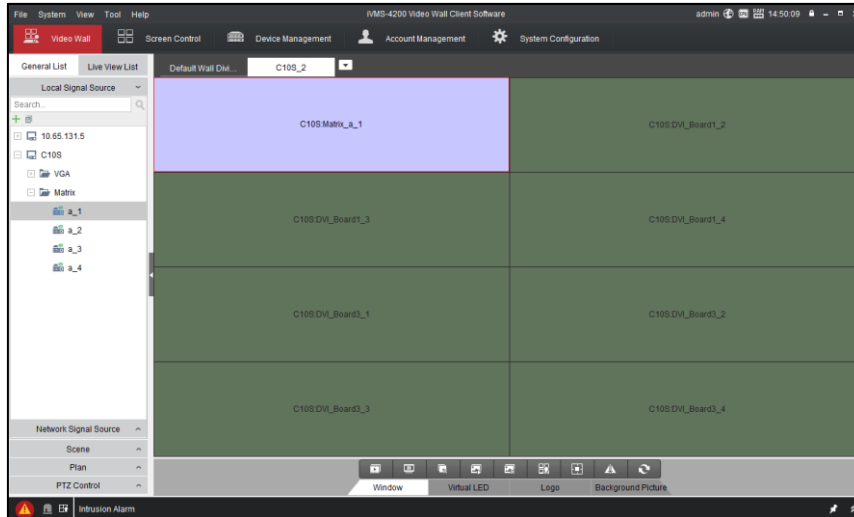

Step 7 Display Matrix Input Channel to the Video Wall

Collaging Signal Sources

Purpose

You can collage several signal sources into one.

Step 1 Click **Signal Source Collage** to enter Signal Source Collage interface.

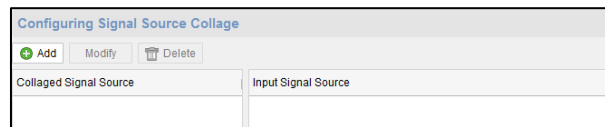

Figure 3-17 Collage Signal Source

Step 2 Click **Add** to add collaged signal source.

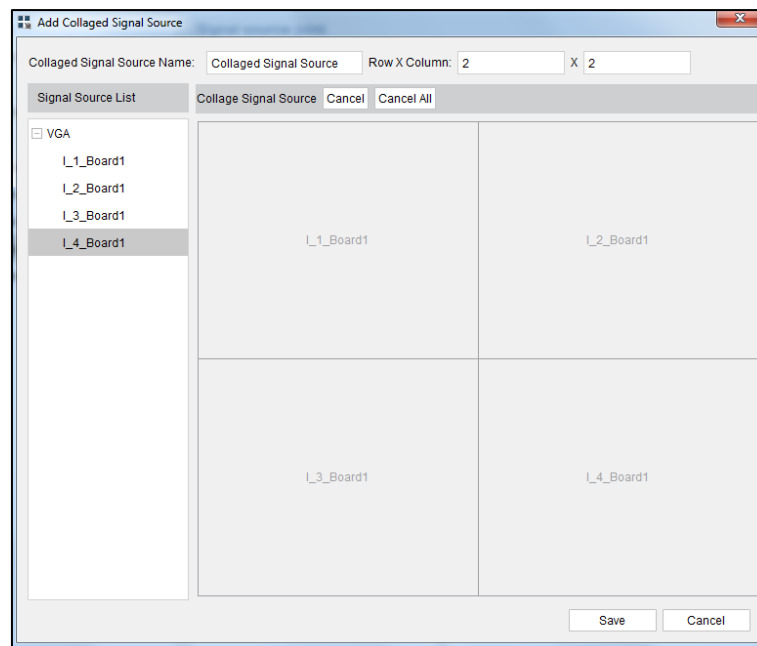

Figure 3-18 Add Collaged Signal Source

Step 3 Input the **Collaged Signal Source Name**, and input the **Row** and **Column** in the corresponding text fields.

Step 4 Drag signal sources needed to be collaged into the windows.

 **NOTE**

- Only the local signal sources can be collaged.
- A maximum of 16 signal sources can be collaged.
- Ensure each window links one signal source.

Step 5 Click **Save** to save the settings.

Step 6 (Optional) You can also select a window and click **Cancel** to cancel collaging the selected signal source or click **Cancel All** to cancel all the collaged signal sources.

Step 7 Return to the **Signal Source Collage** interface. Select the added collaged signal source and the input signal sources included in the collaged signal source will be displayed.

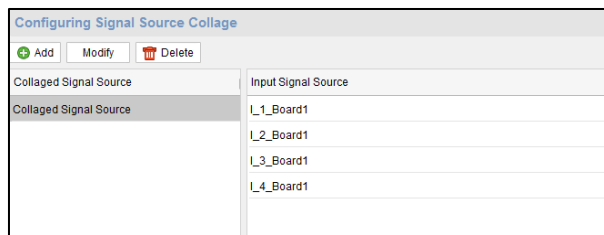

Figure 3-19 Collaged Signal Source

Step 8 (Optional) Select the added collaged signal source and click **Modify** to modify it.

Step 9 (Optional) Select the added collaged signal source and click **Delete** to delete it.

Step 10 Enter the **Video Wall** interface and the collaged signal source will be listed in the Local Signal Source list. Drag it to display on the video wall.

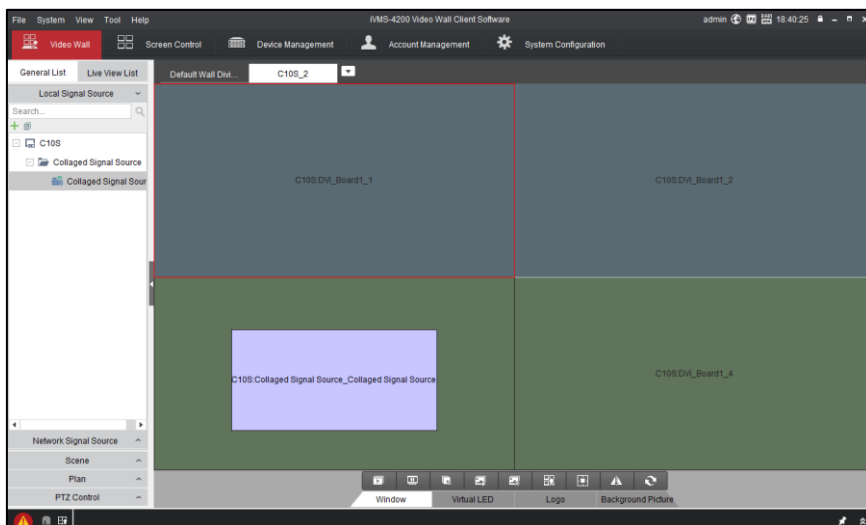

Figure 3-20 Display Collaged Signal Source on the Video Wall

 **NOTE**

- When dragging the collaged signal source to the video wall, it will be displayed together in a single window.
- When roaming or zooming in or zooming out the collaged signal source window, each signal source in it will be roamed or zoomed in or zoomed out.

Managing Distributed Sources

Purpose

You can manage the distributed network sources to raise the signal source capacity and transmission distance.

Step 1 Click **Distributed Source Management** tab to enter the Distributed Source Management interface.

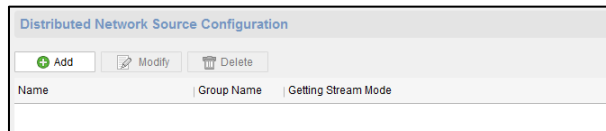

Figure 3-21 Manage Distributed Sources

Step 2 Click **Add** to enter the Distributed Network Source Configuration interface.

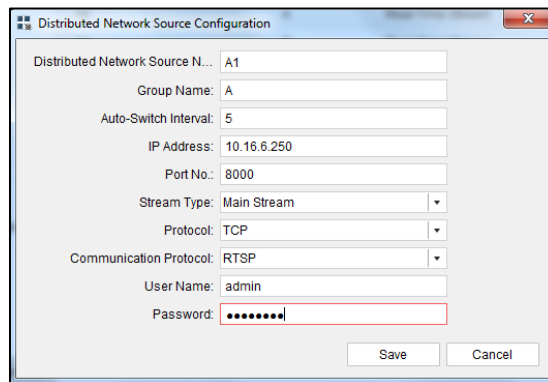

Figure 3-22 Distributed Network Source Configuration

Step 3 Input the **Distributed Network Source Name** (custom), **Group Name** (custom), **Auto-Switch Interval**, **IP Address**, **Port No.**, **User Name** and **Password** of the supported encoder, and select the **Stream Type**, **Protocol** and **Communication Protocol** of the distributed network source.

 **NOTE**

- The auto-switch interval ranges from 1 to 65535.
- The supported devices for distributed network source configuration are DS-6701HFHI/V and DS-6708HWI encoders. For the two series of encoders, the supported resolutions are shown in the following table.

Table 3-8 Supported Resolution of the Encoders

Model	Supported Resolution
DS-6701HFHI/V	VGA: UXGA (1600 × 1200)p60, 1080p60, 1080p50, SXGA (1280 × 1024)p60, 1440 × 900p60, 1366 × 768p60, 720p60, XGA (1024 × 768)p75, XGA (1024 × 768)p60, 800 × 600p60, 640 × 480p60 HDMI: UXGA (1600 × 1200)p60, 1080p60, SXGA (1280 × 1024)p60, 720p60, XGA (1024 × 768)p60
DS-6708HWI	WD1/4CIF/2CIF/CIF/QCIF

Step 4 Click **Save** to save the settings.

Then you can view the added distributed network source list as below.

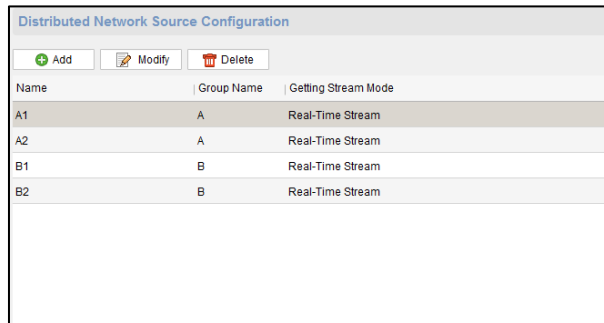

Figure 3-23 Added Distributed Network Source List

Step 5 (Optional) Select an added distributed network source and click **Modify** to modify the parameters, or click **Delete** to delete it.

Step 6 Drag the added distributed network source from the Network Signal Source List on the **Video Wall** interface to display it on the video wall as shown below.

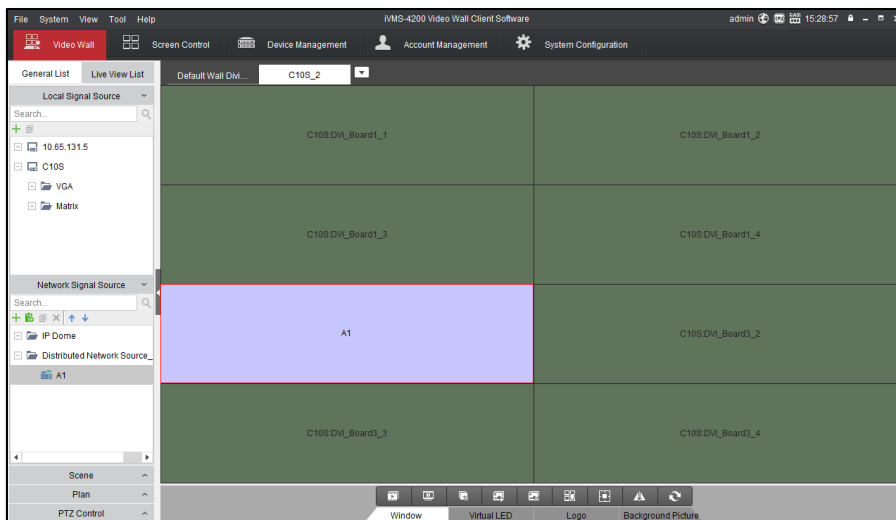

Figure 3-24 Display Distributed Signal Sources

3.4 Screen Control

Purpose

In the **Screen Control** interface, you can set to turn on or off the monitors, and you can also configure the screen color and image position.



NOTE

You are not recommended to configure the screen control without professional instructions.

Before you start

Connect the COM of screen to the COM2 of motherboard of video wall controller.

Step 1 Click **Screen Control** in Quick Launch Bar to enter **Screen Control** interface.

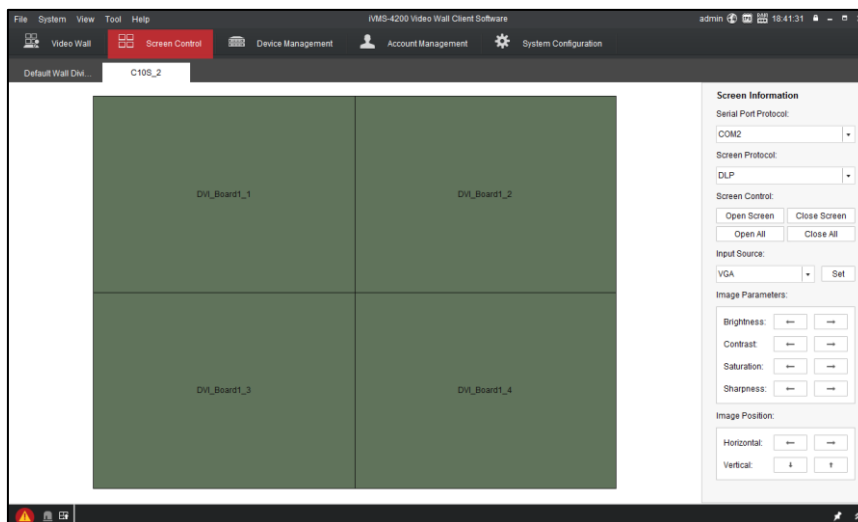

Figure 3-25 Screen Control Interface

Step 2 Drag to select a single window or multiple windows.

Step 3 Select **Serial Port Protocol** as **COM 2**. Thus to specify transmitting port of screen control command.

Step 4 Select **Screen Protocol** and **Input Source** according to actual cord connection.

Step 5 Click **Set** to save the above settings.

Step 6 Adjust **Image Parameters** by clicking or .

Step 7 Adjust **Horizontal Image Position** by clicking or and adjust **Vertical Image Position** by clicking or .

Step 8 Click **Open Screen** or **Close Screen** to turn on/off the screen. Or click **Open All** or **Close All** to turn on/off all the screens.

3.5 Managing User Accounts

Purpose

In default situation, there will be only one super user, registered when logging in. Besides the super user, you can add 49 users, including administrators and operators, with different permissions.

Step 1 Click **Account Management** in the Quick Launch Bar.

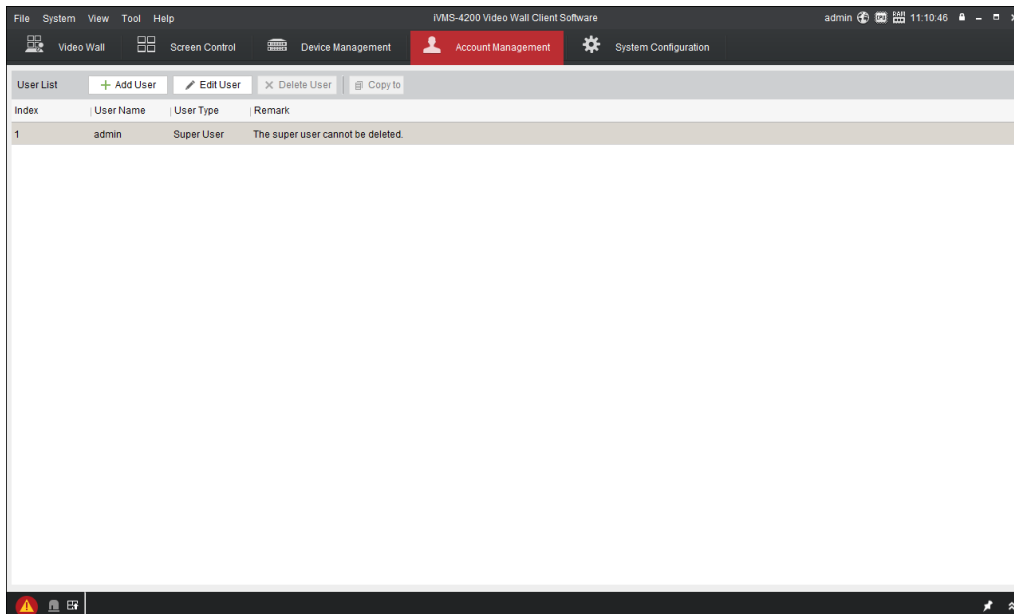

Figure 3-26 Account Management Interface

Step 2 Click **Add User** button to enter **Add User** interface.

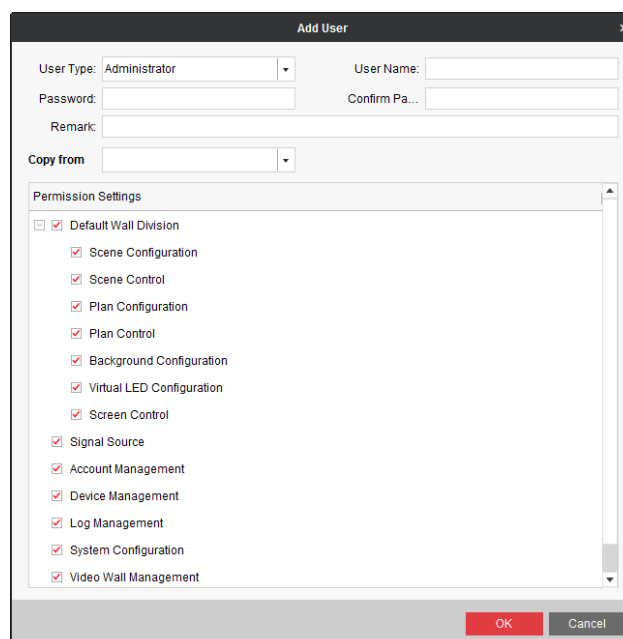

Figure 3-27 Add User

Step 3 Select **User Type** as **Administrator** or **Operator**.

Step 4 Input **User Name**, **Password**, **Confirm Password**, **Remark** and specify user permission by checking or unchecking corresponding checkbox. Or you can click **Copy from** to copy the configuration from other users.

 **NOTE**

- User Name cannot contain: \ / : * ? " < > |.
- The length of password should not less than 6 bits.

Step 5 Click **OK** to add the account.

Step 6 (Optional) Click **Edit User** to modify the parameters or click **Delete User** to delete it.

 **NOTE**

Super user cannot be deleted.

3.6 Configuring System Settings

Purpose

The frequently-used parameters, including the log expired time, file saving path, etc., can be set.

3.6.1 Configuring General Settings

Step 1 Click **System Configuration** in the Quick Launch Bar to enter **System Configuration** interface.

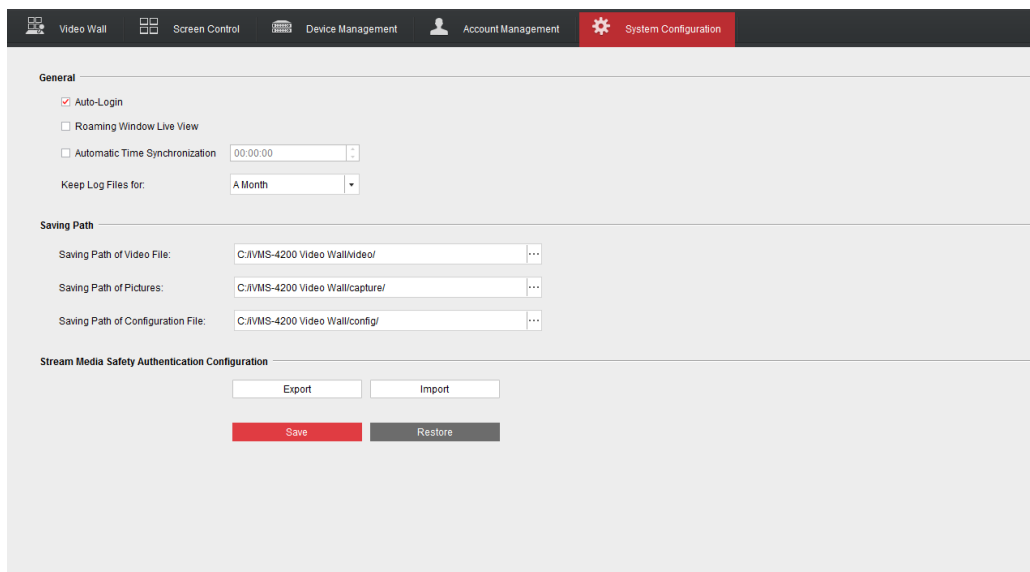

Figure 3-28 System Configuration

3. Configure the general parameters. For details, see *Table 3-9 General Parameters*.

Table 3-9 General Parameters

Parameters	Description
Auto-Login	Check the checkbox to log in to the client software automatically.
Roaming Window Live View	Check the checkbox to enable live view of the roaming window.
Automatic Time Synchronization	Check the checkbox to enable automatic time synchronization.
Keep Log Files for	Set the time for keeping the log files. Once the size exceeds the limit, the files will be deleted. A Month, A Week, Half A Month and 6 Months are selectable. The default time is A Month.

3.6.2 Configuring File Saving Path

Purpose

The video files of manual recording, the captured pictures and the system configuration files are stored in the local computer. The saving paths of these files can be set.

- Step 1 Click **System Configuration** in the Quick Launch Bar to enter **System Configuration** interface.
- Step 2 Click the icon  and select a local path for the files.
- Step 3 Click **Save** to save the settings.

 **NOTE**

You need to reboot the software to activate the settings.

Chapter 4 Managing Video Wall via the Software

4.1 Configuring Video Wall

4.1.1 Adding a Video Wall

Purpose

The software supports adding video walls. You can specify the row, column, virtual window division and decoding outputs of the video wall.

Step 1 Click **Video Wall** in the Quick Launch Bar to enter **Video Wall** interface.

Step 2 Click the  icon.

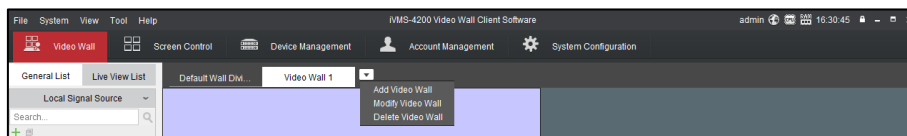

Figure 4-1 Video Wall Interface

Step 3 Select **Add Video Wall** to enter **Add Video Wall** interface.

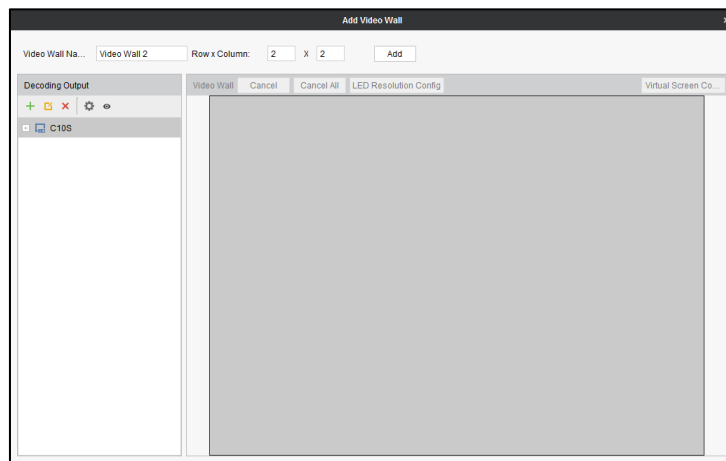

Figure 4-2 Add Video Wall

Step 4 Input **Video Wall Name** in the text field and input **Row** (1 to 16) and **Column** (1 to 20) value in the respective text fields.

Step 5 Click **Add** to add the video wall.

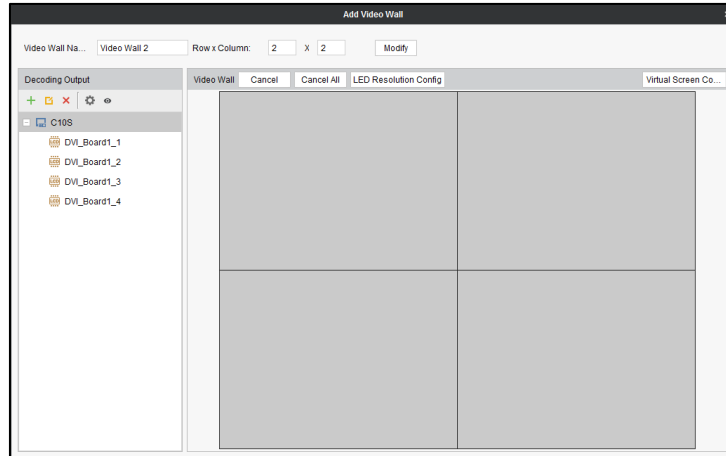



Figure 4-3 Added Video Wall

- Step 6 (Optional) You can reset the name, row and column of the video wall and click **Modify** to modify the settings.
- Step 7 (Optional) You can add, edit and delete devices, configure the general parameters of video wall and show the output No. of the device.

● **Adding a Device**

- 1) Click  to enter the **Add a Device** interface.

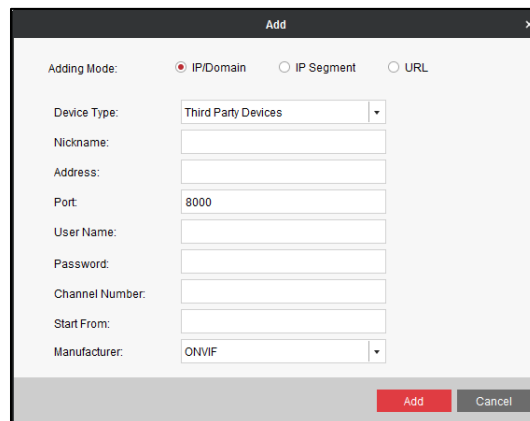



Figure 4-4 Add a Device

- 2) Select **Adding Mode** as **IP/Domain** or **IP Segment**.
- 3) Input the other information in corresponding text fields.
- 4) Click **Add** to add the device.

● **Modifying the Added Device**

- 1) Select an added device and click .

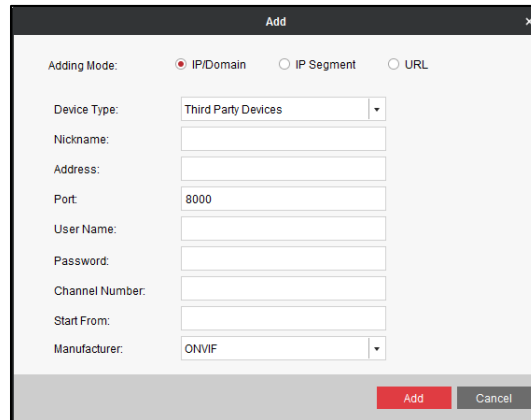



Figure 4-5 Modify the Device

- 2) Edit the information.
- 3) Click **Modify** to save the changes.

- **Deleting a Device**

Select a device and click  to delete it.

- **Configuring the General Parameters of Video Wall**

- 1) Select the added controller and click .

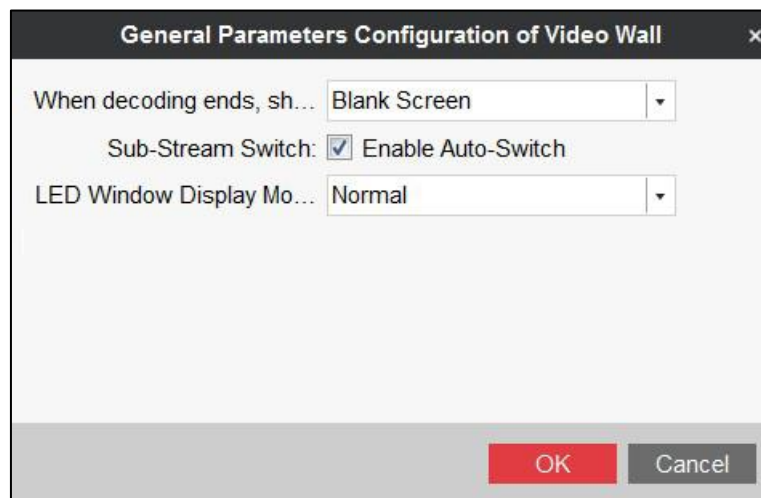

Figure 4-6 Configure General Parameters of Video Wall

- 2) Select **Blank Screen** or **Last Frame** when decoding ends.
If you select **Blank Screen**, the screen will change blank when the decoding ends. If you select **Last Frame**, the screen will show the last frame when the decoding ends.
- 3) Check **Enable Auto-Switch** of **Sub-Stream Switch**.
The device will switch to sub-stream decoding automatically if the output resolution of decoding window is lower than 640 × 640.
- 4) Select the **LED Window Display Mode**.

Normal Mode and **Tile Mode** are selectable.

 **NOTE**

In **Tile Mode**, up to 8 video layers are supported for single channel output. But window roaming, zooming in and zooming out are not supported.

● **Showing Output No.**

- 1) Click the  icon.

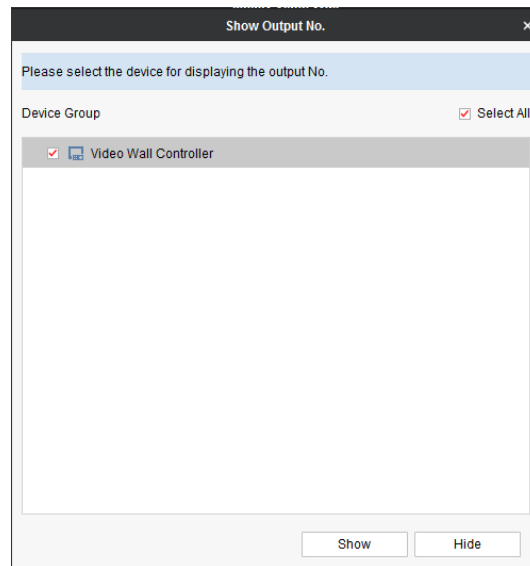

Figure 4-7 Show Output No.

- 2) Select the device(s) you need to display the output No.
- 3) Click **Show** to enable the function. Thus the output No. of the selected device(s) will be shown on the video wall.

Step 8 Select a decoding output and drag it to a window.

Step 9 Repeat Step 8 to link more decoding outputs to the video wall. For the detailed steps, refer to *Chapter 4.1.2 Linking Video Output to the Video Wall* for reference.

4.1.2 Linking Video Output to the Video Wall

Purpose

Linking the video output to the video wall is to display the signals on the video wall.

Step 1 Enter the **Add Video Wall** interface.

Step 2 Drag video output channels from the left-side list to the video wall layout to link the video output channel to the video wall.

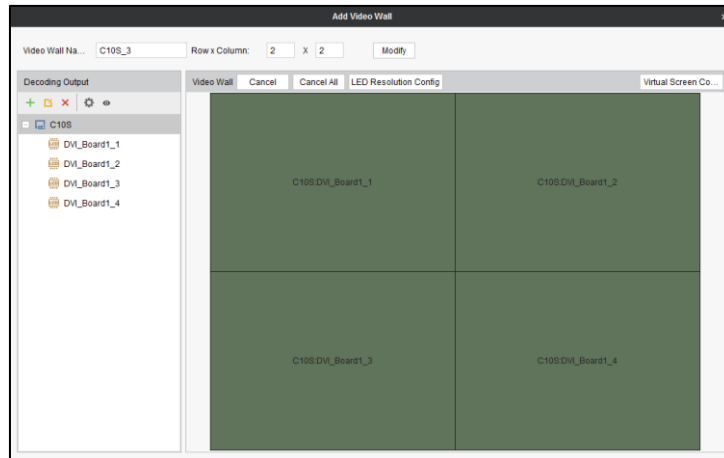

Figure 4-8 Link Video Output to the Video Wall

Step 3 (Optional) You can select a linked display window and click **Cancel** to release the linkage, or click **Cancel All** to release all the linked windows.

Step 4 Click **Modify** to save the settings.

4.1.3 Modifying Output Resolution

Purpose

The DS-C10S-SXXT series Video Wall Controller provides multiple output resolutions. You can configure the LCD and LED output resolution.

Step 1 In the **Video Wall** interface, select the target video wall and click  icon.

Step 2 Select **Modify Video Wall** to enter the **Modify Video Wall** interface.

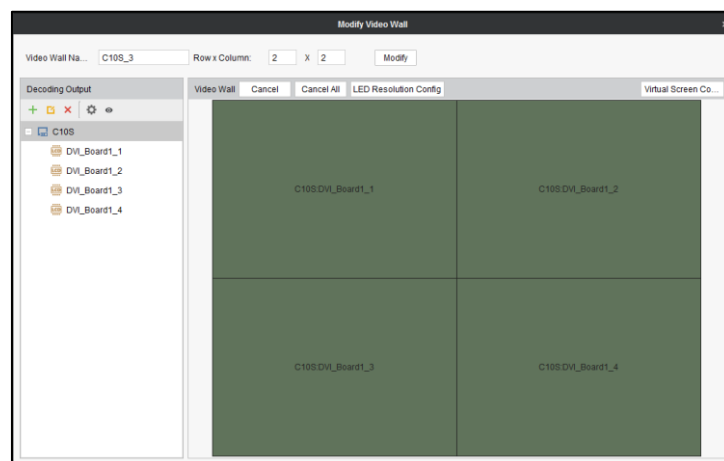



Figure 4-9 Modify Video Wall Interface

Step 3 Select the target output channel from the left-side list and click  to enter the **Edit Output** interface.

Step 4 Edit the output resolution. You can select **LCD** or **LED** output type. For LED output, it has advantages in brightness, consumption, visual angle and refreshing rate over LCD output.

- **Option 1: LCD**

- 1) Select the **Output Type** to be **LCD**.
- 2) Select the resolution from the **Output Resolution** drop-down list.

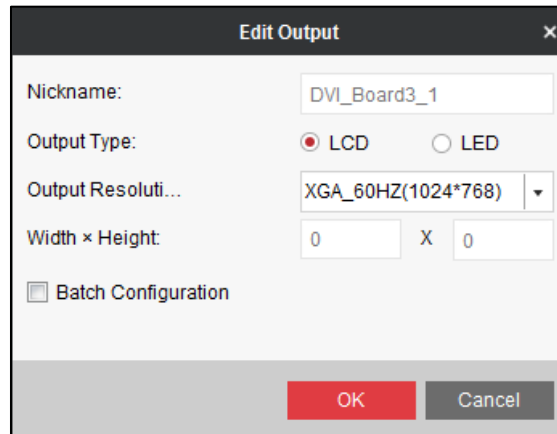

Figure 4-10 Select LCD Output Type

- **Option 2: LED**

- 1) Select the **Output Type** to be **LED**.
- 2) Input the width and height of LED in the corresponding text fields.

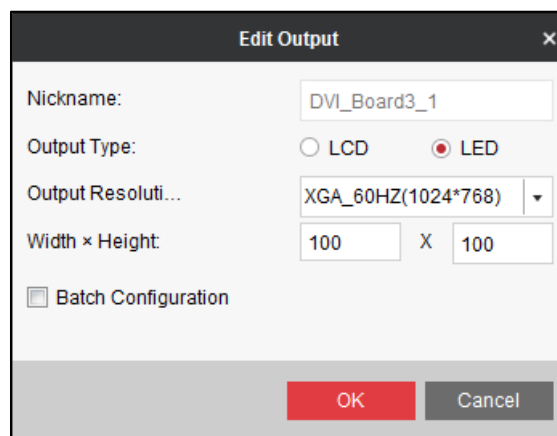

Figure 4-11 Select LED Output Type

 **NOTE**

The device is self-adaptive to the configured LED resolution.

- 3) Check the checkbox of **Batch Configuration** and select the outputs you want to set the same parameters.

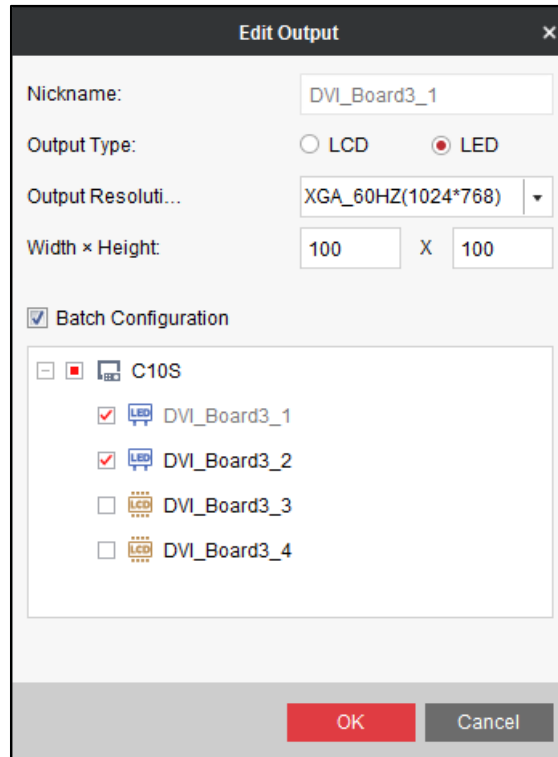

Figure 4-12 Batch Configuration

- 4) Click **OK** to save the changes and the LED area will change to blue.

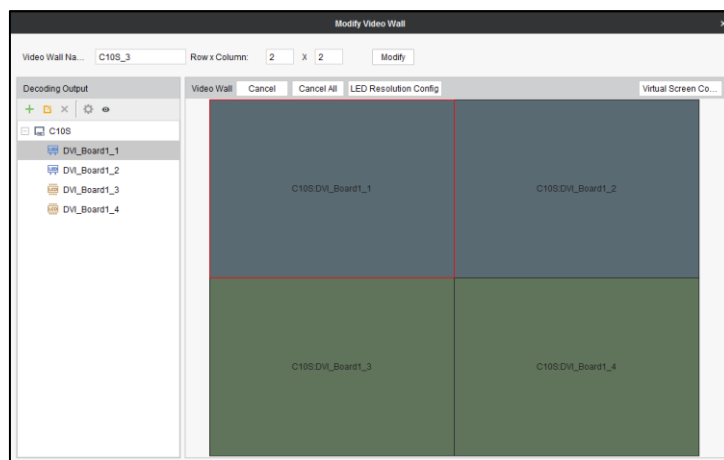

Figure 4-13 LED Output

- 5) (Optional) Select the LED area and click LED Resolution Config to configure the LED resolution. Input the LED **Resolution** and click **OK** to save the settings.

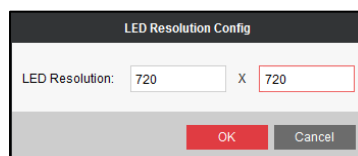



Figure 4-14 Configure LED Resolution

4.1.4 Setting Virtual Screen

Purpose

Video wall layout is restricted by the physical screen and in practice, one physical screen usually displays more than one signal source. Virtual screen layout allows one physical screen to display multiple signal sources and get rid of the restriction of physical screen.

Step 1 Click **Video Wall** in the Quick Launch Bar to enter **Video Wall** interface.

Step 2 Click the  icon.

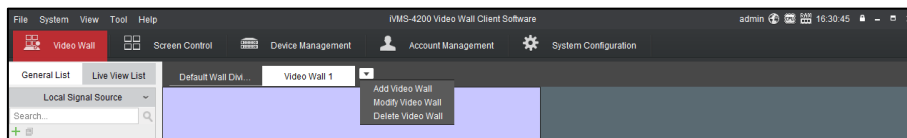

Figure 4-15 Video Wall Interface

Step 3 Select **Modify Video Wall** to enter the configuration interface.

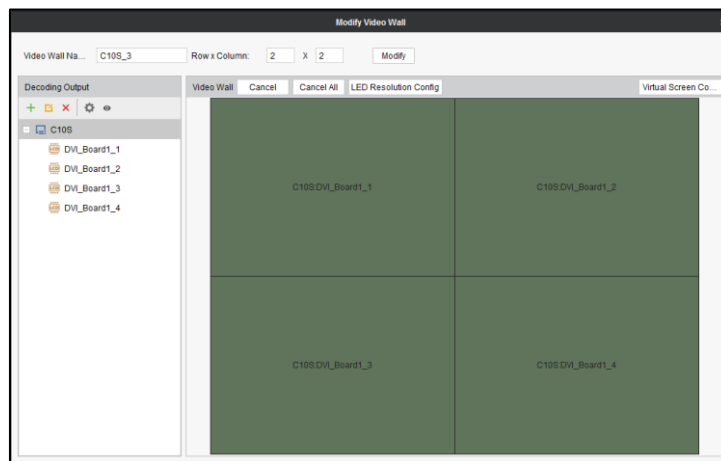

Figure 4-16 Modify Video Wall

Step 4 Select the output area for adding virtual screen.

Step 5 Click **Virtual Screen Config** to expand the **Virtual Screen Configuration** menu.

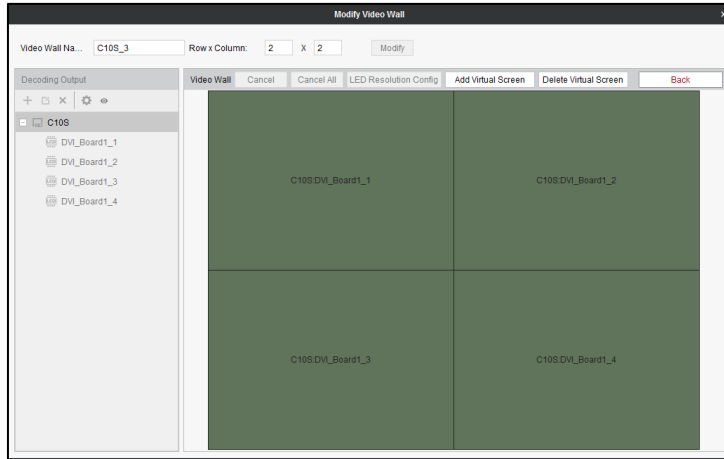

Figure 4-17 Configure Virtual Screen

Step 6 Select the output area you want to add virtual screen.

NOTE

Only the area with the same output type can be selected to add virtual screen.

Step 7 Click **Add Virtual Screen** to enter **Configure Virtual Screen** interface.

- 1) Select a **Virtual Screen Mode** from and input the row and column number.

NOTE

For the mode, the row number ranges from 1 to 16 and column number ranges from 1 to 20. For modes such as , the row number ranges from 2 to 16 and the column number ranges from 2 to 20. For modes such as , the row number ranges from 2 to 16 and the column number ranges from 3 to 20.

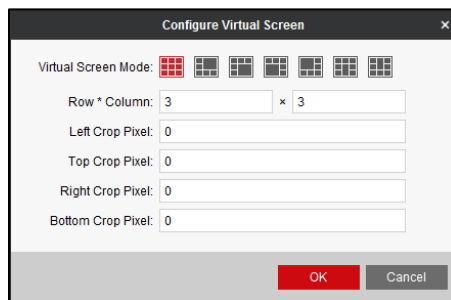

Figure 4-18 Configure Regular Virtual Screen

- 2) Input the **Left Crop Pixel**, **Top Crop Pixel**, **Right Crop Pixel** and **Bottom Crop Pixel** in the corresponding text fields.
- 3) Click **OK** to save the settings and the dotted line in grey constitutes the regular virtual screen division.

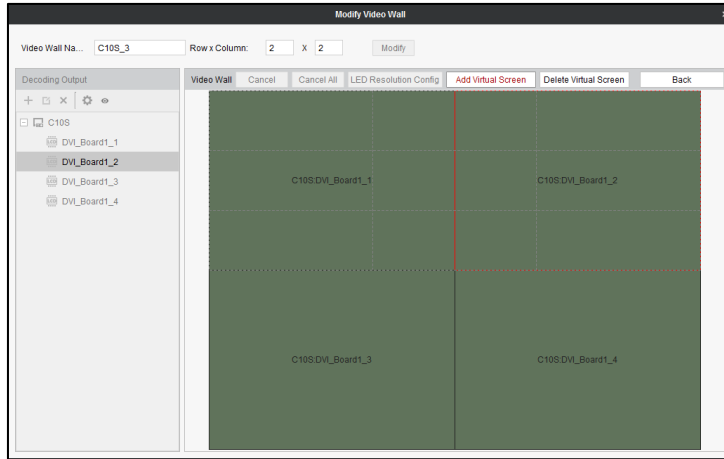

Figure 4-19 Added Regular Virtual Screen

- Step 8 (Optional) Select the configured virtual screen area and click **Delete Virtual Screen** to delete it.
- Step 9 On the video wall interface, drag a signal source to the window, and you can view the live view in the virtual video layout.

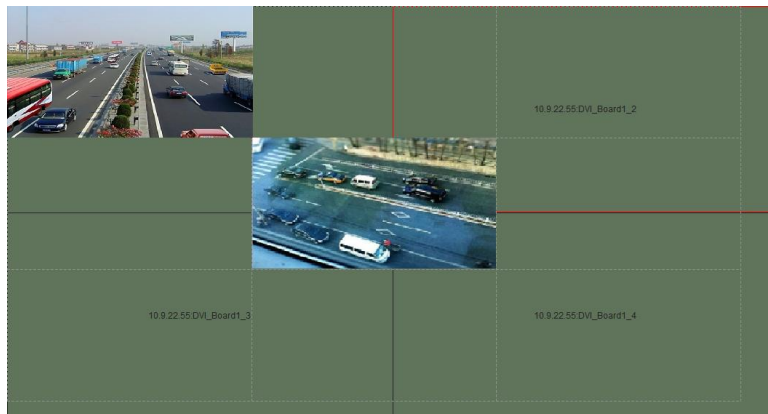

Figure 4-20 Live View in Virtual Screen

 **NOTE**

For detailed operations of linking video output with the video wall, refer to *Chapter 4.1.2 Linking Video Output to the Video Wall*.

4.2 Managing Signal Sources and Cameras

4.2.1 Managing Signal Sources

Purpose

The added video wall controllers and decoding devices will be listed in the signal source list of **Video Wall** interface. You can manage added controllers and add new controllers here.

Besides in the **Device Management** interface, you can also add controller in the **Video Wall** interface.

Before you start

Activate the controllers to be added. For detailed operations, refer to *Chapter 3.2.1 Activating the Video Wall Controller*.

Adding a Controller

Step 1 Enter the **Video Wall** interface.

Step 2 Click  in Signal Source List to enter the **Add a Controller** interface.

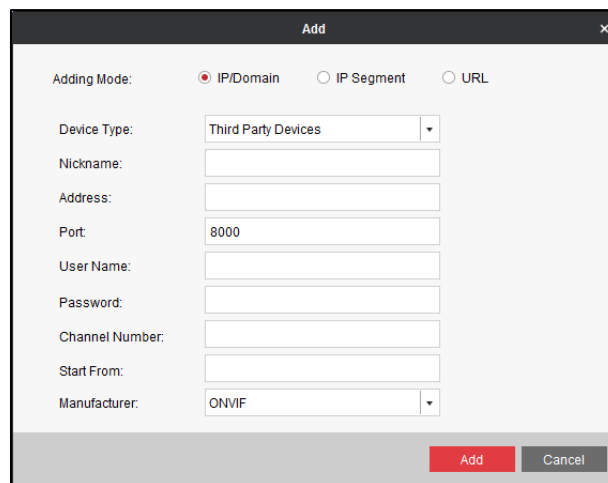

Figure 4-21 Add a Controller

Step 3 Input the parameters. For detailed operations, refer to step 5 of *Chapter 2.4 Using the Wizard for Basic Configuration*.

Step 4 Click **Add** to add the controller.

Modifying the Added Signal Source

Step 1 Select a signal source of the added controller from the Signal Source List.

Step 2 Click  to modify the added signal source.

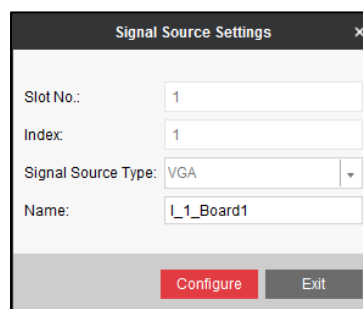

Figure 4-22 Modify the Signal Source

Step 3 Edit the name of the signal source in the **Name** text field.

Step 4 Click **Configure** to save the settings.

Managing Distributed Network Signal Source

Before you start

Add the distributed network signal sources in **Distributed Source Management** of remote configuration. Refer to *Chapter 3.3.5 Configuring Other Settings* for reference.

After successful distributed network source configuration, the distributed signal sources will be listed in the Network Signal Source List of **Video Wall** interface. And you can display it on the video wall as shown below.

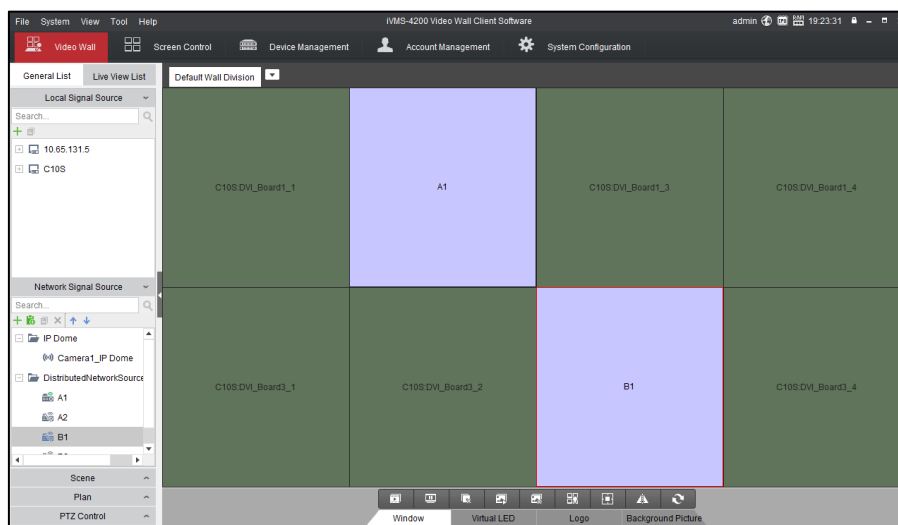

Figure 4-23 Display Distributed Signal Sources



NOTE

The information of the distributed network signal sources will be saved in the device and not be affected by the device startup and shutdown.

4.2.2 Managing Cameras

Purpose

Besides in the **Device Management** interface, you can also manage cameras in the **Video Wall** interface.

Before you start

Activate the cameras to be added in the **Device Management** interface. For detailed operations, refer to *Chapter 3.2.1 Activating the Video Wall Controller*.

Adding a Camera Group

Purpose

You should add a camera group first and then add cameras into the group.

Step 1 Click  in Network Signal Source List to enter the **Add Group** interface.

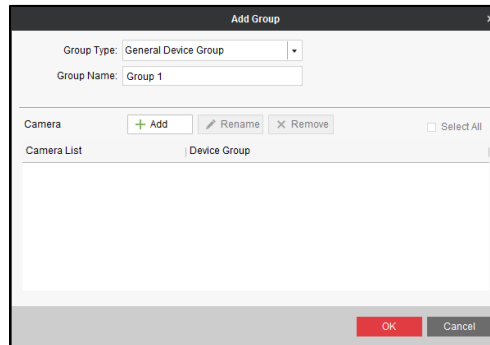
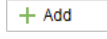

Figure 4-24 Add Group

Step 2 Select the **Group Type**. **General Device Group** and **Third-Party Device Group** are selectable.

Step 3 Input the **Group Name** in the text field.

Step 4 Click  to enter the **Add Camera** interface. The cameras you have added in the **Device Management** interface will be listed in the Device Group list. The name is the nickname you have set when adding the camera in the **Device Management** interface. The Encoding Channels list shows the cameras in the group.

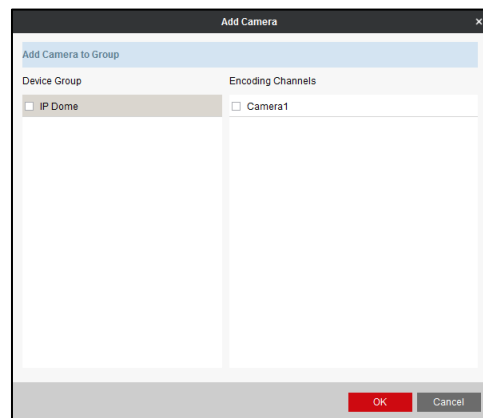

Figure 4-25 Add Camera

Step 5 Check the checkbox of the camera you want to add in the **Encoding Channels** list. You can also check the checkbox of the device in the **Device Group** list to add all the cameras under the group.

Step 6 Click **OK** to add the camera and the added camera will be listed in the **Add Group** interface.

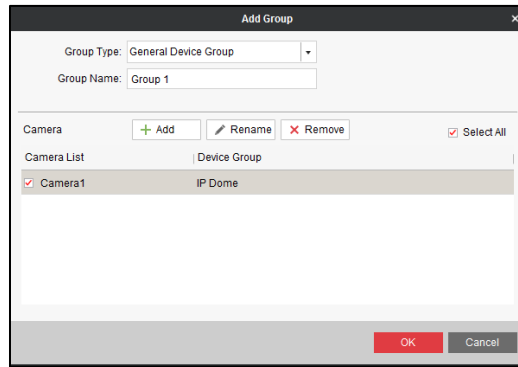

Figure 4-26 Added Group

Step 7 (Optional) Select a camera and click  **Rename** to rename it or click  **Remove** to delete it.

Step 8 Click **OK** to add the group.

 **NOTE**

- Special characters such as / \ : * ? \ " < > | cannot be contained in the Group Name.
- Up to 256 groups can be added.

Adding a Camera

Purpose

After adding a camera group, you can add cameras into the group.

Step 1 Click  in Network Signal Source List to enter the **Add a Camera** interface.

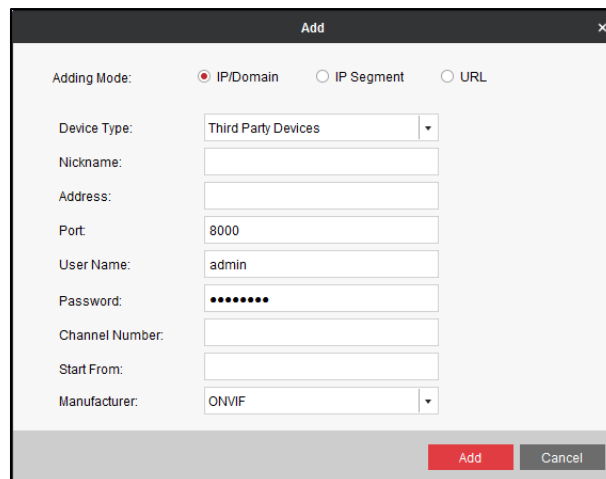

Figure 4-27 Add a Camera

Step 2 Input the parameters. For detailed operations, refer to step 5 of *Chapter 2.4 Using the Wizard for Basic Configuration*.

Step 3 Click **Add** to add the camera into the group.

Modifying the Camera Group

Purpose

The group name and cameras in the group can be modified.

- Step 1 Select a camera group from the Network Signal Source List and click  to enter the **Modify Group** interface.

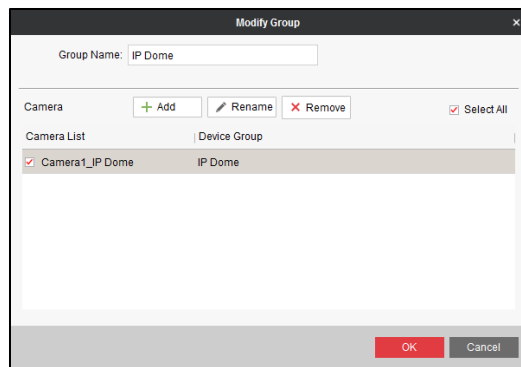
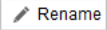



Figure 4-28 Modify Group

- Step 2 Edit the **Group Name**.

- Step 3 (Optional) Check the checkbox of the camera in the Camera List and click  to rename it or click  to delete it.

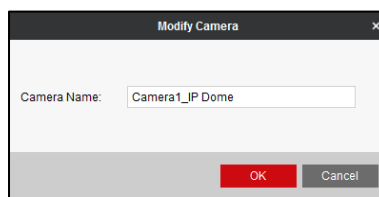



Figure 4-29 Modify Camera

- Step 4 Click **OK** to save the settings.

Modifying the Added Camera

Purpose

The name, stream type and protocol of the added cameras in a group can be modified.

- Step 1 Select the added camera under the group and click  to enter the **Modify Camera** interface.

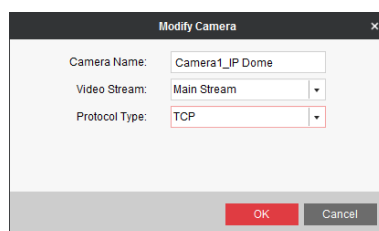



Figure 4-30 Modify Camera

Step 2 Edit the **Camera Name**. Select the **Video Stream** and **Protocol Type**.

Step 3 Click **OK** to save the settings.

Step 4 (Optional) You can also click  or  to adjust the camera position in the group.

4.3 Displaying Signals on the Video Wall

Purpose

The output screen of the controller can be divided into 1, 4, 9 or 16 windows. And the input signal sources can be displayed in the divided sub-windows.



The virtual screen cannot be divided.

4.3.1 Live View in Live View List

Step 1 Click **Live View List** in the left navigation bar.

Step 2 Click **Local Signal Source** to view the input signals of video wall controller in the live view list.

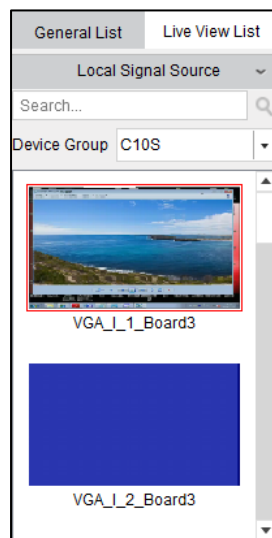

Figure 4-31 Local Signal Source Live View

Step 3 Click **Network Signal Source** to view the video of added cameras or distributed network sources.



Figure 4-32 Network Signal Source Live View

Step 4 (Optional) If there are multiple device groups, you can click ▾ to select the group and view the live video of the signal sources or cameras in the group.

4.3.2 Live View in Roaming Window

Purpose

Besides live view in the live view list, you can also realize live view in the roaming window.

Step 1 Click **System Configuration** in the Quick Launch Bar to enter **System Configuration** interface.

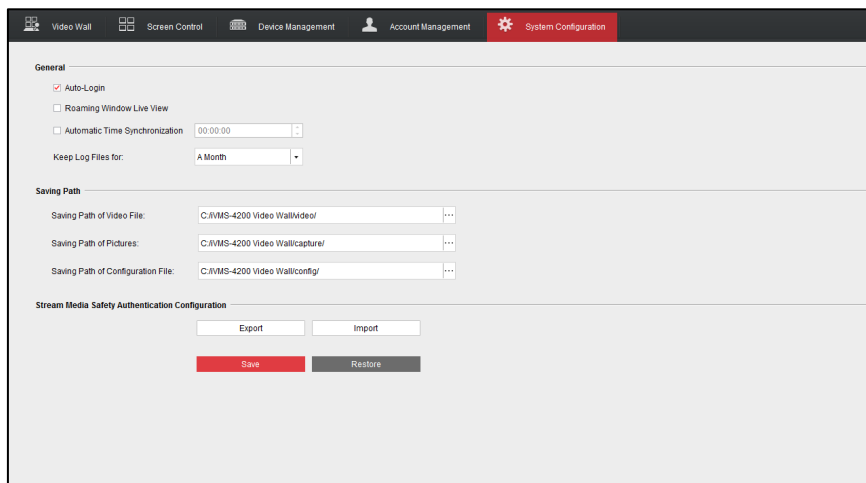

Figure 4-33 System Configuration Interface

Step 2 Check the checkbox of **Roaming Window Live View** to enable live view in the roaming window.

Step 3 Click **Save** to save the settings.

Step 4 Click **Video Wall** to enter the **Video Wall** interface. The successfully connected signal sources and cameras are displayed in the live view list. Drag a signal source or camera from the live view list to the video wall. You can also move the roaming window to any position of the video wall within the same output type.

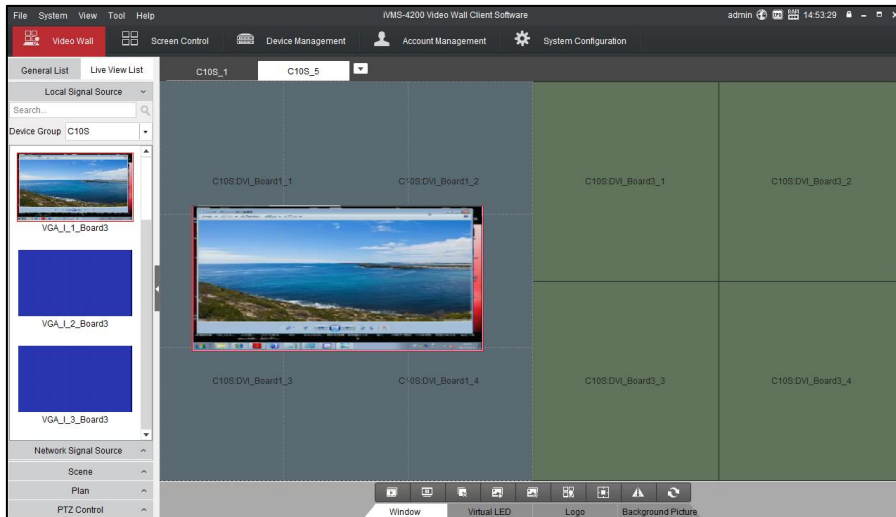

Figure 4-34 Live View of Signal Source in Roaming Window

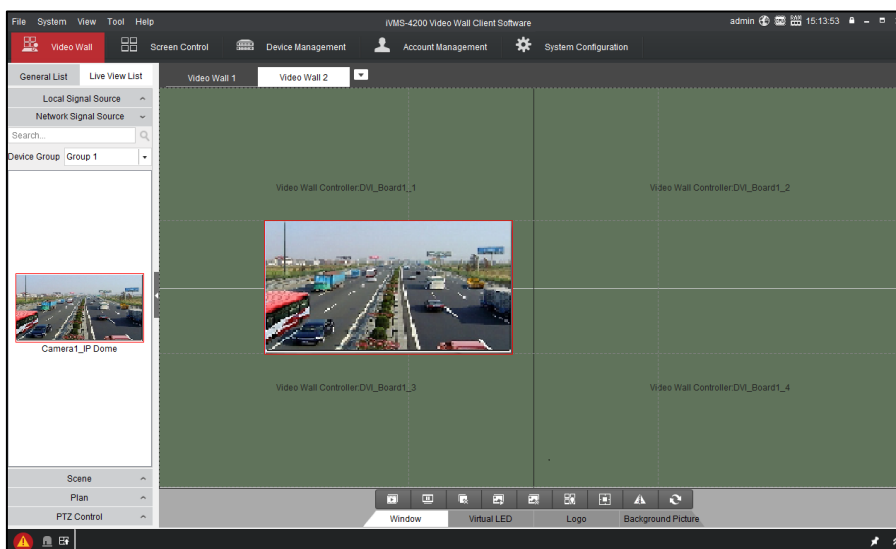

Figure 4-35 Live View of Camera in Roaming Window

NOTE

- The video wall controller supports live view of 64 channels simultaneously at most.
- If more than 32 channels are in live view, the resolution decreases to CIF automatically. Otherwise, the resolution increases to D1 automatically.

4.3.3 Displaying on the Video Wall

Purpose

A signal source or camera can be displayed on multiple windows. Ultra HD and 500 W signal can only be displayed on one window.

Step 1 Display a signal source or camera on the video wall.

- **Option 1: Dragging or Double-Clicking the Signal Source or Camera to the Video Wall**

- 1) Select an output window.
- 2) Drag or double-click a signal source or camera to the selected output window.
- 3) Repeat the step 1) to 2) to display more signal sources or cameras.

● **Option 2: Drawing a Window on the Video Wall**

- 1) Select a local signal source from the local signal source list or network signal source from the network signal source list.
- 2) Click  on Window Management Toolbar and drag the mouse to draw a window in the video wall.
- 3) Repeat the step 1) to 2) to display more signals.

 **NOTE**

Repeat step 2) only will display the same signal source or camera in multiple windows.

- 4) Click  again to release the function.

● **Option 3: Opening a Window via Coordinate**

You can refer to *Chapter 5.3.4 Opening the Window via Coordinate* for detailed operations.

Step 2 You can drag a signal source or camera window to overlap other windows. The window can be dragged to any position of the video wall within the same output type.

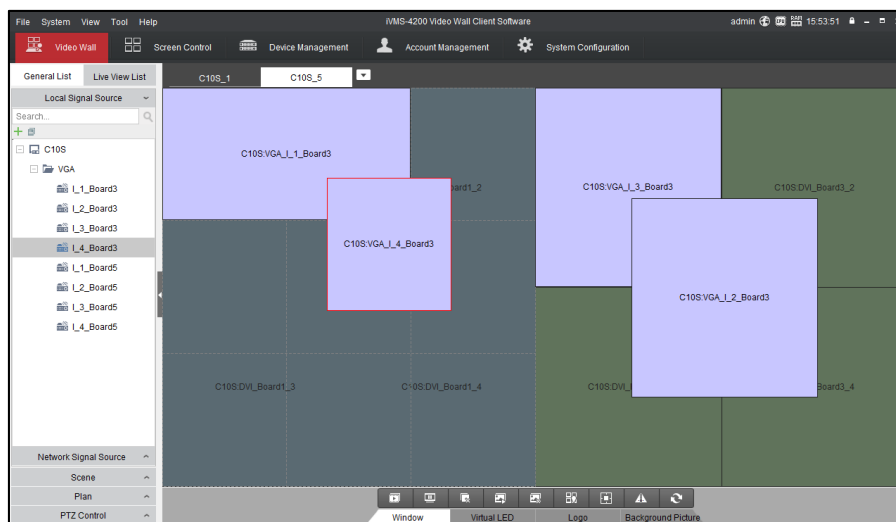

Figure 4-36 Display Local Signal Sources on Video Wall

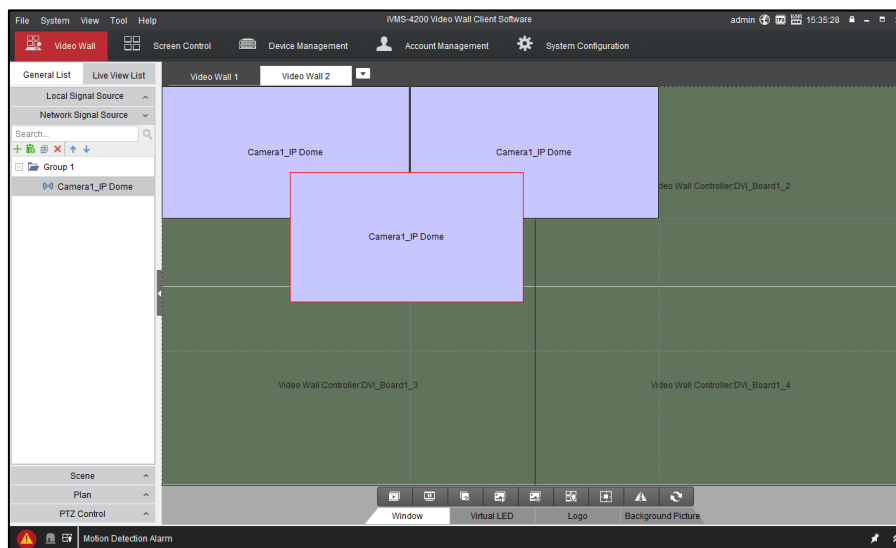







Figure 4-37 Display Cameras on Video Wall

- Step 3 Double-click a window to fill up the window(s) it overlaps.
- Step 4 Click  or  on Window Management Toolbar to start or stop live view of all the roaming windows.
- Step 5 (Optional) You can zoom in or zoom out the selected window by putting the mouse pointer on one of the four corners until the pointer changes to . Then drag the window to zoom in or zoom out.
- Step 6 Position the pointer on the window and click  on the upper right corner to close the window. Or click  on Window Management Toolbar to close all the windows.

4.3.4 Opening the Window via Coordinate

Purpose

On the LED screen you are allowed to open the window via coordinate.

- Step 1 Enter the **Video Wall** interface, select the LED screen and click the button  to open the window via coordinate.

The dialog box titled 'Open the Window via Coordinate' contains the following fields and controls:

- Device Name: C10S (dropdown menu)
- LED X-Coordinate: 0 (text input)
- LED Y-Coordinate: 0 (text input)
- X-Coordinate: 100 (text input)
- Y-Coordinate: 100 (text input)
- Width: 900 (text input)
- Height: 900 (text input)
- Buttons: OK (red), Cancel (grey)

Figure 4-38 Open the Window via Coordinate

- Step 2 Select the **Device Name** from the drop down list, and input the **X-Coordinate**, **Y-Coordinate**, **Width** and **Height**.

Step 3 Click **OK** to save the settings and the opened window will be displayed on the video wall.

 **NOTE**

- You cannot open the window via coordinate across both the non-LED and LED screens.
- You cannot edit the LED X-Coordinate and LED Y-Coordinate.
- The X-coordinate and Y-coordinate are relative output channel coordinates.
- For LED screen, the width and height of the opened window are same with the LED screen. When the width or height is smaller than that of the LED screen, a small window will be opened. When the width or height is bigger than that of the LED screen, a big window across multiple output channels will be opened.

4.4 Managing the Scene

Purpose

Scene is the layout of the video wall. You can add, modify, save the video wall layout, call, or delete the scene on the **Video Wall** interface. Up to 32 scenes can be added.

 **NOTE**

The scene information is saved in the video wall controller. That is to say, you can obtain the scenes of a controller created by others via adding it.

4.4.1 Adding a Scene

Step 1 Click **Scene** in the left navigation bar to show the **Scene** list.

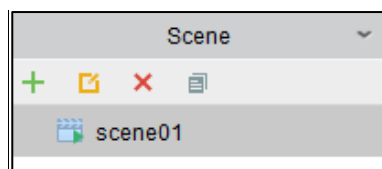



Figure 4-39 Scene List

Step 2 Click  button and input the **Name** to add a scene.

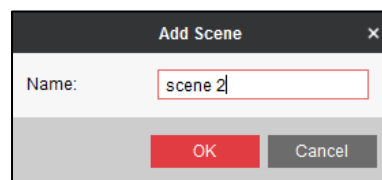

Figure 4-40 Add Scene

4.4.2 Modifying the Scene

Step 1 Select the added scene and click  to modify it.

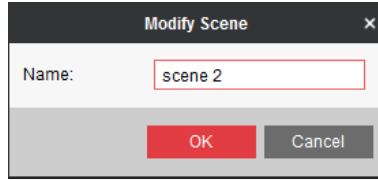



Figure 4-41 Modify Scene

Step 2 Edit the **Name** of the scene.

Step 3 Click **OK** to save the settings.

4.4.3 Saving the Video Wall Layout to the Scene

Step 1 Configure the video wall layout.

Step 2 Click  to enter the **Save Scene** interface.

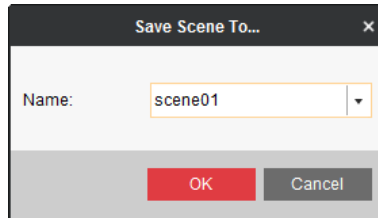

Figure 4-42 Save Scene

Step 3 Select the scene from the **Name** drop down list.

Step 4 Click **OK** to save the configured video wall layout to the selected scene.

NOTE

The tile mode of LED window can be saved in the scene. When you call the saved scene, you can also enable the tile mode.

4.4.4 Calling a Scene

Purpose

You can call a scene which you have configured to display it on the video wall.

Step 1 Position the pointer on a configured scene.

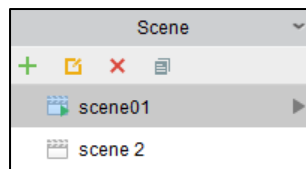



Figure 4-43 Scene List

Step 2 Click  to display the scene on the video wall. The called scene will be marked as .

4.4.5 Deleting a Scene

Step 1 Select a scene and click  to delete it.

Step 2 Click **OK** to delete the selected scene.

NOTE

- If there is only one scene and it is in use, it cannot be deleted.
- If there are more than one scene, and you want to delete the current scene, call other scene before deleting it.

4.5 Managing the Plan

Purpose

Plan is a function to configure a schedule to auto-switch the scenes on the video wall, and turn on/off the screen according to the configured time.

4.5.1 Adding a Plan

Step 1 Click **Plan** in the left navigation bar to show the **Plan** list..

Step 2 Click  to enter **Add Plan** interface.

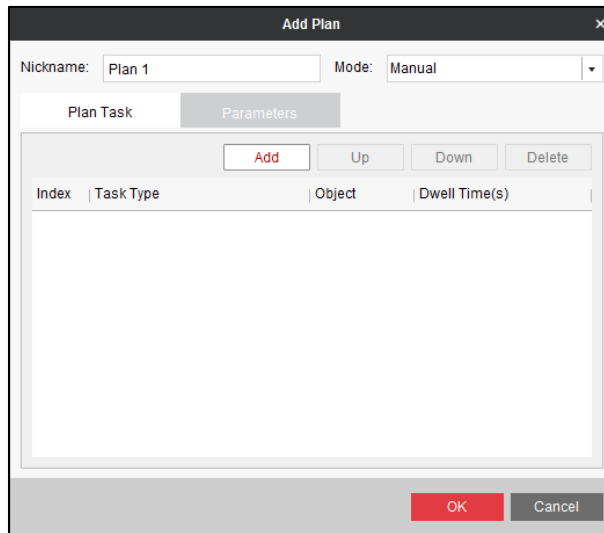

Figure 4-44 Add Plan

Step 3 Input **Nickname** in the text field.

Step 4 Select the **Mode** as **Manual**, **Auto** and **Auto-Switch** in the dropdown list.

- **Manual:** If you set the Mode of the plan as **Manual**, you need to start and stop the plan manually. And plan will only be activated once if you start it. To call the manual plan, you need to right-click on the plan and click **Call** on the right-click menu.

- **Auto:** When setting the Mode of the plan as **Auto**, you can set the start time and execution times for the plan. The plan will be activated on the start time and stopped after execution is finished.
- **Auto-Switch:** The **Auto-Switch** mode means that not only the execution times can be set, the days on which the plan gets activated can also be scheduled. The plan will be activated at the time of the day you configured and stopped after execution is finished.

Step 5 Click **Plan Task** tab to add or edit plan task.

Step 6 Click **Add** to enter **Add Task** interface.

Figure 4-45 Add Task

Step 7 Select **Task Type**, **Scene** and **Screen Type** in respective dropdown list. And set the **Dwell Time**.



NOTE

If you select the **Task Type** as **Display Scene**, the **Screen Type** is not editable. If you select the **Task Type** as **Open/Close Screen**, the **Scene** is not editable.

Step 8 Click **OK** to add the task.

Step 9 Repeat the steps from 6 to 8 to add more tasks.

Index	Task Type	Object	Dwell Time(s)
1	Display Scene	scene01	10
2	Open Screen	LCD-S1	3610
3	Close Screen	LCD-S1	7210

Figure 4-46 Plan Task

Step 10 (Optional) You can move the task up or down by clicking **Up** or **Down** button. Or delete the task by clicking **Delete** button.

Step 11 If the **Mode** is set as **Auto** or **Auto-Switch**, you need to click **Parameters** tab to configure the schedule.

For **Auto**: Set the **Start Time** and input **Execution Times**.

For **Auto-Switch**: Set the execution time for each weekday and input **Execution Times**.

The screenshot shows the 'Add Plan' dialog box with the following details:

- Nickname:** Plan 1
- Mode:** Auto
- Plan Task:** Parameters (selected)
- Start Time:** 2016-05-12 17:34:33
- Execution Times:** 1
- Weekday Settings:**
 - Mon: 00:00:00
 - Tue: 00:00:00
 - Wed: 00:00:00
 - Thu: 00:00:00
 - Fri: 00:00:00
 - Sat: 00:00:00
 - Sun: 00:00:00
- Buttons:** OK, Cancel

Figure 4-47 Plan Settings for Auto Mode

The screenshot shows the 'Add Plan' dialog box with the following details:

- Nickname:** Plan 1
- Mode:** Auto-Switch
- Plan Task:** Parameters (selected)
- Start Time:** 2016-05-12 17:34:33
- Execution Times:** 1
- Weekday Settings:**
 - Mon: 00:00:00
 - Tue: 00:00:00
 - Wed: 00:00:00
 - Thu: 00:00:00
 - Fri: 00:00:00
 - Sat: 00:00:00
 - Sun: 00:00:00
- Buttons:** OK, Cancel

Figure 4-48 Plan Settings for Auto-Switch Mode

Step 12 Click **OK** to save the settings. And the added plan will be displayed in the plan list.

4.5.2 Calling a Plan

Step 1 Position the pointer on the added plan.

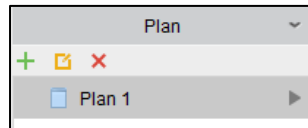



Figure 4-49 Plan List

Step 2 Click  to call the plan. The calling plan will be marked as .

Step 3 Click  to stop calling the plan.

4.5.3 Modifying a Plan

Step 1 Select a plan from the Plan List.

Step 2 Click  to modify the selected plan.

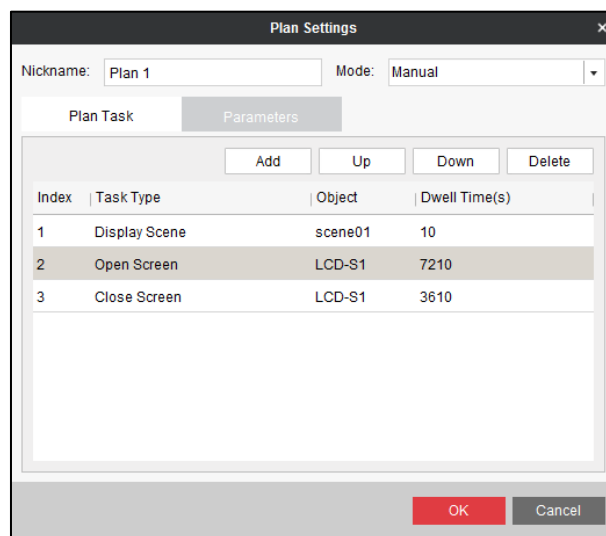

Figure 4-50 Modify a Plan

Step 3 Modify the **Name**, **Mode**, **Plan Task** or **Parameters** according to your needs.

Step 4 Click **OK** to save the settings.

4.6 PTZ Control

Purpose

The device supports PTZ control for the network and local signal sources. You can realize PTZ control for the signal sources with pan/tilt/zoom functionality.

NOTE

The PTZ control function should be supported by the connected signal source.

Before you start

Activate the signal source with pan/tilt/zoom functionality to be added on the **Device Management** interface. For detailed operations, refer to *Chapter 3.2.1 Activating the Video Wall Controller*. Display the signal source on the video wall. For detailed operations, refer to *Chapter 4.3.3 Displaying on the Video Wall*.

4.6.1 Controlling Network Signal Source

Purpose

For the connected network signal sources, you can realize PTZ control on the control panel directly.

Step 1 On the left Menu List of the **Video Wall** interface, click **PTZ Control** to expand the PTZ Control panel.

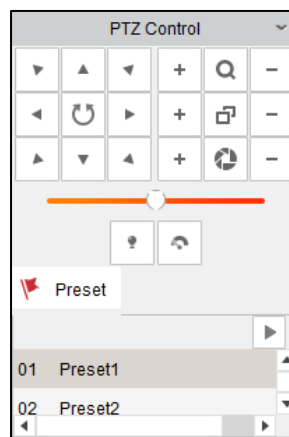

Figure 4-51 PTZ Control Panel

Refer to the following table for the description of the icons on the PTZ control panel.

Table 4-1 Description of the PTZ Control Panel Icons

Icon	Description	Icon	Description	Icon	Description
	Direction button and the auto-cycle button		Zoom+, Focus+, Iris+		Zoom-, Focus-, Iris-
	The speed of the PTZ movement		Light on/off		Wiper on/off
	Zoom		Focus		Iris

Step 2 Click the direction buttons and other buttons on the PTZ control panel to steer the network signal source to the desired view.

Step 3 Select a preset and click the icon to call the preset.

4.6.2 Controlling Local Signal Source

Purpose

For the connected local signal sources, you should set the serial port function to remote PTZ control in the remote configuration before realizing PTZ control.

Step 1 Enter the Motherboard Serial Port interface in Remote Configuration.

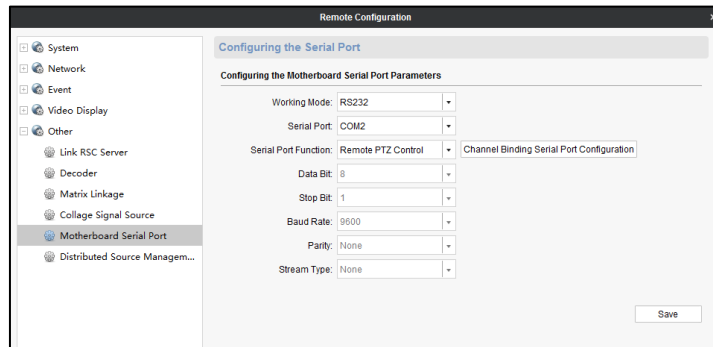

Figure 4-52 Motherboard Serial Port Configuration

Step 2 Select the **Serial Port Function to Remote PTZ Control**.

Step 3 Click **Camera Bound Serial Port Configuration** button to enter the interface below.

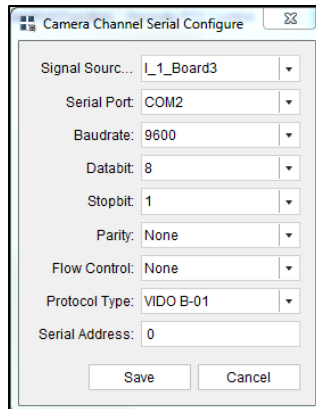

Figure 4-53 Camera Bound Serial Port Configuration

Step 4 Configure the serial port parameters and click **Save** to save the settings.

Step 5 Control PTZ of the local signal sources. Refer to *Chapter 4.6.1 Controlling Network Signal Source* for detailed operations.

4.7 Configuring Advanced Settings

Purpose

On the Advanced Settings Menu of the video wall, you can configure the window, virtual LED and background picture.

4.7.1 Configuring Window

Purpose

You can configure the window division mode, adjust the window position, lock/unlock the window, fill the window in full screen, control decoding, view the decoding status and play back record files on the **Window** Advanced Settings Menu.

Configuring Window Division Mode

Purpose

Each window can be divided into 1, 4, 9 or 16 sub-windows.

Step 1 Select a signal source or camera window.

Step 2 Click  on the Advanced Settings Area to pop up **Window Division Mode** interface.

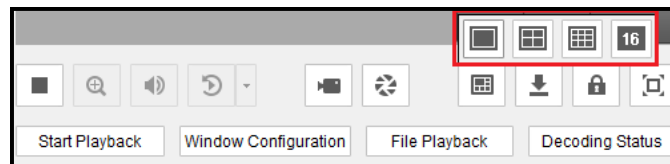

Figure 4-54 Configure Window Division Mode

Step 3 Select a window division mode. 1/4/9/16-window division modes are selectable. Then the window will be divided into the selected layout.

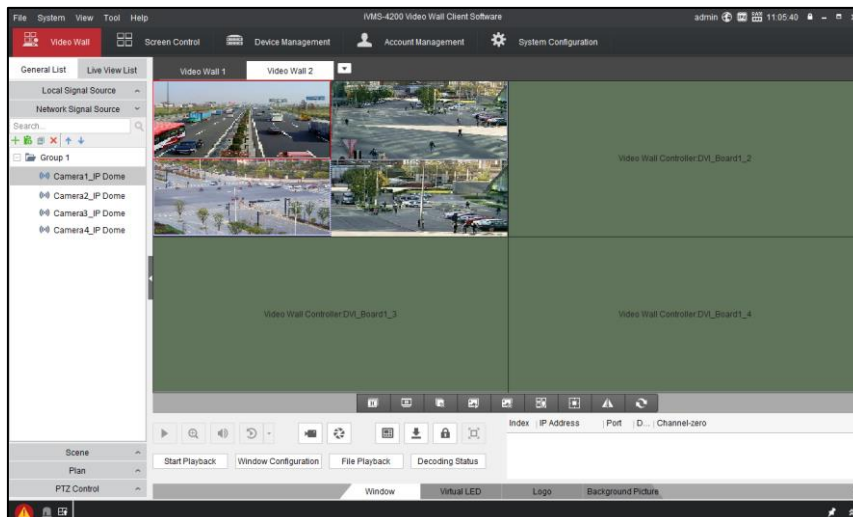

Figure 4-55 Configure Window Division Mode

Step 4 Click  again and select  to restore to single window.



NOTE

- The sub-window No. ranks from the left to the right and from the top to the bottom. E.g., in 4-window division mode, the sub-window No. ranks from 1 to 4 from the left to the right and from the top to the bottom.
- After the 4/9/16-window division mode is selected, the video displayed in a single window before will be displayed in sub-window of No. 1.
- The roaming window cannot be divided. The sub-window cannot be roamed.
- Drag the cameras in the Network Signal Source List to the sub-windows to display the video of the cameras on the respective sub-window.
- You can double-click a sub-window to fill it and then double-click it to restore to the division mode.

Adjusting the Window Position

Purpose

While multiple windows can be overlaid, you can stick one of them on top or at bottom, and keep the window sticking on top without having to changing their coordinates.

- **Sticking at Bottom:**

- 1) Click the window you want to stick at bottom.
- 2) Click  in Advanced Settings Area to adjust its position to the bottom..

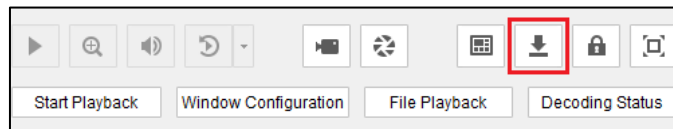

Figure 4-56 Stick the Window at Bottom

- 3) The selected window will be displayed on the bottom of other windows.

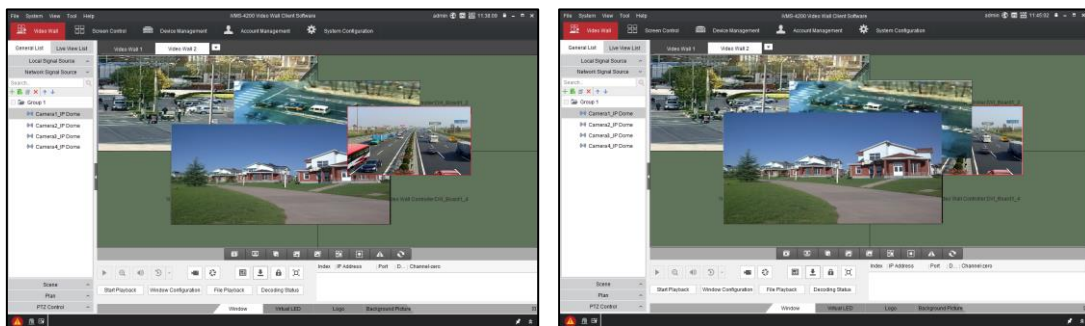



Figure 4-57 Before (Left) and After (Right) Sticking the Window at Bottom

- **Sticking on Top:**

Just select the window you want to stick on top and it will be displayed on top of other windows.

- **Keeping Sticking on Top:**

- 1) Select the window you want to keep sticking on top and right-click the window to pop up the right-click menu.
- 2) Click **Keep Sticking on Top** to keep the selected window sticking on top.

After the configuration, the  icon will appear on the upper right corner of the window and the window will keep sticking on top without being affected by the operations of other windows.

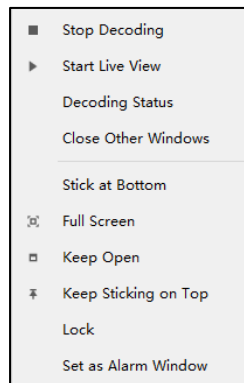

Figure 4-58 Keep Sticking on Top

- 3) (Optional) Click **Cancel Sticking on Top** on the right-click menu to cancel the selected window sticking on top.

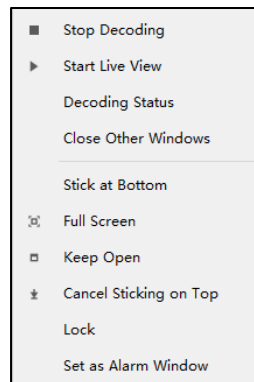

Figure 4-59 Cancel Sticking on Top

 **NOTE**

Only one window can be kept sticking on top for one system.

Adjusting the Window into Full Screen

Purpose

You can zoom in the window into full screen, or zoom it out to the original size.

 **NOTE**

This function is only available when the output type is the same. It is unavailable if there are both LCD and LED outputs.

Step 1 Select a window.

Step 2 Right click the window to enter the right-click menu.

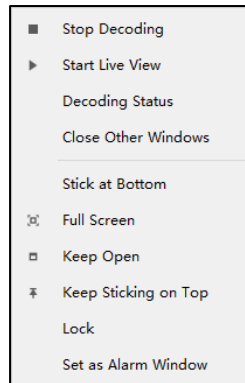

Figure 4-60 Right-Click Menu

Step 3 Click **Full Screen** to adjust the window into full screen mode.

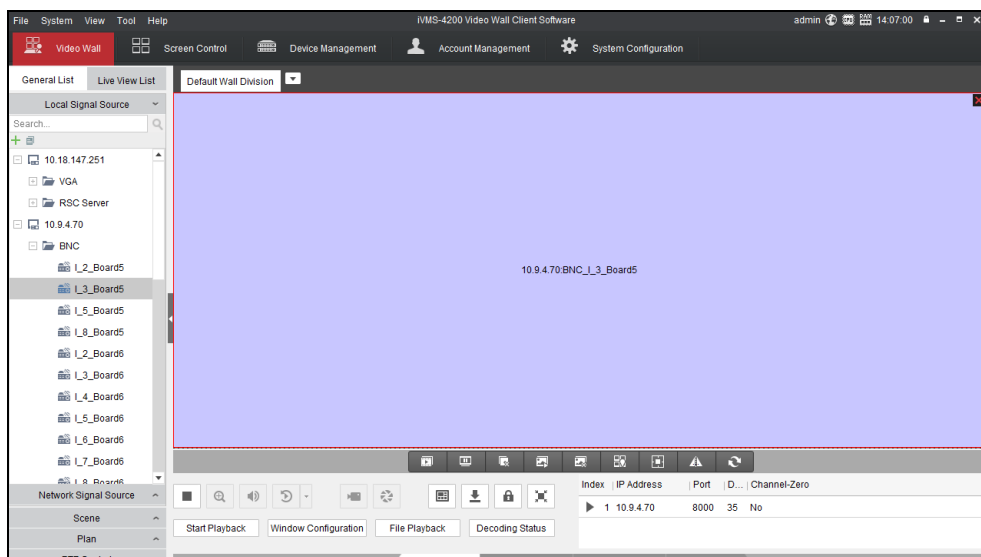

Figure 4-61 Adjust Window into Full Screen

Keeping the Window Open

Purpose

You can keep a window open, and it will not be affected by the scene or plan configuration.

Step 4 Select the window you want to keep open and right-click the window to pop up the right-click menu.

Step 5 Click **Keep Open** to keep the selected window open.

After the configuration, the  icon will appear on the upper right corner of the window and the window will keep open without being affected by the scene or plan configuration.

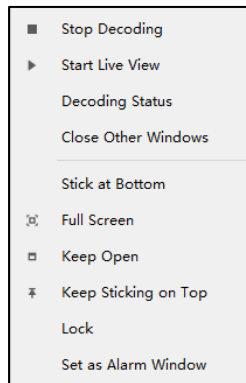

Figure 4-62 Keep the Window Open

Step 6 (Optional) Click **Cancel Keeping Open** on the right-click menu to cancel keeping the selected window open.

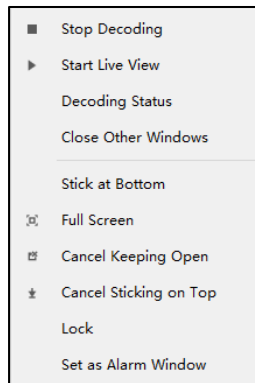

Figure 4-63 Cancel Keeping the Window Open



 **NOTE**

You cannot close the window if it is kept open. You can only cancel keeping it open before closing it.

Locking the Window

Purpose

You can lock a window, thus to fix it and prevent it from being closed.

Step 1 Select a window and click  in Advanced Settings Area to lock the window. Then the locked window will be marked with  on the upper-right corner of the window.

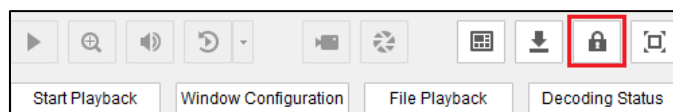

Figure 4-64 Lock the Window

Step 2 Click the  again to unlock the window.

Zooming in the Roaming Window in Screen with the Same Output

Purpose

You can zoom in the roaming window in screen with the same output on the horizontal or vertical direction.

Step 1 Select a window.

Step 2 Click  in Advanced Settings Area.

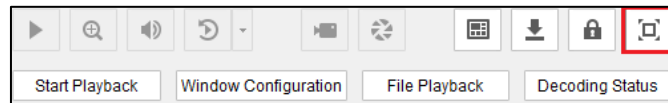

Figure 4-65 Zoom in Window

Step 3 Then the selected window will span the screen with the same output.

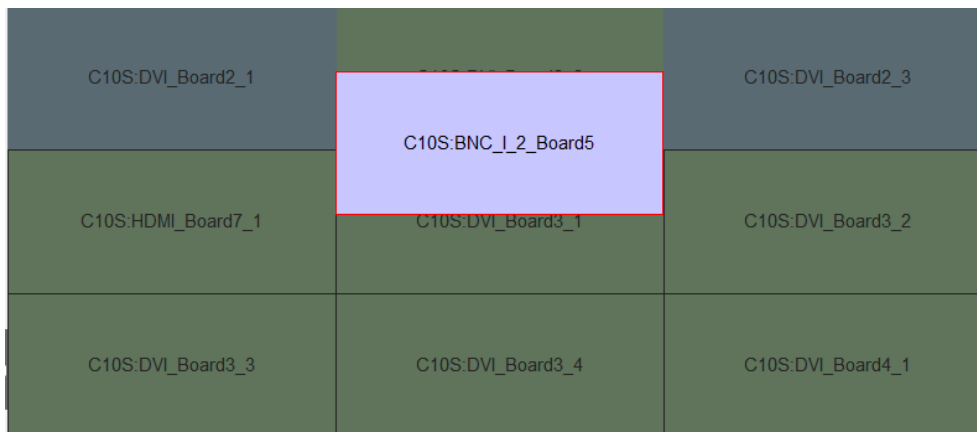

Figure 4-66 Before Zooming in

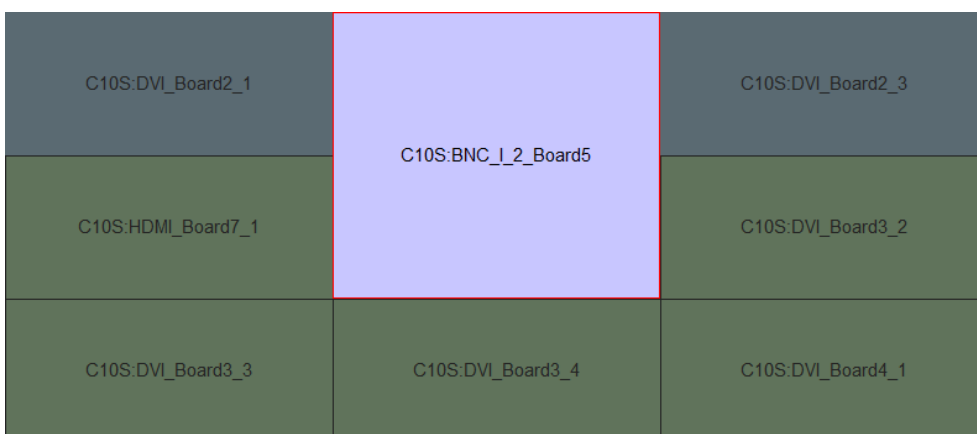

Figure 4-67 After Zooming in

Step 4 Click  again to zoom out.



You can also double-click the window to zoom in. And then double-click the window again to zoom out.

Controlling Decoding

Purpose

You can start or stop decoding of the signal source.

Step 1 Select a signal source window.

Step 2 Click  in Advanced Settings Area to start decoding of the signal source.

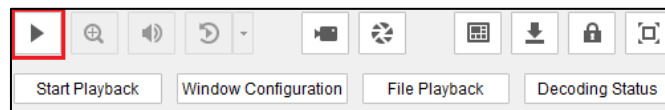



Figure 4-68 Start Decoding

Step 3 Click  again to stop decoding of the selected signal source.

NOTE

You can also click  in Window Management Toolbar to stop decoding of all the windows or click  to start decoding of all the windows.

Viewing Decoding Status

Purpose

You can view the decoding status of the signal source or camera.

Step 1 Select a window.

Step 2 Click **Decoding Status** in Advanced Settings Area to view the decoding status of the selected window.

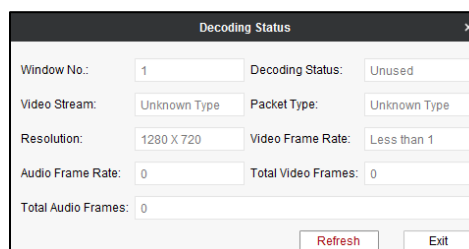

Figure 4-69 View Decoding Status

Step 3 You can view the decoding status on the interface. Click **Refresh** to refresh the status or click **Exit** to exit from the interface.

Playing Back Files

Purpose

You can play back the record files on the video wall.

Step 1 Select a window.

Step 2 Click **File Playback** in Advanced Settings Area to play back the record files.

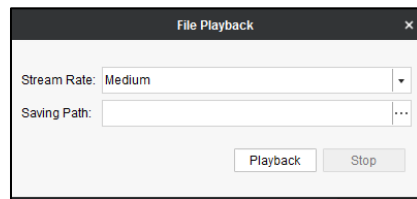

Figure 4-70 File Playback

Step 3 Select the **Stream Rate** from the dropdown list. 5 levels can be selected.

Step 4 Click **...** to select the **Saving Path** to open the record files.

Step 5 Click **Playback** to start playback or click **Stop** to stop it.

4.7.2 Mirroring Video Wall

Purpose

You can mirror the content of one video wall area to another.

Step 1 On the **Video Wall** interface, click  button to enable video wall mirror.

Then the different areas will appear on the video wall as shown below. The positions of the areas depend on the positions of the decoding outputs.

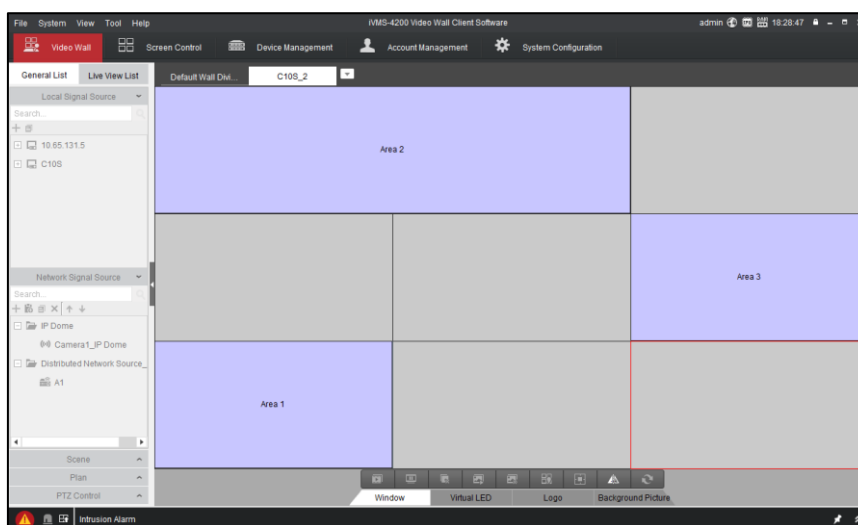

Figure 4-71 Enable Video Wall Mirror



NOTE

- The neighboring LCD decoding outputs belong to one area, and the neighboring LED decoding outputs belong to one area. The LCD and LED decoding outputs belong to different areas.
- Video wall mirror is only available when the areas are separate and not duplicated.

Step 2 Hold the mouse to drag one area to overlap another area and release the mouse. Then the dialog box pops up as below.

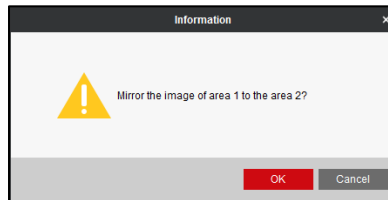

Figure 4-72 Dialog Box

Step 3 Click **OK** to mirror one area to another. Then the mirrored area will be marked as *Area X* (*Area Y Mirror*) (*Area X* refers to the mirrored area and *area Y* refers to the mirroring area) on the video wall as shown below.

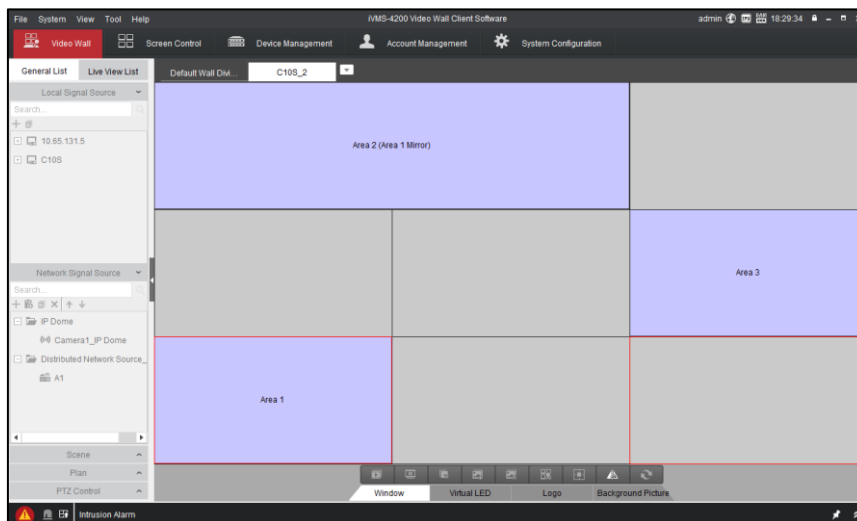

Figure 4-73 Mirrored Area

4.7.3 Configuring Virtual LED

Purpose

Virtual LED is the on-screen display of the text you want to show on the video wall. Only two text strings are supported at most for one output and three for the entire video wall. The font color and background color are configurable.

Step 1 Click **Virtual LED** tab on the Advanced Settings Menu.

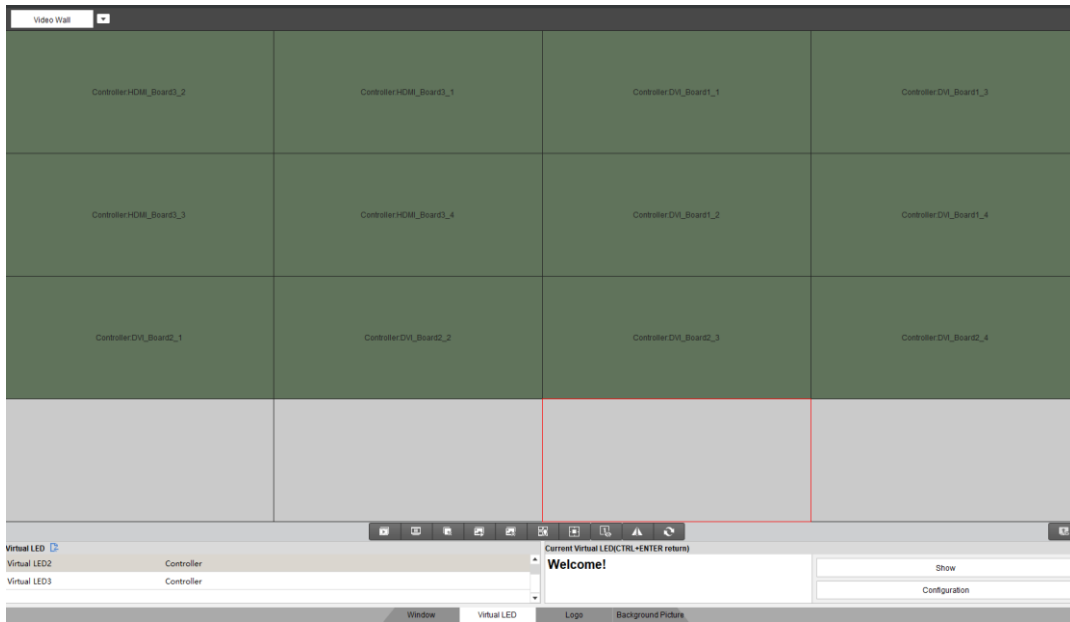



Figure 4-74 Configure Virtual LED

- Step 2 Click  to import a local font library. The file name must be in **font.ttf** format, and the size cannot exceed 10 MB.
- Step 3 Click an online video wall controller and input the content you want to show on the video wall in the **Current Virtual LED** text field.

 **NOTE**

Not more than 256 characters can be contained in the content.

- Step 4 Click **Configuration** to configure virtual LED parameters.

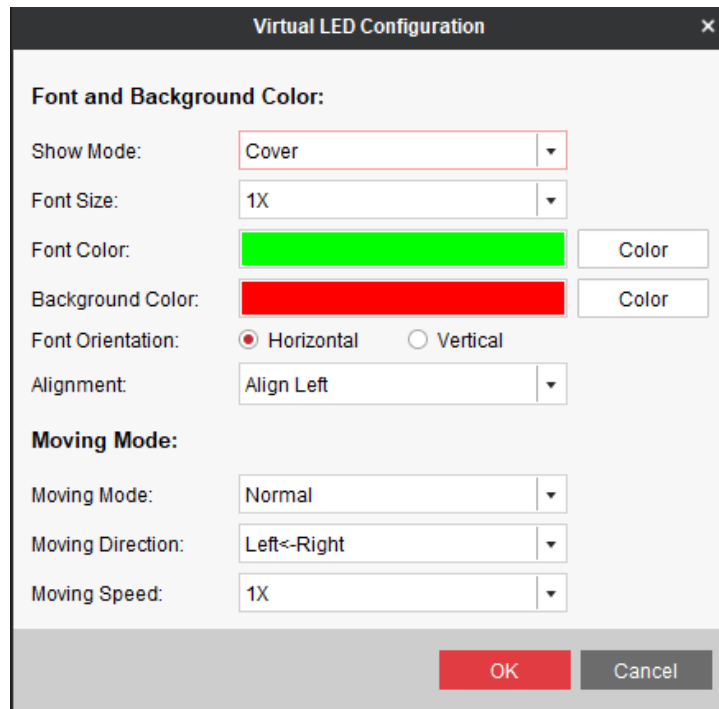

Figure 4-75 Virtual LED Settings

Step 5 Select the **Show Mode**, **Font Size**, **Font Color**, and **Background Color**.

Step 6 Select **Font Orientation** and **Alignment** accordingly.

Step 7 Set **Moving Mode**, **Moving Direction**, and **Moving Speed**.

 **NOTE**

Moving mode parameters are available only for horizontal LEDs. In **Normal** mode, the virtual LED content is scrolled and played and the moving direction can only be set as from right to left.

Step 8 Click **OK** to save the settings and back to video wall interface.

Step 9 Click **Show** to display the virtual LED or **Hide** to hide the virtual LED.

4.7.4 Configuring Background Picture

Purpose

Upload local picture as the background of output window.

Step 1 Click **Background Picture** on the Advanced Settings Menu.

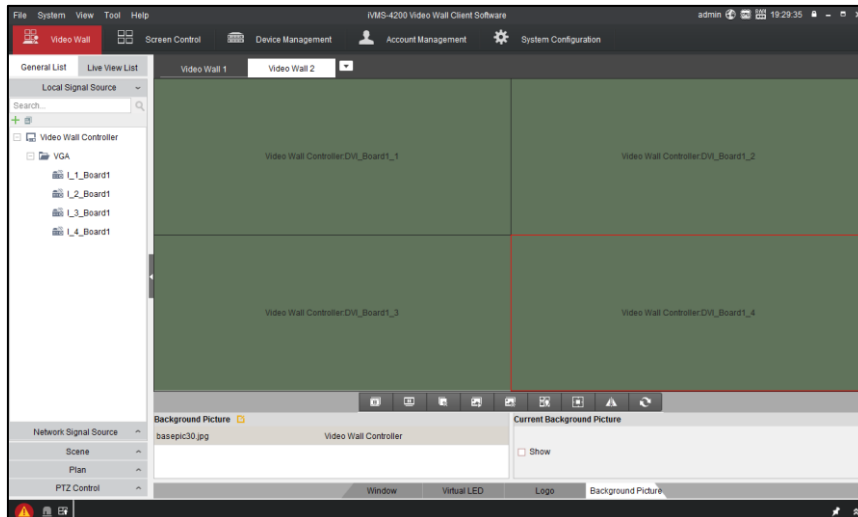



Figure 4-76 Configure Background Picture

- Step 2 Drag the background picture to the video wall. Or open window for the background picture.
- Step 3 Click  to select the background picture.
- Step 4 Select the picture path and click **Open** to upload the picture. The uploaded picture will replace the current picture.
- Step 5 Select a window.
- Step 6 Check the checkbox of **Show** to show the background picture on the selected window. Or uncheck the checkbox to disable it.

NOTE

- The supported resolution of background picture ranges from 1280 × 720 to 16384 × 8192.
- The supported formats of background picture are *.jpg and *.jpeg.
- The picture name cannot contain more than 32 characters.

4.8 Configuring RSC Server

4.8.1 Setting RSC Server

Purpose

The RSC Server software is used to remotely control other computers which are used for signal source output.

- Step 1 Install RSC Server software on signal source computer.

Step 2 On the **Status Interface** the server name and server password can be edited. The default password is 12345 which is entered in the **Server Password** text field and we highly recommend you to change the default password to avoid the security problem.



WARNING

STRONG PASSWORD RECOMMENDED—We highly recommend you create a strong password of your own choosing (Using a minimum of 8 characters, including at least three of the following categories: upper case letters, lower case letters, numbers, and special characters.) in order to increase the security of your product. And we recommend you reset your password regularly, especially in the high security system, resetting the password monthly or weekly can better protect your product.

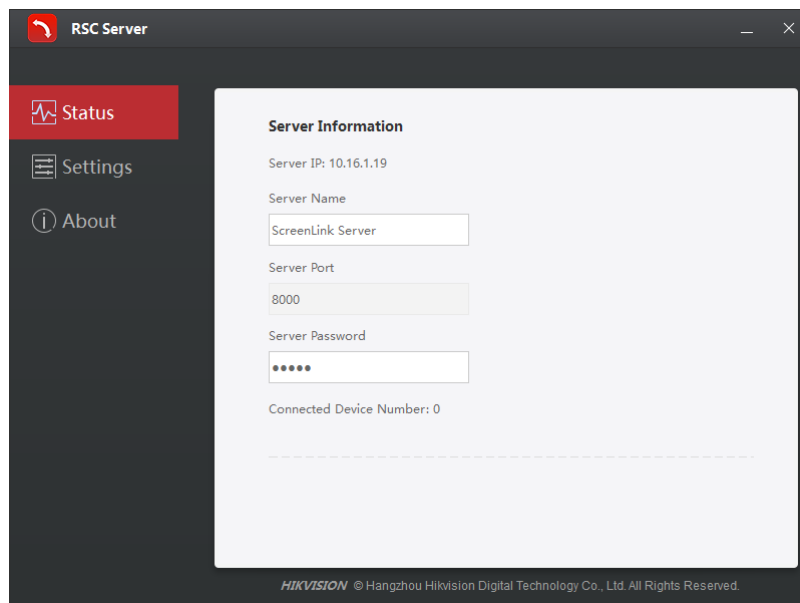

Figure 4-77 RSC Server Status Interface



NOTE

Reboot the server to take new settings into effect.

Step 3 Click **Settings** to enter the settings interface where you can set the saving path for files and only files like image, PPT and video can be previewed on the video wall.

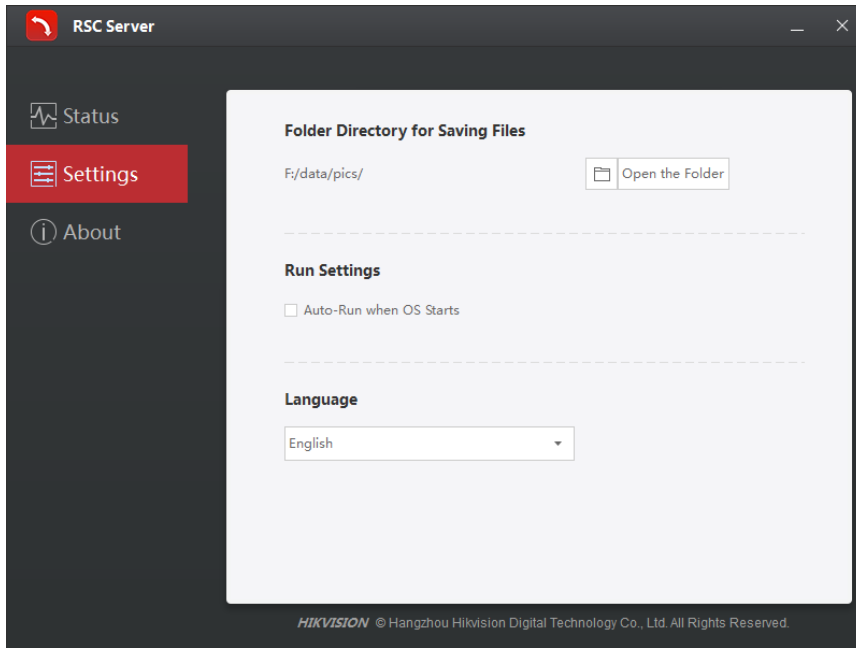

Figure 4-78 RSC Server Settings Interface

Step 4 Click **About** to get the version information.

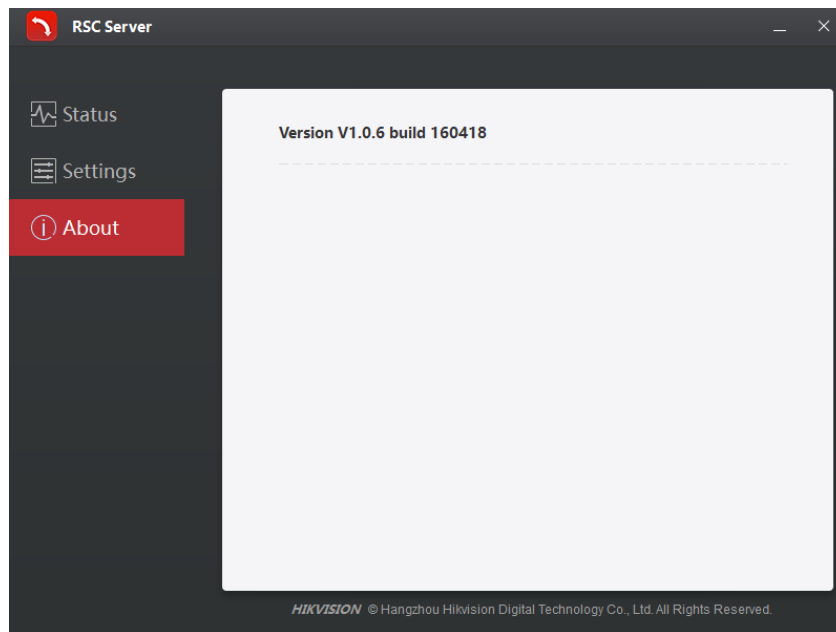

Figure 4-79 RSC Server Version Information

4.8.2 Remote Interaction

Purpose

After settings have done on the RSC Server software, you can realize remote interaction on the iVMS-4200 Video Wall Client Software.

Step 1 Log in to the iVMS-4200 Video Wall Client Software and click **Device Management** to enter the **Device Management** interface.

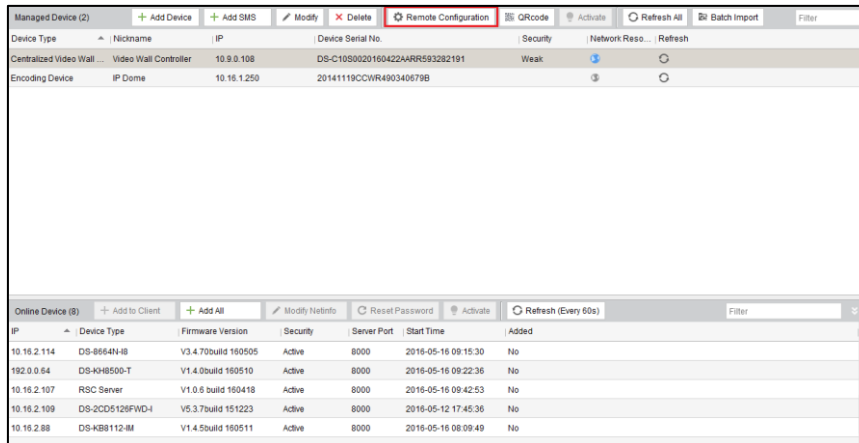

Figure 4-80 Device Management Interface

Step 2 Select the video wall controller and click **Remote Configuration** to enter the **Remote Configuration** interface.

Step 3 Click **Others** and select the **Screen Controller Server Bind** to enter the following interface.

Configuring and Binding Screen Controller Server

Configure Screen Controller Server Bind

Signal Name:

IP Version:

IP Address:

Port No.:

User Name:

Password:

Bind

Save

Figure 4-81 Bind Screen Controller Server

Step 4 Check the checkbox of **Bind**, select the **Signal Name** and **IP Version** from the dropdown list, and input the **IP Address**, **Port No.**, **User Name** and **Password** of the server to finish the bind.

NOTE

- In the text filed of **User Name**, input *admin* which is the only user name.
- The password here should be the same with the password set in the RSC server

Step 5 Return to the Video Wall interface, and drag the screen server signal source to the output window. Right-click the window and select **Screen Control** to remotely control the computer with the signal source.

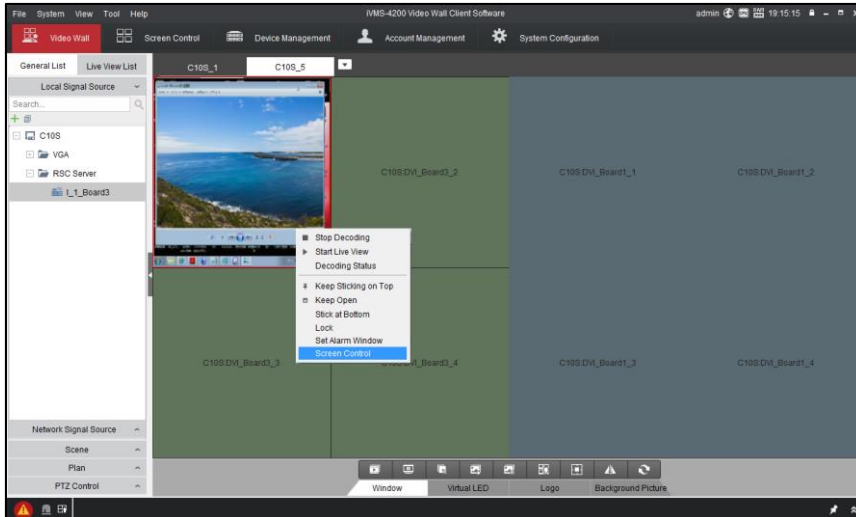

Figure 4-82 Video Wall Interface

Step 6 There are four icons on the upper right corner. Respectively they mean Image, Video, PPT and Remark.

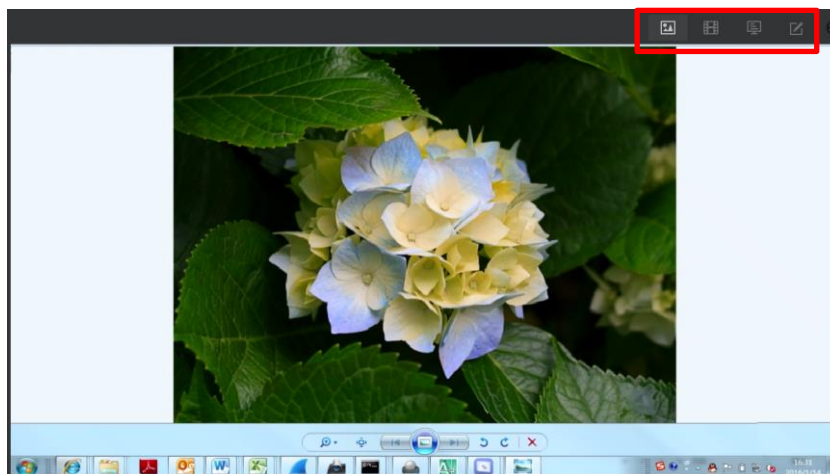

Figure 4-83 Screen Control Interface

1) Click  to display all the image files in the directory set in the RSC Sever.

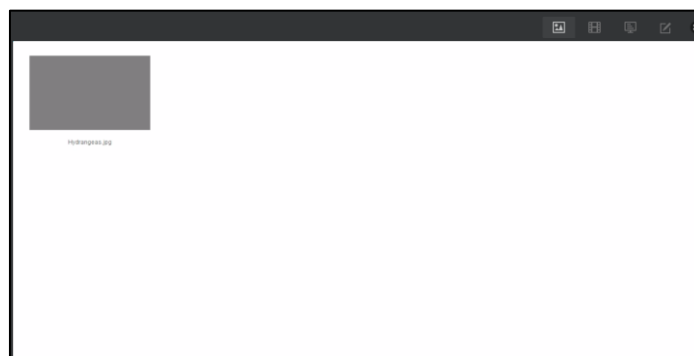



Figure 4-84 Screen Control Interface (1)

2) Click  to display all the video files in the directory set in the RSC Sever.

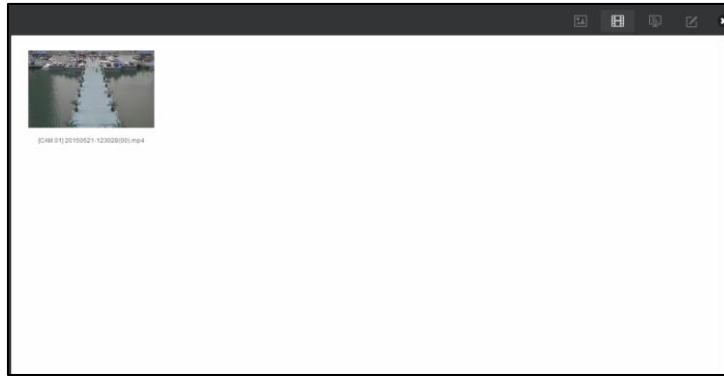

Figure 4-85 Screen Control Interface (2)

- 3) Click  to display all the PPT files in the directory set in the RSC Sever.

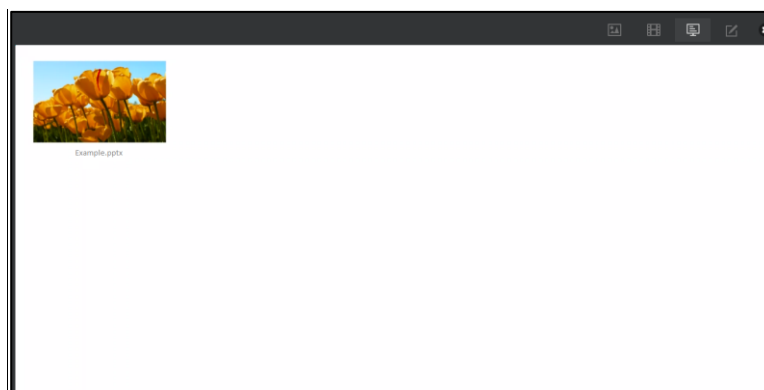

Figure 4-86 Screen Control Interface (3)

- 4) Click  to pop up the following remark tool bar. You can select a color and set the line width to make remarks on the PPT.



Figure 4-87 Remark Tool Bar

4.9 Setting the Custom Resolution on the Computer

Purpose

After the signal resolution is configured on the Remote Configuration interface and the signal output of the computer is connected to the input of the controller, you can select the configured custom resolution for the display of your computer.

NOTE

The width of the custom resolution must be a multiple of four, and the height must be a multiple of two.

- Step 1 Set the custom signal resolution on the **Signal Resolution** interface of Remote Configuration.

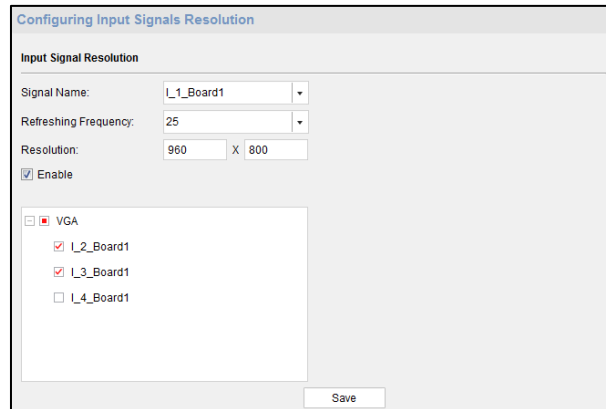

Figure 4-88 Configure Input Signal Resolution

Step 2 Enter the **NVIDIA Control Panel** on your computer and click **Change Resolution** to enter the following interface.

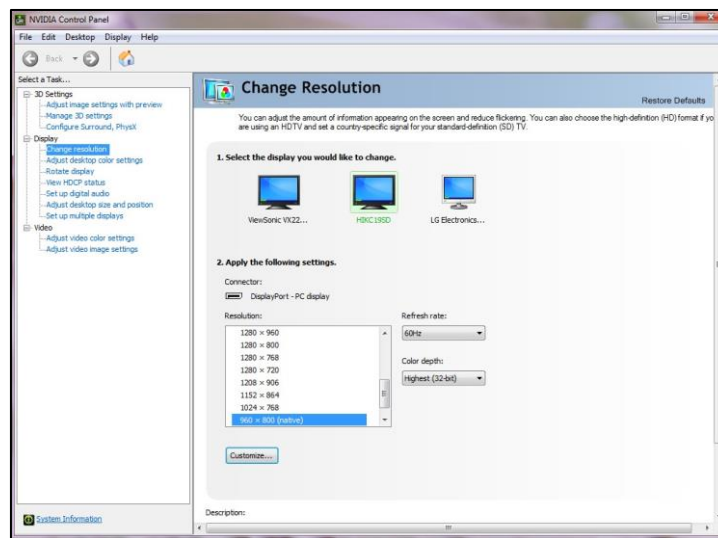

Figure 4-89 Change the Computer Resolution

Step 3 Select the custom resolution you have configured from the Resolution list.

4.10 Stream Media Server Configuration

Purpose

When the device network access channel number reaches the limit, or the network bandwidth is limited, you can realize real-time data transmission via stream media server to decrease the network pressure of the device.

4.10.1 Installing Stream Media Server

When you install iVMS-4200 video wall client software, install stream media server in the same layer of directory of the video wall client software.

4.10.2 Running Stream Media Server

Double click the desktop shortcut icon , or enter the installation directory (default: iVMS-4200 Video Wall\ iVMS-4200 Stream Media Server), to open the stream media server. The main page is shown as below.

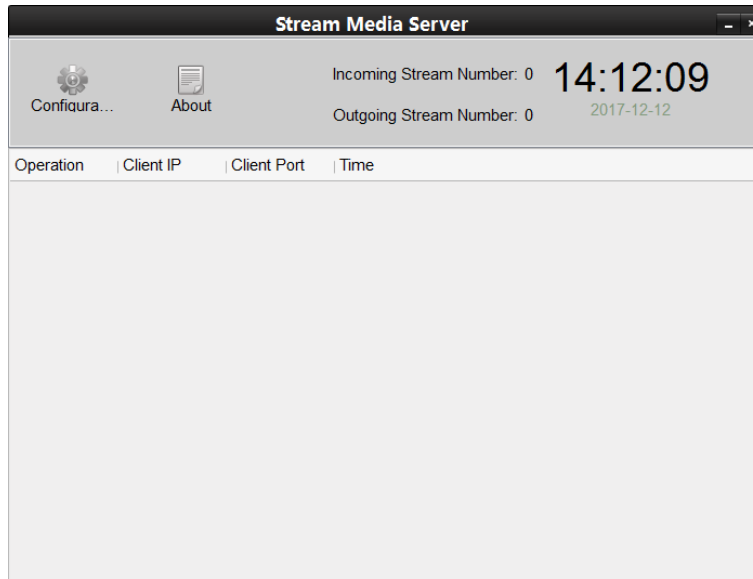



Figure 4-90 Stream Media Server

 will appear in the taskbar in the lower right corner of the desktop, indicating the server is running normally.

4.10.3 Adding Stream Media Server

Step 1 Open iVMS-4200 video wall client software.

Step 2 Click **Device Management**.

Step 3 Click **Add SMS**.

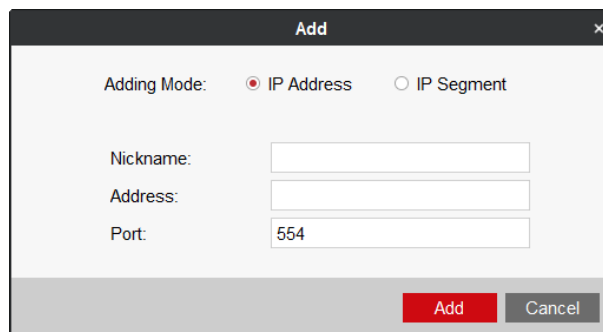

Figure 4-91 Add Stream Media Server

Step 4 Input **Nickname**, **Address**, and **Port**.

Step 5 Click **Add** to add the server.

4.10.4 Configuring Stream Media Server

Step 1 Click **System Configuration** of iVMS-4200 video wall client software.

Step 2 Click **Export** to export **Stream Media Safety Authentication Configuration** to the local PC.

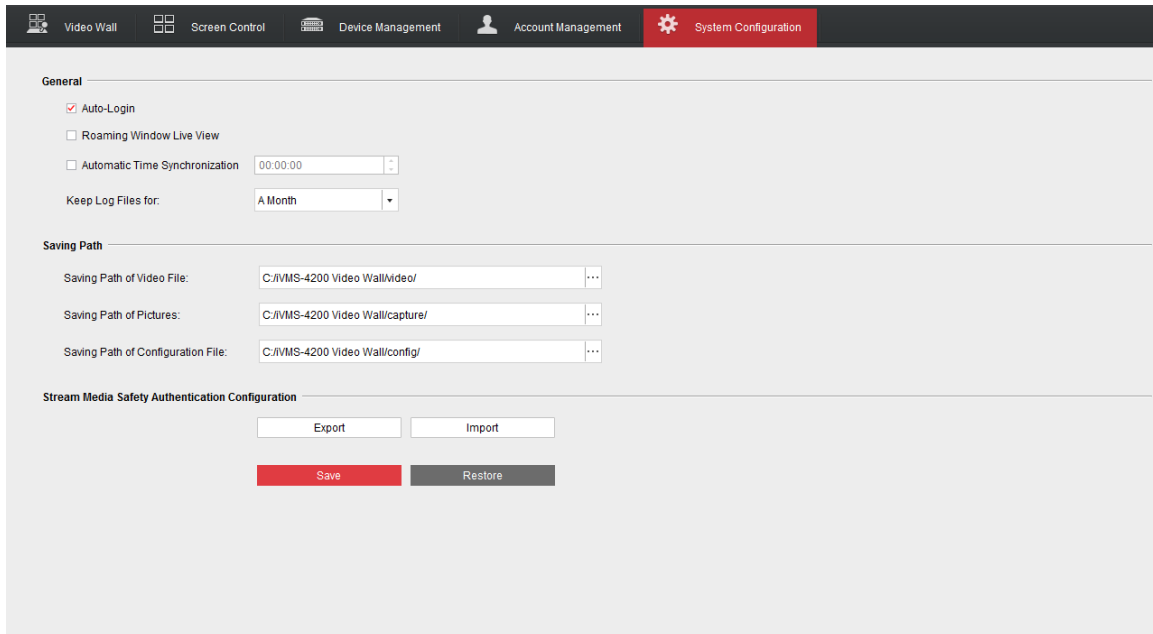

Figure 4-92 Export Stream Media Safety Authentication Configuration

Step 3 Import the stream media safety authentication configuration to the stream media server.

- 1) Run the stream media server.
- 2) Click **Configuration**.
- 3) Click **Import** to import the stream media safety authentication configuration to the server.

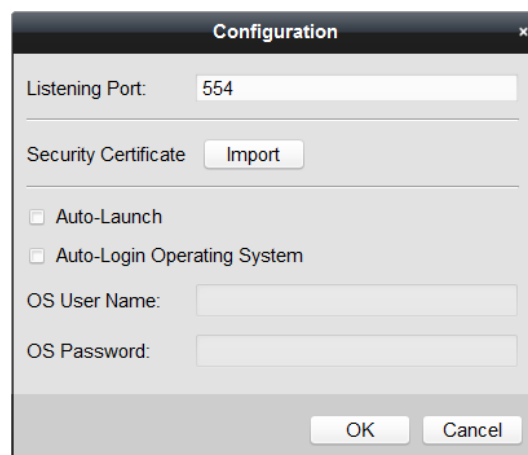

Figure 4-93 Import Stream Media Safety Authentication Configuration

- 4) Reboot the server to take the settings into effect.

Step 4 Import the stream media safety authentication configuration to the video wall controller via iVMS-4200 video wall client software.

- 1) Add the video wall controller to the iVMS-4200 video wall client software. Refer to *Chapter 3.2.2 Adding the Video Wall Controller* for details.
- 2) Click **Remote Configuration**.
- 3) Go to **System > Token Key**.
- 4) Check **Enable Token Authentication**.
- 5) Click **Import Token Authentication Information** to import the XML file exported to the local PC before. After import, the key content will generate in **Key** text filed.
- 6) Select **Not Fill** for **Encryption Algorithm Filling Format**.
- 7) Click **Save** to save the settings.



NOTE

For the other parameters of token configuration, remain the default settings.

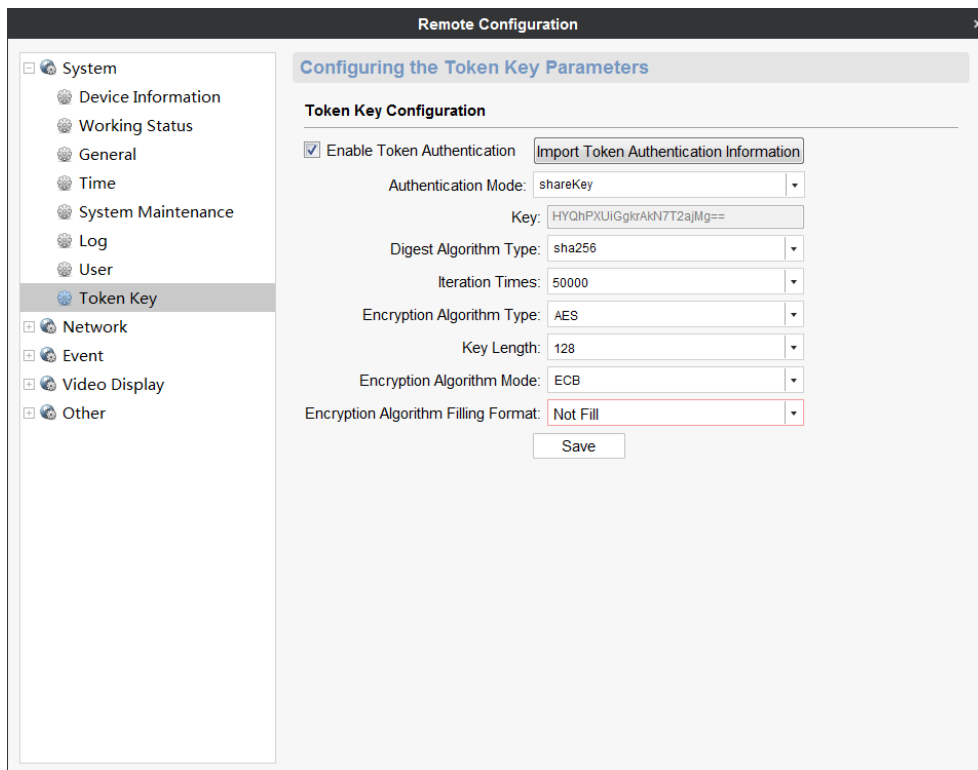

Figure 4-94 Token Configuration

Step 5 Select the added stream media and click **SMS Settings** on **Device Management** interface to set stream media server.

- 1) Check the groups or channels needing to get stream via stream media.

2) Click **OK** to save the settings.

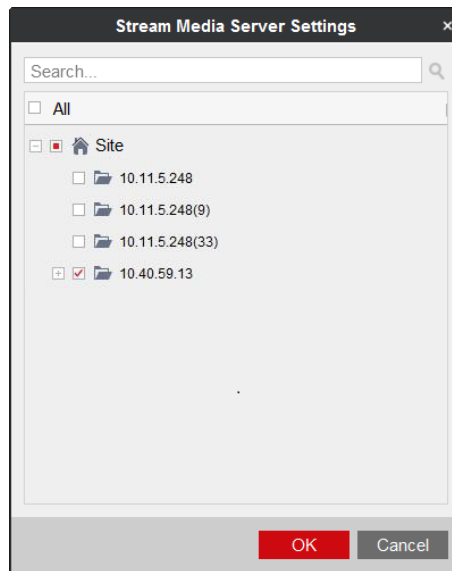

Figure 4-95 Stream Media Server Settings

Result: The groups or channels getting stream via stream media will get stream again via stream media. Open the stream media server, and the channels getting stream via stream media will be displayed.

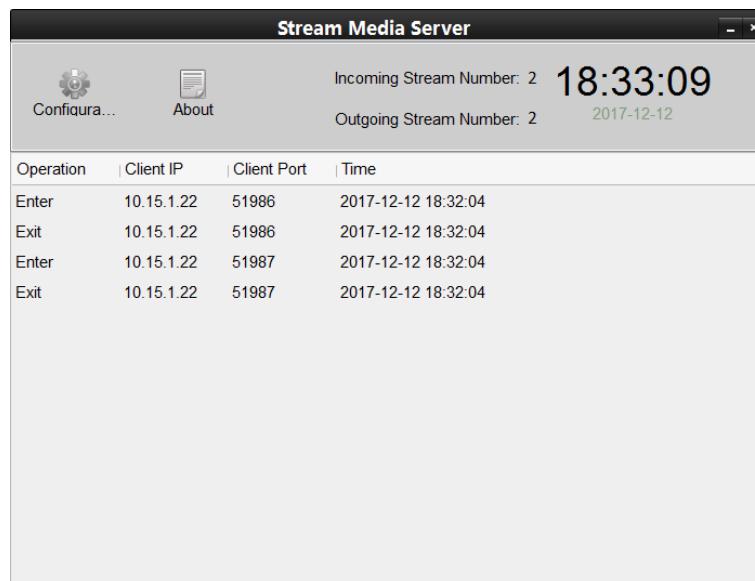

Figure 4-96 Stream Media Status

Chapter 5 Searching Logs

Purpose

The client log files of the controller can be searched. The log files are stored in the local computer.

5.1 Searching Log Files

Step 1 Click the **Log Search** item in the dropdown list of **Tool**.

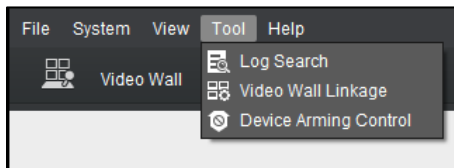

Figure 5-1 Dropdown List of Tool

Step 2 Specify the **Start Time** and **End Time**.

Step 3 Click **Search**. The log files meeting the conditions will be displayed on the list. You can check the **Operation Time**, **Description** and other information of the logs.

Operation Time	User Name	Log Type	Description	Device Name	Device Type	Group Name	Object Name	Objc
2016-05-16 09:52:13	admin	Operation Log	Start Roam Pr...		Centralized VI...		No Live View I...	Roar
2016-05-16 09:52:13	admin	Operation Log	DynamicDeco...	Video Wall Co...	Centralized VI...		L_1_Board1	Slgn
2016-05-16 09:52:13	admin	Operation Log	Start Dynamic ...	Video Wall Co...	Centralized VI...		L_1_Board1	Slgn
2016-05-16 09:52:13	admin	Operation Log	Open Roamin...		Centralized VI...		Video Wall Co...	Roar
2016-05-16 09:26:35	admin	Operation Log	Modify Video ...				Video Wall 2	Vide
2016-05-16 09:26:27	admin	Operation Log	Video Wall Co...	Video Wall Co...	Centralized VI...		DVI_Board1_4	Vide
2016-05-16 09:26:26	admin	Operation Log	Video Wall Co...	Video Wall Co...	Centralized VI...		DVI_Board1_4	Vide
2016-05-16 09:26:06	admin	Operation Log	Video Wall Co...	Video Wall Co...	Centralized VI...		DVI_Board1_4	Vide
2016-05-16 09:26:06	admin	Operation Log	Video Wall Co...	Video Wall Co...	Centralized VI...		DVI_Board1_4	Vide
2016-05-16 09:23:56	admin	System Log	User Login					

Figure 5-2 Searched Logs

5.2 Filtering Log Files

Purpose

The searching results (log files) can be filtered by the keyword or condition, and thus you can find the logs you want.

Step 1 Click **Log Filter** on the **Log Search** interface to expand the **Log Filter** panel.

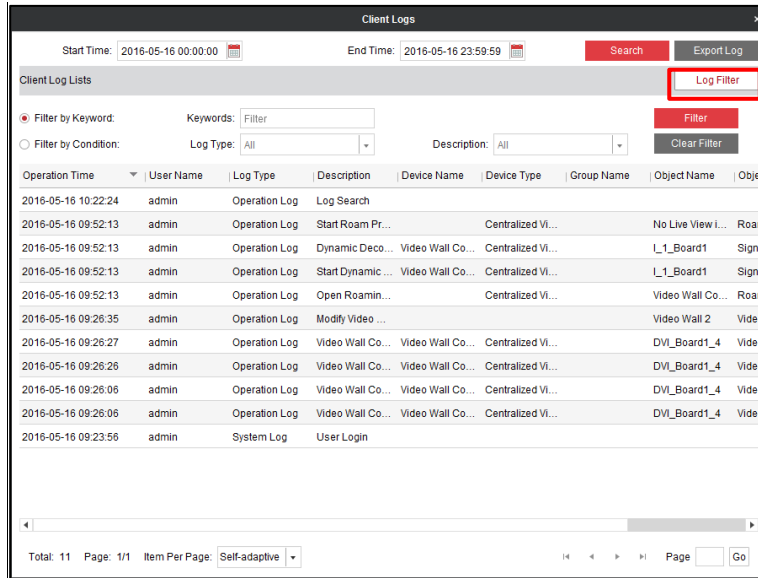

Figure 5-3 Log Filter

Step 2 Select the radio button of **Filter by Keyword**, and then input keyword for filtering in the text field.

Or select the radio button of Filter by Condition, and then specify Log Type and Description in the corresponding dropdown list.

Step 3 Click **Filter** to start filtering. You can click **Clear Filter** to clear the filtering.

5.3 Exporting Log Files

Purpose

The log files, including the client logs and server logs, can be exported for backup.

Before you start

Search out the log files first.

Step 1 Click **Export Log** on the **Log Search** interface to open the **Log Backup** dialog box.

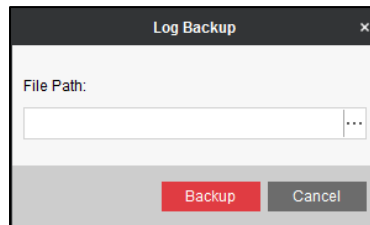



Figure 5-4 Log Backup

Step 2 Click the icon  and select a local saving path.

Step 3 Click **Backup** to export the log files.

Chapter 6 Accessing via Web Client

You can control and manage the DS-C10S series video wall controller via the Web client. It provides multiple functions, including adding cameras, displaying signals on the video wall, managing scene and plan, etc.

6.1 Login

Enter the IP address of the device in the address bar of your Web browser to go to the login interface. Enter the user name and password to enter the Web management page.

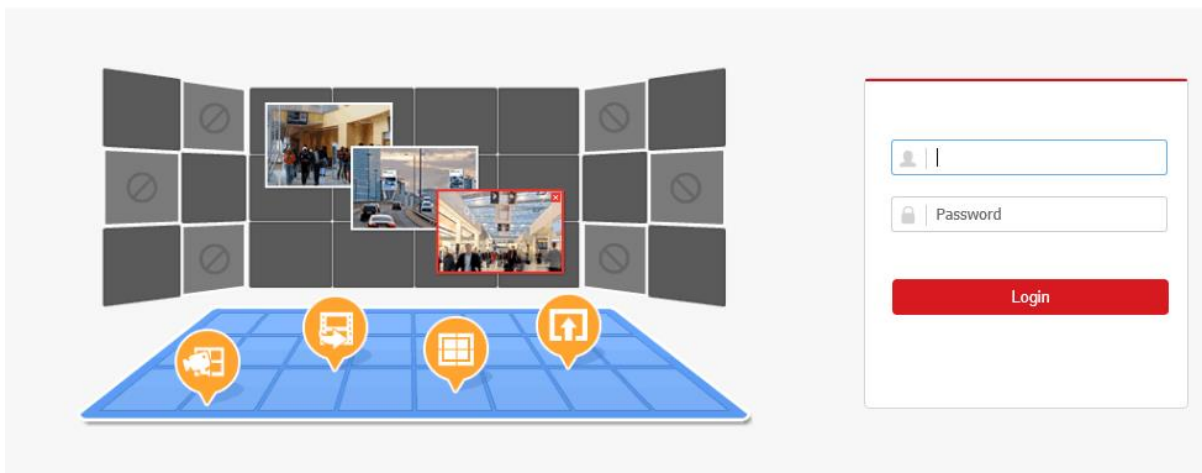

Figure 6-1 Device Login Page

6.2 Configuring Encoding Devices

6.2.1 Adding an Encoding Device

Purpose

You can add an encoding device via IP address.

Step 1 Click **IP** to add encoding devices.

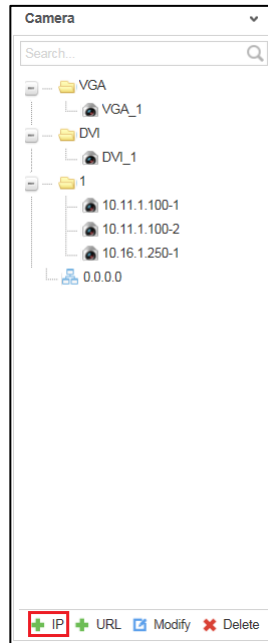

Figure 6-2 Encoding Device List



Step 2 Input **Device Name, Type, Port, User Name, Password** and **Channel Number** and select the **Transmission Protocol, Area Name, and Device Manufacturer**. Check the checkbox of **Get Stream by Stream Media** to lower the network load of the device.

The screenshot shows a dialog box titled "Add" with a close button (X) in the top right corner. The dialog contains the following fields and options:

- Device Name: Text input field containing "Device 1" with a green checkmark to its right.
- IP Address: Text input field containing "192.168.1.22" with a green checkmark to its right.
- Port: Text input field containing "80" with a green checkmark to its right.
- User Name: Text input field containing "admin" with a green checkmark to its right.
- Password: Password input field with 10 dots and a green checkmark to its right.
- Transmission Protocol: Dropdown menu showing "TCP".
- Stream Type: Dropdown menu showing "Main Stream".
- Area Name: Dropdown menu with a green plus sign (+) to its right.
- Device Manufacturer: Dropdown menu showing "HIKVISION".
- Camera Type: Dropdown menu showing "NORMAL".
- Channel Number: Empty text input field.
- Get Stream by Streammedia
- Streammedia IP Address: Disabled text input field.
- Port: Disabled text input field.
- Transmission Protocol: Disabled dropdown menu showing "TCP".

At the bottom right of the dialog, there are two buttons: "Next" and "Cancel".

Figure 6-3 Add Device via IP Address

Step 3 (Optional) You can also click  to add a new area and click  to save the area.

Step 4 Click **Next** to select the channel. The channel(s) displayed here depend(s) on the **Channel Number** you input on the previous page.

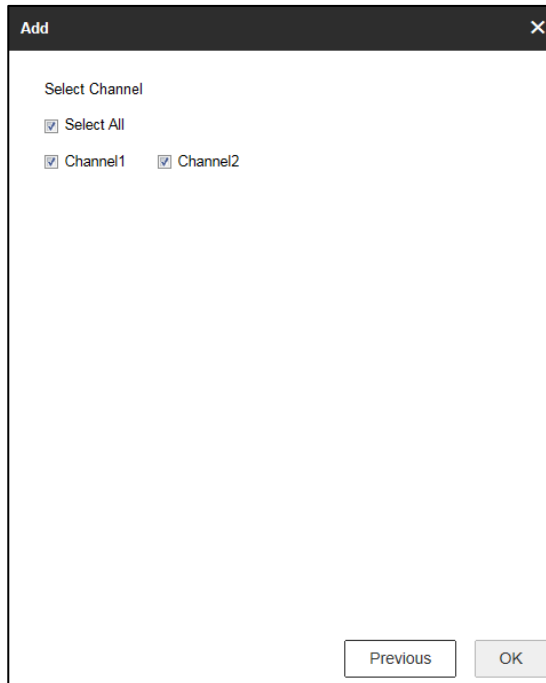

Figure 6-4 Select the Channel

Step 5 Click **OK** to save the settings and add the device.

6.2.2 Modifying an Encoding Device

Step 1 Select one area or one encoding device, and click **Modify** to modify corresponding parameters.

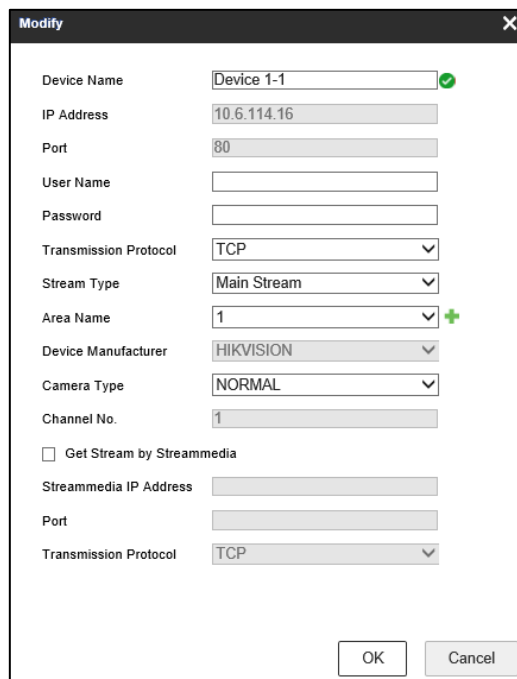

Figure 6-5 Modify Encoding Device

Step 2 Click **OK** to save the new settings.

6.2.3 Deleting an Encoding Device

Step 1 Select one area or one encoding device and click **Delete** to pop up the note interface below.

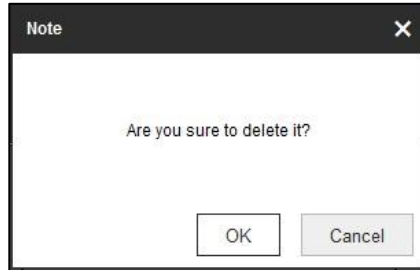

Figure 6-6 Deleting Note

Step 2 Click **OK** to delete it.

6.3 Configuring Video Wall

Purpose

To realize the display of the decoded video on the video wall, you must set the video wall configuration first so as to link the video output with video wall.

Step 1 Click **Video Wall Configuration** to enter the corresponding interface.



Figure 6-7 Video Wall Configuration

Step 2 You can use the default video wall layout or click  to add a new layout. Input the number of screens in row and column and up to 16 × 20 split screens are available.

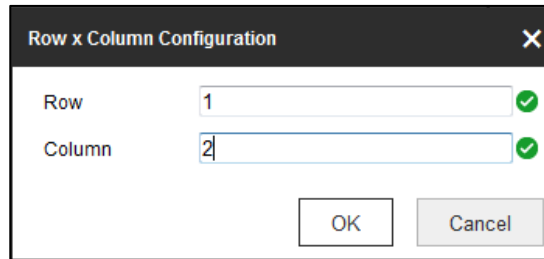



Figure 6-8 Screen Layout Configuration

Step 3 Click **OK** to finish the adding of the video wall information.

Step 4 Drag the output channels from the left-side list to the display screen.

Step 5 Move the cursor to the window, and the icon  automatically appears in the upper-right corner of the window. Click  to close the window.

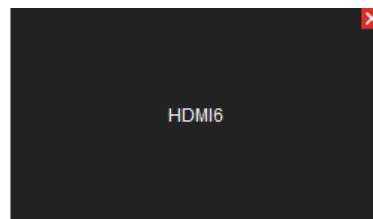

Figure 6-9 Close the Window

6.4 Configuring Decoding Output

Purpose

In the output list, you can configure the resolution of the decoding outputs.

Step 1 Click **Video Wall Configuration** to enter the corresponding interface.

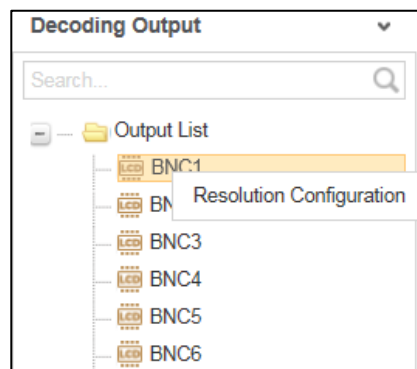

Figure 6-10 Decoding Output

Step 2 Right click one of the decoding output and select **Resolution Configuration** to pop up the interface as below.

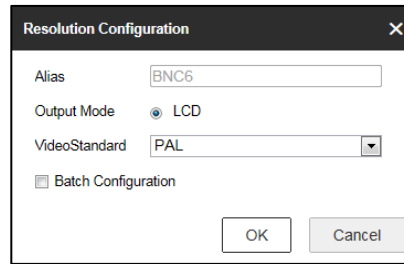

Figure 6-11 Resolution Configuration

Step 3 Select the resolution from the **LCD Resolution** drop-down list. PAL and NTSC are selectable.

Step 4 Check the checkbox of **Batch Configuration** to set the same configuration for other outputs with same signal source.

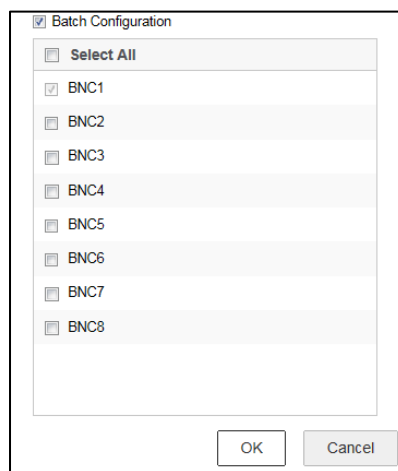

Figure 6-12 Batch Configuration

Step 5 Click **OK** to save the settings.

6.5 Decoding Video on Video Wall

Purpose

You can decode the video of the encoding devices on the video wall by dragging the channel directly or opening window via coordinate.

6.5.1 Interface Description

Click **Video Wall** to enter the video wall interface.

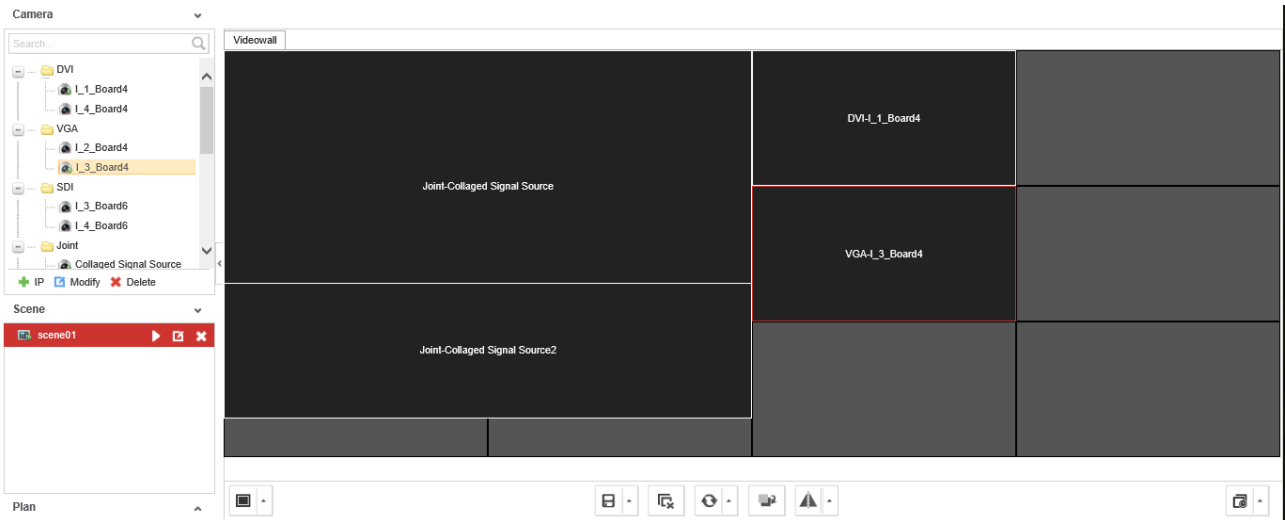









Figure 6-13 Video Wall Interface

Refer to the following figure for the video wall description.

Table 6-1 Description of Video Wall

Area	Description
Camera	Encoding Device List: The encoding devices added in the Web
Scene	The Web supports up to 8 scenes by default, capable of independent scene configuration and fast switching.
Video Wall:	Video wall operation interface
Shortcut Toolbar	 Select decoding screen layout.  Save the scene  Delete all windows  Refresh all windows  If two decoding windows overlap with each other, click the icon to switch the upper window to the bottom.  Mirror the current video wall, that is, copy the current video wall to the other video wall with the layout and content.  Remotely open or close all the screens.

6.5.2 Dragging Channels to the Video Wall

Step 1 Drag the channel from the left side list to realize the decoding in the selected window.

You can also drag an area file to the video wall to decode the added encoding devices in the area file on the video wall.

 **NOTE**

- You cannot drag an area file to the video wall across the LCD and LED outputs.
- If there are more than 3 encoding devices in an area, when you drag the area file to the video wall, the note pops up to remind you that no more window can be opened or the

total area of layers in single-screen has reached the limit. Only the first 3 encoding devices in the area file can be decoded on the video wall.

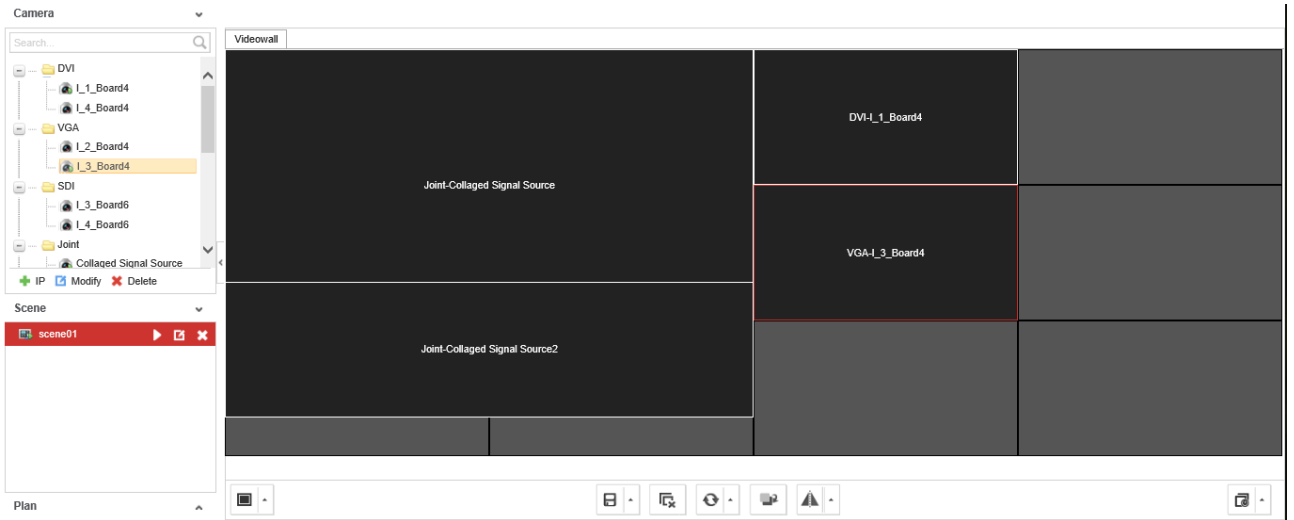

Figure 6-14 Decode the Video on the Wall

Step 2 Select one decoding window and click  to set the decoding screen layout.

1/2/4/6/8/9/12/16/25/36 window division modes are available.

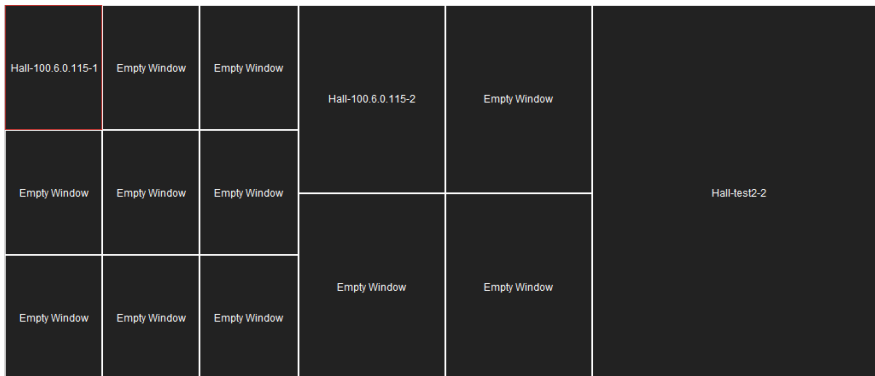

Figure 6-15 Window Division

6.5.3 Opening Window via Coordinate

Step 1 Select one encoding device and right-click it to pop up the interface below.

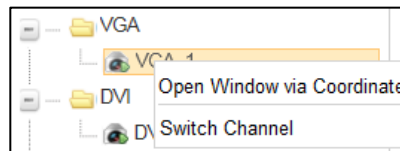

Figure 6-16 Right-Click Menu

Step 2 Click **Open Window via Coordinate**.

Step 3 Select the **Window Opening Mode**. LCD and LED are selectable.

- **Opening Window via Coordinate for LCD Output**

- 1) Select the **Window Opening Mode** as **LCD**.
- 2) Enter the **Left Margin**, **Right Margin**, **Width** and **Height** in the corresponding text fields.
- 3) Click **OK** to save the settings.

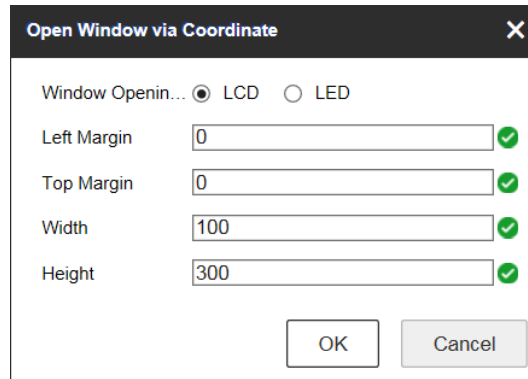

Figure 6-17 Open Window via Coordinate for LCD Output

- 4) The window will be opened in the LCD area.

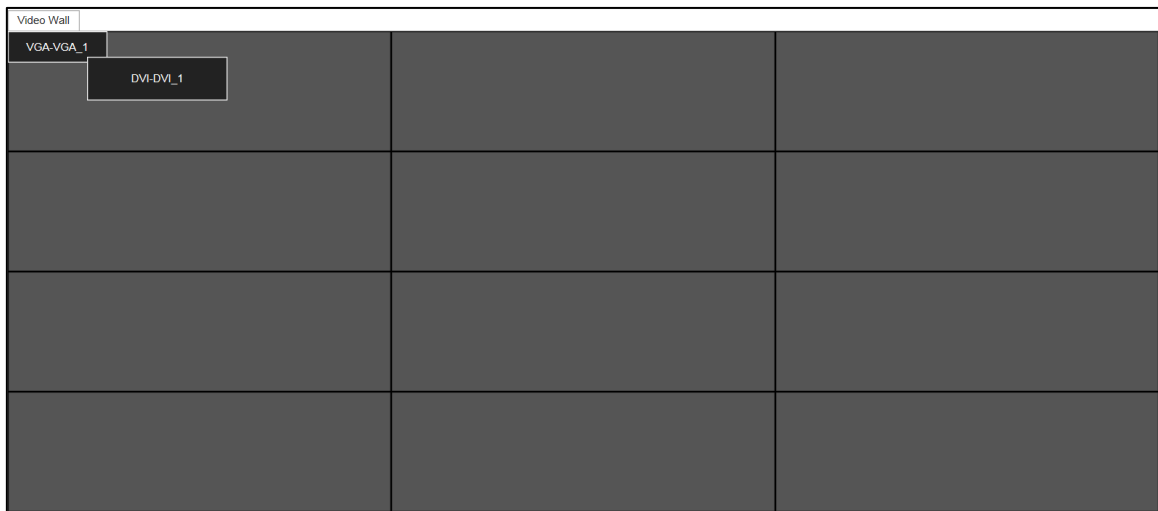

Figure 6-18 Window Opened in LCD Area

- **Opening Window via Coordinate for LED Output**

- 1) Select the **Window Opening Mode** as **LED**.
- 2) Select the **LED** area.

The area number depends on the HDMI decoding output configuration. For the adjacent HDMI outputs, if the resolution is configured to be LED, and the LED width or height is same, they can be seen as one area. You can refer to *Chapter 6.3.2 Configuring HDMI Output*.

- 3) Enter the **Left Margin**, **Right Margin**, **Width** and **Height** in the corresponding text fields.
- 4) Click **OK** to save the settings.

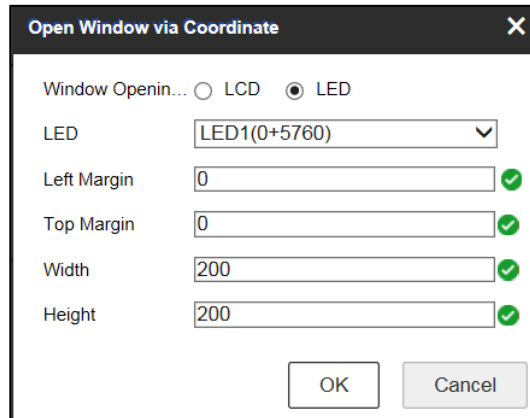

Figure 6-19 Open Window via Coordinate for LED Output

- 5) The window will be opened in the LED area.

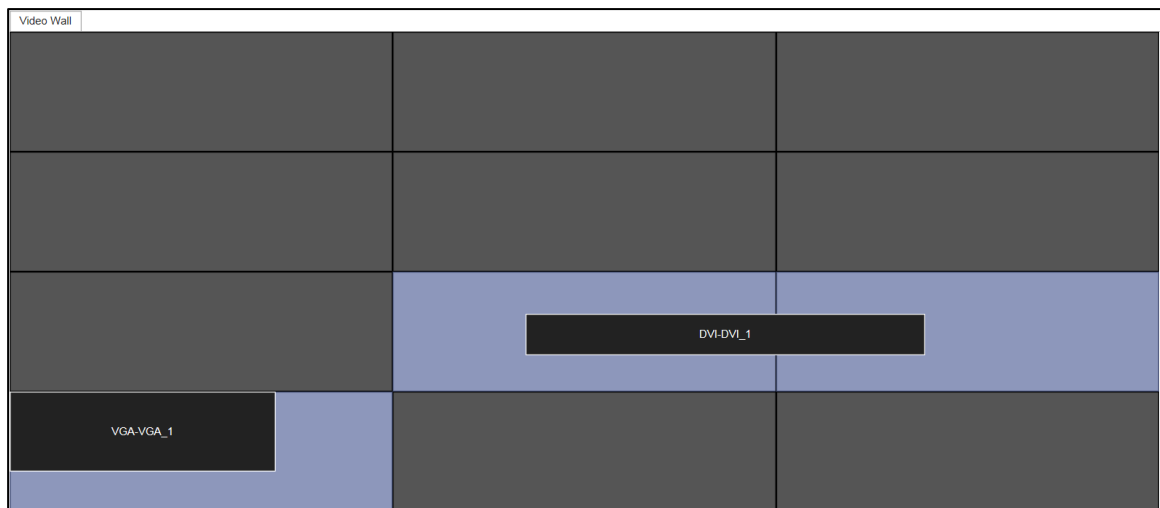

Figure 6-20 Window Opened in LED Area

6.5.4 Managing Decoding

Right-click the selected window and the Decoding Management interface pops up.

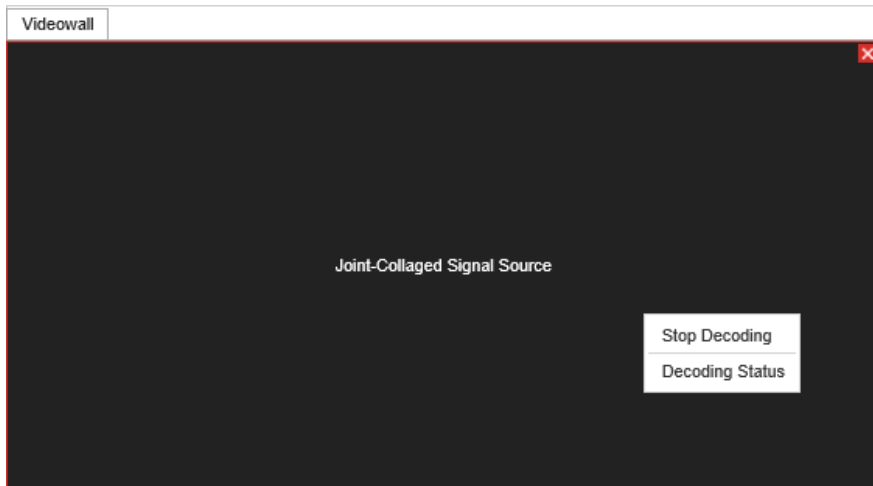

Figure 6-21 Decoding Management

● **Stop Decoding**

Click the button to stop decoding.

● **Decoding Status**

1. Click the button to enter the decoding status interface.
2. View the decoding status.

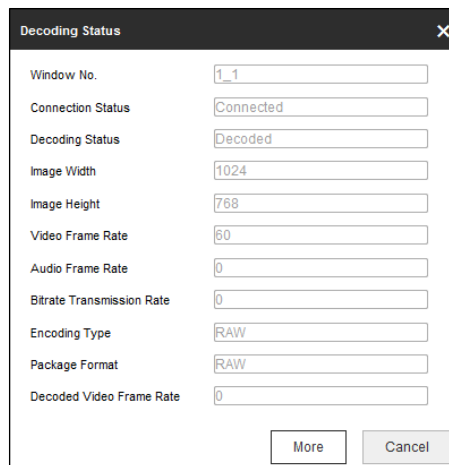

Figure 6-22 Decoding Status

3. Click **More** to check the decoding information of each channel.

Window.	Connection Status	Decoding Status	Image Width	Image Height	Video Frame Rate	Audio Frame Rate	Bitrate Transmission...	Encoding Type	Package Format	Decoded Video Fram...
1_1	Connected	Decoded	1280	720	59	0	0	RAW	RAW	10864
2_1	Connected	Decoded	1280	720	59	0	0	RAW	RAW	10446
3_1	Not connected	Not decoded	0	0	0	0	0	UNKNOWN	UNKNOWN	0
4_1	Not connected	Not decoded	0	0	0	0	0	UNKNOWN	UNKNOWN	0

Figure 6-23 Check More Decoding Status Information

6.5.5 Switching Encoding Channel

Purpose

You can switch the encoding channel to display on the selected decoding window.

Step 1 Select a decoding window and select an encoding channel from the left side list.

Step 2 Click **Switch Channel** from the right-click menu to switch the selected channel to the decoding window.

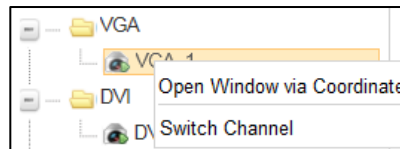

Figure 6-24 Right-Click Menu

6.5.6 Configuring Auto-Switch of Cameras

Purpose

You can enable auto-switch of the added cameras in one area.

Step 1 Select a camera area and click **Start Auto-Switch** from the right-click menu.

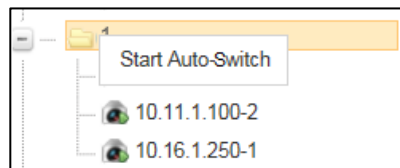

Figure 6-25 Right-Click Menu

Step 2 On the Start Auto-Switch interface, input the **Interval** for auto-switch.

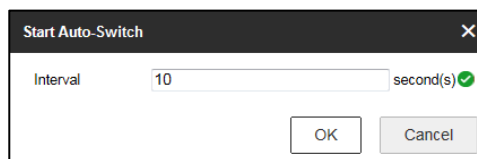

Figure 6-26 Start Auto-Switch

Step 3 Click **OK** to save the settings.

6.5.7 Roaming Window

Step 1 Drag one camera from the left side list to the video wall layout to enable decoding in the corresponding window automatically.

Step 2 Drag the decoding window randomly to realize the window roaming on the video wall.



Figure 6-27 Window Roaming

Step 3 Select one of the roaming windows, and click  to realize window division in the selected roaming window with 1/2/4/6/8/9/12/16/25/36 available.

Step 4 (Optional) Generally the selected window is at top by default. Click  to place the selected window at bottom.

 **NOTE**

- Roaming and fluent video cannot be realized in the window with the signal output via BNC interfaces.
- The roaming window cannot cross the output window of different resolution. For example, you cannot move the roaming window across the LCD and LED window.

6.5.8 Zooming in/out Roaming Windows

Purpose

You can double click the roaming window to zoom in or out.

- **For one roaming window:**

Step 1 Double click the roaming window to zoom in. Then the window will occupy the area with the same output.

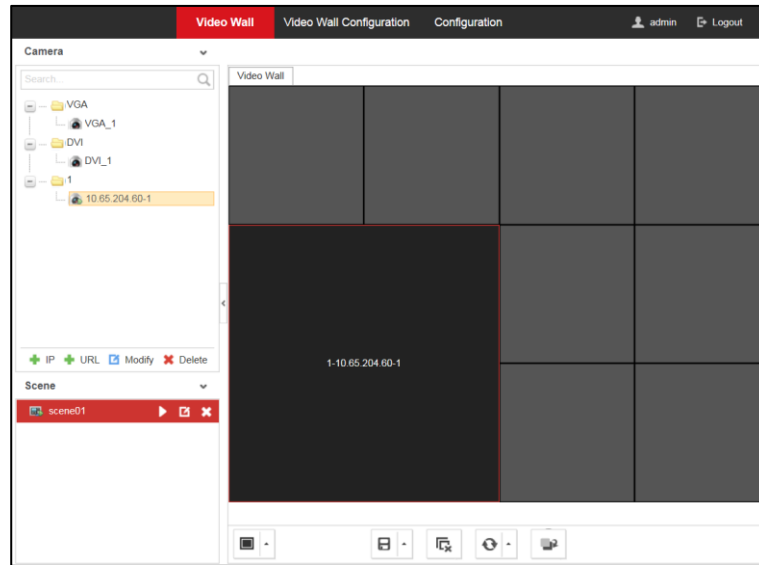

Figure 6-28 Zoom in

Step 2 Double click the window again to zoom out. Then the window will restore to the original size.

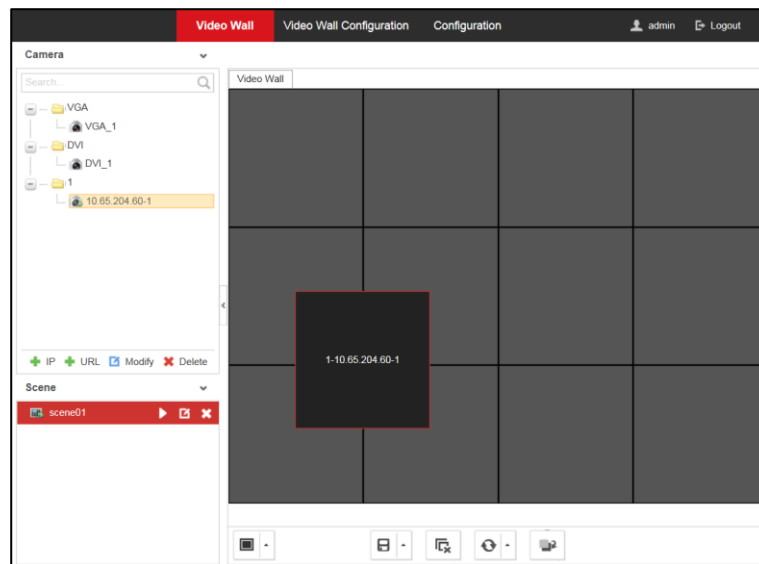

Figure 6-29 Zoom out

- **For divided roaming sub-window:**

Step 3 Double click the divided roaming sub-window to zoom in. Then the sub-window will occupy the whole window before being divided.

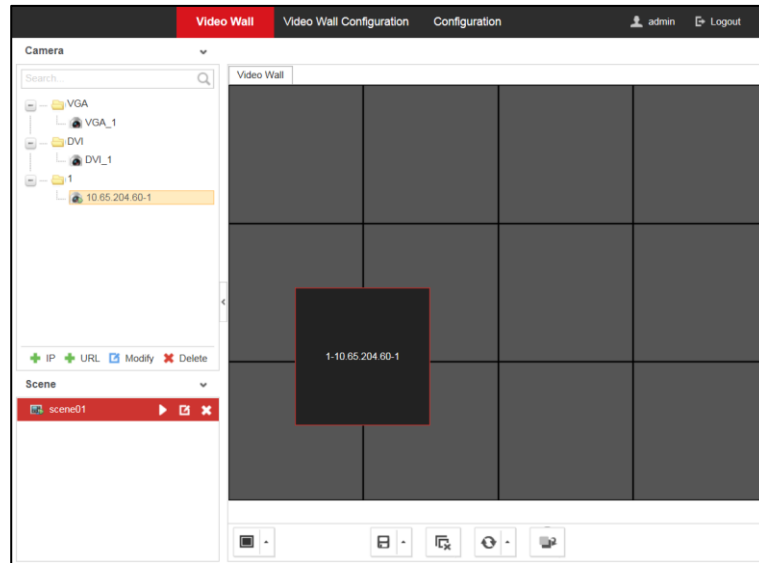

Figure 6-30 Zoom in

Step 4 Double click the divided roaming sub-window again to zoom out. Then the sub-window will restore to the original size.

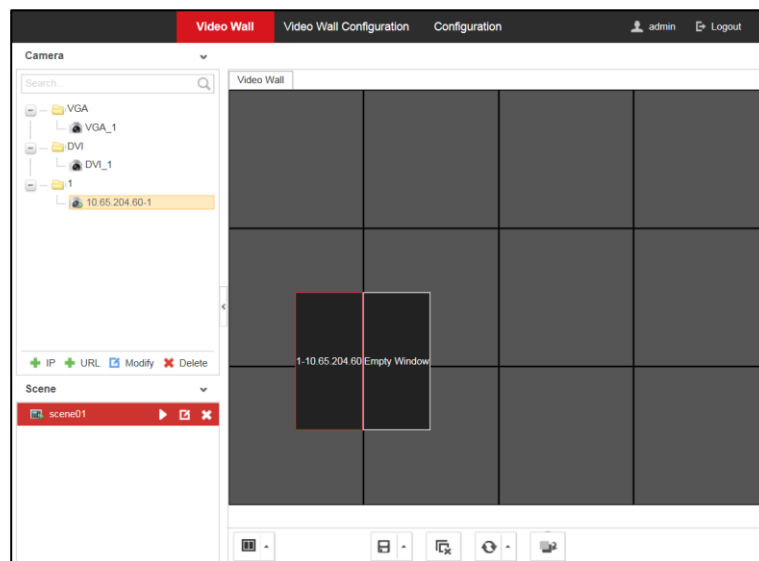

Figure 6-31 Zoom out

6.5.9 Configuring Scene

Purpose

Different video wall layouts can be saved as different scenes and up to 8 scenes can be added. You can easily view the required live videos on the video wall by calling the scene.

Step 1 In the Video Wall interface drag the channel from the left side list to realize the decoding in the selected window.

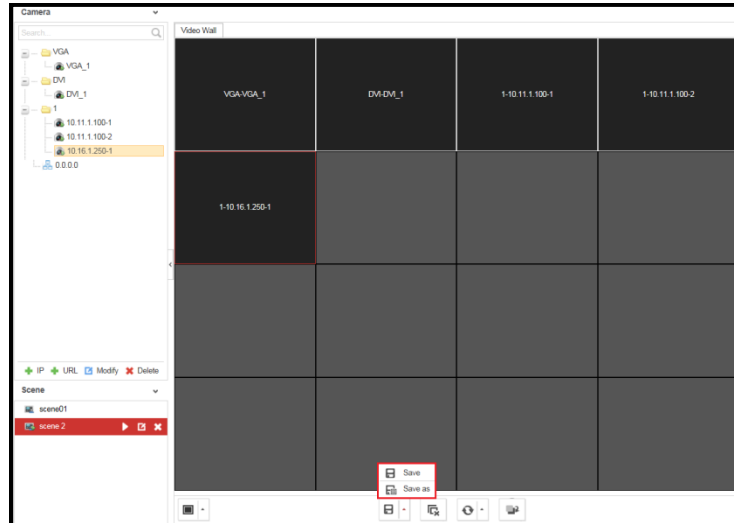

Figure 6-32 Save the Scene

Step 2 Click **Save** to save the scene directly or click **Save as** to pop up the following dialog box.

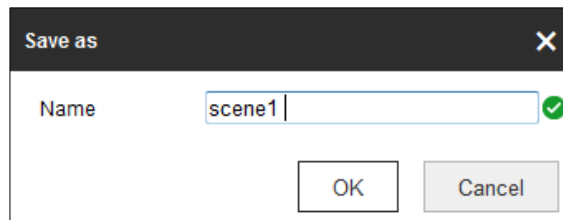

Figure 6-33 Save as Interface

Step 3 Input the **Name** and click **OK** to save the scene.

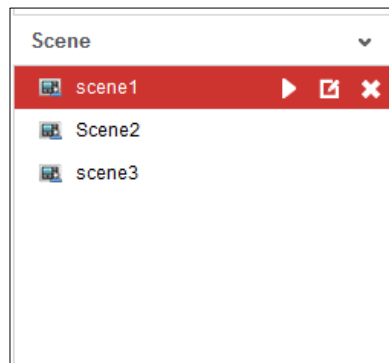





Figure 6-34 Scene List

Step 4 Select one of the scenes you have configured. Click  to call the scene.

Step 5 (Optional) You can also click  to rename the scene, or click  to delete the scene.

6.6 Configuration

6.6.1 System Configuration

Checking Device Information

Purpose

You can check the information of the device in the device information interface, such as the Physical Address, Device Type, Device Serial No., Firmware Version, Decoding Version, Web Version, Plugin Version, etc., and modify the Device Name.

Step 1 Click **Configuration > System > System Settings > Basic Information**.

Step 2 (Optional) Modify **Device Name**.

Step 3 View other device information.



The description about the decoder configuration and operation by web browser below is based on the firmware, decoding, web and plugin version shown in the following figure.

Basic Information	RS-232
Device Name	<input type="text" value="Video Controller"/>
Physical Address	<input type="text" value="8c:e7:48:9b:c3:e3"/>
Device Type	<input type="text" value="DS-C10S-TI"/>
Device Serial No.	<input type="text" value="DS-C10S-TI3220170901AARR827191855"/>
Firmware Version	<input type="text" value="V1.6.1 build 191225"/>
Decoding Version	<input type="text" value="V1.3 build 000000"/>
Web Version	<input type="text" value="V4.1.1 build 191225"/>
Plugin Version	<input type="text" value="V3.0.5.40"/>

Figure 6-35 Check Device Information

Configuring RS-232 Serial Port

Step 1 Click **Configuration > System Settings > RS-232** to enter the following interface:

Basic Information	RS-232
RS-232 Port	2
Duplex	Half-duplex
Baud Rate	115200
Data Bit	8
Stop Bit	1
Parity	None
Flow Control	None
Working Mode	Screen Control
Changeable	Yes
Serial Port Protocol	



Figure 6-36 Configure RS-232 Settings

Step 2 Configure the RS-232 parameters, including the baud rate, data bit, stop bit and parity type.

Step 3 Select the Working Mode of RS-232 as Screen Control, Matrix Control, Keyboard Control or PTZ Control based on the actual requirements.

Step 4 Click **Save** to save the settings.

6.6.2 Security Service Configuration

Click **Configuration > Security Control** to enable or disable SSH, Https, or SADP services based on your actual requirements.

Security Service

enabled SSH

enabled Https

enabled SADP



Figure 6-37 Security Service Configuration

6.6.3 Network Configuration

Click **Configuration** > **Network** to configure device TCP/IP parameters, port parameters, and sub-board parameters based on your actual requirements.

TCP/IP	Port	Sub-board
IPv4 Address	<input type="text" value="10.65.82.80"/>	
IPv4 Subnet Mask	<input type="text" value="255.255.255.0"/>	
IPv4 Gateway	<input type="text" value="192.168.1.22"/>	
Preferred DNS Server	<input type="text" value="0.0.0.0"/>	
Alternate DNS Server	<input type="text" value="0.0.0.0"/>	
NIC Type	<input type="text" value="1000 M with Full Duplex"/>	



Figure 6-38 Network Configuration

6.6.4 System Maintenance

Purpose

You can click **Configuration** > **System** > **Maintenance** to perform reboot, upgrade, and default restoration operations.

Upgrading the Device

Step 1 Enter the Upgrade interface.

Step 2 Click **Browse** to search the upgrading files.

Step 3 Click **Upgrade** to upgrade it.

Upgrade

Firmware

Figure 6-39 Upgrade the Device

 **NOTE**

- When logging in to the device for the first time, install the plug-in according to the prompt on the screen.
- The device will restart after completing the upgrade.

Restoring the Default Settings

Step 4 Enter the Default Settings interface.

Step 5 Click **Default** to restore the completed factory settings of the decoder.

Or click **Restore** to restore a part of the factory settings of the decoder.

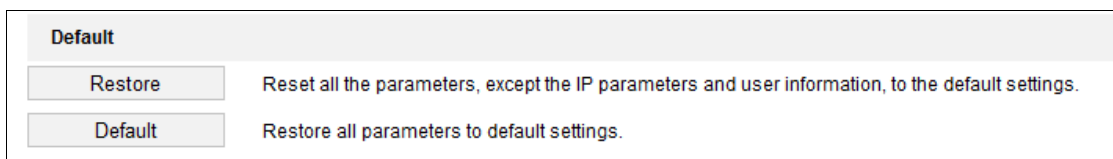

Figure 6-40 Restore Default Settings

Rebooting the Device

Step 6 Enter the Reboot Device interface.

Step 7 Click **Reboot** to reboot the device.



Figure 6-41 Reboot the Device

Chapter 7 Accessing via iVMS-4510 HD Client Software

You can operate the video wall controller via iVMS-4510 HD client software (hereinafter referred to as iVMS-4510 HD) that can be installed in iPad or Android tablet. It supports displaying signals on video wall, switching scenes, switching plans, etc. Before operating your controller in iVMS-4510 HD, you need to add cameras to your video wall controller via the web browser and configure video walls, scenes, and plans in iVMS-4510 HD client software.

NOTE

- Download iVMS-4510 HD in Google Play or APP Store.
- User interfaces of iVMS-4510 HD in iPad and Android tablet are mostly the same. In this chapter, we take the example of operating iVMS-4510 HD in Android tablet to describe the steps.

7.1 Login

Step 1 Run iVMS-4510 HD.

Step 2 Configure the server of your video wall controller.

- 1) Click .
- 2) Enter server IP **Address** and **Port**, and select **Screen** display mode.
- 3) Click **Save**.

Step 3 Enter **Password** of your video wall controller and click **Login**.

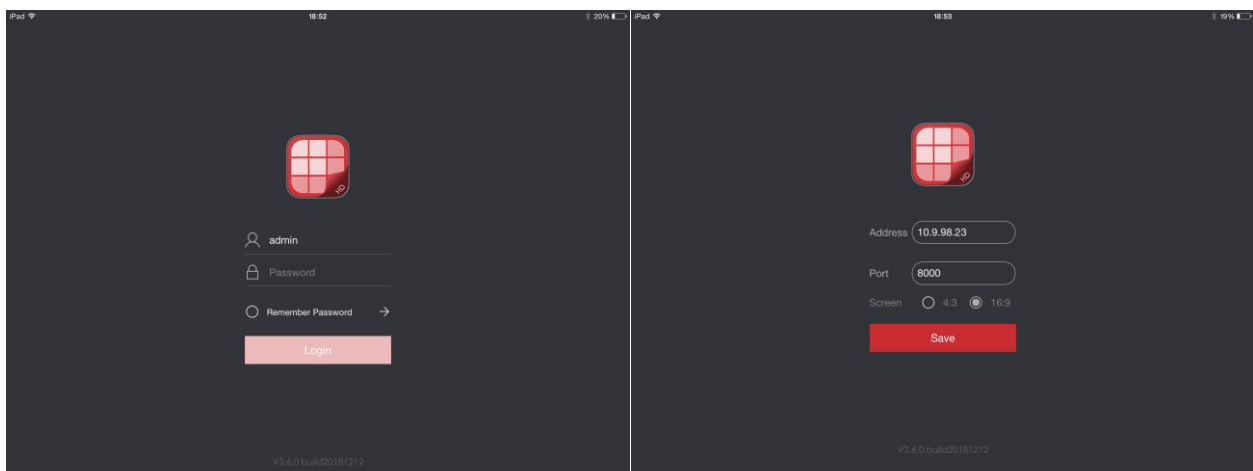

Figure 7-1 Login

7.2 Select the Video Wall

C10S-T series controller supports multiple video walls. All the video walls created in video wall client software will be shown in iVMS-4510 HD. You can select a video wall to configure as you desire.

7.3 Display Signals on the Video Wall

Before you start

Log into your controller via web browser and add signals. iVMS-4510 HD does not support adding signals.

You can see the video wall interface after logging into iVMS-4510 HD. To display signals on a video wall, hold a signal on the signal list for 1 second and drag it to an output on the right video wall.

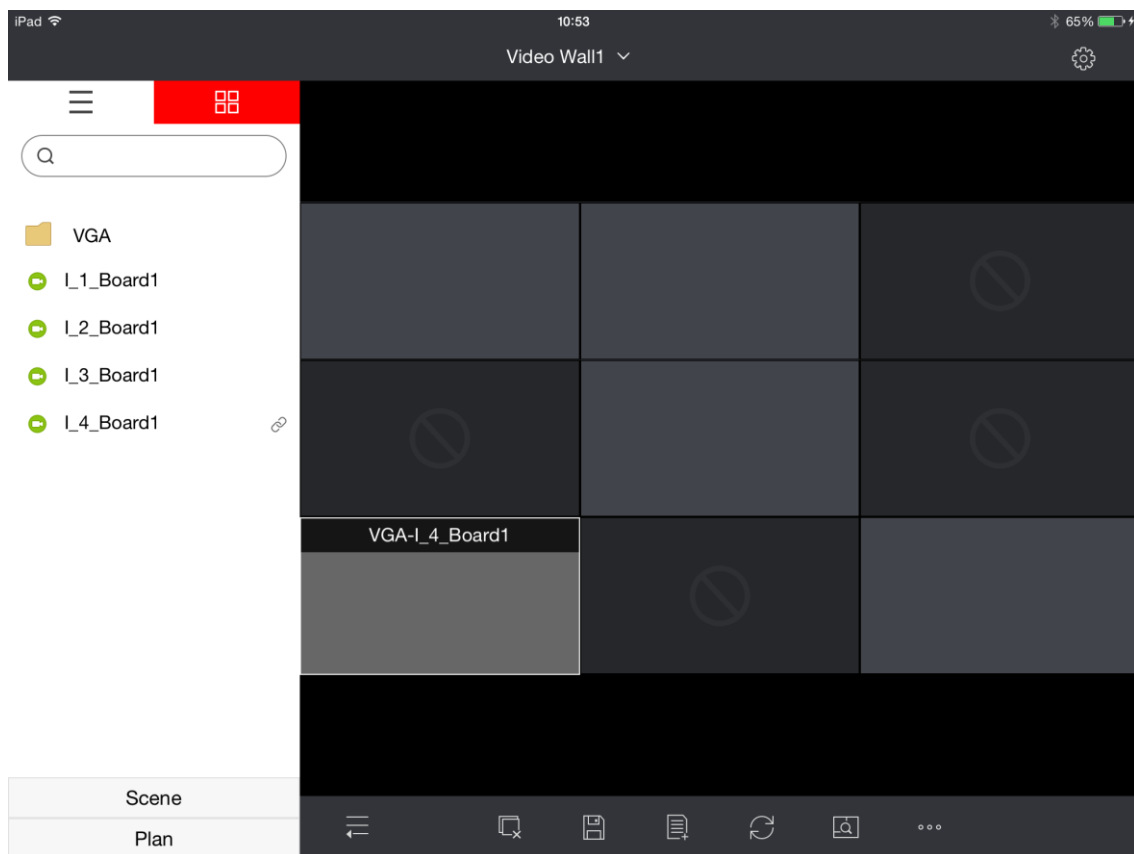

Figure 7-2 Display Signals on Video Wall

7.4 Window Operation

7.4.1 Resizing a Window

- Select a window and pinch fingers to make the window larger or smaller.

- When a window spans across multiple screens (as shown in Figure 7-3), double-click it. Then the window will overspread the screens it spans across (as shown in Figure 7-4).

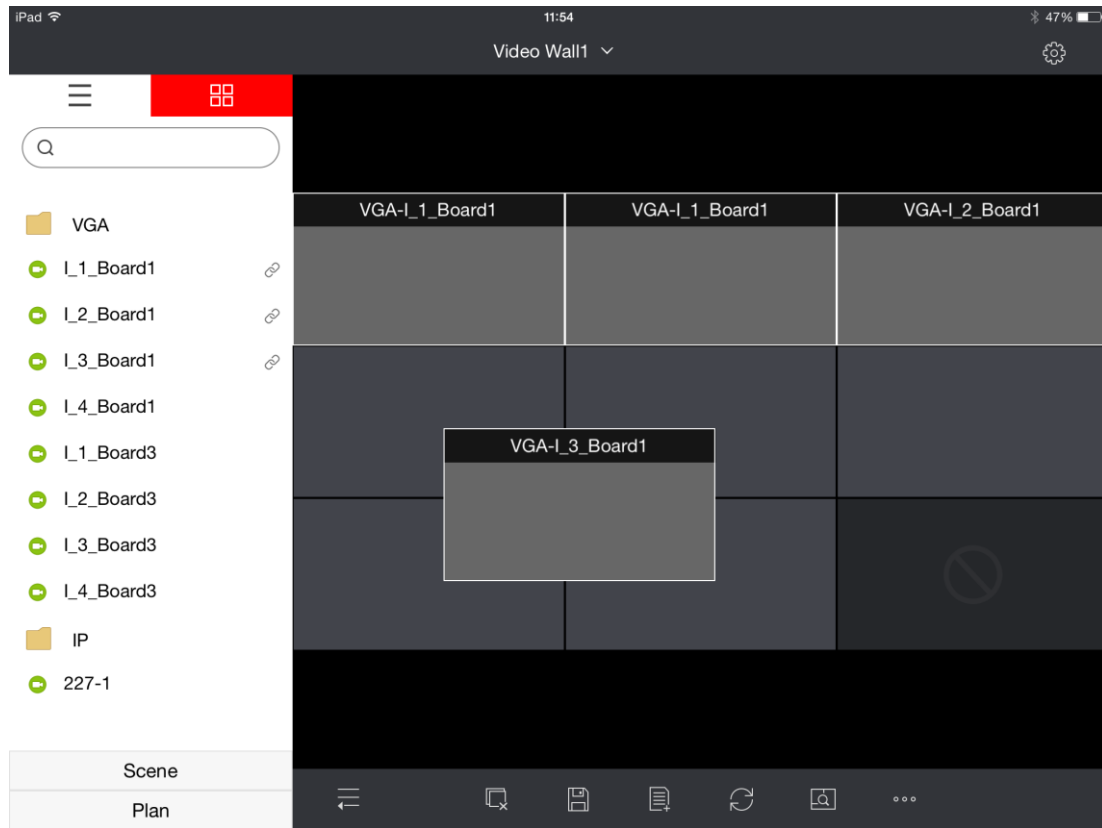

Figure 7-3 Enlarge a Window (1)

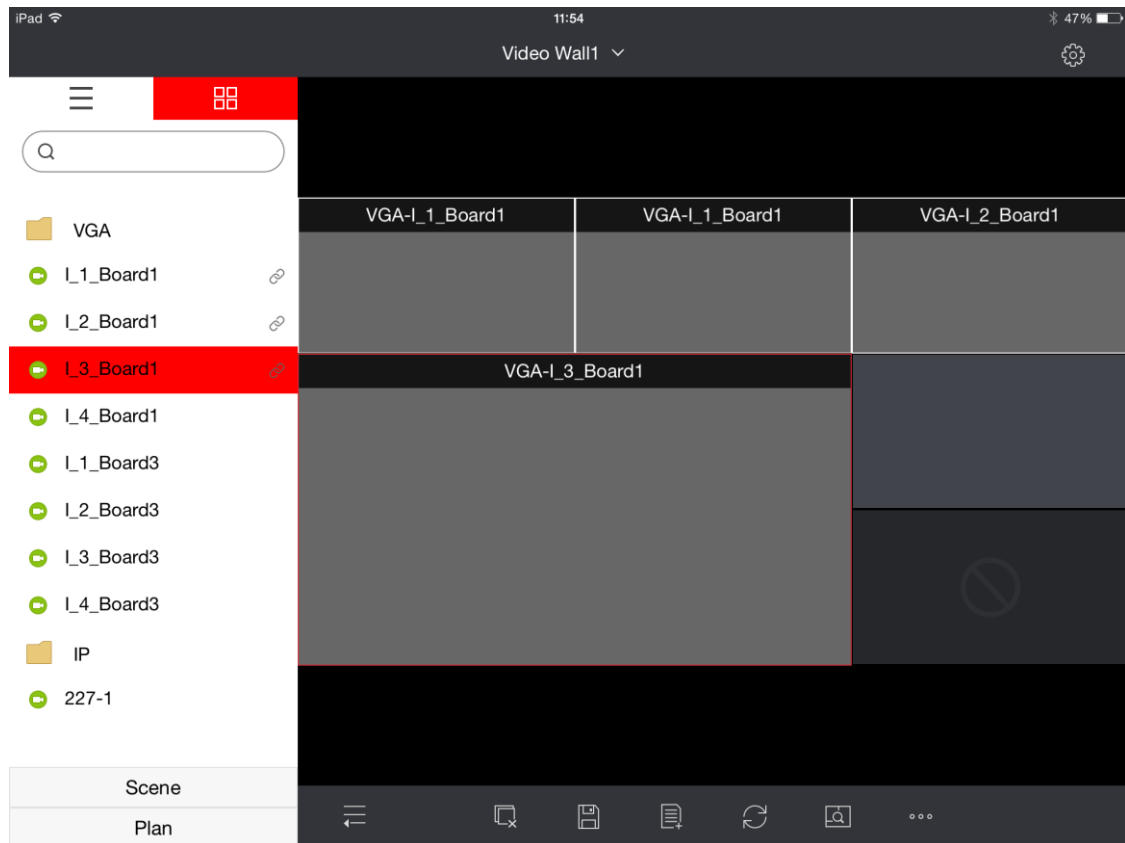

Figure 7-4 Enlarge a Window (2)

7.4.2 Window Roaming

Hold a window and drag it to any position on the video wall.

7.4.3 Stick a Window at Bottom

When windows overlap together, you can stick a window at the bottom of all the windows.

Hold a window till a menu pops up, and tap **Stick at Bottom**.

7.4.4 Divide a Window

Step 1 Hold a window till a menu pops up, and tap **Window Division**.

Step 2 Select window division as 1-screen, 4-screen, 9-screen, or 16-screen.

After dividing the window of a single screen, the image of the window will be shown in the first sub-window.

7.5 Smart Scaling on the Video Wall

If the video wall size is overlarge and is not convenient for iVMS-4510 HD operation, you can zoom in the screens on the video wall.

Step 1 Tap .

Step 2 Pinch fingers to adjust the size of the grey frame.

Step 3 Move the frame to the desired position. The screens within the frame will be zoomed in.

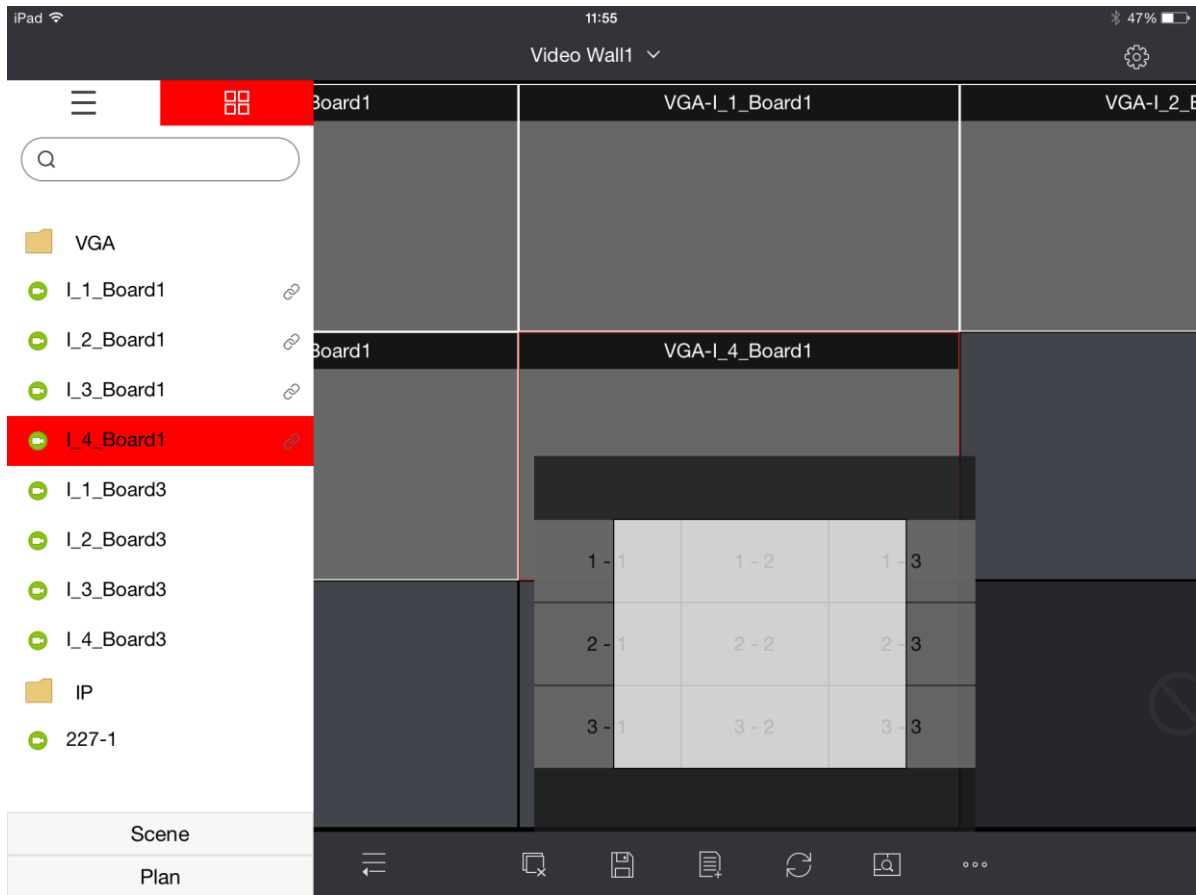



Figure 7-5 Resize Screens

7.6 Manage the Scene

7.6.1 Add a Scene

Tap , enter a scene name, and tap **OK**.

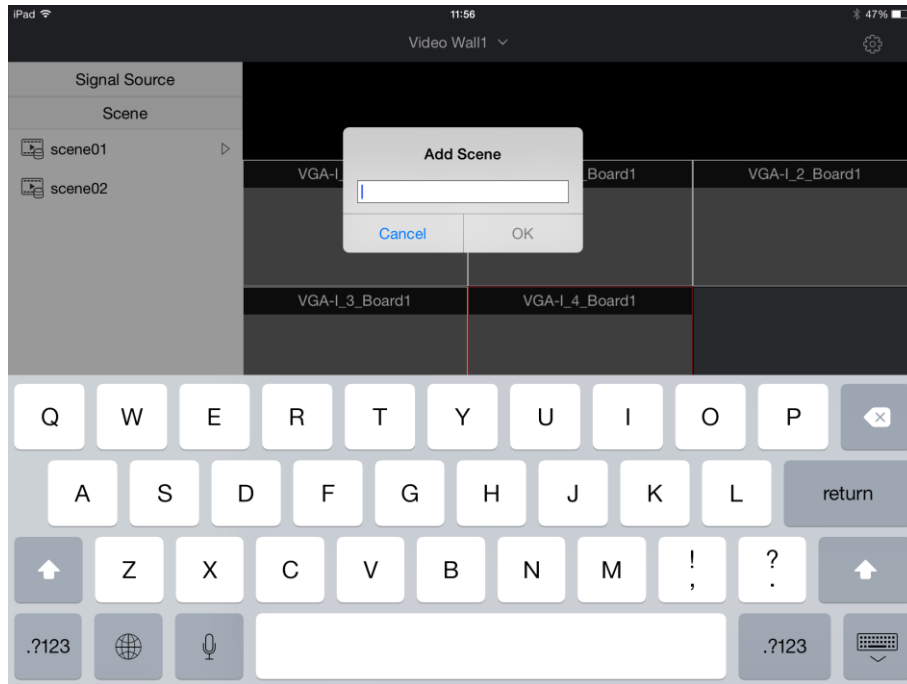



Figure 7-6 Add a Scene

7.6.2 Save the Video Wall Layout to the Scene

Step 1 Tap  and select the desired scene.

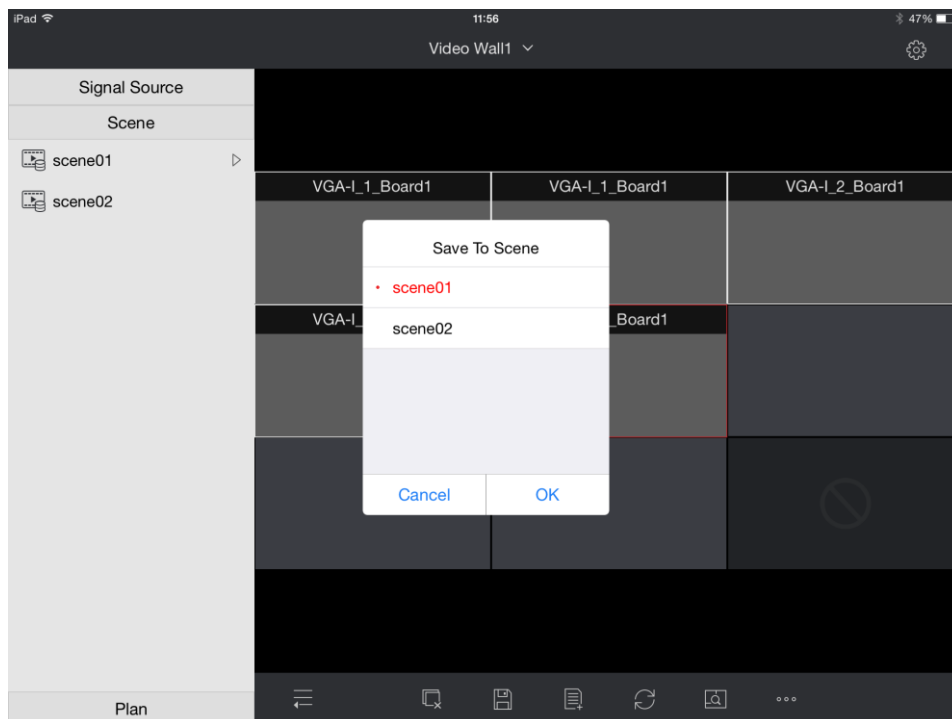

Figure 7-7 Save Layout

Step 2 Tap **OK**.

7.6.3 Call a Scene

Step 1 Tap **Scene** on the left list.

Step 2 Select the scene you want to call and tap **Call**. You can also tap **Rename** or **Delete** to execute corresponding operations.

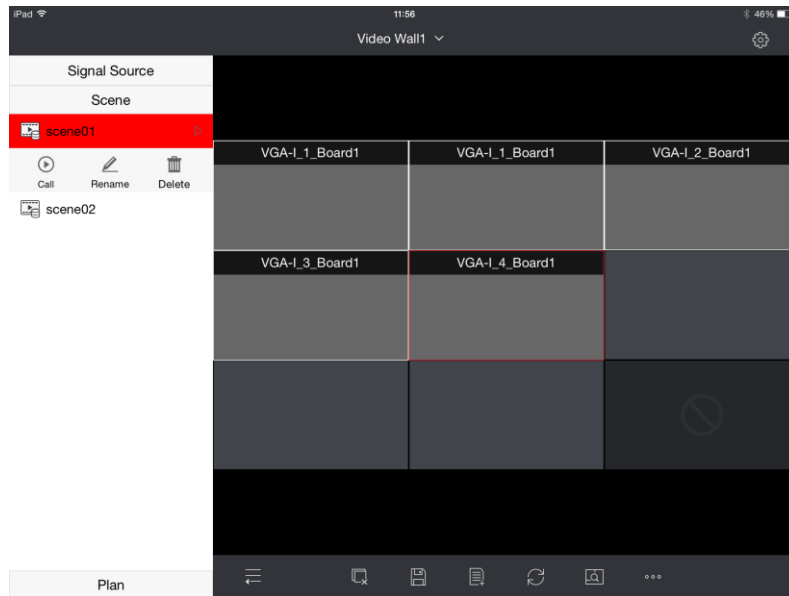



Figure 7-8 Call a Scene

7.7 Call a Plan

Step 1 Tap **Plan** on the left list.

Step 2 Select the plan you want to call and tap .

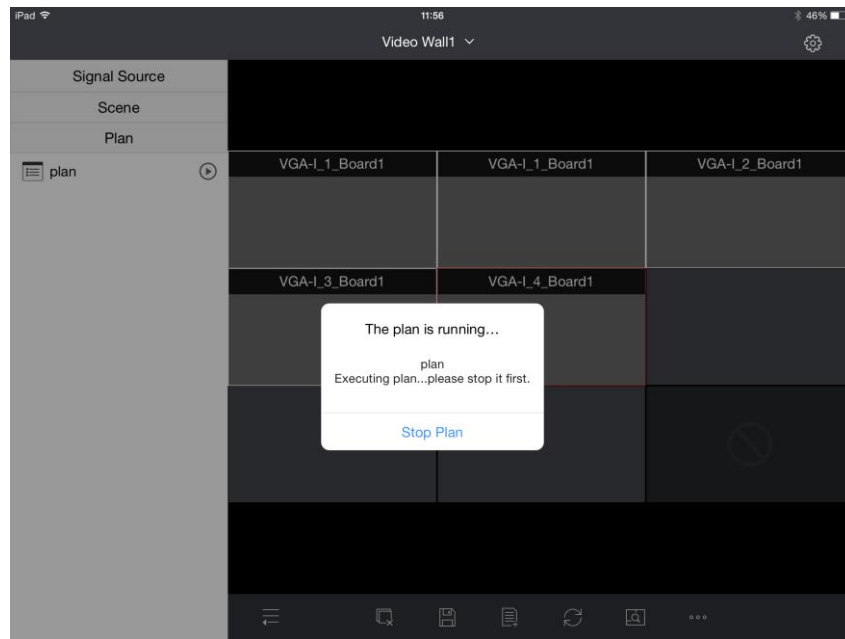

Figure 7-9 Call a Plan

7.8 Other Operation

7.8.1 Mirroring Between Video Wall Areas

If you enable the feature, the video wall will be automatically divided into one or more areas. And you can copy the image of one area to other areas. Here are the video wall division principles:

- Adjacent outputs of the same type will be divided into one area. That is LCD and LED output will not be divided into the same area. Each output belongs to a certain area.
- The profile of an area is a rectangle. An area contains at least one output.
- Areas can overlap with each other. But mirror operation is not supported among these areas.
- You can copy images between LCD and LED areas.
- The window that stretches over both the target area and the original area will be closed.
- When the three sides of an LED/LCD area are surrounded by an LCD/LED area, you cannot copy images between the two areas.

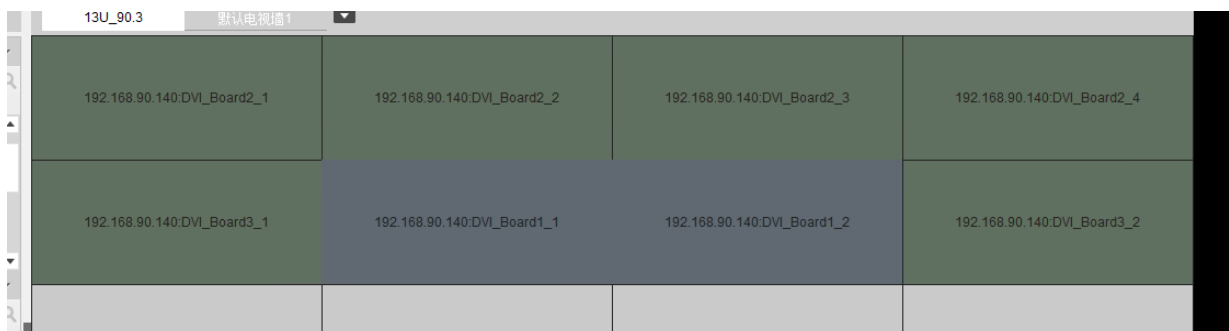



Figure 7-10 Three Sides of the LCD Area are Surrounded by the LED Area

Step 1 Tap  on the lower-right corner.

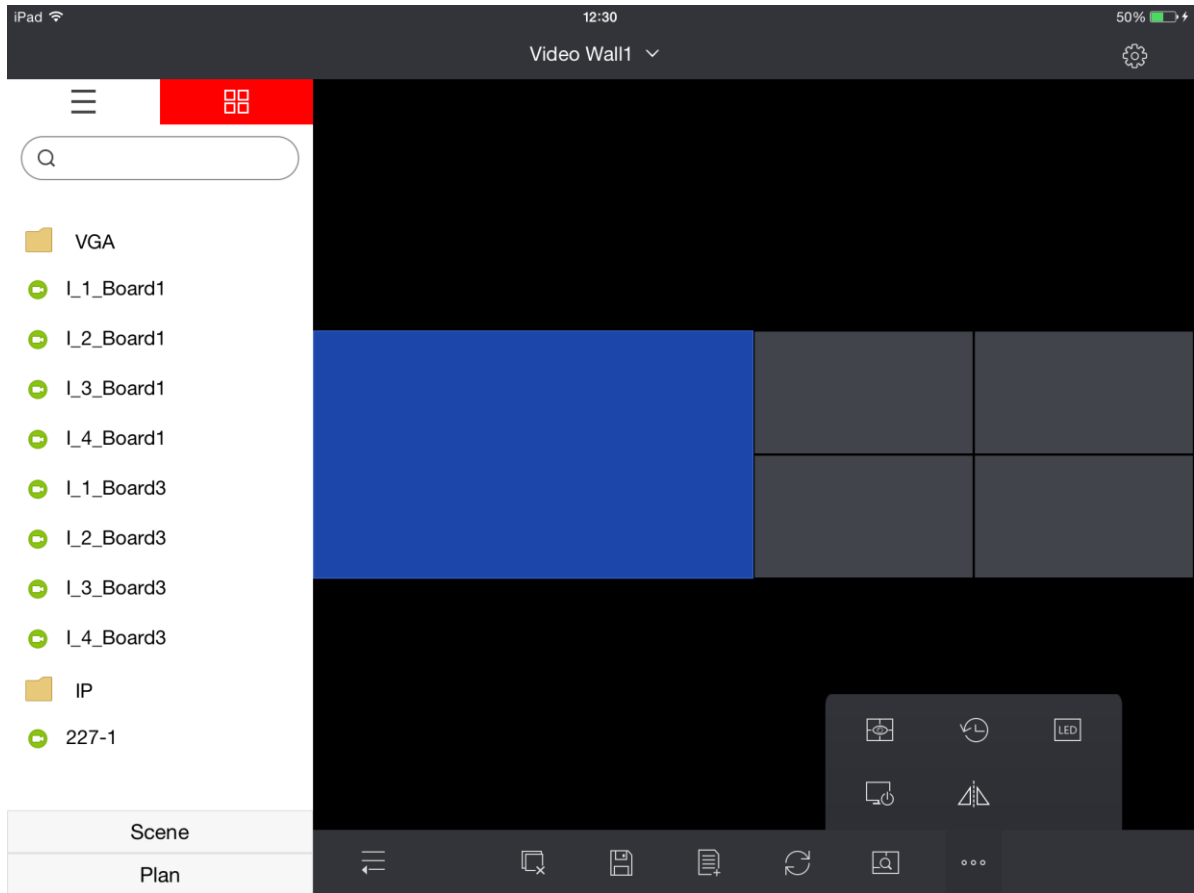

Figure 7-11 Video Wall Layout

Step 2 Tap , and the video wall is divided into several areas. You can copy the image of one area to another area.



Figure 7-12 Mirror Video Wall

Step 3 Drag one area to another area, and tap **OK**.

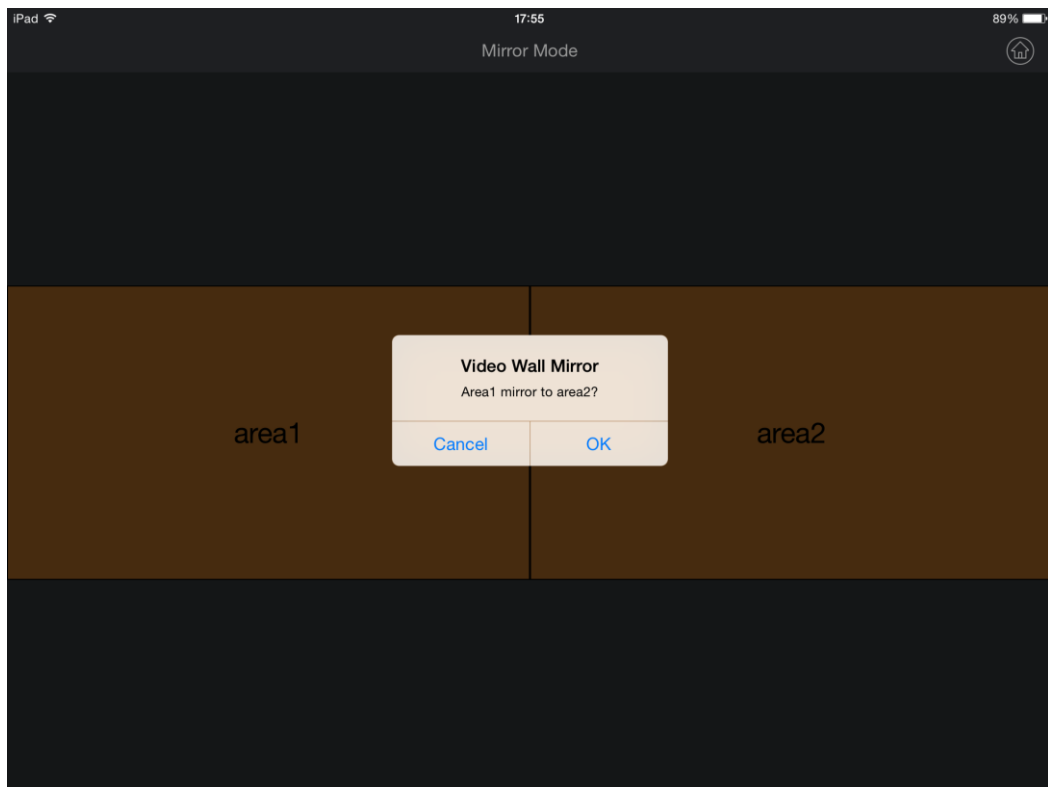



Figure 7-13 Copy Images from One Area to Another

7.8.2 Refresh

iVMS-4510 HD can automatically refresh to obtain the latest video wall configuration. Follow the steps to set the refreshing interval.

Step 1 Tap  on the lower-right corner.

Step 2 Tap .

Step 3 Select the desired interval and tap **OK**.

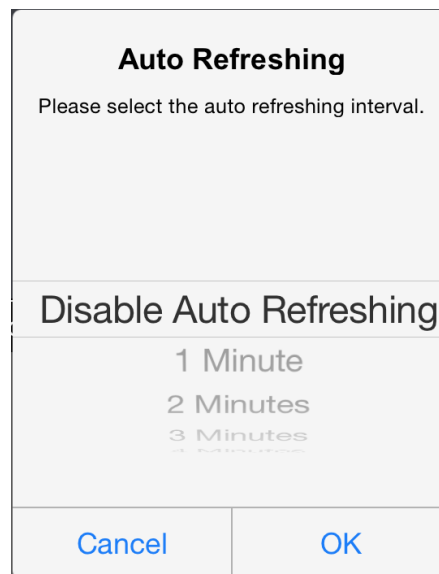



Figure 7-14 Automatic Refreshing Interval

7.8.3 Virtual LED Screen

Configure the virtual screen for LED output.

Step 1 Tap  on the lower-right corner.

Step 2 Tap .

Step 3 Select an LED output and set the virtual screen. The background of LED outputs is blue.

Step 4 Select **Row** and **Column**. The virtual screen is valid only when **Row** and **Column** are set.

Step 5 Tap **OK**.

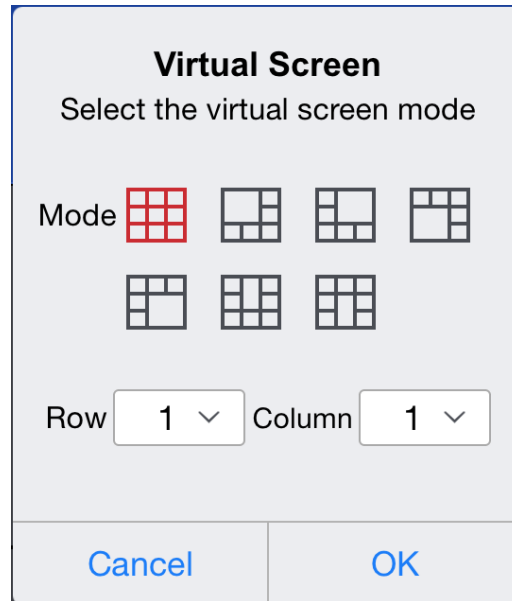



Figure 7-15 Set Virtual Screen

7.8.4 Preview

If you have set the preview in video wall client software, you can preview the images before displaying them in the video wall in iVMS-4510 HD.

Step 1 Tap  on the lower-right corner.

Step 2 Tap . The preview image will be shown as below.

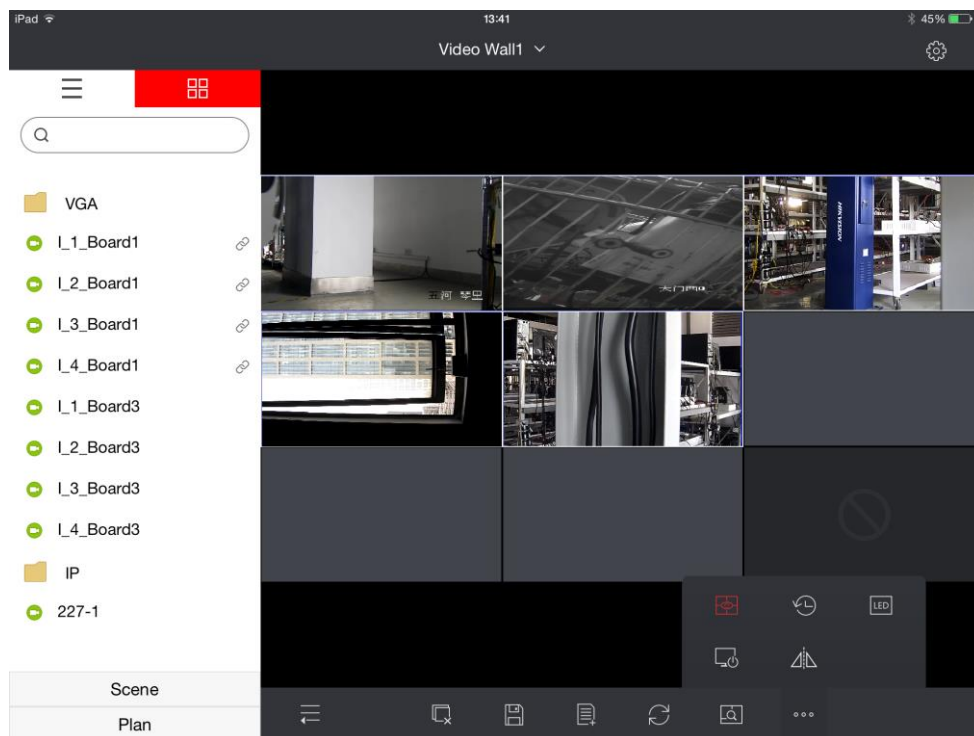



Figure 7-16 Preview

7.8.5 Logout

Tap  in the upper-right corner, tap **Logout**, and confirm the operation.

7.8.6 About

Tap  in upper-right corner and tap **About** to view the open source license and end user license agreement.

