

DS-D4419FI-CBF LED Display



- Cabinet is die-casting aluminum integrated.
- Modularized design: LED cabinet consists of frame, power box and modules. For different pixel pitches, they can share same power box and frame.
- Seamless connection: There are four locks totally on each cabinet. They can lock cabinets well for seamless splicing.
- One end of the power cables between two cabinets is fixed. Such design can help to realize fast installation and disassembly.
- Labor saving: One single person can manage installation easily, which can save labor cost.
- Screen can be both inward and outward curve. (optional)
- 90° connection is available. (needs customization)
- Anti-collision design: There are protectors at the four corners of the cabinets, which can help to protect lamps effectively during transportation. (needs customization)
- Multi-application scenarios: It is widely used in concerts, events, opera houses, theaters, hotels, auditorium, multi-function hall, lecture hall, high-end entertainment venues, and so forth.

▪ Specification

	Model	DS-D4419FI-CBF
Cabinet	Pixel Configuration	SMD 3-in-1
	Pixel Pitch Category	P1.95
	Pixel Pitch	1.95 mm
	Modules Component	2 × 2
	Dimensions (W × H × D)	500 (H) × 500 (W) × 53 (D) mm (19.685"×19.685"×2.087") (not including modules) 500 (H) × 500 (W) × 70.6 (D) mm (19.685"×19.685"×2.78") (including modules)
	Resolution	256×256
	Area	0.25 m ²
	Weight	6.8 Kg (14.99 lb)
	Pixel Density	262144 dots/m ²
	Lamp Board Housing	No housing
	Cabinet Material	Die-casting aluminum
	Maintenance Method	Front and rear maintenance
	Cabinet Flatness	0.1 mm
	Protection Level	Front protection level IP40
Display	White Balance Brightness	≥ 800 cd/m ²
	Color Temperature	6500 K to 10000 K adjustable
	Viewing Angle	Horizontal 160°, vertical 140°
	Contrast Ratio	≥ 3000:1
	Color Uniformity	≤ ± 0.003Cx, Cy
	Brightness Uniformity	≥ 97%
Processing Performance	Driving Method	Constant current driving
	Frame Frequency	60 Hz
	Refresh Rate	Up to 3840 Hz
	Grey Level	Up to 16 bit
	Display Color	281 trillion
Power	Power Supply	110 V/220 V
	Max. Consumption	≤ 600 W/m ²
	Average Consumption	≤ 200 W/m ²
Working Environment	Working Temperature	-10~40 °C
	Working Humidity	10%~80% RH
	Storage Humidity	10%~85% RH
	Storage Temperature	-20~60 °C
General	Gross Weight	75 Kg (165.35 lb) ± 10%
	Package Dimensions (W × H × D)	930 (L) × 690 (W) × 540 (H) mm (36.61" × 27.17" × 21.26") (8-in-1 wooden box)
	Lifespan	Lamp 100,000 hours

▪ **Available Model**

DS-D4419FI-CBF

▪ **Dimension**

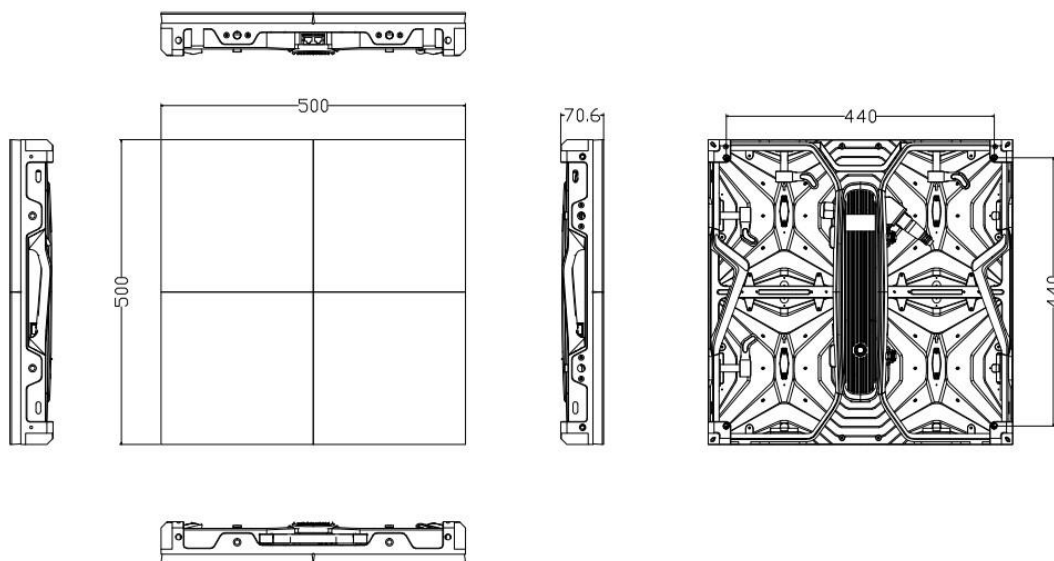

Headquarters

No.555 Qianmo Road, Binjiang District,
Hangzhou 310051, China
T +86-571-8807-5998
www.hikvision.com



Follow us on social media to get the latest product and solution information.

