

DS-2DY3220IW-DE/DE4 (B) 2MP Network IR PTZ Camera



Hikvision DS-2DY3220IW-DE/DE4 2MP Network IR PTZ Cameras adopt 1/2.8" progressive scan CMOS chip. With the 20× optical zoom lens, the camera offers more details over expansive areas.

This series of cameras can be widely used for wide ranges of high-definition, such as the rivers, forests, roads, railways, airports, ports, squares, parks, scenic spots, stations and large venues, etc.

Key Features

- 1/2.8" Progressive Scan CMOS
- Up to 1920 × 1080 resolution
- 20× Optical Zoom, 16× Digital Zoom
- Digital WDR, 3D DNR, HLC, Smart IR
- Up to 100 m IR distance
- 12 VDC & PoE (802.3at, class4)
- Support H.265 video compression



Specification

Camera Module	DS-2DY3220IW-DE/DE4 2MP Network IR PTZ Camera
Image Sensor	1/2.8" progressive scan CMOS
Min. Illumination	Color: 0.05 Lux @(F1.6, AGC ON) B/W: 0.01 Lux @(F1.6, AGC ON) 0 Lux with IR
White Balance	Auto/Manual/ATW (Auto Tracking White Balance)/Indoor/Outdoor/Fluorescent Lamp/Sodium Lamp
AGC	Auto/Manual
Shutter Time	1/1 s to 1/30,000 s
Day & Night	IR Cut Filter
Digital Zoom	16×
Privacy Mask	8 programmable privacy masks
Focus Mode	Auto/Semi-automatic/Manual
3D DNR	Yes
BLC	Yes
Digital WDR	Yes
Regional Exposure	Yes
Regional Focus	Yes
Lens	
Focal Length	4.7 mm to 94 mm, 20× Optical
Zoom Speed	Approx. 2.7 s (Optical Lens, Wide-Tele)
Field of View	61.4° to 2.9° (Wide-Tele)
Working Distance	10 mm to 1500mm (Wide-Tele)
Aperture Range	F1.6 to F3.5
IR	
IR Distance	Up to 100 m
IR Intensity	Automatically adjusted, depending on the zoom ratio
PTZ	
Movement Range (Pan)	360° endless
Pan Speed	Configurable, from 0.5°/s to 50°/s. Preset speed 50°/s
Movement Range (Tilt)	From -40° to 30°
Tilt Speed	Configurable, from 0.5°/s to 25°/s. Preset speed 25°/s
Proportional Zoom	Yes
Presets	300
Patrol Scan	8 patrols, up to 32 presets for each patrol
Pattern Scan	4 pattern scans, record time over 10 minutes for each scan
Power-off Memory:	Yes
Park Action	Preset/Pattern Scan/Patrol Scan/Auto Scan/Tilt Scan/Random Scan/Frame Scan/Panorama Scan
PTZ Position Display	ON/OFF
Preset Freezing	Yes
Scheduled Task	Preset/Pattern Scan/Patrol Scan/Auto Scan/Tilt Scan/Random Scan/Frame Scan/Panorama Scan/Dome Reboot/Dome Adjust
Features	
Smart Detection	Intrusion Detection, Line Crossing Detection, Region Exiting Detection, Region Entrance Detection
ROI encoding	Main stream, sub-stream and third stream respectively support two fixed areas.

Network	
Max. Resolution	1920 × 1080
Main Stream	50Hz: 25fps (1920 × 1080, 1280 × 960, 1280 × 720) 50fps (1920 × 1080, 1280 × 960, 1280 × 720) 60Hz: 30fps (1920 × 1080, 1280 × 960, 1280 × 720) 60fps (1920 × 1080, 1280 × 960, 1280 × 720)
Sub-Stream	50Hz: 25fps (704 × 576, 640 × 480, 352 × 288) 60Hz: 30fps (704 × 480, 640 × 480, 352 × 240)
Third Stream	50Hz: 25fps (1920 × 1080, 1280 × 960, 1280 × 720, 704 × 576, 640 × 480, 352 × 288) 60Hz: 30fps (1920 × 1080, 1280 × 960, 1280 × 720, 704 × 480, 640 × 480, 352 × 240)
Video Compression	Main Stream: H.265+/H.265/H.264+/H.264 Sub-Stream: H.265/H.264/MJPEG Third Stream: H.265/H.264/MJPEG H.264 with Baseline/Main/High Profile
Audio compression	G.711alaw/G.711ulaw/G.722.1/G.726/MP2L2/PCM
Protocols	IPv4/IPv6, HTTP, HTTPS, 802.1x, Qos, FTP, SMTP, UPnP, SNMP, DNS, DDNS, NTP, RTSP, RTCP, RTP, TCP/IP, DHCP, PPPoE, Bonjour
API	ONVIF (Profile S, Profile G, Profile T), ISAPI, SDK
Simultaneous Live View	Up to 20 channels
User/Host	Up to 32 users 3 levels: Administrator, Operator and User
Security Measures	User authentication (ID and PW), Host authentication (MAC address); HTTPS encryption; IEEE 802.1x port-based network access control; IP address filtering
System Integration	
Alarm Input	1-ch alarm input
Alarm Output	1-ch alarm output
Alarm Linkage	Alarm actions, such as Preset, Patrol Scan, Pattern Scan, Memory Card Video Record, Trigger Recording, Notify Surveillance Center, Upload to FTP/Memory Card/NAS, Send Email, etc.
Audio Input	1-ch audio input
Audio Output	1-ch audio output
Network Interface	1 RJ45 10 M/100 M Ethernet Interface; PoE (802.3at, class4)
Storage	Built-in memory card slot, support Micro SD/SDHC/SDXC, up to 128 GB; NAS (NFS, SMB/ CIFS), ANR
Client	iVMS-4200, iVMS-4500, iVMS-5200
Web Browser	IE 8 to 11, Chrome 31.0+, Firefox 30.0+, Edge 16.16299+
General	
Language (Web Browser Access)	32 languages. English, Russian, Estonian, Bulgarian, Hungarian, Greek, German, Italian, Czech, Slovak, French, Polish, Dutch, Portuguese, Spanish, Romanian, Danish, Swedish, Norwegian, Finnish, Croatian, Slovenian, Serbian, Turkish, Korean, Traditional Chinese, Thai, Vietnamese, Japanese, Latvian, Lithuanian, Portuguese (Brazil)
Power	12 VDC, 1.6 A and PoE (802.3at), 42.5 to 57 VDC, 0.6 A, Class4 Max. 19 W, including max. 9.2W for IR
Working Environment	Working Temperature: Outdoor: -30°C to 65°C (-22°F to 149°F) Working Humidity: ≤ 95%
Protection Level	IP66 Standard; 6000V Lightning Protection, Surge Protection and Voltage Transient Protection
Dimensions(mm)	-DE: 367 mm × 122 mm × 242 mm (14.45" × 4.80" × 9.53") -DE4: 255 mm × 129 mm × 195 mm (10.03" × 5.08" × 7.68")
Weight	Approx. 3 kg (6.61 lb)

DORI

The DORI (detect, observe, recognize, identify) distance gives the general idea of the camera ability to distinguish persons or objects within its field of view.

It is calculated based on the camera sensor specification and the criteria given by EN 62676-4: 2015.

DORI	Detect	Observe	Recognize	Identify
Definition	25 px/m	63 px/m	125 px/m	250 px/m
Distance (Tele)	1061.8 m (3483.7 ft)	421.4 m (1382.4 ft)	212.4 m (696.7 ft)	106.2 m (348.4 ft)

Order Model

DS-2DY3220IW-DE (B)

DS-2DY3220IW-DE4 (B)

Dimensions

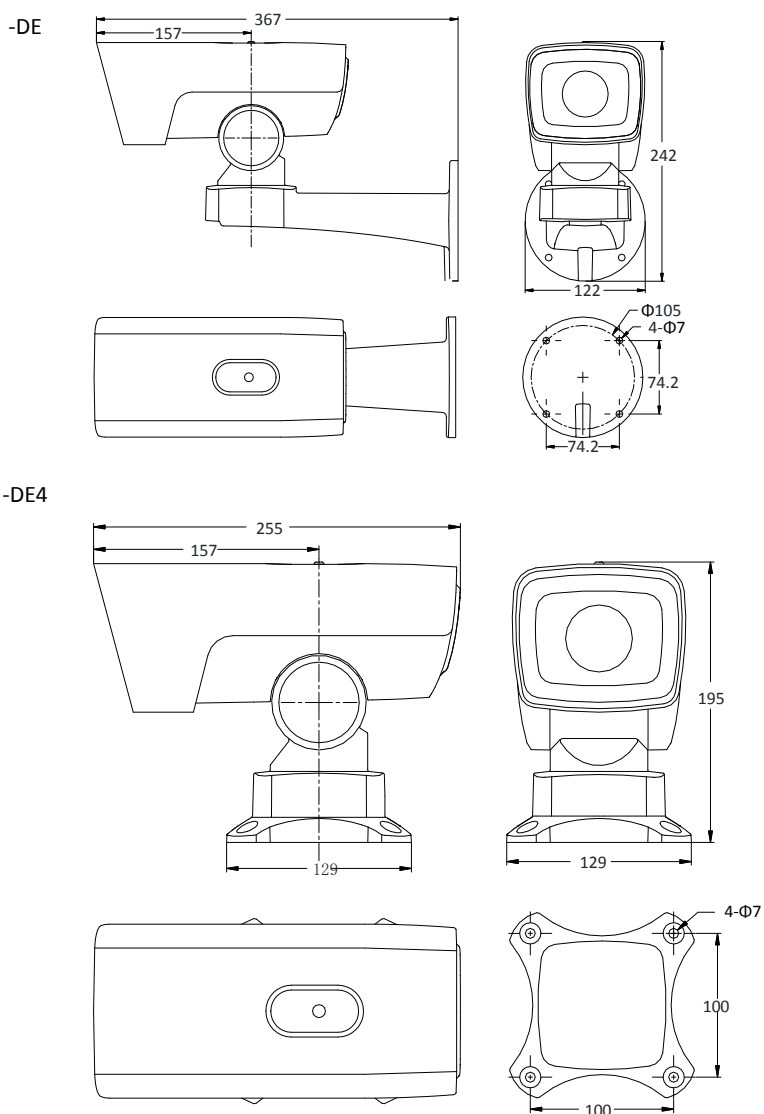

Unit: mm

Accessory

Included:



ASW0081-1220002W

Power adapter

Optional:



DS-1280ZJ-M (SPTZ)
Junction Box



DS-1281ZJ-M (SPTZ)
Inclined Base Mounting
Bracket



DS-1275ZJ (SPTZ)
Vertical Pole Mounting Bracket



LAS60-57CN-RJ45
Hi-PoE midspan

Distributed by



HIKVISION®

Headquarters

No.555 Qianmo Road, Binjiang District,
Hangzhou 310051, China
T +86-571-8807-5998
overseasbusiness@hikvision.com

Hikvision USA
T +1-909-895-0400
sales.usa@hikvision.com

Hikvision Australia
T +61-2-8599-4233
salesau@hikvision.com

Hikvision India
T +91-22-28469900
sales@pramahikvision.com

Hikvision Canada
T +1-866-200-6690
sales.canada@hikvision.com

Hikvision Thailand
T +662-275-9949
sales.thailand@hikvision.com

Hikvision Europe
T +31-23-5542770
sales.eu@hikvision.com

Hikvision Italy
T +39-0438-6902
info.it@hikvision.com

Hikvision Brazil
T +55 11 3318-0050
Latam.support@hikvision.com

Hikvision Turkey
T +90 (216)521 7070- 7074
sales.tr@hikvision.com

Hikvision Malaysia
T +601-7652-2413
sales.my@hikvision.com

Hikvision UK & Ireland
T +01628-902140
sales.uk@hikvision.com

Hikvision South Africa
Tel: +27 (10) 0351172
sale.africa@hikvision.com

Hikvision France
T +33(0)1-85-330-450
info.fr@hikvision.com

Hikvision Kazakhstan
T +7-727-9730667
nikia.panfilov@hikvision.ru

Hikvision Vietnam
T +84-974270888
sales.vt@hikvision.com

Hikvision UAE
T +971-4-4432090
salesme@hikvision.com

Hikvision Singapore
T +65-6684-4718
sg@hikvision.com

Hikvision Spain
T +34-91-737-16-55
info.es@hikvision.com

Hikvision Tashkent
T +99-87-1238-9438
uzb@hikvision.ru

Hikvision Hong Kong
T +852-2151-1761
info.hk@hikvision.com

Hikvision Russia
T +7-495-669-67-99
saleru@hikvision.com

Hikvision Korea
T +82-(0)31-731-8817
sales.korea@hikvision.com

Hikvision Poland
T +48-22-460-01-50
info.pl@hikvision.com

Hikvision Indonesia
T +62-21-2933759
Sales.Indonesia@hikvision.com

Hikvision Colombia
sales.colombia@hikvision.com