

iDS-2CD7026G0/P-AP 2 MP ANPR Box Network Camera

DarkFighter

DeepinView^{series}



Hikvision has been dedicated to develop products with security since established. Hikvision always follows security by design principle and has adopted many methods of security technologies into our product development lifecycle, including terminal security, data security, application security, network security, and privacy protection. In the meantime, the security technologies used by Hikvision are all in compliance with local applicable laws and safety regulations. These security measures could enhance product's cyber security protection capability and protect your devices as well as your data from malicious cyber attacks.

- High quality imaging with 2 MP resolution
- Excellent low-light performance via DarkFighter technology
- Clear imaging against strong back light due to 140 dB WDR technology
- License Plate Recognition
- Efficient H.265+ compression technology to save bandwidth and storage
- 5 streams to meet a wide variety of applications
- Built-in microphone for real-time audio security

▪ Function

Perimeter Protection

With embedded deep learning based target detection and classification algorithms, the camera carries out the duty of perimeter protection, monitoring the actions of line crossing, intrusion, region entrance, and region exiting. The algorithms greatly filter out the mistaken alarm caused by the interference of leaves, lights, animal, flag, etc.

Road Traffic and Vehicle Detection

With embedded deep learning based license plate capture and recognition algorithms, the camera alone can achieve plate capture and recognition. The algorithm enjoys the high recognition accuracy of common plates and complex-structured plates, which is a great step forward comparing to traditional algorithms. Blocklist and allowlist are available for plate categorization and separate alarm triggering.

Parking Management

With embedded deep learning algorithms, the camera can achieve parking space status detection and vacant parking space alarm for parking management. Both distant view mode and close view mode are supported. For the close view mode, the camera can also achieve license plate recognition. Blocklist and allowlist are available for plate categorization and separate alarm triggering.

▪ Specification

Camera	
Image Sensor	1/1.8" Progressive Scan CMOS
Max. Resolution	1920 × 1080
Min. Illumination	Color: 0.0005 Lux @ (F1.2, AGC ON) B/W: 0.0001 Lux @ (F1.2, AGC ON)
Shutter Time	1 s to 1/100,000 s
Day & Night	IR cut filter Blue glass module to reduce ghost phenomenon
Lens	
Lens Mount	CS mount
Video	
Main Stream	50 Hz: 50 fps (1920 × 1080, 1280 × 960, 1280 × 720) 60 Hz: 60 fps (1920 × 1080, 1280 × 960, 1280 × 720)
Sub-Stream	50 Hz: 25 fps (704 × 576, 640 × 480) 60 Hz: 30 fps (704 × 480, 640 × 480)
Third Stream	50 Hz: 25 fps (1920 × 1080, 1280 × 720, 704 × 576, 640 × 480) 60 Hz: 30 fps (1920 × 1080, 1280 × 720, 704 × 480, 640 × 480)
Fourth Stream	50 Hz: 25 fps (704 × 576, 640 × 480) 60 Hz: 30 fps (704 × 480, 640 × 480)
Fifth Stream	50 Hz: 25 fps (704 × 576, 640 × 480) 60 Hz: 30 fps (704 × 480, 640 × 480)
Video Compression	Main stream: H.265+/H.265/H.264+/H.264, Sub-stream: H.265/H.264/MJPEG, Third stream: H.265/H.264, Fourth stream: H.265/H.264/MJPEG, Fifth stream: H.265/H.264/MJPEG
Video Bit Rate	32 Kbps to 8 Mbps
H.264 Type	Baseline Profile, Main Profile, High Profile
H.265 Type	Main Profile
Bit Rate Control	CBR, VBR
Scalable Video Coding (SVC)	H.264 and H.265 encoding
Region of Interest (ROI)	4 fixed regions for each stream
Target Cropping	Yes
e-PTZ	Support Patrol and Auto Tracking settings
Audio	
Audio Type	Mono sound
Audio Compression	G.711/G.722.1/G.726/MP2L2/PCM/MP3/AAC-LC
Audio Bit Rate	64 Kbps (G.711ulaw/G.711alaw)/16 Kbps (G.722.1)/16 Kbps (G.726)/32 to 192 Kbps (MP2L2)/8 to 320 Kbps (MP3)/16 to 64 Kbps (AAC-LC)
Audio Sampling Rate	8 kHz/16 kHz/32 kHz/44.1 kHz/48 kHz
Environment Noise Filtering	Yes
Network	
Protocols	TCP/IP, ICMP, HTTP, HTTPS, FTP, SFTP, SRTP, DHCP, DNS, DDNS, RTP, RTSP, RTCP, PPPoE, NTP, UPnP, SMTP, SNMP, IGMP, 802.1X, QoS, IPv4, IPv6, UDP, Bonjour, SSL/TLS, WebSocket, WebSockets

Simultaneous Live View	Up to 20 channels
API	Open Network Video Interface (Profile S, Profile G, Profile T, Profile M),ISAPI,SDK,ISUP
User/Host	Up to 32 users 3 user levels: administrator, operator, and user
Security	Password protection, complicated password, HTTPS encryption, 802.1X authentication (EAP-TLS, EAP-LEAP, EAP-MD5), watermark, IP address filter, basic and digest authentication for HTTP/HTTPS, WSSE and digest authentication for Open Network Video Interface, RTP/RTSP OVER HTTPS, Control Timeout Settings, Security Audit Log, TLS 1.2, TLS 1.3, TPM 2.0 (FIPS 140-2 level 2), AES128/256
Network Storage	NAS (NFS, SMB/CIFS),Auto Network Replenishment (ANR), Together with high-end Hikvision memory card, memory card encryption and health detection are supported.
Client	iVMS-4200,Hik-Connect,Hik-Central
Web Browser	Plug-in required live view: IE 10, IE 11, Plug-in free live view: Chrome 57.0+, Firefox 52.0+, Edge 89+, Safari 11+, Local service: Chrome 57.0+, Firefox 52.0+, Edge 89+
Image	
Image Parameters Switch	Yes
Image Settings	Rotate mode,saturation,brightness,contrast,sharpness,gain,white balance,adjustable by client software or web browser
Day/Night Switch	Day,Night,Auto,Schedule,Alarm Trigger,Video Trigger
Wide Dynamic Range (WDR)	140 dB
SNR	≥ 52 dB
Image Enhancement	BLC,HLC,3D DNR,Distortion Correction,Defog
Picture Overlay	LOGO picture can be overlaid on video with 128 × 128 24 bit bmp format.
Image Stabilization	EIS
Privacy Mask	8 programmable polygon privacy masks
Interface	
Video Output	1 Vp-p Composite Output (75 Ω/CVBS) (Only for debugging)
Ethernet Interface	1 RJ45 100 M/1000 M self-adaptive Ethernet port
On-Board Storage	Built-in memory card slot, support microSD/microSDHC/microSDXC card, up to 1 TB
Built-in Microphone	Yes,1 built-in microphone
Audio	1 input (line in), 1 output (line out), 3.5 mm connector
Alarm	2 inputs, 2 outputs (max. 24 VDC, 1 A)
RS-485	1 RS-485 (half duplex, HIKVISION, Pelco-P, Pelco-D, self-adaptive)
Reset Key	Yes
Power Output	12 VDC, max. 100 mA
Event	
Basic Event	Motion detection (support alarm triggering by specified target types (human and vehicle)),video tampering alarm,exception (network disconnected, IP address conflict, illegal login, abnormal restart, HDD full, HDD error),video quality diagnosis
Smart Event	scene change detection,audio exception detection,defocus detection
Linkage	Upload to FTP/NAS/memory card,notify surveillance center,send email,trigger alarm output,trigger recording,trigger capture,audible warning

Deep Learning Function	
Perimeter Protection	Line crossing, intrusion, region entrance, region exiting Support alarm triggering by specified target types (human and vehicle) Support combined event alarm triggering
Metadata	Intrusion detection, line crossing detection, region entrance detection, region exiting detection, road traffic
Parking Management	Support distant view mode and close view mode Distant view mode: support status detection on up to 40 parking spaces, parking duration detection, and vacant parking space alarm Close view mode: support status detection on up to 4 parking spaces, license plate recognition, parking timeout alarm, and vacant parking space alarm
Road Traffic and Vehicle Detection	Smart Function: Support license plate recognition of vehicles and motorcycles (only in checkpoint scenario) Support vehicle attribute detection, including vehicle type, color, brand, driving direction, etc. Support vehicle and non-vehicle counting Blocklist and allowlist: up to 10,000 records LPR Countries/Regions: 4 areas (Europe, Middle East, Asia-Pacific, Africa) and more than 124 countries/regions Accuracy (Under recommended installation and lighting conditions): License plate recognition rate $\geq 98\%$ Capture rate $\geq 99\%$ Driving direction accuracy rate $\geq 98\%$ Vehicle Capture Speed: Front installation in checkpoint scenario: up to 120 km/h Side installation: up to 80 km/h Capture Mode: License Plate and Vehicle Mode, Vehicle Priority Mode
General	
Power	12 VDC $\pm 20\%$, 0.9 A, max. 10.8 W, two-core terminal block 24 VAC $\pm 20\%$, 0.44 A, max. 10.4 W, two-core terminal block PoE: IEEE 802.3af, Type 1, Class 3, 36 V to 57 V, 0.33 A to 0.21 A, max. 11.6 W
Material	Aluminum alloy body
Dimension	142.5 mm \times 69.8 mm \times 68 mm (5.61" \times 2.75" \times 2.68")
Package Dimension	315 mm \times 140 mm \times 140 mm (12.4" \times 5.51" \times 5.51")
Weight	Approx. 730 g (1.96 lb.)
With Package Weight	Approx. 1115 g (2.99 lb.)
Startup and Operating Conditions	-30 $^{\circ}$ C to 60 $^{\circ}$ C (-22 $^{\circ}$ F to 140 $^{\circ}$ F). Humidity 95% or less (non-condensing)
Storage Conditions	-30 $^{\circ}$ C to 60 $^{\circ}$ C (-22 $^{\circ}$ F to 140 $^{\circ}$ F). Humidity 95% or less (non-condensing)
Language	33 languages: English, Russian, Estonian, Bulgarian, Hungarian, Greek, German, Italian, Czech, Slovak, French, Polish, Dutch, Portuguese, Spanish, Romanian, Danish, Swedish, Norwegian, Finnish, Croatian, Slovenian, Serbian, Turkish, Korean, Traditional Chinese, Thai, Vietnamese, Japanese, Latvian, Lithuanian, Portuguese (Brazil), Ukrainian
General Function	Anti-banding, heartbeat, mirror, flash log, password reset via email, pixel counter
Device Management	Supports adding alarm box (DS-FM2466) in the LAN to expand 6 additional input and 6 output alarm interfaces

Approval	
EMC	FCC: 47 CFR Part 15, Subpart B, CE-EMC: EN 55032: 2015, EN 61000-3-2:2019, EN 61000-3-3: 2013+A1:2019, EN 50130-4: 2011 +A1: 2014, RCM: AS/NZS CISPR 32: 2015, IC: ICES-003: Issue 7, KC: KN32: 2015, KN35: 2015
Safety	UL: UL 62368-1, CB: IEC 62368-1: 2014+A11, CE-LVD: EN 62368-1: 2014/A11: 2017, BIS: IS 13252 (Part 1): 2010/IEC 60950-1: 2005, LOA: IEC/EN 60950-1
Environment	CE-RoHS: 2011/65/EU, WEEE: 2012/19/EU, Reach: Regulation (EC) No 1907/2006

▪ Typical Application

Hikvision products are classified into three levels according to their anti-corrosion performance. Refer to the following description to choose for your using environment.

This model has NO SPECIFIC PROTECTION.

Level	Description
Top-level protection	Hikvision products at this level are equipped for use in areas where professional anti-corrosion protection is a must. Typical application scenarios include coastlines, docks, chemical plants, and more.
Moderate protection	Hikvision products at this level are equipped for use in areas with moderate anti-corrosion demands. Typical application scenarios include coastal areas about 2 kilometers (1.24 miles) away from coastlines, as well as areas affected by acid rain.
No specific protection	Hikvision products at this level are equipped for use in areas where no specific anti-corrosion protection is needed.

▪ Physical Interface

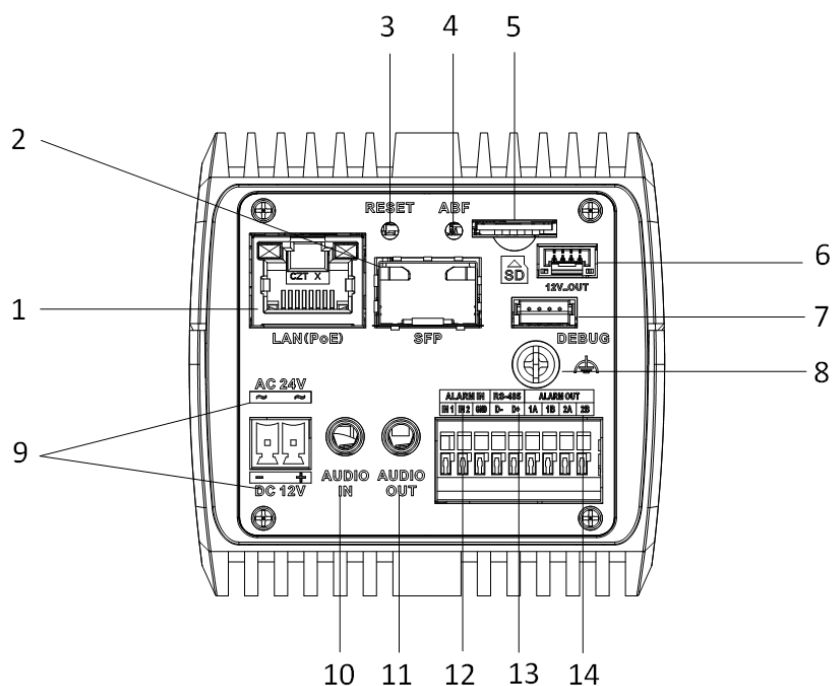

No.	Description	No.	Description
1	LAN (PoE)	8	GROUND
2	SFP	9	AC 24 V/DC 12 V
3	RESET Button	10	AUDIO IN
4	ABF	11	AUDIO OUT
5	MicroSD Card Slot	12	ALARM IN
6	DC 12 V OUT	13	RS-485
7	DEBUG	14	ALARM OUT

*Note: The interface varies depending on the model. Please refer to the actual product.

Installation Recommendation

Entrance/Exit

Horizontal Angle

The view angle of the camera should be within 30° to the path of movement.

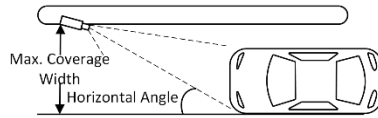

Vertical Angle

The angle between the lens direction and the horizontal should be less than 30°.

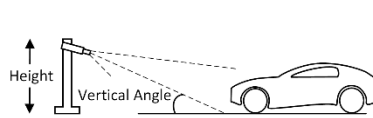

City Street

Side of the Lane

Horizontal Angle

The horizontal angle should not exceed 30°.

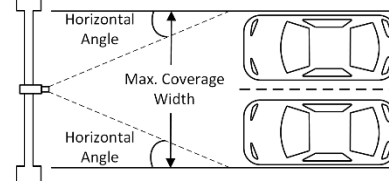

Recommended:
Lane Width: < 3.5 m
Camera Installation Height: 1.6 to 2 m

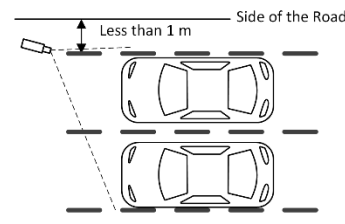

Middle of the Road

Side of the Gantry

Vertical Angle

The angle between the lens direction and the horizontal should be less than 30°.

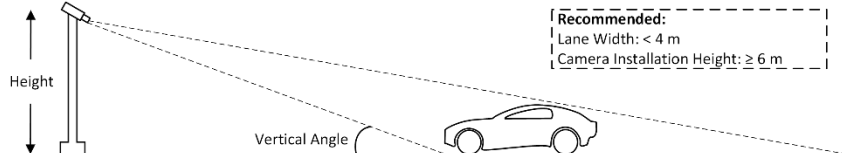

Recommended:
Lane Width: < 4 m
Camera Installation Height: ≥ 6 m

Camera Position	Lens	Height (m)	Suggested Vertical Angle	Suggested Trigger Distance (m)	Max. Coverage Width	Max. Horizontal Angle	Vertical Angle Range	Capture Range (m)
Side of the Lane	2.8 to 12 mm	1.5	20°	4	4.5	30°	15° to 30°	2.5 to 5.5
Side of the Lane	2.8 to 12 mm	2	20°	5.5	4.5	30°	15° to 30°	3.5 to 7.5
Side of the Lane	2.8 to 12 mm	2.5	20°	6.5	4.5	30°	15° to 30°	4.5 to 9
Side of the Lane	8 to 32 mm	3	20°	8	6	30°	15° to 30°	5 to 11
Side of the Lane	8 to 32 mm	4	20°	11	6	30°	15° to 30°	6 to 14
Side of the Lane	8 to 32 mm	5	20°	13.5	6	30°	15° to 30°	8.5 to 18
Side of the Lane	8 to 32 mm	6	20°	16.5	6	30°	15° to 30°	10 to 22
Middle of the Road	8 to 32 mm	3	20°	8	12	30°	15° to 30°	5 to 11
Middle of the Road	8 to 32 mm	4	20°	11	12	30°	15° to 30°	6 to 14
Middle of the Road	8 to 32 mm	5	20°	13.5	12	30°	15° to 30°	8.5 to 18
Middle of the Road	8 to 32 mm	6	20°	16.5	12	30°	15° to 30°	10 to 22

*Note: The installation diagram is for reference only. The actual scenario and appearance may vary.

▪ **Available Model**

iDS-2CD7026G0/P-AP(C)

▪ **Dimension**

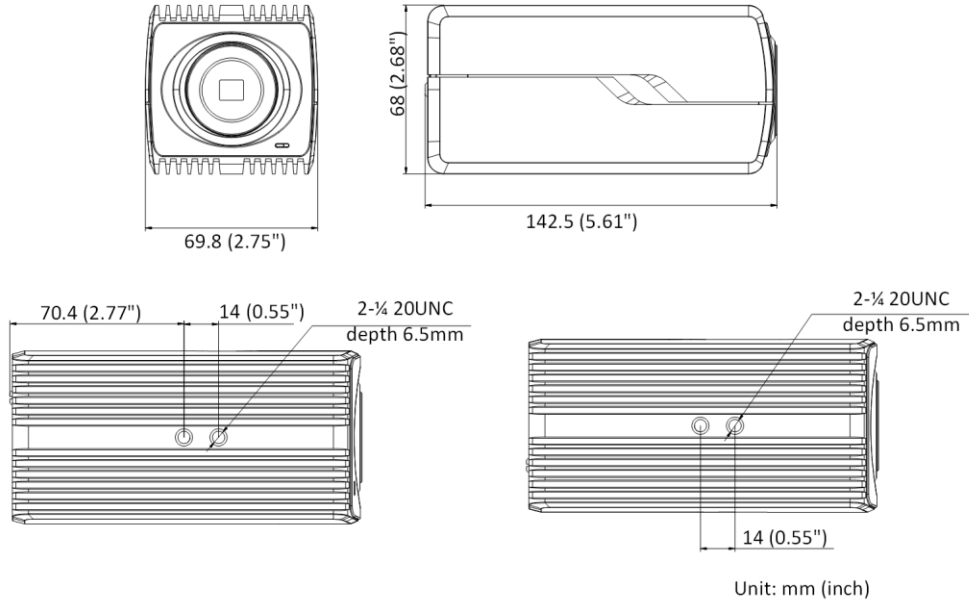

▪ **Accessory**

▪ **Optional**

DS-1292ZJ Wall mount	DS-1293ZJ Wall mount	DS-1299ZJ Pendant Mount	DS-1269ZJ Pendant Mount	DS-1214ZJ Horizontal pole mount
				
DS-1233ZJ Pendant Mount	DS-1332HZ Indoor Housing	DS-1331HZ-W Outdoor Housing	HV3816P-8MPIR Mega-pixel P-Iris Lens	HV1140P-8MPIR Mega-pixel P-Iris Lens
				
HV3816D-8MPIR Mega-pixel Auto-Iris Lens	HV1140D-8MPIR Mega-pixel Auto-Iris Lens	HV0733D-6MP Mega-pixel Auto-Iris Lens	HV0415D-MP Mega-pixel Auto-Iris Lens	DS-2202ZJ Wall mount
				

Headquarters

No.555 Qianmo Road, Binjiang District,
Hangzhou 310051, China
T +86-571-8807-5998
www.hikvision.com



Follow us on social media to get the latest product and solution information.

