



Network Box Camera

Quick Start Guide

Quick Start Guide

©2019 Hangzhou Hikvision Digital Technology Co., Ltd. All rights reserved.

This Manual is the property of Hangzhou Hikvision Digital Technology Co., Ltd. or its affiliates (hereinafter referred to as “Hikvision”), and it cannot be reproduced, changed, translated, or distributed, partially or wholly, by any means, without the prior written permission of Hikvision. Unless otherwise expressly stated herein, Hikvision does not make any warranties, guarantees or representations, express or implied, regarding to the Manual, any information contained herein.

About this Manual

The Manual includes instructions for using and managing the Product. Pictures, charts, images and all other information hereinafter are for description and explanation only. The information contained in the Manual is subject to change, without notice, due to firmware updates or other reasons. Please find the latest version of this Manual at the Hikvision website (<http://www.hikvision.com>).

Please use this Manual with the guidance and assistance of professionals trained in supporting the Product.

Trademarks Acknowledgement

HIKVISION and other Hikvision’s trademarks and logos are the properties of Hikvision in various jurisdictions.

Other trademarks and logos mentioned are the properties of their respective owners.

LEGAL DISCLAIMER

TO THE MAXIMUM EXTENT PERMITTED BY APPLICABLE LAW, THIS MANUAL AND THE PRODUCT DESCRIBED, WITH ITS HARDWARE, SOFTWARE AND FIRMWARE, ARE PROVIDED “AS IS” AND “WITH ALL FAULTS AND ERRORS”. HIKVISION MAKES NO WARRANTIES, EXPRESS OR IMPLIED, INCLUDING WITHOUT LIMITATION, MERCHANTABILITY, SATISFACTORY QUALITY, OR FITNESS FOR A PARTICULAR PURPOSE. THE USE OF THE PRODUCT BY YOU IS AT YOUR OWN RISK. IN NO EVENT WILL HIKVISION BE LIABLE TO YOU FOR ANY SPECIAL, CONSEQUENTIAL, INCIDENTAL, OR INDIRECT DAMAGES, INCLUDING, AMONG OTHERS, DAMAGES FOR LOSS OF BUSINESS PROFITS, BUSINESS INTERRUPTION, OR LOSS OF DATA, CORRUPTION OF SYSTEMS, OR LOSS OF DOCUMENTATION, WHETHER BASED ON BREACH OF CONTRACT, TORT (INCLUDING NEGLIGENCE), PRODUCT LIABILITY, OR OTHERWISE, IN CONNECTION WITH THE USE OF THE PRODUCT, EVEN IF HIKVISION HAS BEEN ADVISED OF THE POSSIBILITY OF SUCH DAMAGES OR LOSS.

YOU ACKNOWLEDGE THAT THE NATURE OF INTERNET PROVIDES FOR INHERENT SECURITY RISKS, AND HIKVISION SHALL NOT TAKE ANY RESPONSIBILITIES FOR ABNORMAL OPERATION, PRIVACY LEAKAGE OR OTHER DAMAGES RESULTING FROM CYBER-ATTACK, HACKER ATTACK, VIRUS INSPECTION, OR OTHER INTERNET SECURITY RISKS; HOWEVER, HIKVISION WILL PROVIDE TIMELY TECHNICAL SUPPORT IF REQUIRED.

YOU AGREE TO USE THIS PRODUCT IN COMPLIANCE WITH ALL APPLICABLE LAWS, AND YOU ARE SOLELY RESPONSIBLE FOR ENSURING THAT YOUR USE CONFORMS TO THE APPLICABLE LAW. ESPECIALLY, YOU ARE RESPONSIBLE, FOR USING THIS PRODUCT IN A MANNER THAT DOES NOT INFRINGE ON THE RIGHTS OF THIRD PARTIES, INCLUDING WITHOUT LIMITATION, RIGHTS OF PUBLICITY, INTELLECTUAL PROPERTY RIGHTS, OR DATA PROTECTION AND OTHER PRIVACY RIGHTS. YOU SHALL NOT USE THIS PRODUCT FOR ANY PROHIBITED END-USES, INCLUDING THE DEVELOPMENT OR PRODUCTION OF WEAPONS OF MASS DESTRUCTION, THE DEVELOPMENT OR PRODUCTION OF CHEMICAL OR BIOLOGICAL WEAPONS, ANY ACTIVITIES IN THE CONTEXT RELATED TO ANY NUCLEAR EXPLOSIVE OR UNSAFE NUCLEAR FUEL-CYCLE, OR IN SUPPORT OF HUMAN RIGHTS ABUSES.

IN THE EVENT OF ANY CONFLICTS BETWEEN THIS MANUAL AND THE APPLICABLE LAW, THE LATER PREVAILS.

Regulatory Information

FCC Information

Please take attention that changes or modification not expressly approved by the party responsible for compliance could void the user's authority to operate the equipment.

FCC compliance: This equipment has been tested and found to comply with the limits for a Class B digital device, pursuant to part 15 of the FCC Rules. These limits are designed to provide reasonable protection against harmful interference in a residential installation. This equipment generates, uses and can radiate radio frequency

energy and, if not installed and used in accordance with the instructions, may cause harmful interference to radio communications. However, there is no guarantee that interference will not occur in a particular installation. If this equipment does cause harmful interference to radio or television reception, which can be determined by turning the equipment off and on, the user is encouraged to try to correct the interference by one or more of the following measures:

- Reorient or relocate the receiving antenna.
- Increase the separation between the equipment and receiver.
- Connect the equipment into an outlet on a circuit different from that to which the receiver is connected.
- Consult the dealer or an experienced radio/TV technician for help

FCC Conditions

This device complies with part 15 of the FCC Rules. Operation is subject to the following two conditions:

1. This device may not cause harmful interference.
2. This device must accept any interference received, including interference that may cause undesired operation.

EU Conformity Statement



This product and - if applicable - the supplied accessories too are marked with "CE" and comply therefore with the applicable harmonized European standards listed under the EMC Directive 2014/30/EU, the RoHS Directive 2011/65/EU.



2012/19/EU (WEEE directive): Products marked with this symbol cannot be disposed of as unsorted municipal waste in the European Union. For proper recycling, return this product to your local supplier upon the purchase of equivalent new equipment, or dispose of it at designated collection points. For more information see: www.recyclethis.info



2006/66/EC (battery directive): This product contains a battery that cannot be disposed of as unsorted municipal waste in the European Union. See the product documentation for specific battery information. The battery is marked with this symbol, which may include lettering to indicate cadmium (Cd), lead (Pb), or mercury (Hg). For proper recycling, return the battery to your supplier or to a designated collection point. For more information see: www.recyclethis.info

Industry Canada ICES-003 Compliance

This device meets the CAN ICES-3 (B)/NMB-3(B) standards requirements.



Safety Instruction

These instructions are intended to ensure that user can use the product correctly to avoid danger or property loss.

The precaution measure is divided into “Warnings” and “Cautions”

Warnings: Serious injury or death may occur if any of the warnings are neglected.

Cautions: Injury or equipment damage may occur if any of the cautions are neglected.

	
Warnings Follow these safeguards to prevent serious injury or death.	Cautions Follow these precautions to prevent potential injury or material damage.



Warnings

- For device with this sticker, this device is intended for installation in a restricted access location, access can only be gained by service persons or by users who have been instructed about the reasons for the restrictions applied to the location and about any precautions that shall be taken.
- Proper configuration of all passwords and other security settings is the responsibility of the installer and/or end-user.
- In the use of the product, you must be in strict compliance with the electrical safety regulations of the nation and region. Please refer to technical specifications for detailed information.
- The input voltage should conform to IEC60950-1 standard: SELV (Safety Extra Low Voltage) and the Limited Power Source. Refer to the appropriate documentation for detailed information.
- It is permitted to use ancillary equipment (e.g. A UPS) to meet the requirements of this clause. This shall be detailed in the test report and the manufacturer's installation manual.



- Do not connect several devices to one power adapter as adapter overload may cause over-heating or a fire hazard.
- Please make sure that the plug is firmly connected to the power socket. When the product is mounted on wall or ceiling, the device shall be firmly fixed.
- If smoke, odor or noise rise from the device, turn off the power at once and unplug the power cable, and then please contact the service center.



Cautions

- If the camera fails to synchronize the local time with that of the network, you need to set the camera time manually. Visit the camera (via web browser or client software) and enter the system settings interface for the time settings.
- Make sure the power supply voltage is correct before using the camera.
- Do not drop the camera or subject it to physical shock.
- Do not touch sensor modules with fingers. If cleaning is necessary, use clean cloth with a bit of ethanol and wipe it gently. If the camera will not be used for an extended period, please replace the lens cap to protect the sensor from dirt.
- Do not aim the camera at the sun or extra bright places. Blooming or smearing may occur otherwise (which is not a malfunction), and affect the endurance of sensor at the same time.

- The sensor may be burned out by a laser beam, so when any laser equipment is in using, make sure that the surface of sensor will not be exposed to the laser beam.
- Do not place the camera in extremely hot, cold (the operating temperature shall be -30 °C to +60 °C or -30 °C to +45 °C, dusty or damp locations, and do not expose it to high electromagnetic radiation. Refer to the specification for detailed operating temperature.
- To avoid heat accumulation, good ventilation is required for operating environment.
- Keep the camera away from liquid while in use.
- While in delivery, the camera shall be packed in its original packing, or packing of the same texture.
- Regular part replacement: a few parts (e.g. electrolytic capacitor) of the equipment shall be replaced regularly according to their average enduring time. The average time varies because of differences between operating environment and using history, so regular checking is recommended for all the users. Please contact with your dealer for more details.
- Improper use or replacement of the battery may result in hazard of explosion. Replace with the same or equivalent type only. Dispose of used batteries according to the instructions provided by the battery manufacturer. L'utilisation ou le remplacement inadéquats de la pile peuvent entra?ner un risque d'explosion. Remplacez-la par le même type ou l'équivalent du même type seulement. Jetez les piles usagées conformément aux directives fournies par le fabricant de la pile.

- If the product does not work properly, please contact your dealer or the nearest service center. Never attempt to disassemble the camera yourself. (We shall not assume any responsibility for problems caused by unauthorized repair or maintenance.)

Table of Contents

1 Appearance	11
2 Installation	14
2.1 (Optional) TF/4G Card Installation	14
2.2 Lens Installation	15
2.3 Camera Mounting	18
2.3.1 Pendant Mounting	18
2.3.2 Wall Mounting.....	20
2.3.3 Housing Mounting.....	22
2.3.4 Connect Cables.....	24
2.3.5 Sun Shield Mounting	27
2.4 Zoom and Focus Adjustment.....	28
3 Setting the Network Camera over the LAN	30
3.1 Wiring	30
3.2 Activating the Camera	31
3.2.1 Activation via Web Browser.....	31
3.2.2 Activation via SADP Software	32
3.3 Modifying the IP Address	34
4 Accessing via Web Browser	37
5 Operating via Hik-Connect App	39
5.1 Enable Hik-Connect Service on Camera.....	39
5.1.1 Enable Hik-Connect Service via SADP Software ..	39
5.1.2 Enable Hik-Connect Service via Web Browser	40
5.2 Hik-Connect Setup	42
5.3 Adding Camera to Hik-Connect	42
5.4 Initializing the Memory Card.....	44

1 Appearance

The overview of the box camera is shown below:

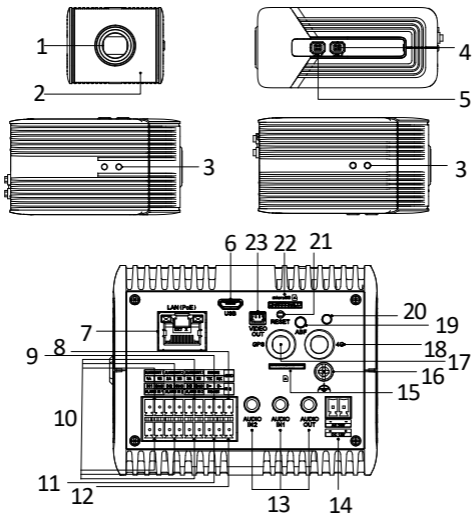

Figure 1-1 Overview

Table 1-1 Description

No.	Description	No.	Description
1	Lens Mount	2	Microphone
3	¼-20 UNC Screw Hole	4	Lens_D
5	Lens_P	6	USB
7	LAN (PoE 802.3af)	8	Grounding
9	RS-232	10	Alarm Interface
11	RS-485	12	N/A
13	Audio Interface	14	Power Interface
15*	4G SIM Card Slot	16	Grounding Screw
17*	GPS Interface	18*	4G Interface
19*	ABF (Auto Back Focus)	20	LED
21	Reset Button	22	TF Card Slot
23	Video Output Interface		

Note:

- The interface marked with * means it is only supported by certain models.
- To reset the camera default parameters, you need to press and hold the RESET button and power on the camera. After the power

on of the camera, you must still press and hold the Reset button for about 10 seconds.

2 Installation

Before you start:

- Make sure the device in the package is in good condition and all the assembly parts are included.
- The standard power supply is 12 VDC or 24 VAC or PoE (Refer to the specification for detailed information), please make sure your power supply matches with your camera.
- Make sure all the related equipment is power-off during the installation.
- Check the specification of the products for the installation environment.
- Make sure that the wall is strong enough to withstand four times the weight of the camera and the bracket.
- For the camera that supports IR, you are required to pay attention to the following precautions to prevent IR reflection: Make sure that there is no reflective surface too close to the camera lens. The IR light from the camera may reflect back into the lens causing reflection.

2.1 (Optional) TF/4G Card Installation

Notes:

4G card installation is only supported by certain models.

Steps:

1. Insert the TF/4G card into the slot on the rear panel of the camera.
2. (Optional) If you want to unmount the card, push to get it ejected.

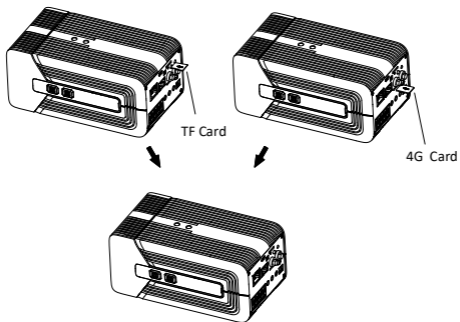

Figure 2-1 Card Installation

2.2 Lens Installation

Before you start:

The lens shown below is only for demonstration.

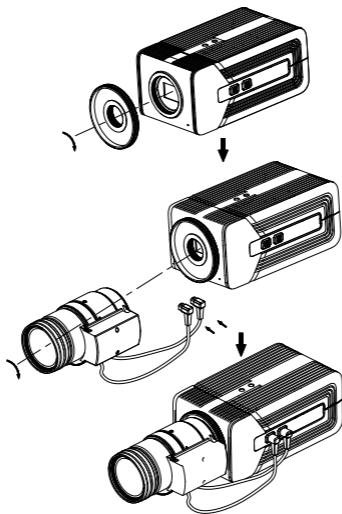

Figure 2-2 Lens Installation (M42 to C-mount Adapter)

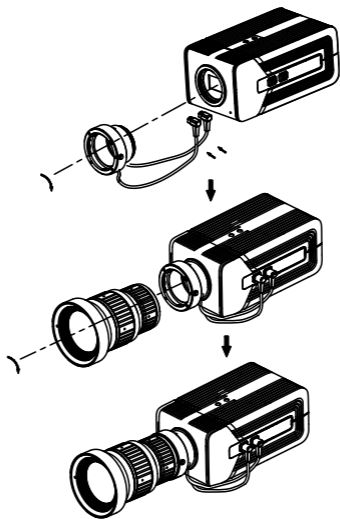

Figure 2-3 Lens Installation (M42 to F-mount Adapter)

Steps:

1. Install the lens adapter to the lens interface of the camera.
2. Install the lens (not supplied) to the camera and rotate it to get it tightened.
3. Plug the cables to the corresponding interfaces.

2.3 Camera Mounting

2.3.1 Pendant Mounting

Before you start:

The pendant mount is not supplied and should be purchased separately.

Steps:

1. Install the pendant mount to the ceiling with the supplied screws.

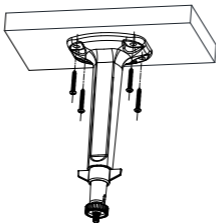

Figure 2-4 Install the Mount

2. Screw the camera to the pendant mount and tighten the adjusting knob.

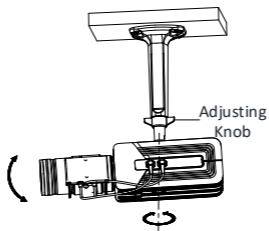
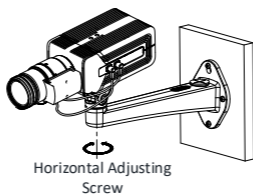

Figure 2-5 Install the Camera to the Mount

3. Adjust viewing angle



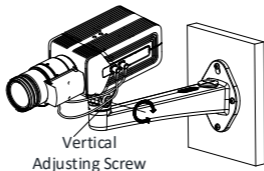

Figure 2-6 Adjust Viewing Angle

- 1). Loosen the horizontal and vertical adjusting screws.
- 2). Adjust the angle.
- 3). Tighten the screws.

2.3.2 Wall Mounting

Before you start:

The wall mount is not supplied and should be purchased separately.

Steps:

1. Separate the pedestal from the wall mount.

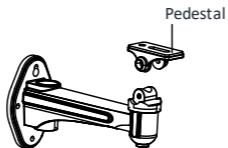

Figure 2-7 Separate Pedestal

2. Fix the pedestal to camera body.

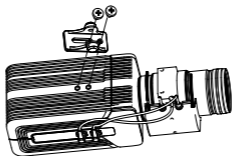

Figure 2-8 Fix Pedestal to Camera

3. Install the wall mount to wall.

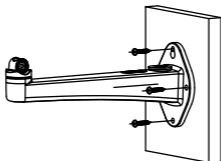

Figure 2-9 Install the Wall Mount

4. Install the pedestal together with the camera back to wall mount.

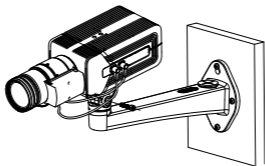

Figure 2-10 Install Camera to Wall Mount

5. Adjust the viewing angle. Refer to step 3 in Pendant Mounting for details.

2.3.3 Housing Mounting

Before you start:

The shown housing is not included in package. You need to prepare one if you adopt this mounting style.

Also, for housing mounting, you need to prepare suitable brackets in advance.

If using brackets, the housing supports wall mounting, pole mounting, and pendant mounting. The brackets are shown in the figures below:

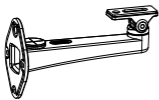

Wall Mount



Horizontal Pole Mount

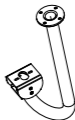

Pendant Mount

1. Install the bracket onto the wall/ceiling/pole. The wall mounting bracket, pole mounting bracket, and the pendent bracket are shown in the figures below.

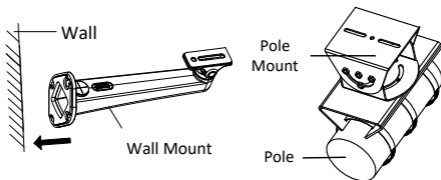

Figure 2-11 Install the Bracket to Mounting Place (1)

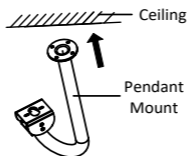

Figure 2-12 Install the Bracket to Mounting Place (2)

2. Fix the housing (with camera) onto the bracket with the supplied screws.
3. Loosen the adjusting screw to adjust the viewing angle of the camera. Tighten the screw after adjustment.

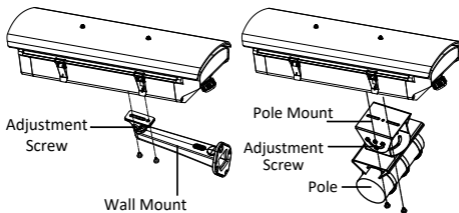

Figure 2-13 Fix the Housing to Brackets (1)

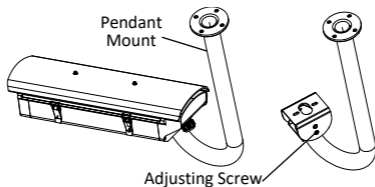

Figure 2-14 Fix the Housing to Brackets (2)

4. Adjust zoom and focus. Refer to Section 2.4.

2.3.4 Connect Cables

Purpose:

If the camera is installed outdoor, you can use supplied waterproof tape to protect cables after the camera is secured on the installation surface.

1. Unscrew the tighten nut at the end of the shield and remove the silicone ring.

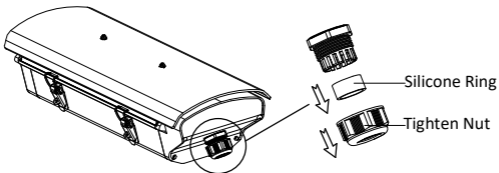

Figure 2-15 Remove the Silicone Ring

2. Select a proper silicone ring according to the number of cables.
3. Insert the cable into the silicone ring from the opening of the silicone ring.

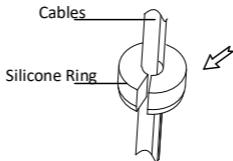

Figure 2-16 Insert the Cables

4. Open the shield and connect the cables inside the shield according to Figure 1-1.
5. Refer to step 4 in Section 2.4 for ABF adjustment.
6. Lock the shield.
7. Fix the tighten nut.

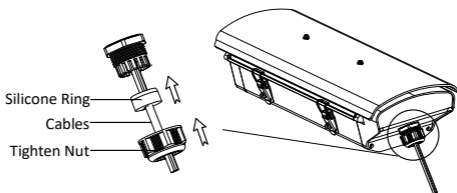

Figure 2-17 Fix the Tighten Nut

8. Install the waterproof tape.

- 1). Tear off the release paper on the back of the waterproof tape.
- 2). Stretch the waterproof tape to reach twice the initial length.

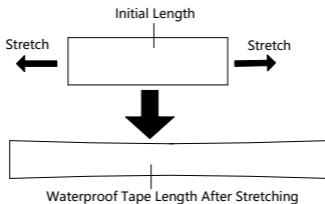

Figure 2-18 Stretch the Waterproof Tape

- 3). Wrap the waterproof tape around the cables and nut tightly.

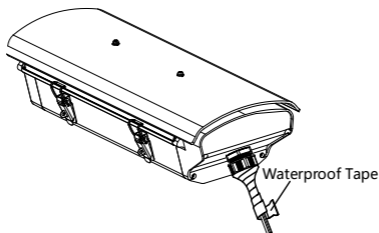

Figure 2-19 Wrap the Waterproof Tape

Note:

Make sure that all naked wires are all firmly wrapped in the waterproof tape.

2.3.5 Sun Shield Mounting

Some models need to be installed with sun shield. The specific installation steps are as follows:

1. Fix the cushion column to the shield upper cover.
2. Fix the sun shield with screws.

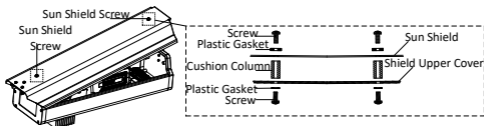

Figure 2-20 Fix the Sun Shield

3. Lock the sun shield.

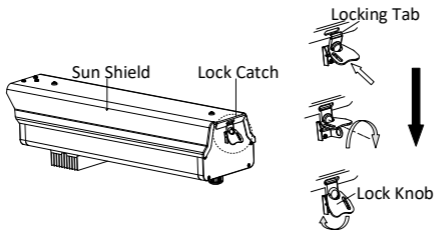

Figure 2-21 Lock the Sun Shield

2.4 Zoom and Focus Adjustment

Steps:

1. Power on the camera.
2. Connect the video out interface of the camera to the installation display device.
3. Adjust zoom and focus.
 - For certain camera models, zoom and focus must be manually adjusted via zoom/focus lever according to the image on the display device.

Note:

For the camera equipped with the auto iris, it is suggested you change the iris mode to manual from the camera menu (accessed via web browser), and re-change it back to auto iris after you adjust the focus by the focus lever.

- For camera equipped with a motor-driven lens, adjust the zoom and focus on PTZ control panel by visiting the camera via web browser or client software.
4. (Optional) For the camera supports ABF, you can adjust the focus manually, or click the ABF button on the rear panel of the camera to adjust the focus automatically.

3 Setting the Network Camera over the LAN

Note:

You shall acknowledge that the use of the product with Internet access might be under network security risks. For avoidance of any network attacks and information leakage, please strengthen your own protection.

If the product does not work properly, contact your dealer or the nearest service center for help.

3.1 Wiring

Connect the camera to network according to the following figures.

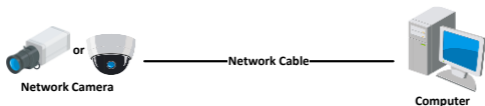

Figure 3-1 Connecting Directly

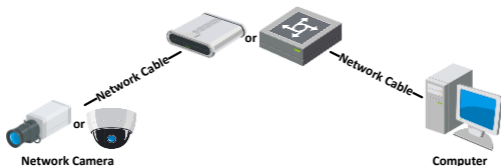

Figure 3-2 Connecting via a Switch or a Router

3.2 Activating the Camera

You are required to activate the camera first by setting a strong password for it before you can use the camera.

Activation via Web Browser, Activation via SADP, and Activation via Client Software are all supported. We will take activation via SADP software and Activation via Web Browser as examples to introduce the camera activation.

Note:

Refer to the User Manual of Network Camera for Activation via Client Software.

3.2.1 Activation via Web Browser

Steps:

1. Power on the camera. Connect the camera to your computer or the switch/router which your computer connects to.
2. Input the IP address into the address bar of the web browser, and press Enter to enter the activation interface.

Notes:

- The default IP address of the camera is 192.168.1.64.
- The computer and the camera should belong to the same subnet.
- For the camera enables the DHCP by default, you need to use the SADP software to search the IP address.

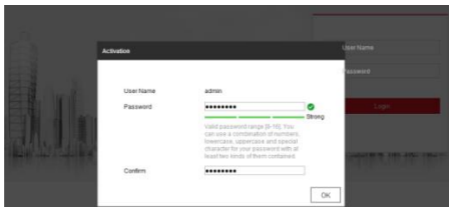

Figure 3-3 Activation Interface (Web)

3. Create a password and input the password into the password field.



STRONG PASSWORD RECOMMENDED— *We highly recommend you create a strong password of your own choosing (using a minimum of 8 characters, including upper case letters, lower case letters, numbers, and special characters) in order to increase the security of your product. And we recommend you reset your password regularly, especially in the high security system, resetting the password monthly or weekly can better protect your product.*

4. Confirm the password.
5. Click **OK** to save the password and enter the live view interface.

3.2.2 Activation via SADP Software

SADP software is used for detecting the online device, activating the camera, and resetting the password.

Get the SADP software from the supplied disk or the official website, and install the SADP according to the prompts.

Network Box Camera ▪ Quick Start Guide

Follow the steps to activate the camera.

Steps:

1. Run the SADP software to search the online devices.
2. Check the device status from the device list, and select the inactive device.

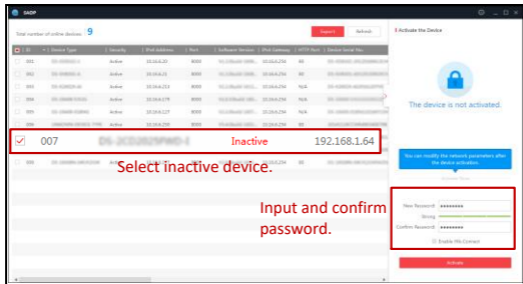

Figure 3-4 SADP Interface

Note:

The SADP software supports activating the camera in batch. Refer to the user manual of SADP software for details.

3. Create and input the new password in the password field, and confirm the password.



STRONG PASSWORD RECOMMENDED– *We highly recommend you create a strong password of your own choosing (using a minimum of 8 characters, including upper case letters, lower case letters, numbers, and special characters) in order to increase the security of your product. And we recommend you reset your password regularly, especially in the high security system, resetting the password monthly or weekly can better protect your product.*

Note:

You can enable the Hik-Connect service for the device during activation. Refer to Chapter 5.1 for detailed information.

4. Click **Activate** to start activation.

You can check whether the activation is completed on the popup window. If activation failed, make sure that the password meets the requirement and try again.

3.3 Modifying the IP Address

Purpose:

To view and configure the camera via LAN (Local Area Network), you need to connect the network camera in the same subnet with your PC.

Use the SADP software or client software to search and change the IP address of the device. We take modifying the IP Address via SADP software as an example to introduce the IP address modification.

For IP address modification via client software, refer to the user manual of client software.

Steps:

1. Run the SADP software.
2. Select an active device.
3. Change the device IP address to the same subnet with your computer by either modifying the IP address manually or checking **Enable DHCP**.

Modify Network Parameters

Enable DHCP
 Enable Hik-Connect

Device Serial No.:

IP Address:

Port:

Subnet Mask:

Gateway:

IPv6 Address:

IPv6 Gateway:

IPv6 Prefix Length:

HTTP Port:

Security Verification

Admin Password:

Modify

[Forgot Password](#)

Figure 3-5 Modify the IP Address

Note:

You can enable the Hik-Connect service for the device during activation. Refer to Chapter 5.1 for detailed information.

4. Input the admin password and click **Modify** to activate your IP address modification.

The batch IP address modification is supported by the SADP. Refer to the user manual of SADP for details.

4 Accessing via Web Browser

System Requirement:

Operating System: Microsoft Windows XP SP1 and above version

CPU: 2.0 GHz or higher

RAM: 1G or higher

Display: 1024×768 resolution or higher

Web Browser: Internet Explorer 8.0 and above version, Apple Safari 5.0.2 and above version, Mozilla Firefox 5.0 and above version and Google Chrome 18 to 42.

Steps:

1. Open the web browser.
2. In the browser address bar, input the IP address of the network camera, and press the **Enter** key to enter the login interface.

Note:

- The default IP address is 192.168.1.64. You are recommended to change the IP address to the same subnet with your computer.

3. Input the user name and password.

The admin user should configure the device accounts and user/operator permissions properly. Delete the unnecessary accounts and user/operator permissions.

Note:

The device IP address gets locked if the admin user performs 7 failed password attempts (5 attempts for the user/operator).

4. Click **Login**.



Figure 4-1 Login Interface

5. Download and install appropriate plug-in for your web browser.

For IE based web browser, webcomponents and QuickTime™ are optional. For non-IE based web browser, webcomponents, QuickTime™, VLC and MJPEG are optional.

Note:

You may have to close the web browser to finish the installation of the plug-in.

6. Reopen the web browser after the installation of the plug-in and repeat steps 2 to 4 to login.

Note:

For detailed instructions of further configuration, please refer to the user manual of network camera.

5 Operating via Hik-Connect App

Purpose:

Hik-Connect is an application for mobile devices. With the App, you can view live image of the camera, receive alarm notification and so on.

Note:

Hik-Connect service is not supported by certain camera models.

5.1 Enable Hik-Connect Service on Camera

Purpose:

Hik-Connect service should be enabled on your camera before using the service.

You can enable the service through SADP software or web browser.

5.1.1 Enable Hik-Connect Service via SADP Software

Steps:

1. Check **Enable Hik-Connect**:

- 1). "Activate the Device" page during camera activation, refer to Chapter 3.2.2.
- 2). Or "Modify Network Parameters" page during modifying IP address, refer to Chapter 3.3.

2. Create a verification code or change the verification code.

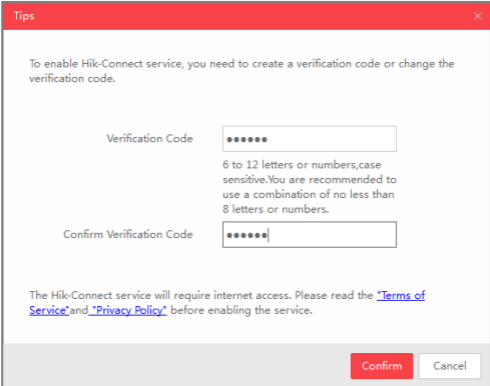

The screenshot shows a dialog box titled "Tips" with a red header and a close button (X) in the top right corner. The main text reads: "To enable Hik-Connect service, you need to create a verification code or change the verification code." Below this, there are two input fields. The first is labeled "Verification Code" and contains six dots. To its right, text specifies: "6 to 12 letters or numbers, case sensitive. You are recommended to use a combination of no less than 8 letters or numbers." The second input field is labeled "Confirm Verification Code" and contains six dots followed by a vertical cursor. At the bottom of the dialog, there are two buttons: "Confirm" (red) and "Cancel" (white).

Figure 5-1 Verification Code Setting (SADP)

Note:

The verification code is required when you add the camera to Hik-Connect app.

3. Click and read "Terms of Service" and "Privacy Policy".
4. Confirm the settings.

5.1.2 Enable Hik-Connect Service via Web Browser

Before you start:

You need to activate the camera before enabling the service. Refer to Chapter 3.2.

Steps:

1. Access the camera via web browser. Refer to Chapter 4.
2. Enter platform access configuration interface: **Configuration > Network > Advanced Settings > Platform Access.**

Enable

Platform Access Mode

Server IP Custom

Register Status

Verification Code

6 to 12 letters (a to z, A to Z) or numbers (0 to 9), case sensitive. You are recommended to use

Figure 5-2 Platform Access Configuration (Web)

3. Select **Platform Access Mode** to **Hik-Connect**.
4. Check **Enable**.
5. Click and read "Terms of Service" and "Privacy Policy" in pop-up window.
6. Create a verification code or change the verification code for the camera.

Note:

The verification code is required when you add the camera to Hik-Connect app.

7. Save the settings.

5.2 Hik-Connect Setup

Steps:

1. Download and install the Hik-Connect app by searching “Hik-Connect” in App Store or Google Play™.
2. Launch the app and register for a Hik-Connect user account.
3. Log in Hik-Connect app after registration.

5.3 Adding Camera to Hik-Connect

Before you start:

You need to enable the Hik-Connect service on camera before adding it to your Hik-Connect account. Refer to Chapter 5.1.

Steps:

1. Use a network cable to connect the camera with a router if the camera does not support Wi-Fi.



Figure 5-3 Connect a Router

Note:

After the camera connects to the network, please wait one minute before any operation on the camera using Hik-Connect app.

2. In the Hik-Connect app, tap “+” on the upper-right corner and then scan the QR code of the camera to add the camera.

You can find the QR code on the camera or on the cover of the Quick Start Guide of the camera in the package.

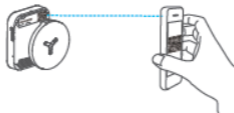



Figure 5-4 Scan QR Code

Note:

If the QR code is missing or too blur to be recognized, you can also add the camera by tapping the  icon and inputting the camera's serial number.

3. Input the verification code of your camera.

Note:

- The required verification code is the code you create or change when you enabling Hik-Connect service on camera.
- If you forget the verification code, you can check the current verification code on **Platform Access** configuration page via web browser.

4. Follow the prompts to set the network connection and add the camera to your Hik-Connect account.

Note:

For detailed information, refer to the user manual of the Hik-Connect app.

5.4 Initializing the Memory Card

Steps:

Check the memory card status by tapping on the Storage Status in the Device Settings interface.

If the memory card status displays as Uninitialized, tap to initialize it. The status will then change to Normal. You can then start recording any event triggered video in the camera such as motion detection.

