

DS-2DP8A440IXG-LF/832(F0)(B) 360° Stitched 32 MP PanoVu Camera with PTZ

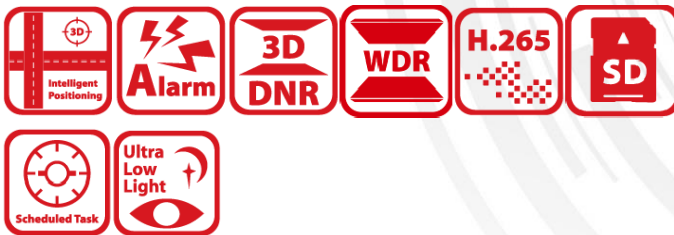

Hikvision DS-2DP3236ZIXS-D/440(F0)(P5) 360° Stitched 32 MP PanoVu Camera with PTZ is able to capture panoramic images as well as close-up images. The panoramic images are captured by 8 sensors for 360° panorama monitoring. The integration of two cameras can locate the details fast over expansive area. Furthermore, with advanced video analysis and multiple targets tracking algorithms, the PanoVu camera features a wide range of smart functions for multiple targets within the panoramic view, including intrusion detection, line crossing detection, region entrance detection, and region exiting detection. The camera can output alarm signals and link the PTZ for tracking to improve the security efficiency.

This product is suitable for the application scenarios that require expansive monitoring and detail capture, such as airports, stations, stadiums, playgrounds, scenic areas, and public squares.

Hikvision has been dedicated to develop products with security since established.

Hikvision always follows security by design principle and has adopted many methods of security technologies into our product development lifecycle, including terminal security, data security, application security, network security, and privacy protection. In the meantime, the security technologies used by Hikvision are all in compliance with local applicable laws and safety regulations. These security measures could enhance product's cyber security protection capability and protect your devices as well as your data from malicious cyber attacks.

- High quality imaging with 32 MP resolution, up to 2 × 5520 × 2400 @30 fps for panoramic channels
- Excellent low-light performance with DarkFighter technology
- 40x optical zoom and 16 × digital zoom provide close up views over expansive areas
- Expansive night view with up to 250 m IR distance
- With one click on the panoramic channel, the PTZ channel shows the details automatically
- Continuous and stable manual tracking, auto-tracking, and panorama tracking
- Automatic switch between multiple targets
- Supports 7 alarm inputs, 2 alarm outputs, 1 audio input, and 1 audio output

▪ Specification

Camera	
Image Sensor	[Panoramic channel]: 1/1.8" progressive scan CMOS, [PTZ channel]: 1/1.8" progressive scan CMOS
Max. Resolution	5520 × 2400
Min. Illumination	[Panoramic channel] Color: 0.0005 Lux (F1.0, AGC ON), B/W: 0.0001 Lux (F1.0, AGCON); [PTZ channel]: 0.0005 Lux (F1.2, AGC ON), B/W: 0.0001 Lux (F1.2, AGC ON), 0 Lux with IR
Shutter Speed	1 s to 1/30000 s
Auto Shutter	Yes
Day & Night	IR cut filter
Zoom	[PTZ channel] 40x optical, 16x digital
Slow Shutter	Yes
Lens	
Focal Length	[Panoramic channel] 2.8 mm; [PTZ channel] 6.0 to 240 mm
FOV	Horizontal FOV 56.6° to 1.8°, vertical FOV 33.7° to 1.0°, diagonal FOV 63.4° to 2.0°
Focus	Auto, semi-auto, manual, rapid focus
Iris	Auto-iris
Aperture	Max. F1.0
Zoom Speed	[PTZ channel] Approx. 5.6 s
Illuminator	
Supplement Light Type	IR
Supplement Light Range	Up to 250 m
Smart Supplement Light	Yes
PTZ	
Movement Range (Pan)	360°
Movement Range (Tilt)	-15° to 90° (auto flip)
Pan Speed	Pan speed: configurable from 0.1° to 210°/s; preset speed: 240°/s
Tilt Speed	Tilt speed: configurable from 0.1° to 150°/s, preset speed 200°/s
Proportional Pan	[Panoramic channel]: no; [PTZ channel]: yes
Presets	300
Preset Freezing	Yes
Patrol Scan	8 patrols, up to 32 presets for each patrol
Pattern Scan	4 pattern scans, record time over 10 minutes for each scan
Park Action	Preset, pattern scan, patrol scan, auto scan, tilt scan, random scan, frame scan, panorama scan
3D Positioning	Yes
PTZ Status Display	Yes
Scheduled Task	Preset, pattern scan, patrol scan, auto scan, tilt scan, random scan, frame scan, panorama scan, dome reboot, dome adjust, aux output
Power-off Memory	Yes

Video	
Main Stream	[Panoramic channel]: 50 Hz: 25 fps (5520×2400×2, 4096×1800×2, 3840×1680×2, 2784×1200×2) 60 Hz: 30 fps (5520×2400×2, 4096×1800×2, 3840×1680×2, 2784×1200×2) [PTZ channel]: 50 Hz: 25 fps (2560 × 1440, 1920 × 1080, 1280 × 960, 1280 × 720) 60 Hz: 30 fps (2560 × 1440, 1920 × 1080, 1280 × 960, 1280 × 720)
Sub-Stream	[Panoramic channel]: 50 Hz: 25 fps (3072 × 1280, 1560 × 656, 704 × 320) 60 Hz: 30 fps (3072 × 1280, 1560 × 656, 704 × 320) [PTZ channel]: 50 Hz: 25 fps (704 × 576, 640 × 480, 352 × 288); 60 Hz: 30 fps (704 × 480, 640 × 480, 352 × 240)
Third Stream	[Panoramic channel]: 50 Hz: 25 fps (3072 × 1280, 2784×1200) 60 Hz: 30 fps (3072 × 1280, 2784×1200) Enabling the third stream on the panoramic channel will reduce the sub-stream resolution [PTZ channel]: 50 Hz: 25 fps (1920 × 1080, 1280 × 960, 1280 × 720, 704 × 576, 640 × 480, 352 × 288) 60 Hz: 30 fps (1920 × 1080, 1280 × 960, 1280 × 720, 704 × 480, 640 × 480, 352 × 240)
Video Compression	Main stream: H.265+/H.265/H.264+/H.264Sub-stream: H.265/H.264/MJPEG Third stream: H.265/H.264/MJPEG
Audio	
Audio Compression	G.711alaw, G.711ulaw, G.722.1, G.726, MP2L2, AAC, PCM
Audio Sampling Rate	PCM: 8 kHz, 16 kHz, 32 kHz, 48 kHz; MP2L2: 16 kHz, 32 kHz, 48 kHz; AAC: 16 kHz, 32 kHz, 48 kHz
Network	
Protocols	IPv4/IPv6, HTTP, HTTPS, 802.1x, QoS, FTP, SMTP, UPnP, SNMP, DNS, DDNS, NTP, RTSP, RTCP, RTP, TCP/IP, UDP, IGMP, ICMP, DHCP, PPPoE, Bonjour, TLS/SSL
Simultaneous Live View	Up to 20 channels
API	Open Network Video Interface (Profile S, Profile G, Profile T, Profile M), ISAPI, SDK, ISUP
User/Host	Up to 32 users. 3 user levels: administrator, operator, and user
Security	Password protection, complicated password, HTTPS encryption, 802.1X authentication (EAP-TLS, EAP-LEAP, EAP-MD5), watermark, IP address filter, basic and digest authentication for HTTP/HTTPS, WSSE and digest authentication for Open Network Video Interface, RTP/RTSP over HTTPS, control timeout settings, security audit log, TLS/SSL 1.3, host authentication (MAC address), TPM 2.0 (FIPS 140 -2 level 2), AES 128
Network Storage	NAS (NFS, SMB/CIFS), ANR
Client	iVMS-4200, HikCentral Pro, Hik-Connect
Web Browser	IE10-11, Chrome 57+, Firefox 52+, Safari 12+
Image	
Image Parameters Switch	Yes
Image Settings	Saturation, brightness, contrast, sharpness, gain (AGC), and white balance (AWB) adjustable by client software or web browser
Day/Night Switch	Day, night, auto, scheduled-switch
Wide Dynamic Range (WDR)	[Panoramic channel] no, [PTZ channel] 120 dB
SNR	≥ 55 dB
Defog	[Panoramic channel]: no; [PTZ channel]: optical defog
Image Stabilization	EIS
Image Enhancement	BLC, HLC, 3D DNR

Privacy Mask	Programmable polygon privacy masks (8 for panoramic channel, 24 for PTZ channel), mask color or mosaic configurable
Regional Focus	Yes
Regional Exposure	Yes
Interface	
Ethernet Interface	1 RJ45 10M/100M/1000M self-adaptive Ethernet port
On-board Storage	Built-in memory card slot, support microSD/microSDHC/microSDXC cards, up to 256 GB
Audio	1 input (line in), max. input amplitude: 2-2.4 vpp, input impedance: 1 K Ω \pm 10%; 1 output (line out), line level, output impedance: 600 Ω
Alarm	7 alarm inputs, 2 alarm outputs
RS-485	1 RS-485 (Half duplex, HIKVISION, Pelco-P, Pelco-D, self-adaptive)
Reset	Yes
Fiber Optical	1 FC interface, built-in fiber module, 1000M, TX1310/RX1550 nm wavelength, single module fiber, up to 20 km transmission distance
Event	
Smart Event	Line crossing detection, region entrance detection, region exiting detection, unattended baggage detection, object removal detection, intrusion detection
Linkage	Upload to FTP/NAS/memory card, notify surveillance center, send email, trigger alarm output, trigger recording, and PTZ actions (such as preset, patrol scan, pattern scan)
Smart Tracking	Manual tracking, auto-tracking, Support patrol tracking among multiple detection Scenes
Deep Learning Function	
Face Capture	[Panoramic channel] no,[PTZ channel] yes
People Density	[Panoramic channel]: yes ,[PTZ channel]: no
Multi-Target-Type Detection	Supports simultaneous detection and capture of human body, face and vehicle,[Bullet channel] no
General	
Power	36 VDC, max. 135 W (including max. 12 W for IR)
Dimension	\varnothing 433.5 mm x 430.4 mm (\varnothing 17.07" x 16.94")
Weight	Approx. 18 kg (39.68 lb.)
Material	ADC12
Operating Condition	-40°C to 70°C (-40°F to 158 °F). Humidity 90% or less (non-condensing)
Wiper	No
Demist	Yes
Approval	
Safety	UL (UL 62368-1); CB (IEC 62368-1: 2014+A11); CE-LVD (EN 62368-1:2014/A11:2017); BIS (IS 13252 (Part 1): 2010/IEC 60950-1: 2005); LOA (IEC/EN 60950-1)
Environment	CE-RoHS (2011/65/EU); WEEE (2012/19/EU); Reach (Regulation (EC) No 1907/2006)
Protection	IP67 Standard, Lightning Protection, Surge Protection and Voltage Transient Protection, \pm 6kV Line to Gnd, \pm 3kV Line to Line, IEC61000-4-5, IK10

▪ **DORI**

The DORI (detect, observe, recognize, identify) distance gives the general idea of the camera ability to distinguish persons or objects within its field of view. It is calculated based on the camera sensor specification and the criteria given by EN 62676-4: 2015.

DORI	Detect	Observe	Recognize	Identify
Definition	25 px/m	63 px/m	125 px/m	250 px/m
[Panoramic channel] Distance	38.6 m (126.6 ft.)	15.3 m (50.2 ft.)	7.7 m (25.3 ft.)	3.9 m (12.8 ft.)
[PTZ channel] Distance (Tele)	4137.9 m (13575.8 ft.)	1642.0 m (5387.1 ft.)	827.6 m (2715.2 ft.)	413.8 m (1357.6 ft.)

▪ **Available Model**

DS-2DP8A440IXG-LF/832(F0)(B)

▪ **Dimension**

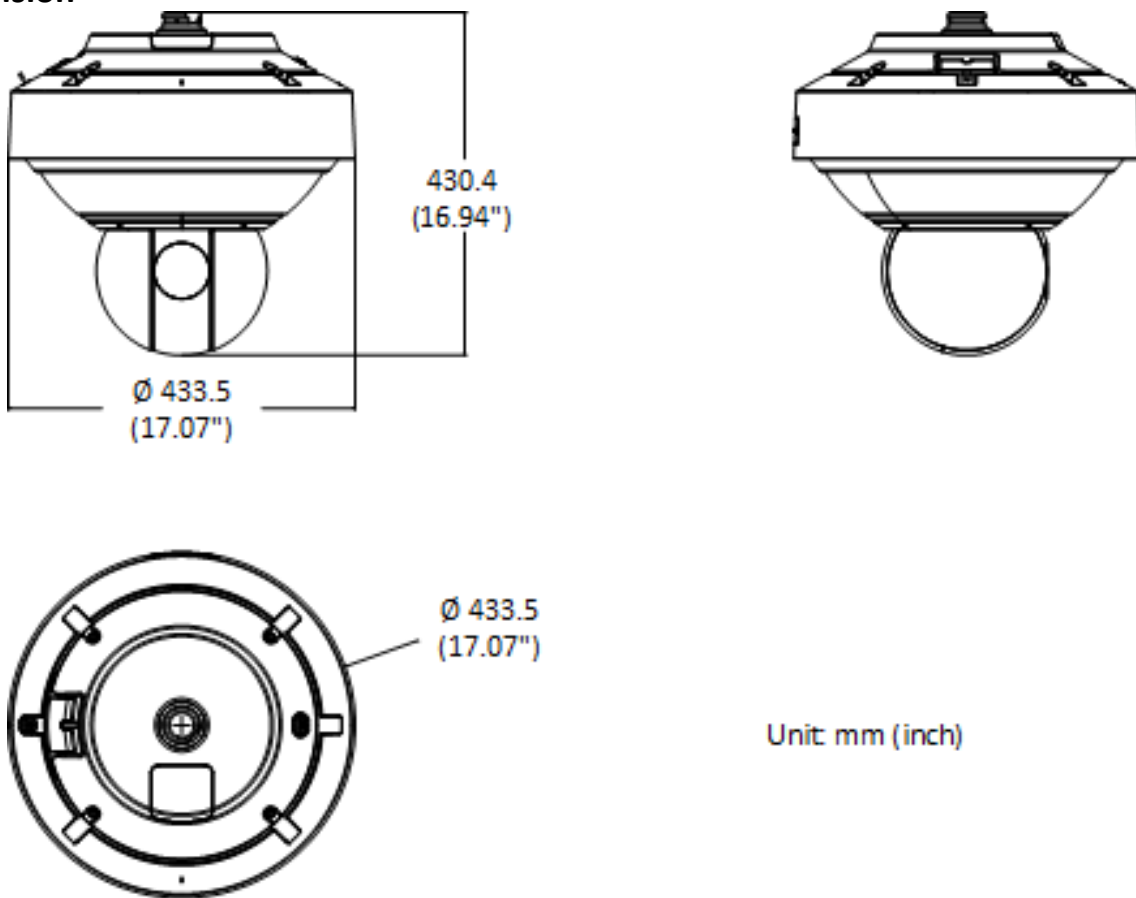















Unit: mm (inch)

▪ **Accessory**

▪ **Optional**

DS-1603ZJ-P Wall mount	DS-1668ZJ-P Pendant Mount	DS-1668ZJ(20)-P Pendant Mount	DS-1673ZJ-P Vertical pole mount	DS-1603ZJ-Pole-P Vertical pole mount
---------------------------	------------------------------	----------------------------------	------------------------------------	---

				
				
DS-1619ZJ-HP2 Others	DS-1684ZJ-P Vertical pole mount			
				
				

Headquarters

No.555 Qianmo Road, Binjiang District,
Hangzhou 310051, China
T +86-571-8807-5998
www.hikvision.com



Follow us on social media to get the latest product and solution information.

