



HD Turret and Bullet Camera

User Manual

User Manual

Thank you for purchasing our product. If there are any questions, or requests, do not hesitate to contact the dealer.

This manual applies to the models below:

Type	Model
Type I Camera	THC-T110-P/THC-T110 THC-T120-P/THC-T120
Type II Camera	THC-T210-P THC-T220-P
Type III Camera	THC-T110-M THC-T120-M
Type IV Camera	THC-T210-M THC-T220-M
Type V Camera	THC-B210/THC-B210-M THC-B220/THC-B220-M
Type VI Camera	THC-B110/THC-B110-P THC-B120/THC-B120-P

This manual may contain several technical incorrect places or printing errors, and the content is subject to change without notice. The updates will be added to the new version of this manual. We will readily improve or update the products or procedures described in the manual.

Regulatory Information

FCC Information

Please take attention that changes or modification not expressly approved by the party responsible for compliance could void the user's authority to operate the equipment.

FCC compliance: This equipment has been tested and found to comply with the limits for a Class A digital device, pursuant to part 15 of the FCC Rules. These limits are designed to provide reasonable protection against harmful interference when the equipment is operated in a commercial environment. This equipment generates, uses, and can radiate radio frequency energy and, if not installed and used in accordance with the instruction manual, may cause harmful interference to radio communications. Operation of this equipment in a residential area is likely to cause harmful interference in which case the user will be required to correct the interference at his own expense.

FCC Conditions

This device complies with part 15 of the FCC Rules. Operation is subject to the following two conditions:

1. This device may not cause harmful interference.
2. This device must accept any interference received, including interference that may cause undesired operation.

EU Conformity Statement



This product and - if applicable - the supplied accessories too are marked with "CE" and comply therefore with the applicable harmonized European

standards listed under the Low Voltage Directive 2014/35/EU, the EMC Directive 2014/30/EU.

2012/19/EU (WEEE directive): Products



marked with this symbol cannot be disposed of as unsorted municipal waste in the European Union. For proper recycling, return this product to your local supplier upon the purchase of equivalent new

equipment, or dispose of it at designated collection points. For more information see: www.recyclethis.info.

2006/66/EC (battery directive): This product contains a



battery that cannot be disposed of as unsorted municipal waste in the European Union. See the product documentation for specific battery information. The battery is marked with this symbol, which may

include lettering to indicate cadmium (Cd), lead (Pb), or mercury (Hg). For proper recycling, return the battery to your supplier or to a designated collection point. For more information see: www.recyclethis.info.

Industry Canada ICES-003 Compliance

This device meets the CAN ICES-3 (A)/NMB-3(A) standards requirements.

Warning

This is a class A product. In a domestic environment this product may cause radio interference in which case the user may be required to take adequate measures.



Safety Instruction

These instructions are intended to ensure that user can use the product correctly to avoid danger or property loss.

The precaution measure is divided into “Warnings” and “Cautions”.

Warnings: Serious injury or death may occur if any of the warnings are neglected.

Cautions: Injury or equipment damage may occur if any of the cautions are neglected.

	
Warnings Follow these safeguards to prevent serious injury or death.	Cautions Follow these precautions to prevent potential injury or material damage.



Warnings

- In the use of the device, you must be in strict compliance with the electrical safety regulations of the nation and region.
- Input voltage should meet both the SELV (Safety Extra Low Voltage) and the Limited Power Source with 12 VDC according to the IEC60950-1 standard. Refer to technical specifications for detailed information.
- The output current of the power adapter must be no more than 6A.
- Do not connect multiple devices to one power adapter to avoid over-heating or a fire hazard caused by overload.
- Make sure that the plug is firmly connected to the power socket.
- Make sure that the device is firmly fixed if wall mounting or ceiling mounting is adopted.
- If smoke, odor or noise rise from the device, turn off the power at once and unplug the power cord, and then contact the service center.
- Never attempt to disassemble the camera by unprofessional personal.



Cautions

- Do not drop the camera or subject it to physical shock.
- Do not place the camera in extremely hot, cold (the operating temperature shall be -40°C to 60°C), dusty or damp locations, and do not expose it to high electromagnetic radiation.
- Do not touch sensor modules with fingers.
- If cleaning is necessary, use clean cloth with a bit of ethanol and wipe it gently.
- Do not aim the camera at the sun or extra bright places.
- The sensor may be burned out by a laser beam, so when any laser equipment is in using, make sure that the surface of sensor will not be exposed to the laser beam.
- Do not expose the device to high electromagnetic radiation or extremely hot, cold, dusty or damp environment.

- To avoid heat accumulation, good ventilation is required for the operating environment.
- Keep the camera away from liquid while in use for non-water-proof device.
- While in delivery, the camera shall be packed in its original packing, or packing of the same texture.

Mark Description

Table 0-1 Mark Description

Mark	Description
---	DC Voltage

1 Introduction

1.1 Product Features

The main features are as follows:

- High performance CMOS sensor
- IR cut filter with auto switch
- OSD menu with configurable parameters
- Auto white balance
- Internal synchronization
- SMART IR mode
- 3-axis adjustment

1.2 Overview

This manual applies to six types of cameras. The overviews of each type are shown in the figures below.

1.2.1 Overview of Type I Camera

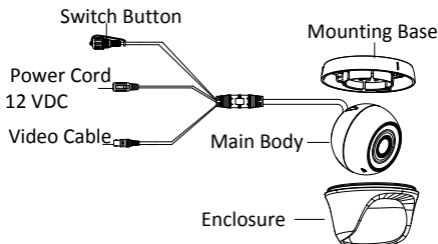

Figure 1-1 Overview of Type I Camera

Note:

Press and hold the switch button for 5 seconds to switch the video output. Four kinds of video outputs are available: TVI, AHD, CVI, and CVBS.

1.2.2 Overview of Type II Camera

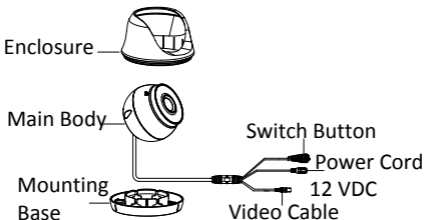

Figure 1-2 Overview of Type II Camera

Note:

Press and hold the switch button for 5 seconds to switch the video output. Four kinds of video outputs are available: TVI, AHD, CVI, and CVBS.

1.2.3 Overview of Type III Camera

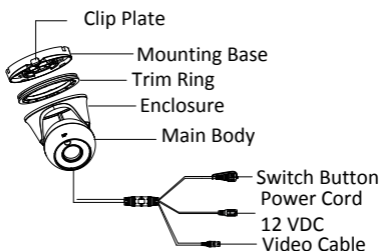

Figure 1-3 Overview of Type III Camera

Note:

Press and hold the switch button for 5 seconds to switch the video output. Four kinds of video outputs are available: TVI, AHD, CVI, and CVBS.

1.2.4 Overview of Type IV Camera

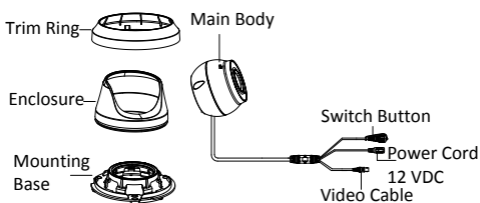

Figure 1-4 Overview of Type IV Camera

Note:

Press and hold the switch button for 5 seconds to switch the video output. Four kinds of video outputs are available: TVI, AHD, CVI, and CVBS.

1.2.5 Overview of Type V Camera

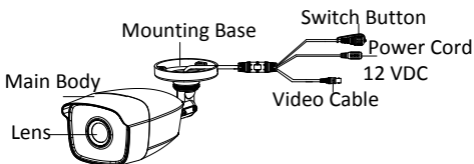

Figure 1-5 Overview of Type V Camera

Note:

Press and hold the switch button for 5 seconds to switch the video output. Four kinds of video outputs are available: TVI, AHD, CVI, and CVBS.

1.2.6 Overview of Type VI Camera

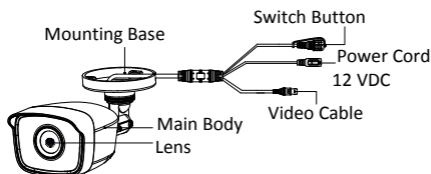

Figure 1-6 Overview of Type VI Camera

Note:

Press and hold the switch button for 5 seconds to switch the video output. Four kinds of video outputs are available: TVI, AHD, CVI, and CVBS.

2 Installation

Before you start:

- Make sure that the device in the package is in good condition and all the assembly parts are included.
- Make sure that all the related equipment is power-off during the installation.
- Check the specification of the products for the installation environment.
- Check whether the power supply is matched with your power output to avoid the damage.
- Make sure the wall is strong enough to withstand three times the weight of the camera and the mount.
- If the wall is cement, insert expansion bolts before installing the camera. If the wall is wooden, use self-tapping screws to secure the camera.
- If the product does not function properly, contact your dealer or the nearest service center. Do NOT disassemble the camera for repair or maintenance by yourself.

2.1 Installation of Type I and Type II Camera

Before you start:

Type I and type II cameras share the same installation, and we take type I camera as the example to describe the installation method.

Both wall mounting and ceiling mounting are suitable for the camera. We take ceiling mounting as an example in this section. You can take the steps of ceiling mounting as a reference, when adopting wall mounting.

Steps:

1. Disassemble the turret camera by rotating the camera to align the notch to one of the marks, as shown in the figure below.

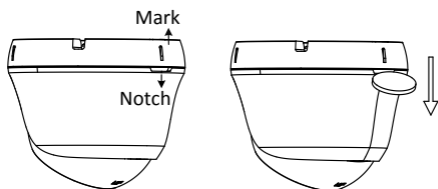

Figure 2-1 Disassemble the Camera

2. Remove the mounting base from the camera body with a flat object, e.g., a coin.
3. Paste the drill template (supplied) to the place where you want to install the camera.

4. Drill the screw holes, and the cable hole (optional) on the ceiling according to the drill template.

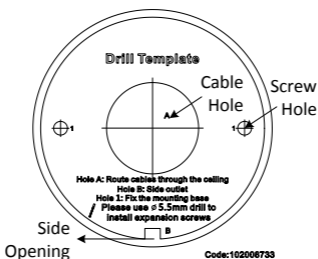

Figure 2-2 Drill Template

Note:

Drill the cable hole, when adopting the ceiling outlet to route the cable.

5. Attach the mounting base to the ceiling, and secure them with supplied screws.

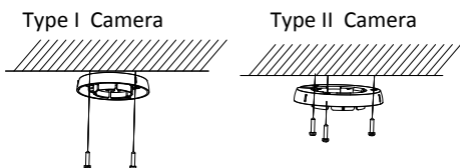

Figure 2-3 Attach the Mounting Base to the Ceiling

Note:

- The supplied screw package contains self-tapping screws, and expansion bolts.
- For cement ceiling, expansion bolts are required to fix the camera. For wooden ceiling, self-tapping screws are required.

6. Route the cables through the cable hole, or the side opening.
7. Align the camera with the mounting base, and tighten the screws to secure the camera on the mounting base.

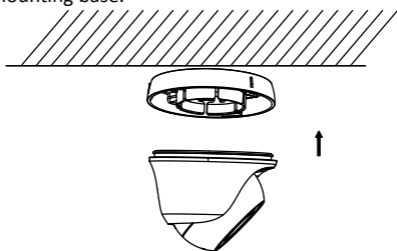

Figure 2-4 Secure the Camera with Mounting Base

8. Connect the corresponding cables, such as power cord, and video cable.
9. Power on the camera to check whether the image on the monitor is gotten from the optimum angle. If not, adjust the camera according to the figure below to get an optimum angle.

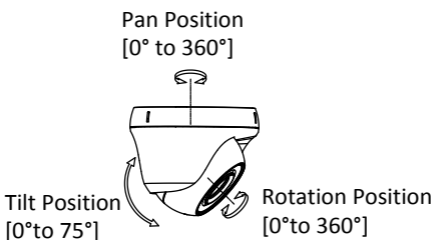

Figure 2-5 3-axis Adjustment

- 1). Hold the camera body and rotate the enclosure to adjust the pan position [0° to 360°].
- 2). Move the camera body up and down to adjust the tilt position [0° to 75°].
- 3). Rotate the camera body to adjust the rotation position [0° to 360°].

2.2 Installation of Type III Camera

Before you start:

Both wall mounting and ceiling mounting are suitable for the camera. We take ceiling mounting as an example in this section. You can take the steps of ceiling mounting as a reference, when adopting wall mounting.

Steps:

1. Disassemble the turret camera.
 - 1). Use the screw driver to loosen the screw on the mounting base.
 - 2). Align the notch to the clip plate to separate the mounting base from the camera body.

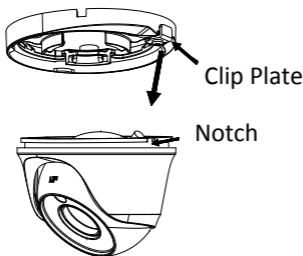

Figure 2-6 Disassemble the Camera

2. Paste the drill template (supplied) to the place where you want to install the camera.
3. Drill the screw holes and the cable hole (optional) on the ceiling according to the drill template.



Figure 2-7 Drill Template

Note:

Drill the cable hole, when adopting the ceiling outlet to route the cable.

4. Attach the mounting base to the ceiling, and secure them with supplied screws.

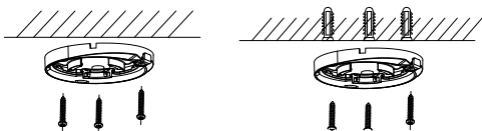

Figure 2-8 Attach the Mounting Base to the Ceiling

Note:

- The supplied screw package contains self-tapping screws, and expansion bolts.
- For cement ceiling, expansion bolts are required to fix the camera. For wooden ceiling, self-tapping screws are required.

5. Route the cables through the cable hole, or the side opening.
6. Combine the camera body with the mounting base.
 - 1). Put the camera body in the mounting base.
 - 2). Align the notch to the clip plate, and rotate the enclosure a little bit.
 - 3). Tighten the screw to secure the camera on the mounting base.

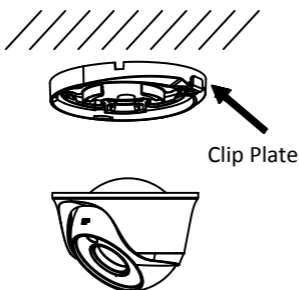

Figure 2-9 Secure the Camera with Mounting Base

7. Connect the corresponding cables, such as power cord, and video cable.
8. Power on the camera to check whether the image on the monitor is gotten from the optimum angle. If not, adjust the camera according to the figure below to get an optimum angle.

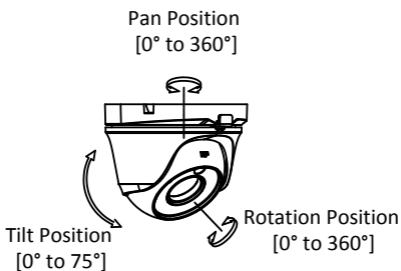

Figure 2-10 3-axis Adjustment

- 1). Rotate the enclosure to adjust the pan position [0° to 360°].
- 2). Move the camera body up and down to adjust the tilt position [0° to 75°].
- 3). Rotate the camera body to adjust the rotation position [0° to 360°].

2.3 Installation of Type IV Camera

Before you start:

Both wall mounting and ceiling mounting are suitable for the camera. We take ceiling mounting as an example in this section. You can take the steps of ceiling mounting as a reference, when adopting wall mounting.

Steps:

1. Disassemble the turret camera by rotating the trim ring anticlockwise to get the trim ring out of the camera as shown in the figure below.

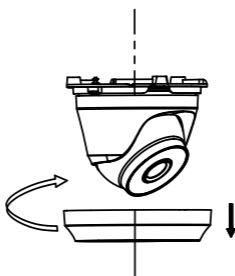

Figure 2-11 Get the Trim Ring out

2. Paste the drill template (supplied) to the place where you want to install the camera.

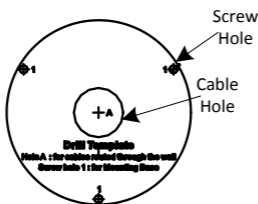

Figure 2-12 Drill Template

Note:

Drill the cable hole, when adopting the ceiling outlet to route the cable.

3. Attach the camera to the ceiling, and secure them with supplied screws.

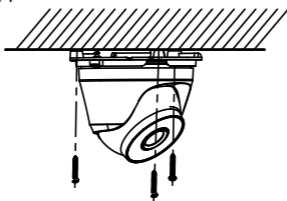

Figure 2-13 Attach the Camera to the Ceiling

Note:

- The supplied screw package contains self-tapping screws, and expansion bolts.
- For cement ceiling, expansion bolts are required to fix the camera. For wooden ceiling, self-tapping screws are required.

4. Route the cables through the cable hole, or the side opening.
5. Put the trim ring back, and tighten it by rotating it clockwise.

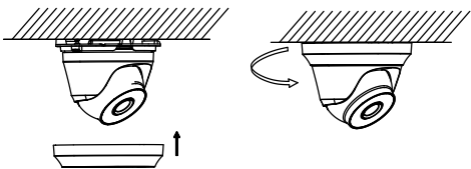

Figure 2-14 Put the Trim Ring Back and Tighten It

6. Connect the corresponding cables, such as power cord, and video cable.
7. Power on the camera to check whether the image on the monitor is gotten from the optimum angle. If not, adjust the camera according to the figure below to get an optimum angle.

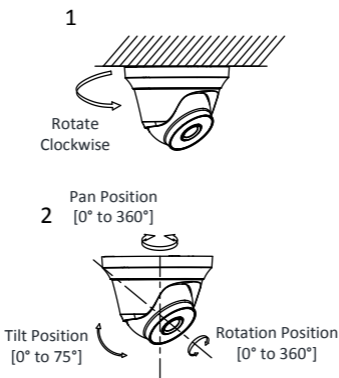

Figure 2-15 3-axis Adjustment

2.4 Installation of Type V and Type VI Camera

Before you start:

Type V and Type VI cameras share the same installation, and we take Type VI camera as the example to describe the installation method.

Both wall mounting and ceiling mounting are suitable for the camera. Ceiling mounting will be taken as an example in this section. You can take the steps of ceiling mounting as a reference, when adopting wall mounting.

Steps:

1. Paste the drill template (supplied) to the place where you want to install the camera.
2. Drill the screw holes and the cable hole (optional) in the ceiling according to the drill template.

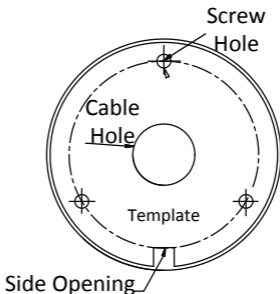

Figure 2-16 Drill Template

Note:

Drill the cable hole, when adopting the ceiling outlet to route the cable.

3. Attach the bracket to the ceiling and secure the camera with supplied screws.

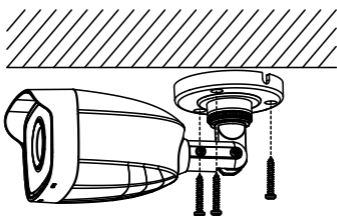

Figure 2-17 Fix the Camera to the Ceiling

Note:

- The supplied screw package contains self-tapping screws, and expansion bolts.
- For cement ceiling, expansion bolts are required to fix the camera. For wooden ceiling, self-tapping screws are required.

4. Route the cables through the cable hole, or the side opening.
5. Connect the corresponding power cord, and video cable.
6. Power on the camera to check whether the image on the monitor is gotten from the optimum angle. If not, adjust the camera according to the figure below to get an optimum angle.

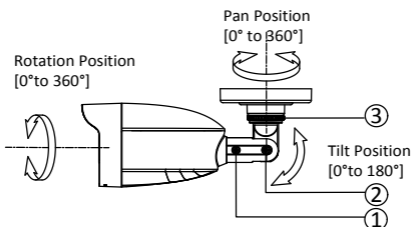



Figure 2-18 3-axis Adjustment

- 1). Loosen the No.3 screw to adjust the pan position [0° to 360°]. Tighten the screw after completing the adjustment.
- 2). Loosen the No.2 screw to adjust the tilt position [0° to 180°]. Tighten the screw after completing the adjustment.
- 3). Loosen the No.1 screw and rotate the camera [0° to 360°]. Tighten the screw after completing the adjustment.

3 Menu Description

Purpose:

Call the menu by clicking button  on the PTZ Control interface, or click **Iris+**.

Steps:

1. Connect the camera with the TVI DVR, and the monitor, shown as the figure 3-1.



Figure 3-1 Connection

2. Power on the analog camera, TVI DVR, and the monitor to view the image on the monitor.
3. Click PTZ Control to enter the PTZ Control interface.
4. Call the camera menu by clicking  button, or click **Iris+**.

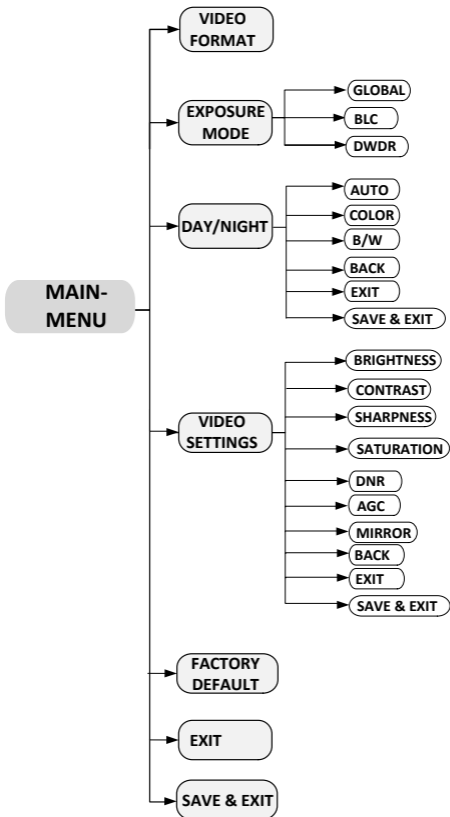

Figure 3-2 Main Menu Overview

5. Click the direction arrow to control the camera.
 - 1) Click up/down direction button to select the item.
 - 2) Click **Iris +** to confirm the selection.
 - 3) Click left/right direction button to adjust the value of the selected item.

3.1 FORMAT

For 2 MP camera, you can set the format as 2MP@30fps, or 2MP@25fps, and for 1 MP camera, 1MP@30fps, and 1MP@25ps are selectable.

3.2 EXPOSURE

Exposure describes the brightness-related parameters, which you can set the **EXPOSURE MODE** as **GLOBAL**, **BLC**, or **DWDR**.

- **GLOBAL**

GLOBAL refers to the normal exposure mode which performs exposure according to the whole image brightness.

- **BLC (Backlight Compensation)**

BLC (Backlight Compensation) compensates light for the front object to make it clear, but this may cause the over-exposure of the background, where the light is strong.

- **DWDR (Digital Wide Dynamic Range)**

DWDR helps the camera provide clear images even under backlight circumstances. When both very bright and very dark areas simultaneously exist in the image, **DWDR** balances the brightness level of the whole image to provide clear images with details.

3.3 DAY/NIGHT

COLOR, **BW** (Black White), and **AUTO** are selectable for DAY/NIGHT switch.

COLOR

The image is colored in day mode all the time.

B & W (Black and White)

The image is black and white all the time, and the **IR LIGHT** turns on in the poor light conditions.

You can turn on/off the **IR LIGHT** and set the value of **SMART IR** in this menu

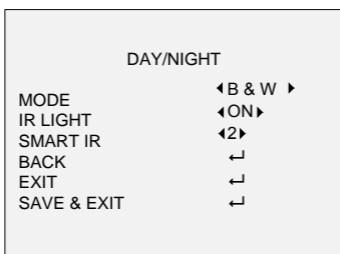

Figure 3-3 B & W

- **IR LIGHT**

You can turn on/off the **IR LIGHT** to meet the requirements of different circumstances.

- **SMART IR**

The **SMART IR** function is used to adjust the light to its most suitable intensity, and prevent the image from over exposure. The **SMART IR** value can be adjusted from 0 to 3. The higher the value is, the more obvious effects are.

AUTO

Automatically switch Color, or BW (Black and White) according to actual scene brightness.

You can turn on/off the **IR LIGHT**, and set the value of **SMART IR** in this menu.

DAY/NIGHT	
MODE	◀ AUTO ▶
IR LIGHT	◀ ON ▶
SMART IR	◀ 2 ▶
D → N THRESHOLD	◀ 2 ▶
N → D THRESHOLD	◀ 7 ▶
BACK	↵
EXIT	↵
SAVE & EXIT	↵

Figure 3-4 AUTO

- **IR LIGHT**

You can turn on/off the **IR LIGHT** to meet the requirements of different circumstances.

- **SMART IR**

The **SMART IR** function is used to adjust the light to its most suitable intensity, and prevent the image from over exposure. The **SMART IR** value can be adjusted from 0 to 3. The higher the value is, the more obvious effects are.

- **D → N Threshold (Day to Night Threshold)**

Day to Night Threshold is used to control the sensitivity of switching the day mode to the night mode. You can set the value from 1 to 9. The larger the value is, the more sensitive the camera is.

- **N → D Threshold (Night to Day Threshold)**

Night to Day Threshold is used to control the sensitivity of switching the night mode to the day mode. You can set the value from 1 to 9. The larger the value is, the more sensitive the camera is.

3.4 VIDEO SETTINGS

Move the cursor to **VIDEO SETTINGS** and click **Iris+** to enter the submenu. **BRIGHTNESS, CONTRAST, SHARPNESS, SATURATION, DNR, AGC** and **MIRROR** are adjustable.

VIDEO SETTINGS	
BRIGHTNESS	◀ 5 ▶
CONTRAST	◀ 5 ▶
SHARPNESS	◀ 5 ▶
SATURATION	◀ 5 ▶
DNR	◀ 5 ▶
AGC	◀ HIGH ▶
MIRROR	◀ OFF ▶
BACK	↵
EXIT	↵
SAVE & EXIT	↵

Figure 3-5 VIDEO SETTINGS

BRIGHTNESS

Brightness refers to the brightness of the image. You can set the brightness value from 1 to 9 to darken or brighten the image. The higher the value is, the brighter the image is.

CONTRAST

This feature enhances the difference in color and light between parts of an image. You can set the **CONTRAST** value from 1 to 9.

SHARPNESS

Sharpness determines the amount of detail an imaging system can reproduce. You can set the **SHARPNESS** value from 1 to 9.

SATURATION

Adjust this feature to change the saturation of the color. The value ranges from 1 to 9.

DNR (Digital Noise Reduction)

The DNR function can decrease the noise effect, especially when capturing moving images in poor light conditions and delivering more accurate and sharp image. You can set the **DNR** as **HIGH**, **MEDIUM**, or **LOW**.

AGC

It optimizes the clarity of the image in poor light conditions. The **AGC** level can be set as **HIGH**, **MEDIUM**, or **LOW**. Select **OFF** to disable the **AGC** function.

Note:

The noise will be amplified when the **AGC** is on.

MIRROR

OFF, **H**, **V**, and **HV** are selectable for mirror.

OFF: The mirror function is disabled.

H: The image flips 180° horizontally.

V: The image flips 180° vertically.

HV: The image flips 180° both horizontally and vertically.

3.5 FACTORY DEFAULT

Move the cursor to **FACTORY DEFAULT** and click **Iris+** to reset all the settings to the factory default.

3.6 EXIT

Move the cursor to **EXIT** and click **Iris+** to exit the menu without saving.

3.7 SAVE & EXIT

Move the cursor to **SAVE & EXIT** and click **Iris+** to save the settings, and exit the menu