



Panic Alarm Master Station

User Manual

User Manual

COPYRIGHT ©2019 Hangzhou Hikvision Digital Technology Co., Ltd.

ALL RIGHTS RESERVED.

Any and all information, including, among others, wordings, pictures, graphs are the properties of Hangzhou Hikvision Digital Technology Co., Ltd. or its subsidiaries (hereinafter referred to be “Hikvision”). This user manual (hereinafter referred to be “the Manual”) cannot be reproduced, changed, translated, or distributed, partially or wholly, by any means, without the prior written permission of Hikvision. Unless otherwise stipulated, Hikvision does not make any warranties, guarantees or representations, express or implied, regarding to the Manual.

About this Manual

This Manual is applicable to Panic Alarm Master Station.

The Manual includes instructions for using and managing the product. Pictures, charts, images and all other information hereinafter are for description and explanation only. The information contained in the Manual is subject to change, without notice, due to firmware updates or other reasons. Please find the latest version in the company website (<http://overseas.hikvision.com/en/>).

Please use this user manual under the guidance of professionals.

Trademarks Acknowledgement

HIKVISION and other Hikvision’s trademarks and logos are the properties of Hikvision in various jurisdictions. Other trademarks and logos mentioned below are the properties of their respective owners.

Legal Disclaimer

TO THE MAXIMUM EXTENT PERMITTED BY APPLICABLE LAW, THE PRODUCT DESCRIBED, WITH ITS HARDWARE, SOFTWARE AND FIRMWARE, IS PROVIDED “AS IS”, WITH ALL FAULTS AND ERRORS, AND HIKVISION MAKES NO WARRANTIES, EXPRESS OR IMPLIED, INCLUDING WITHOUT LIMITATION, MERCHANTABILITY, SATISFACTORY QUALITY, FITNESS FOR A PARTICULAR PURPOSE, AND NON-INFRINGEMENT OF THIRD PARTY. IN NO EVENT WILL HIKVISION, ITS DIRECTORS, OFFICERS, EMPLOYEES, OR AGENTS BE LIABLE TO YOU FOR ANY SPECIAL, CONSEQUENTIAL, INCIDENTAL, OR INDIRECT DAMAGES, INCLUDING, AMONG OTHERS, DAMAGES FOR LOSS OF BUSINESS PROFITS, BUSINESS INTERRUPTION, OR LOSS OF DATA OR DOCUMENTATION, IN CONNECTION WITH THE USE OF THIS PRODUCT, EVEN IF HIKVISION HAS BEEN ADVISED OF THE POSSIBILITY OF SUCH DAMAGES. REGARDING TO THE PRODUCT WITH INTERNET ACCESS, THE USE OF PRODUCT SHALL BE WHOLLY AT YOUR OWN RISKS. HIKVISION SHALL NOT TAKE ANY RESPONSIBILITIES FOR ABNORMAL OPERATION, PRIVACY LEAKAGE OR OTHER DAMAGES RESULTING FROM CYBER ATTACK, HACKER ATTACK, VIRUS INSPECTION, OR OTHER INTERNET SECURITY RISKS; HOWEVER, HIKVISION WILL PROVIDE TIMELY TECHNICAL SUPPORT IF REQUIRED.

SURVEILLANCE LAWS VARY BY JURISDICTION. PLEASE CHECK ALL RELEVANT LAWS IN YOUR JURISDICTION BEFORE USING THIS PRODUCT IN ORDER TO ENSURE THAT YOUR USE CONFORMS THE APPLICABLE LAW. HIKVISION SHALL NOT BE LIABLE IN THE EVENT THAT THIS PRODUCT IS USED WITH ILLEGITIMATE PURPOSES.

IN THE EVENT OF ANY CONFLICTS BETWEEN THIS MANUAL AND THE APPLICABLE LAW, THE LATER PREVAILS.

Regulatory Information

FCC Information

Please take attention that changes or modification not expressly approved by the party responsible for compliance could void the user's authority to operate the equipment.

FCC compliance: This equipment has been tested and found to comply with the limits for a Class B digital device, pursuant to part 15 of the FCC Rules. These limits are designed to provide reasonable protection against harmful interference in a residential installation. This equipment generates, uses and can radiate radio frequency energy and, if not installed and used in accordance with the instructions, may cause harmful interference to radio communications. However, there is no guarantee that interference will not occur in a particular installation. If this equipment does cause harmful interference to radio or television reception, which can be determined by turning the equipment off and on, the user is encouraged to try to correct the interference by one or more of the following measures:

- Reorient or relocate the receiving antenna.
- Increase the separation between the equipment and receiver.
- Connect the equipment into an outlet on a circuit different from that to which the receiver is connected.
- Consult the dealer or an experienced radio/TV technician for help.

This equipment should be installed and operated with a minimum distance 20cm between the radiator and your body.

FCC Conditions

This device complies with part 15 of the FCC Rules. Operation is subject to the following two conditions:

1. This device may not cause harmful interference.
2. This device must accept any interference received, including interference that may cause undesired operation.

EU Conformity Statement

 This product and - if applicable - the supplied accessories too are marked with "CE" and comply therefore with the applicable harmonized European standards listed under the RE Directive 2014/53/EU, the EMC Directive 2014/30/EU, the LVD Directive 2014/35/EU, the RoHS Directive 2011/65/EU.

 2012/19/EU (WEEE directive): Products marked with this symbol cannot be disposed of as unsorted municipal waste in the European Union. For proper recycling, return this product to your local supplier upon the purchase of equivalent new equipment, or dispose of it at designated collection points. For more information see: www.recyclethis.info

 2006/66/EC (battery directive): This product contains a battery that cannot be disposed of as unsorted municipal waste in the European Union. See the product documentation for specific battery information. The battery is marked with this symbol, which may include lettering to indicate cadmium (Cd), lead (Pb), or mercury (Hg). For proper recycling, return the battery to your supplier or to a designated collection point. For more information see:

www.recyclethis.info

Applicable Models



This manual is applicable to DS-PEA4H-10.

The power supply must conform to LPS. Use only power supplies listed in the user manual:

Model	Manufacturer
KPL-040F-VI	Channel Well Technology

Symbol Conventions

The symbols that may be found in this document are defined as follows.

Symbol	Description
 NOTE	Provides additional information to emphasize or supplement important points of the main text.
 WARNING	Indicates a potentially hazardous situation, which if not avoided, could result in equipment damage, data loss, performance degradation, or unexpected results.
 DANGER	Indicates a hazard with a high level of risk, which if not avoided, will result in death or serious injury.

Safety Instructions

- Proper configuration of all passwords and other security settings is the responsibility of the installer and/or end-user.
- In the use of the product, you must be in strict compliance with the electrical safety regulations of the nation and region. Please refer to technical specifications for detailed information.
- Input voltage should meet both the SELV (Safety Extra Low Voltage) and the Limited Power Source with 12 VDC according to the IEC60950-1 standard. Please refer to technical specifications for detailed information.
- Do not connect several devices to one power adapter as adapter overload may cause overheating or a fire hazard.
- Please make sure that the plug is firmly connected to the power socket.
- If smoke, odor or noise rise from the device, turn off the power at once and unplug the power cable, and then please contact the service center.

Preventive and Cautionary Tips

Before connecting and operating your device, please be advised of the following tips:

- Ensure unit is installed in a well-ventilated, dust-free environment.
- Unit is designed for indoor use only.
- Keep all liquids away from the device.
- Ensure environmental conditions meet factory specifications.
- Ensure unit is properly secured to a rack or shelf. Major shocks or jolts to the unit as a result of dropping it may cause damage to the sensitive electronics within the unit.
- Use the device in conjunction with an UPS if possible.
- Power down the unit before connecting and disconnecting accessories and peripherals.
- A factory recommended HDD should be used for this device.
- Improper use or replacement of the battery may result in hazard of explosion. Replace with the same or equivalent type only. Dispose of used batteries according to the instructions provided by the battery manufacturer.

TABLE OF CONTENTS

Chapter 1 Overview.....	1
1.1 Introduction	1
1.2 Main Feature	1
1.3 Appearance	1
1.3.1 Front Panel	1
1.3.2 Rear Panel	2
1.3.3 Side Panel	4
Chapter 2 Activation.....	6
2.1 Activating Locally.....	6
2.2 Activating via SADP Software	6
2.3 Activating via Client Software	7
Chapter 3 Local Configuration.....	9
3.1 Editing Network Parameters	9
3.2 Setting SIP Server and Master Station ID	10
3.3 Device Management	12
3.3.1 Configuring Alarm Device.....	12
3.3.2 Configuring Master Station	18
3.3.3 Configuring Network Camera.....	19
3.4 General Parameters Settings.....	20
3.4.1 Setting Sounds Parameters of Master Station	21
3.4.2 Setting Time of Master Station	22
3.4.3 Configuring Display Parameters of Master Station	24
3.5 Call Settings	25
3.5.1 Configuring Call of Master Station	26
3.5.2 Setting Alarm Video	28
3.6 System Configuration	28
3.6.1 Setting Basic System Parameters	28
3.6.2 Managing USB Flash Driver	30
3.6.3 Managing MicroSD Card	31
3.7 Project Configuration	32
3.7.1 Editing Project Password.....	32
3.7.2 configuring IO Input/Output	33
Chapter 4 Local Operation	36
4.1 Video Call	36
4.1.1 Video Call with Alarm Device	36
4.1.2 Video Call with Master Station	37
4.2 Quick Dialing	38
4.3 Broadcasting.....	39
4.3.1 Group Broadcasting.....	39
4.3.2 Temporary Broadcasting	41
4.3.3 Announcement Quick Switch Broadcasting	41
4.4 Receiving Panic Help or Consultation	42
4.4.1 Answering Call.....	42
4.4.2 Hanging up Call	44

4.4.3 Call Forwarding	44
4.4.4 Call Waiting	44
4.5 Record Query	44
4.5.1 Alarm Record Query	44
4.5.2 Call Record Query.....	45
4.6 Local Playback	47
Chapter 5 Master Station Configuration via Client Software	49
5.1 Adding Master Station to Client Software	49
5.1.1 Adding Master Station by Online Search	49
5.1.2 Adding Master Station by IP address or Domain Name.....	49
5.2 Remote Configuration via Client Software.....	50
5.2.1 Viewing Device Information.....	50
5.2.2 Configuring Time Settings	50
5.2.3 Editing General Settings	52
5.2.4 Enable SSH.....	52
5.2.5 Configuring the Password Management.....	52
5.2.6 Editing the User.....	53
5.2.7 System Maintenance.....	54
5.2.8 Editing Network Parameters	55
5.2.9 Configuring SIP Server.....	55
5.2.10 Configuring Intercom Protocol.....	56
5.2.11 Setting Video & Audio Parameters.....	57
5.2.12 Setting Video Display Parameters	58
5.2.13 Setting Intercom Audio Encoding Type.....	60
5.2.14 Managing MicroSD Card Audio File	60
5.2.15 Configuring Camera parameters	61

Chapter 1 Overview

1.1 Introduction

The DS-PEA4H-10 panic alarm master station (hereinafter called “master station”), used to manage security control devices, supports functions such as live view, intercom, device call, broadcast, etc. It is equipped with 10.1-inch HD touch screen that displays flat-design interface. The master station applies to security areas such as school, square, scenic spot, hospital, shopping mall, station, park, nursing home, etc.

1.2 Main Feature

- One-piece toughened glass panel, and multi-angle adjustable aluminum alloy bracket
- Rotatable 2 MP built-in camera, which is available for privacy protection
- Supports hands-free calls and telephone receiver calls
- Auto noise suppression and auto echo cancellation
- VGA and HDMI video output
- Supports PoE
- Video intercom between general/pole/box panic alarm devices and master station. Receives and displays alarm information
- Supports device escrow via assistant station
- Supports real-time intercom, listening, group broadcast, quick dialing, call forwarding, call waiting, etc.

1.3 Appearance

1.3.1 Front Panel

The front panel of master station is shown below.

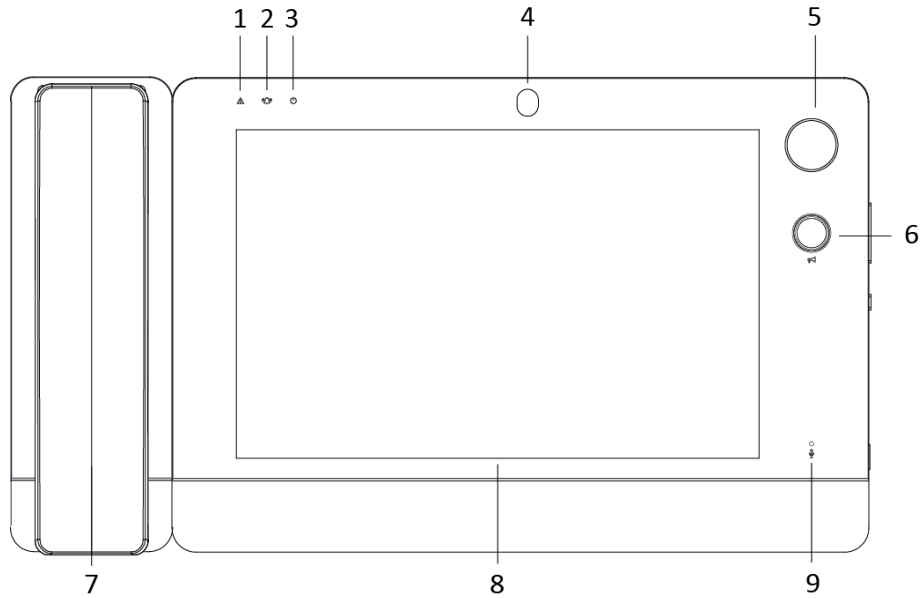

Figure 1-1 Front Panel

Table 1-1 Front Panel Component Description

No.	Component	Description
1	Exception indicator	Flashing yellow when exception occurs.
2	Information indicator	Flashing green when receiving alarm information.
3	Power indicator	Solid blue when the master station is powered on.
4	Camera	Rotatable 2 MP high definition camera.
5	Mic support interface	Connect to mic support.
6	Broadcast button	Start/End broadcast in the preset group.
7	Handset	Answer calls.
8	Screen	10.1-inch colorful TFT LCD, 1280 × 800.
9	Microphone	Audio input.

1.3.2 Rear Panel

The rear panel of master station is shown below.

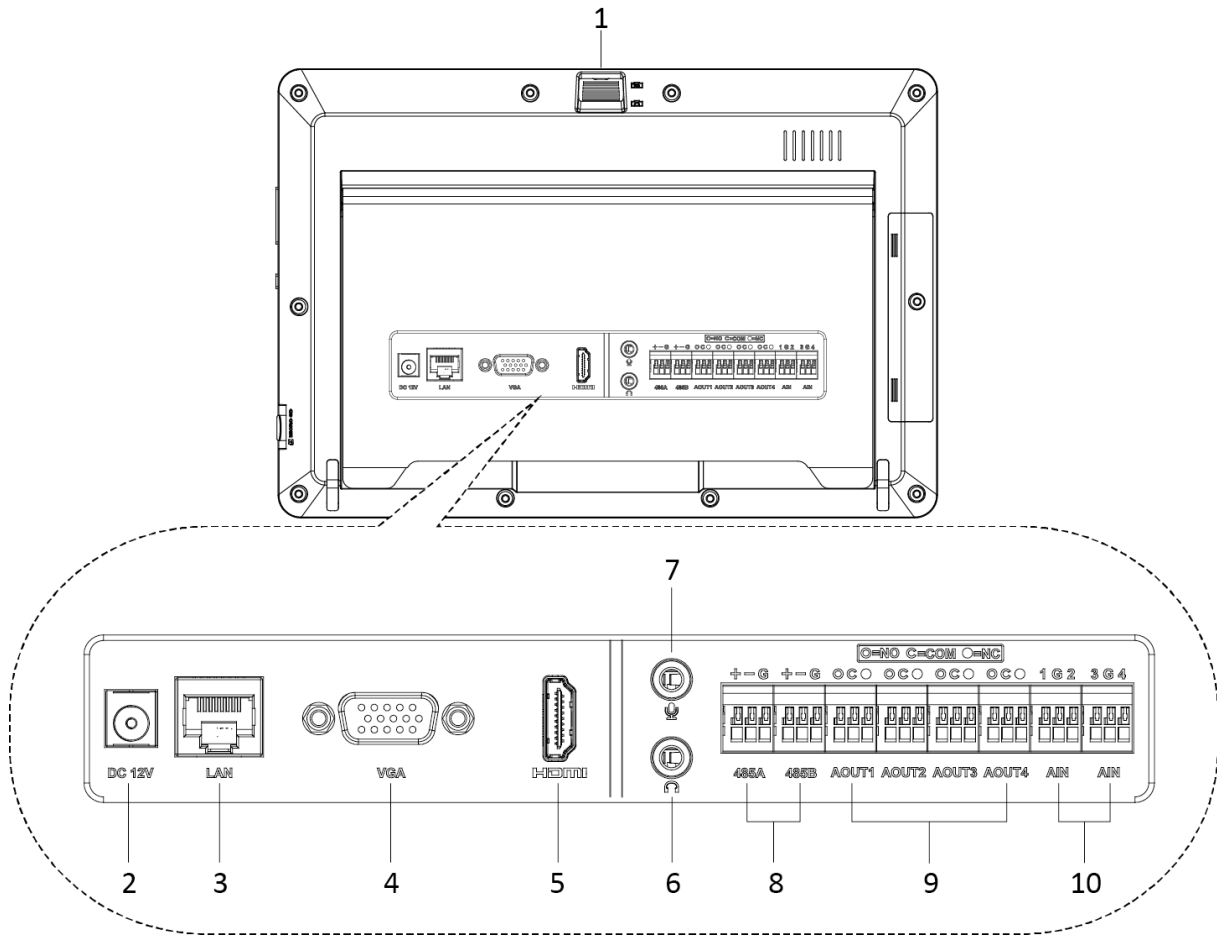

Figure 1-2 Rear Panel

Table 1-2 Rear Panel Component Description

No.	Component	Description
1	Camera angle adjustment wheel	Adjust the angle of 2MP HD camera.
2	Built-in speaker	Audio output.
3	Power interface	Connect to 12 VDC power supply.
4	Network interface	Connect to wired network.
5	VGA interface	Connect to display.
6	HDMI interface	Connect to display.
7	Audio output interface	Connect to active speaker.
8	Audio input interface	Connect to microphone.
9	RS-485 interface	Reserved.
10	Alarm output interface	Connect to alarm output devices, such as sounder, siren.
11	Alarm input interface	Connect to IO input signal, such as detectors.

1.3.3 Side Panel

The side panel of master station is shown below.

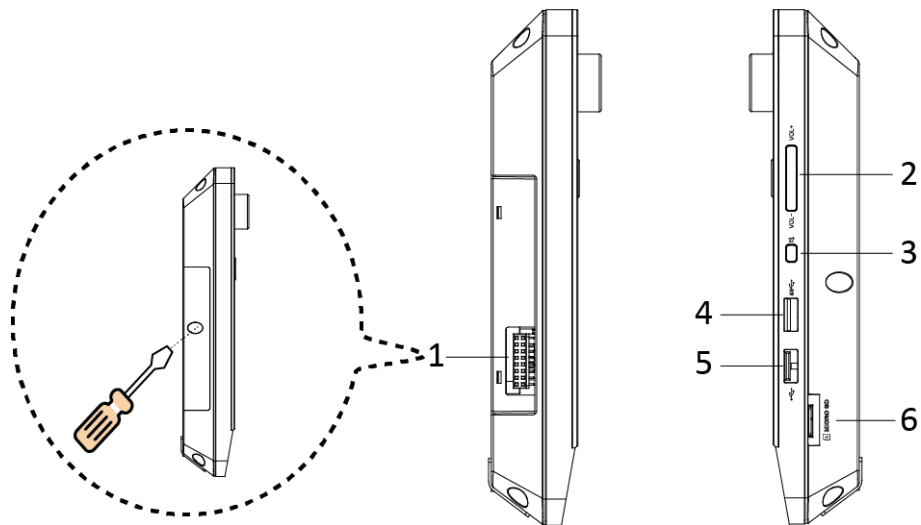

Figure 1-3 Side Panel

Table 1-3 Side Panel Component Description

No.	Component	Description
1	Handset interface	Connect to handset.
2	Volume adjustment key	Adjust speaker volume.
3	Mute key	Turn off the master station sound output.
4	USB 3.0 interface	Insert USB flash drive.
5	USB 2.0 interface	Insert USB flash drive.
6	MicroSD card interface	Insert microSD (TF) card, up to 128 GB.

Chapter 2 Activation

You should activate the master station first before you can use the master station.

Local activation, activation via SADP software, and activation via client software are supported, you can choose any one of the methods to activate the master station.

2.1 Activating Locally

Purpose:

You can activate the device locally when you access the device for the first time.

1. Power the master station on, there will be a pop-up window for device activation.

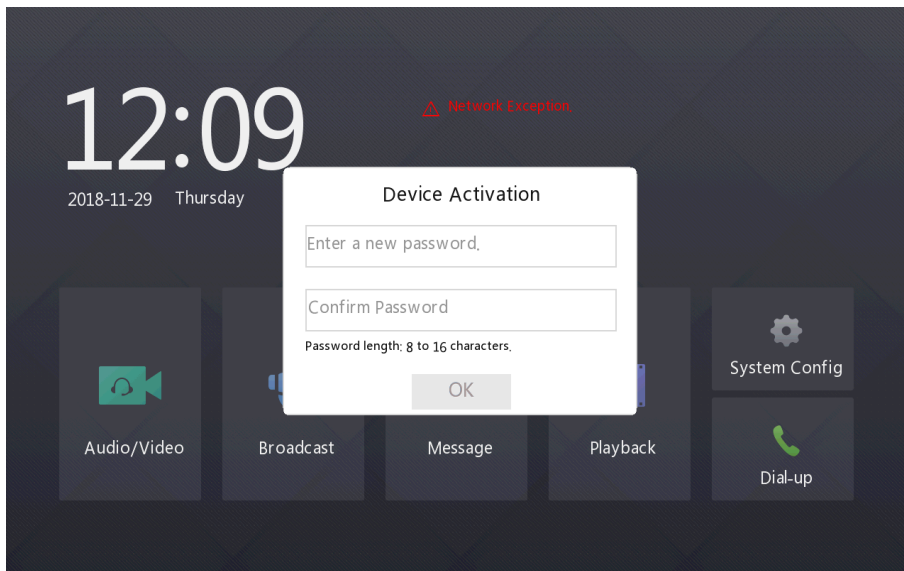

2. Create an activation password and enter the password in the password field, and confirm the password.



WARNING

STRONG PASSWORD RECOMMENDED– We highly recommend you create a strong password of your own choosing (using a minimum of 8 characters, including upper case letters, lower case letters, numbers, and special characters) in order to increase the security of your product. And we recommend you reset your password regularly, especially in the high security system, resetting the password monthly or weekly can better protect your product.

Note: Activation password can be used for adding the master station device to SADP or Client software.

3. Tap **OK** to activate the device.

2.2 Activating via SADP Software

Purpose:

SADP software is used for detecting the online device, activating the device, resetting the activation password and editing network parameters of the device.

Get the SADP software from the technical support, and install the SADP according to the prompts. Follow the steps to activate the master station.

Note: The device and the PC that runs the SADP software should be within the same subnet.

1. Run the SADP software to search the online devices.
2. Select an inactive device in the device list. And create a password and enter the password in the password field on the right, and confirm the password.



WARNING

STRONG PASSWORD RECOMMENDED— We highly recommend you create a strong password of your own choosing (using a minimum of 8 characters, including upper case letters, lower case letters, numbers, and special characters) in order to increase the security of your product. And we recommend you reset your password regularly, especially in the high security system, resetting the password monthly or weekly can better protect your product.

Note: Activation password can be used for adding the master station device to SADP or Client software.

3. Click **Activate** to activate the device.
4. **Optional:** Edit network parameters of the master station.
 - 1) Check the activated device. You can edit IP address, subnet mask and gateway of the master station manually in Modify Network Parameters list.
 - 2) Enter the password and click **Modify** to activate your IP address modification.

Note: You can either edit the network parameters of the master station locally. For detailed settings, please see *3.1 Editing Network Parameters*.

2.3 Activating via Client Software

Purpose:

The client software is versatile video management software for multiple kinds of devices. You can activate the master station via client software.

Get the client software from the technical support, and install the software according to the prompts. Follow the steps to activate the master station.

Note: The device and the PC that runs the client software should be within the same subnet.

Steps:

1. Run the client software.
2. Click **Device Management** to enter the Device Management page.
3. Check the device status from the online device list, and select an inactive device.
4. Click **Activate** to pop up the Activation window, create a password in the password field, and confirm the password.

5. Click **OK** to activate the master station.
6. **Optional:** Edit the network parameters of the master station.
 - 1) Select the master station from online device list and click **Modify Netinfor** to pop up the Network Parameter Modification page.
 - 2) Change the IP address of the master station to the same subnet with your computer by editing the IP address manually.
 - 3) Enter the password and click **OK** to save the network parameters modification.
Note: You can either edit the network parameters of the master station locally. For detailed settings, please see *3.1 Editing Network Parameters*.

Chapter 3 Local Configuration

You are able to configure the master station locally, including network parameters and SIP server parameters configuration, device management, daily configuration (sound, time and display parameters), call and alarm video configuration, system maintenance, alarm input/output and other related parameters configuration.

The master station should be activated the first time it is used to log in and use properly. For detailed activation methods, see *Chapter 2 Activation*.

3.1 Editing Network Parameters

Purpose:

After master station is activated, you should edit the network parameters of master station.

Steps:

1. On the home page of master station, tap **System Config** to enter the system configuration page.
2. Tap  and enter the project password in the pop-up window to enter the project page.

Note: The default project password is 888999. You can enter the project page to change the project password. For detailed settings, please see *3.7.1 Editing Project Password*.



WARNING

The default project password is only for the first login. To eliminate security risks, please be sure to change the project password after the first login, in order to prevent unauthorized login to your device or other adverse consequences.

3. In the project page, tap **Network** and manually edit network parameters, including IP address, gateway address and subnet mask.

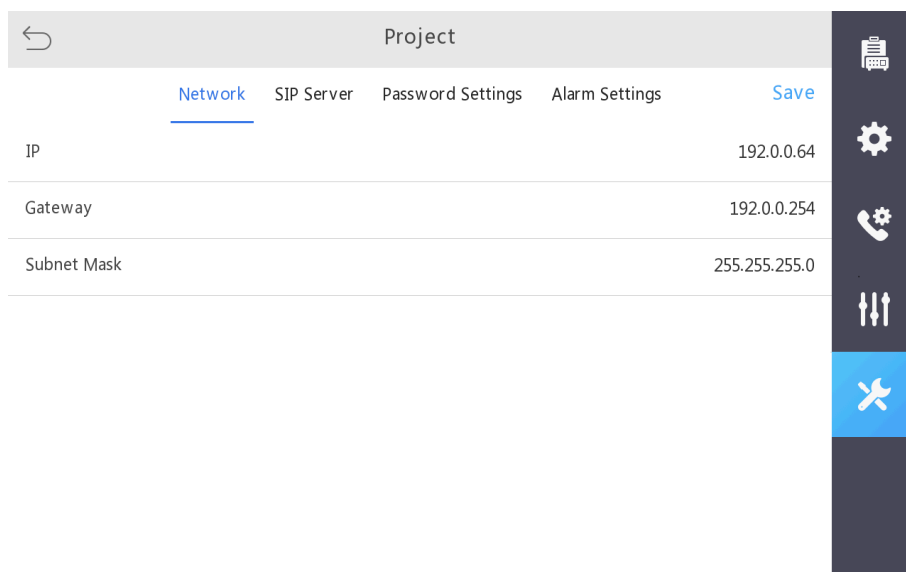

Figure 3-1 Network Parameters Configuration Page

Notes:

- The default IP address of the master station is 192.0.0.64.
- Tap the editable text on the page (e.g. 192.0.0.64) and modify the network parameters by the pop-up soft keypad. You can slide to select multiple characters on the text, or you can tap on the text content to change the text editing position.

4. Tap **Save** to save the network parameters modification.

3.2 Setting SIP Server and Master Station ID

Purpose:

To ensure normal communication between master station and the alarm device or other master station, you need to set SIP server parameters and device ID after editing network parameters.

After configuring the SIP server, the master station can communicate with the alarm device and the master stations registered to the same SIP server. After setting up the master station ID, other master stations can call the master station by entering the ID number.

Steps:

1. On the home page of master station, tap **System Config** to enter the system configuration page.
2. Tap  and enter the project password in the pop-up window to enter the project page.

Notes:

- The default project password for local project parameters configuration is 888999.
- The project password can be edited by entering **Project - Password Settings**.



WARNING

The default project password is only for the first login. To eliminate security risks, please be sure to change the project password after the first login, in order to prevent unauthorized login to your device or other adverse consequences.

3. On the project page, tap **SIP Server** to enter the page.
4. Tap > on the Protocol Type line to select the protocol type. You can select **Private Protocol** or **sip Protocol** in the pop-up window, the default protocol is **Private Protocol**.
 - When the protocol is set as **sip Protocol**, you need to set the server address type, IP address, port number, user name and password.

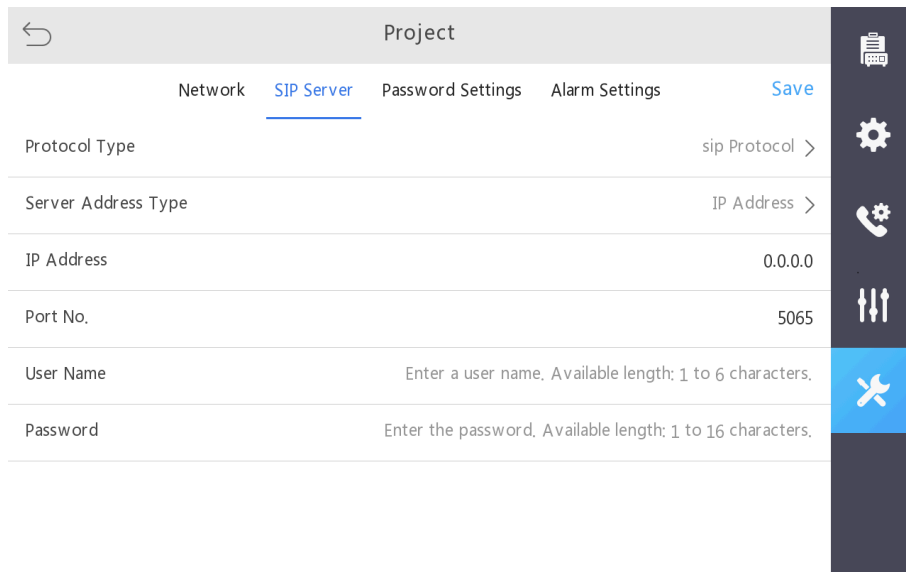

Figure 3-2 SIP Server Configuration Page (SIP Protocol)

- When the protocol is set as **Private Protocol**, you need to set the server address type, IP address, port number, device ID, device location and register period.

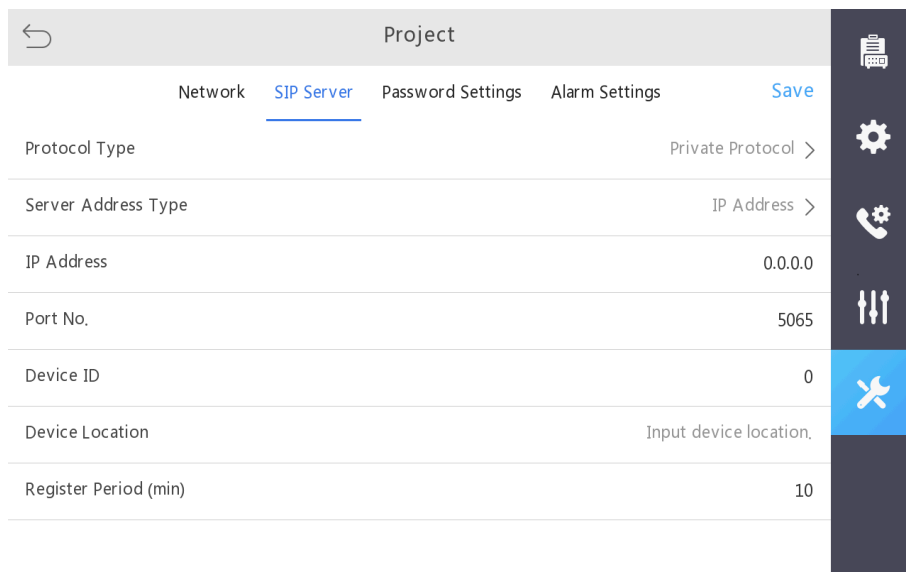

Figure 3-3 SIP Server Configuration Page (Private Protocol)

Server Address Type: Tap > on the Server Address Type line, and select **IP Address** or **Domain Name Address**. The default is **IP Address**.

IP Address: The IP address of the SIP server.

Note: The master station can double as a SIP server. The IP address of the SIP server can be either the address of a separate SIP server or the master station.

Domain Name: The domain name of the SIP server.

Port No.: By default, it is 5065. The available number should be between 1024 and 65535.

User Name: The user name which the device registers to the SIP server. The available user name should be between 0 and 999999.

Password: The user name which the device registers to the SIP server.

Device ID.: The ID number of the device, the available number should be between 0 and 999999.

Note: Device ID is the unique identification of the device, facilitating the communication between the master station and the alarm device.

Device Location: The location information of the device, the location information ranges in length from 1 to 32 characters.

Register Period (min): The interval that the device continuously registers to the SIP server, the register period ranges from 1 to 30 (min).

Note: When switching between private protocol and SIP protocol, the device must be restarted to take effect.

5. Tap **Save**.

3.3 Device Management

Purpose:

In this section, you can set up groups for alarm devices and configure them, configure the parameters of master stations, and add network camera.

3.3.1 Configuring Alarm Device

Purpose:

In this section, you are able to configure the general information of alarm devices, set up groups for alarm devices, manage groups and alarm devices, set call forwarding and hubbub alarm parameters for alarm devices.

Note: Before configuring the alarm device, you need configure the SIP server for the master station, and ensure that alarm devices and the master station register to the same SIP server.

Steps:

1. On the home page of master station, tap **System Config** to enter the page.
2. Tap  to enter the Device page.
3. Tap **Group** to enter the Group page, you are able to create groups and manage them, favorite and manage the alarm device.

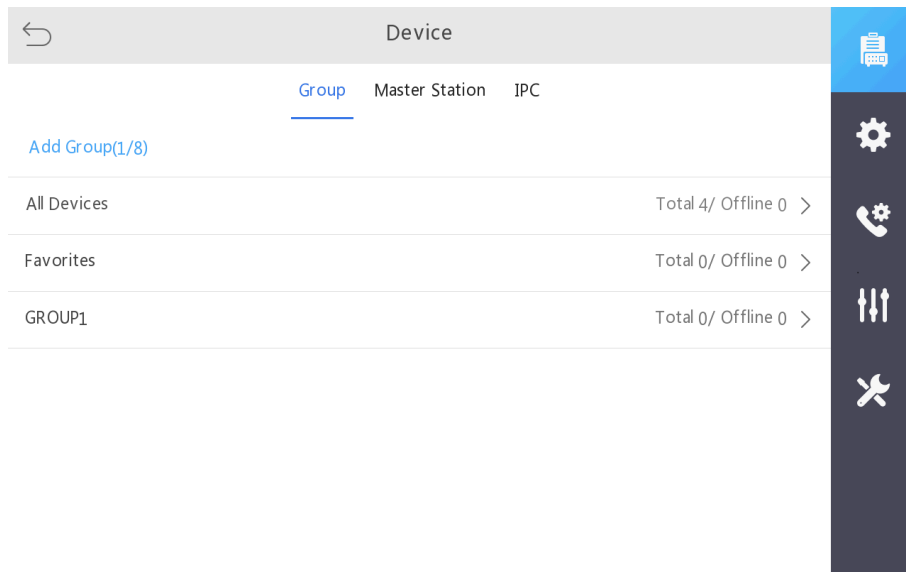

Figure 3-4 Group Page

Creating a new group

Purpose:

You are able to create a custom group for alarm devices management, up to 8 new groups can be set up.

Steps:

1. On the Group page, tap **Add Group** to enter the group name in the pop-up dialog box, and tap **OK**.

Note: By default, the master station has 2 groups: **All Devices**, **Favorites**.

2. Add alarm devices to Group.

1) On the Group page, tap a new group to enter the page.

2) Tap **Add Devices** to enter the page.

	ID	Name	IP	Position
<input type="radio"/>	201102	Box Station	10.22.100.201	ppp
<input type="radio"/>	111	Cascade Panic	10.22.98.111	111
<input type="radio"/>	198	Pinhole Panic	10.22.100.198	FS198
<input type="radio"/>	133	Pinhole Panic	10.22.98.133	133

Figure 3-5

3) Select and check alarm devices in the list, you are able to select the devices in batch.

You can tap  on the upper right corner and enter the information (ID number, name, IP address and location) of the alarm devices to search the alarm devices. Fuzzy search is supported.

4) Tap **OK**.

Group Management

Purpose:

You are able to manage the group, including add alarm devices, Delete alarm devices, rename and delete groups.

● Adding alarm devices to group

Steps:

1. On the Group page, tap a group, and tap **+** on the upper right corner of the page.
2. Select and check alarm devices in the list, you are able to select the devices in batch.

You can tap  on the upper right corner and enter the information (ID number, name, IP address and location) of the alarm devices to search the alarm devices. Fuzzy search is supported.

3. Tap **OK**.

● Deleting alarm devices from a group

Steps:

1. On the Group page, tap a group, and long press on the alarm device.
2. Select **Delete** or **Delete in Batch** in the pop-up window.

Delete: Delete the selected alarm device.

Delete in Batch: Tap **Delete** in Batch, you are able to check device alarms in batch in the list and delete all selected devices.

3. Tap **OK** to delete alarm devices, or tap **Cancel** to cancel the operation.

● Renaming a group

Steps:

1. On the Group page, long press on the group.
2. Select **Rename** in the pop-up window, and enter the new group name in the textbox.
3. Tap **OK** to rename the group, or tap **Cancel** to cancel the operation.

● Deleting a group

Steps:

1. On the Group page, long press on the group.
2. Select **Delete Group** in the pop-up window.
3. Tap **OK** to delete the group, or tap **Cancel** to cancel the operation.

Collecting Alarm Devices

Purpose:

You are able to add focus alarm devices to favorites group, it is convenient to view the alarm device and communicate with the alarm device in the favorites group.

Steps:

1. On the Group page, tap **All Devices** to enter the page.
2. Select an alarm device in the device list, and tap asterisk. If the asterisk is blue, the alarm device is collected, otherwise, the alarm device is not collected.

Note: Devices that have been collected are displayed in the device list of the favorites group.

Deleting All Disconnected Alarm Devices

Purpose:

You are able to empty offline alarm devices for easy management.

Steps:

1. On the Group page, tap **All Devices** to enter the page.
2. Long press any one of disconnected alarm devices, and tap **Delete All Disconnected Devices**.
3. Tap **OK** to delete all disconnected alarm devices, or tap **Cancel** to cancel the operation.

Note: After restarting, the deleted disconnected alarm devices do not appear in the device list.

Editing General Information of Alarm Device

Note: The general information only can be edited if the master station is the main master station (that is, the master station double as a SIP server).

Steps:

1. On the Group page, tap **All Devices** to enter the page.
2. Select and tap an alarm device to enter the alarm device configuration page.
3. Tap **General Information**, you are able to edit the name and location of the alarm device.
4. Tap **OK**.

Setting Call Forwarding of Alarm Device

Purpose:

In this section, you can enable the call forwarding for alarm device. IF the call forwarding of the alarm device is enabled, the SIP server will transfer the call to the first priority master station when receive a call from this alarm device. If the first priority master station dose not answer the call, for example, it is on the line or offline, the take time exceeds the call waiting time, call forwarding by manual, or master station call list is full, the SIP server will transfer the call to the next priority master station.

Notes:

- You can only set the call forwarding for the alarm device on main master station.
- If you do not configure the master station call priority of the alarm device, the default setting is call waiting.

Steps:

1. On the Group page, tap **All Devices** to enter the page.
2. Select and tap an alarm device to enter the alarm device configuration page.
3. Tap **Call Settings**, slide the slider to enable Call Forwarding.

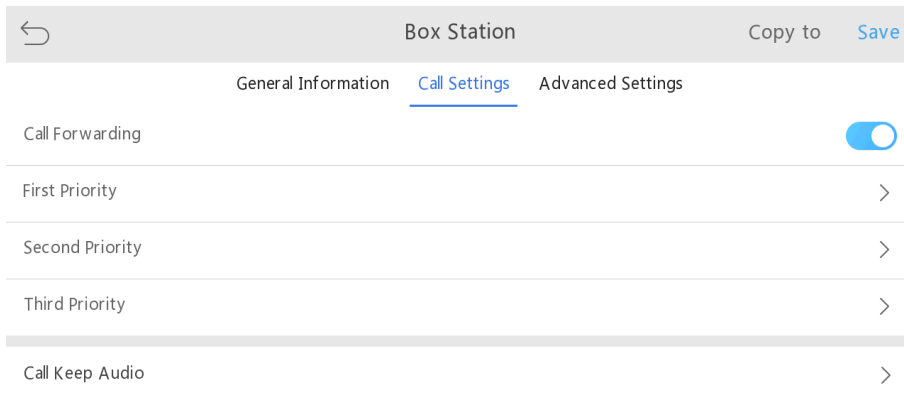

Figure 3-6 Call Forwarding Page

Note: The call forwarding function is not enabled by default. If you do not enable the call forwarding function, you need to configure the main master station for the alarm device. Tap > on the Main Master Station line to enter the page, and then tap > on the Master Station line to select a master station as the main master station.

4. Set the call forwarding priority.
 - 1) Tap > on the First Priority line to enter the page.
 - 2) Tap > on the Master Station line, select a master station as the first priority master station and tap **OK**.
 - 3) Enter the transfer wait time, by default, it is 10, the available value is between 5 and 15.
 - 4) Tap **OK** to save the settings.
 - 5) Follow 1) - 2) to set the second and third priority master station and transfer wait time.
5. **Optional:** Tap **Copy to** to copy the call settings to other alarm devices.
6. Tap **OK**.

Setting Call Waiting Audio of Alarm Device

Purpose:

When the alarm device is calling with the master station, if you tap the call waiting button on the master station, the call with the alarm device will enter the call waiting state. At this time, the alarm device will play the configured call waiting audio file until the end of the call waiting state.

Steps:

1. On the Group page, click **All Devices** to enter the page.
2. Select and click an alarm device to enter the alarm device configuration page.
3. Tap **Call Settings**, and click **Call Keep Audio** to select an audio file in the pop-up window. You are able to select the audio file from local file list or SD card file list as the call waiting audio.

Note: The local audio file comes with the device. The SD card audio file requires to be uploaded, and you need to insert the SD card into the microSD card interface for using the SD card audio file.

4. **Optional:** Tap **Copy to** to copy the call waiting audio to other alarm devices.
5. Tap **OK**.

Configuring Call Forwarding of Alarm Device

Purpose:

In this section, you are able to configure the hubbub alarm parameters for the alarm devices.

Steps:

1. On the Group page, click **All Devices** to enter the page.
2. Select and click an alarm device to enter the alarm device configuration page.
3. Tap **Advanced Settings** to enter the page.

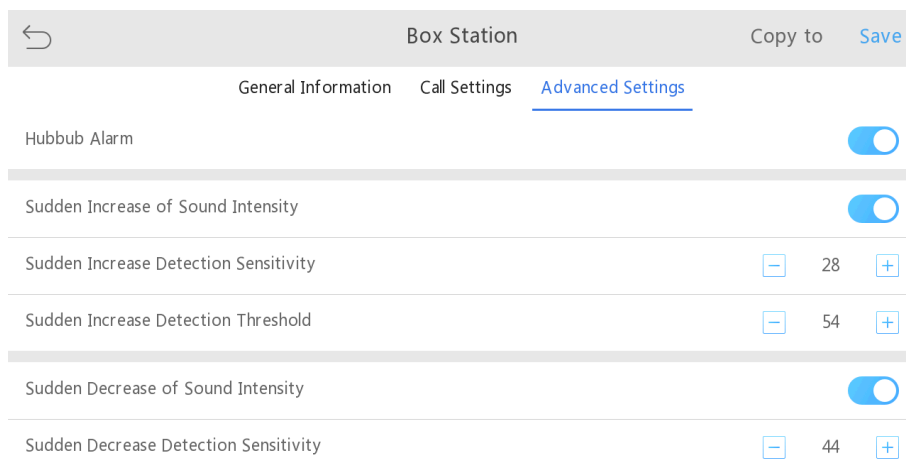

Figure 3-7 Hubbub Alarm parameters configuration

Hubbub Alarm: Slide the slider to enable Hubbub Alarm, by default, it is disenabled.

Sudden Increase of Sound Intensity: Slide the slider to enable Sudden Increase of Sound Intensity, by default, it is disenabled. You need to set sudden increase parameters, including detection sensitivity and threshold. The available sensitivity value and threshold is between 1 and 100.

Sudden Decrease of Sound Intensity: Slide the slider to enable Sudden Decrease of Sound Intensity, by default, it is disabled. You need to set sudden decrease sensitivity, the available sensitivity value is between 1 and 100.

4. **Optional:** Tap **Copy to** to copy the hubbub alarm parameters to other alarm devices.
5. Tap **OK**.

3.3.2 Configuring Master Station

Purpose:

In this section, you are able to configure the general information and the call waiting audio of master station.

Steps:

1. On the home page of master station, click **System Config** to enter the page.
2. Tap  to enter the Device page.
3. Tap **Master Station** and click a master station in the list to enter the master station configuration page.

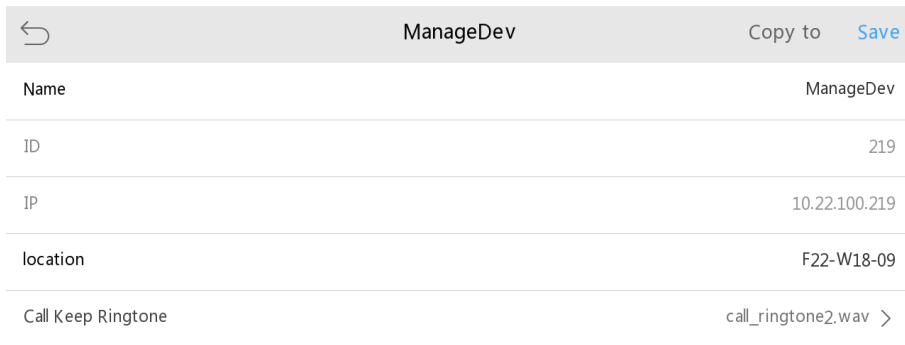

The screenshot shows a mobile application interface for configuring a master station. At the top, there is a navigation bar with a back arrow on the left, the title 'ManageDev' in the center, and 'Copy to' and 'Save' on the right. Below the navigation bar is a table with configuration details. The table has two columns: the left column lists the configuration items, and the right column shows their current values. The items are Name, ID, IP, location, and Call Keep Ringtone.

	ManageDev	Copy to	Save
Name			ManageDev
ID			219
IP			10.22.100.219
location			F22-W18-09
Call Keep Ringtone			call_ringtone2.wav >

Figure 3-8 Master Station Configuration Page

Editing General Information of Master Station

In master station configuration page, the main master station can edit name and location of all master stations, and the slave master station (which does not double as a SIP server) cannot edit the general information of other master station.

Note: The master station doubles as a SIP server is the main master station, the other master stations are the slave master stations.

Setting Call Waiting Audio of Master Station

Purpose:

When there are two master stations have an intercom with each other, if one of the master station clicks the call waiting button, the other side master station will enter the call waiting state, and play the configured call waiting audio file until the end of the call waiting state.

Steps:

1. On the master station configuration page, click **Call Keep Audio** to select an audio file in the pop-up window. You are able to select the audio file from local file list or SD card file list as the call waiting audio.

Note: The local audio file comes with the device. The SD card audio file requires to be uploaded, and you need to insert the SD card into the microSD card interface for using the SD card audio file.

2. **Optional:** Tap **Copy to** to copy the call waiting audio to other master station.
3. Tap **OK**.

3.3.3 Configuring Network Camera

Purpose:

In this section, you are able to add, edit or delete network cameras. The network camera can be used together with the alarm device to facilitate video view of the surrounding environment of the alarm device.

Steps:

1. On the home page of master station, click **System Config** to enter the page.
2. Tap  to enter the Device page.
3. Tap **IPC** to enter the IPC page.

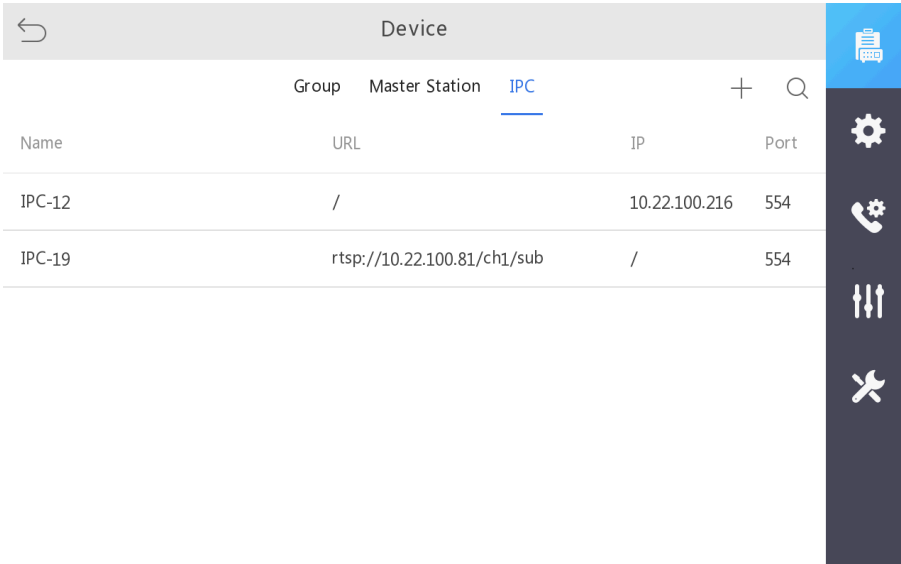

Name	URL	IP	Port
IPC-12	/	10.22.100.216	554
IPC-19	rtsp://10.22.100.81/ch1/sub	/	554

Figure 3-9 IPC Configuration Page

Adding a Network Camera

Purpose:

On the IPC page, you are able to add network camera.

Steps:

1. Tap **Add Devices** or **+** to pop up the Add Devices window.

2. Select **IP Address** or **URL** to add network cameras.

– Adding a network camera by **IP Address**.

Select **IP Address**, enter the name, IP address, port number, user name and password of the network camera, and click **OK** to add the network camera. The default port number is 554.

– Adding a network camera by **URL**.

Select **URL**, enter the name, URL, port number, user name and password of the network camera, and click **OK** to add the network camera. The default port number is 554.

Editing Network Camera Information

Purpose:

On the IPC page, you are able to edit the information of network cameras.

Steps:

1. On the IPC page, search the network camera in the list.

You can click  on the upper right corner and enter the information (ID number, name, IP address and location) of the network camera to search the network camera. Fuzzy search is supported.

2. Tap the network camera and edit the name, IP address/URL, port number, user name and password of the network camera.

3. Tap **OK**.

Deleting Network Camera

Purpose:

On the IPC page, you are able to delete network cameras.

Steps:

1. On the IPC page, search the network camera in the list.

You can click  on the upper right corner and enter the information (ID number, name, IP address and location) of the network camera to search the network camera. Fuzzy search is supported.

2. Long press the network camera to pop up the window, you are able to click **Delete** to delete the selected network camera, or click **Cancel** to cancel the operation.

3. Tap **OK**.

3.4 General Parameters Settings

Purpose:

In this section, you can configure the sounds, time and display parameters for the master station.

3.4.1 Setting Sounds Parameters of Master Station

Purpose:

In this section, you are able to set the call ringtone, ring duration, audio input/output and its corresponding volume and keypad sound.

Steps:

1. On the home page of master station, click **System Config** to enter the page.
2. Tap  to enter the General page.
3. Tap **Sounds** to enter the sound configuration page.

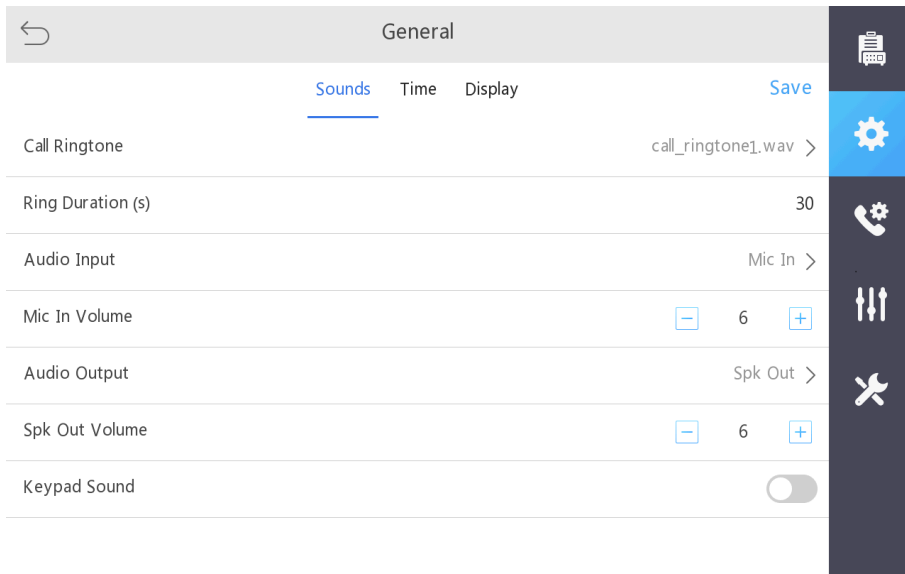

Figure 3-10 Sounds Configuration Page

Call Ringtone: Tap **Call Ringtone** to select an audio file in the pop-up window. You are able to select the audio file from local file list or SD card file list as the call ringtone. The default call ringtone is call_ringtone1.

Note: The local audio file comes with the device. The SD card audio file requires to be uploaded, and you need to insert the SD card into the microSD card interface for using the SD card audio file.

Ring Duration (s): Enter the ring duration for the incoming call. By default, it is 30, the available value is 30 to 60.

Note: The ring duration is only applied to the master station call master station, and the called master station determines the ring duration.

Audio Input: Tap **Audio Input** to select an audio input in the pop-up window. You are able to select **Mic In** (comes with the device), **Line In1** (3.5 mm input) and **Line In2** (the mic support) as the audio input to be configured.

Mic In Volume/Line In1 Volume/Line In2 Volume: Set the volume of the selected audio input.

Audio Output: Tap **Audio Output** to select an audio output in the pop-up window. You are able to select **Spk Out** (comes with the device), **Line Out** (3.5 mm output) and **Spk Out & Line Out** as the audio output to be configured.

Speak Out Volume: Set the volume of Speaker output.

Line Out Volume: Set the volume of Line Out audio output.

Notes:

- By default, the volume of all audio inputs and audio outputs is level 6, the level ranges from 0 to 10.
- When you select the audio output as **Spk Out & Line Out**, you are able to set the volume of the two outputs separately.

Keypad Volume: By default, the keypad volume is off, you are able to slide the slider to enable the keypad volume.

3.4.2 Setting Time of Master Station

Purpose:

In this section, you are able to set the time display mode of the home page, configure the NTP parameters and the DST parameters.

Steps:

1. On the home page of master station, click **System Config** to enter the page.
2. Tap  to enter the General page.
3. Tap **Time** to enter the time configuration page.

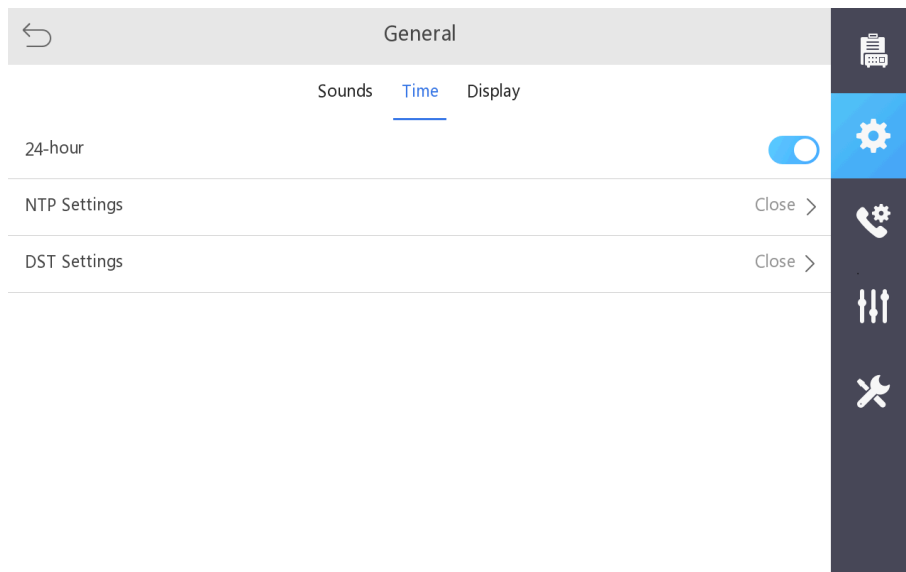

Figure 3-11 Time Configuration Page

Editing the Time Display Mode

You are able to set the time display mode as 24-hour or 12-hour. By default, it is 24-hour.

If the slider is blue, the time display mode on the home page is 24-hour, otherwise, the time display on the home page is 12-hour.

Enabling NTP

Purpose:

In this section, you are able to enable the NTP and configure the NTP parameters. After enabling NTP, the device synchronizes the time periodically from the NTP server based on the interval automatically. By default, the NTP function is close.

Steps:

1. Tap > on the NTP Settings line to enter the NTP page.

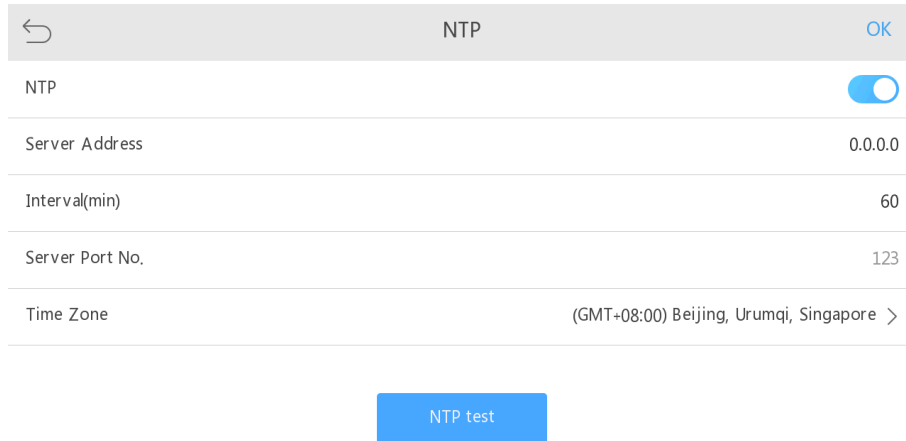

Figure 3-12 NTP Page

2. Slide the slider to enable NTP, and enter the IP address or domain name of the NTP server, set the interval, server port number, time zone.

Server Address: The IP address or domain name of the NTP server. By default, it is 0.0.0.0. The domain name ranges in length from 0 to 64 characters.

Interval (min): By default, it is 60. The available value is between 1 and 10080.

Server Port No.: By default, it is 123. Does not support modification.

3. Tap **NTP test** to test whether the connection is successful to the NTP server.
4. Tap **OK**. The NTP settings status updates from **Close** to **Open**.

Enabling DST

Purpose:

In this section, you are able to enable the DST (Daylight Saving Time) and configure the DST parameters.

Steps:

1. Tap > on the DST Settings line to enter the DST Settings page.

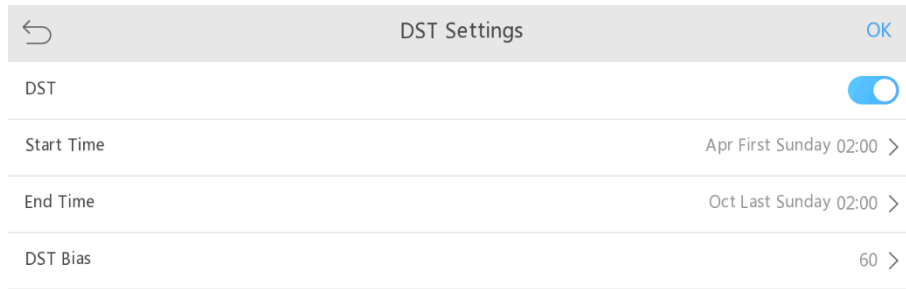

Figure 3-13 DST Settings Page

- Slide the slider to enable DST, and select the start time, the end time and the DTS bias of the DST.

Start Time: Tap > in the Start Time line to pop up the Time Settings window, and configure the start time of DST.

End Time: Tap > in the End Time line to pop up the Time Settings window, and configure the end time of DST.

DST Bias: By default, it is 60. You can click > in the DST Bias line to select the DST bias in pop-up window.

- Tap **OK**. The DST settings status updates from **Close** to **Open**.

3.4.3 Configuring Display Parameters of Master Station

Purpose:

In this section, you are able to set the display parameters for the master station, including HDMI & VGA, camera test and screen brightness.

Steps:

- On the home page of master station, click **System Config** to enter the page.
- Tap  to enter the General page.
- Tap **Display** to enter the display configuration page.

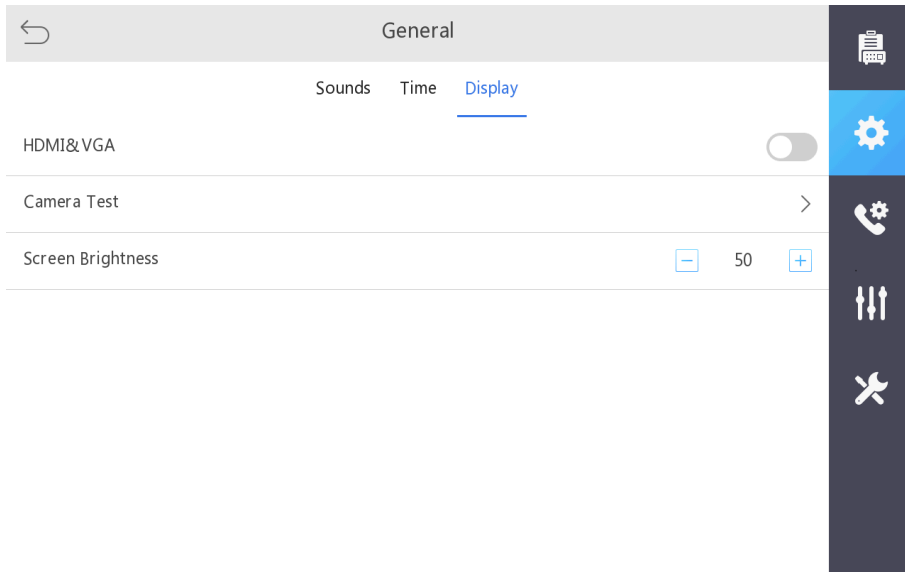

Figure 3-14 Display Configuration Page

Enabling HDMI & VGA

Purpose:

The master station can connect to external display of local video via HDMI or VGA interface, external display needs to be enabled manually.

Enter the display configuration page, slide the slider in the HDMI & VGA line to enable the external display function. By default, this function is off.

When connected to the external display via the HDMI or VGA interface, the external display displays the previewing video and receiving alarm video.

Camera Test

The master station supports camera test function.

Enter the display configuration page, click > in the Camera Test line, the interface will display the live view collected by the camera, and you are able to observe the live view for camera test.

Adjusting Screen Brightness

Purpose:

In this section, you can adjust the screen brightness on the display configuration page.

Enter the display configuration page, click “+” or “-” in the Camera Test line to adjust the screen brightness value. The screen brightness will change in real time with the brightness value. The higher the brightness value, the brighter the device. The brightness value defaults to 50.

3.5 Call Settings

Purpose:

In this section, you are able to configure the call and alarm video for the master station.

3.5.1 Configuring Call of Master Station

Purpose:

In this section, you are able to configure the announcement quick switch, auto answering, assistant management.

Steps:

1. On the home page of master station, click **System Config** to enter the page.
2. Tap  to enter the Call page.
3. Tap **Call Settings** to enter the call configuration page.

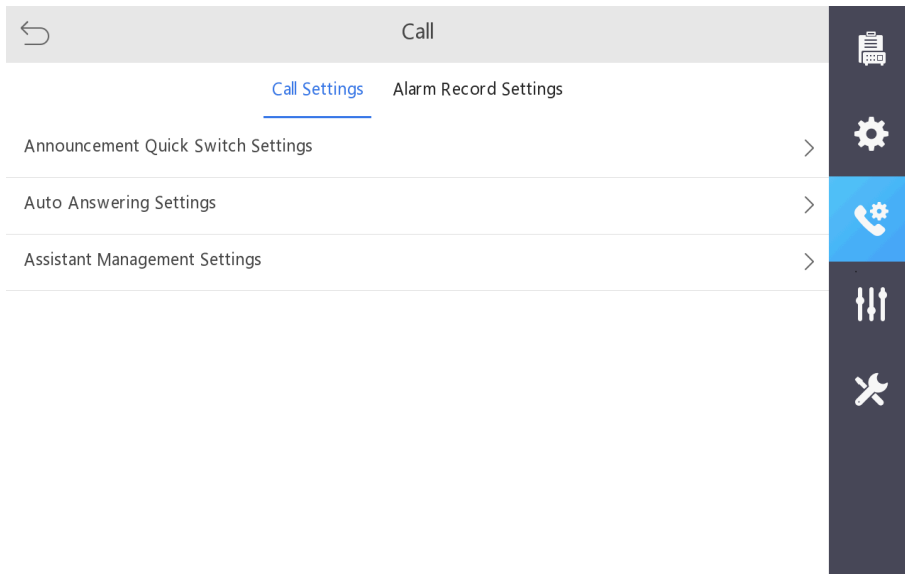

Figure 3-15 Call Configuration Page

Configuring Announcement Quick Switch

Purpose:

The master station supports the announcement quick switch function. After configuring the groups for announcement quick switch, you can click the broadcast button (on the right side of the front panel of the master station) to broadcast all the alarm devices in the group. The announcement quick switch function needs to be used when the master station is not calling.

Steps:

1. On the call configuration page, click > in the Announcement Quick Switch line to enter the page.
2. Check a group in the list.
3. Tap **OK** to save the settings.

Note: By default, the master station announces to all alarm devices. If you want to announce to the specific groups, you need to enter **System Config** -  - **Group** to add groups for announcement quick switch.

Configuring Auto Answering

Purpose:

You are able to enable auto answering function for the master station. If auto answering is enabled, after receiving the alarm device or the master station call, the master station will automatically answer the call when the configured auto answering duration arrives.

Steps:

1. On the call configuration page, click > in the Auto Answering Settings line to enter the page.
2. Slide the slider to enable the auto answering.

Note: The automatic answering can also be turned off through the slider, click **OK** to save the settings and the auto answering of the master station will be cancelled. When the master station or the alarm device calls the master station, the master station needs to answer the call manually.

3. Enter the auto answering duration. By default, it is 5, the available value is between 0 and 30.
4. Tap **OK** to save the settings.

Notes:

- If there are more than one call, the master station only automatically answers the first one.
- The master station does not automatically answer when is in a state of listening, announcing, broadcasting, etc., and only the call received in the state where the master station does not have any call will automatically answer the call.

Configuring Assistant Management

Purpose:

You are able to enable assistant management function for the master station. If the current master station is idle (unattended), you can enable assistant management, and all calls received in the assistant management state will be transferred to the assisted master station.

Steps:

1. On the call configuration page, click > in the Assistant Management Settings line to enter the page.
2. Slide the slider to enable the auto answering.

Note: The assistant management can also be turned off through the slider, click **OK** to save the settings and cancel the assistant management state. The call can be answered normally after exiting the managed state.

3. Tap > in the Master Station line to enter the page, and select a master station in the list as the assisted master station, click **OK**.
4. Tap **OK** to save the settings.

Notes:

- The assisted master station should not enable the assistant management, and the master station has been enabled the assistant management cannot be selected as the assisted master station.
- The master station will not automatically exit the assistant management state after restarting.

3.5.2 Setting Alarm Video

Purpose:

In this section, you are able to enable alarm video record, including the panic alarm record, consultation record, hubbub alarm record, and master station calling record.

Steps:

1. On the home page of master station, click **System Config** to enter the page.
2. Tap  to enter the Call page.
3. Tap **Alarm Record Settings** to enter the alarm record settings page.

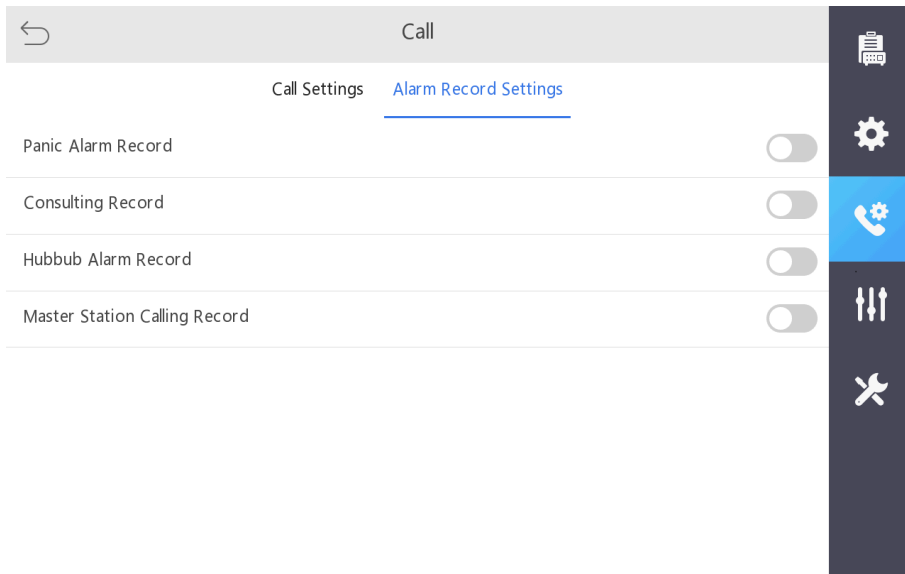

Figure 3-16 Alarm Record Settings Page

4. On the alarm record settings page, you can slide the slider to enable the video record function of the corresponding alarm event. When the alarm event occurs and the record is enabled, the video will be stored automatically.

3.6 System Configuration

Purpose:

In this section, you are able to configure the basic settings, and manage the USB flash drive and microSD card.

3.6.1 Setting Basic System Parameters

Purpose:

In this section, you are able to view the device type and version, enable the screen clean mode, reboot the master station and restore defaults.

Steps:

1. On the home page of master station, click **System Config** to enter the page.

2. Tap  to enter the System Maintenance page.
3. Tap **Basic Settings** to enter the basic settings page.

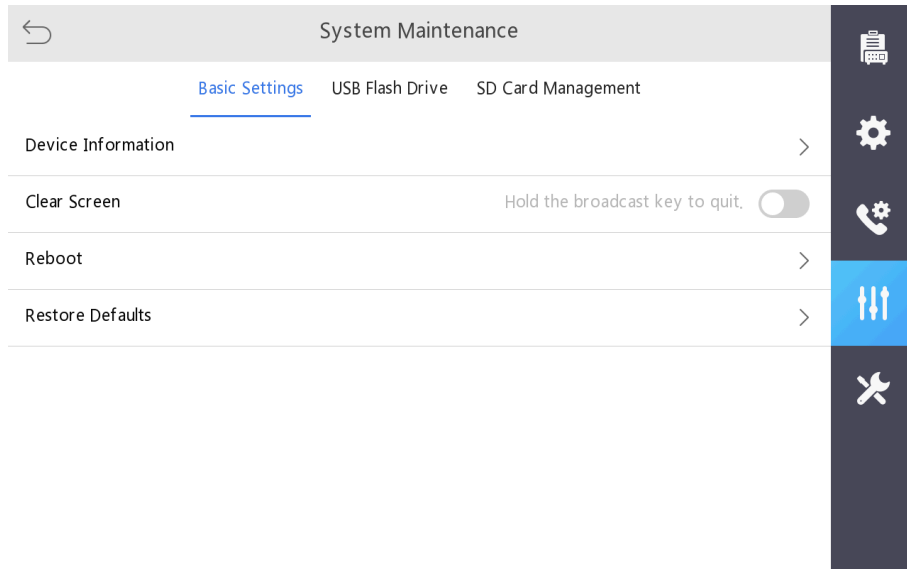

Figure 3-17 Basic Settings Page

Viewing Device Information

Enter the basic settings page, click > in the Device Information line, you can view the device type and version in the pop-up window.

Cleaning the screen

Purpose:

You are able to enable this function for screen clean. If you enable this function, the master station won't do nothing when you touch the screen, and you can use the cleaning tool to clean the screen.

Steps:

1. On the Basic Settings page, slide the slider to enable **Clear Screen**.
2. Cleaning the screen.
3. Long press the broadcast button to exit the clear screen mode.

Rebooting Master Station

Purpose:

You are able to reboot the master station locally.

On the Basic Settings page, click > in the Reboot line to pop up the Reboot Device window. You can click **OK** to reboot the master station, or click **Cancel** to cancel the operation.

Restoring Defaults

Purpose:

In this section, you can restore the all device parameters except network parameters to defaults.

On the Basic Settings page, click > in the Restore Defaults line to pop up the Reboot Device window. You can click **OK** to reboot the master station, or click **Cancel** to cancel the operation.

Note: The device will reboot automatically after restoring defaults.

3.6.2 Managing USB Flash Driver

Purpose:

In this section, you are able to import/export configuration files or upgrade devices via USB flash driver.

Before managing the USB flash driver, you need to insert the USB flash driver into device, the available system format is FAT32.

Steps:

1. On the home page of master station, click **System Config** to enter the page.
2. Tap  to enter the System Maintenance page.
3. Tap **USB Flash Driver** to enter the USB flash driver management page.

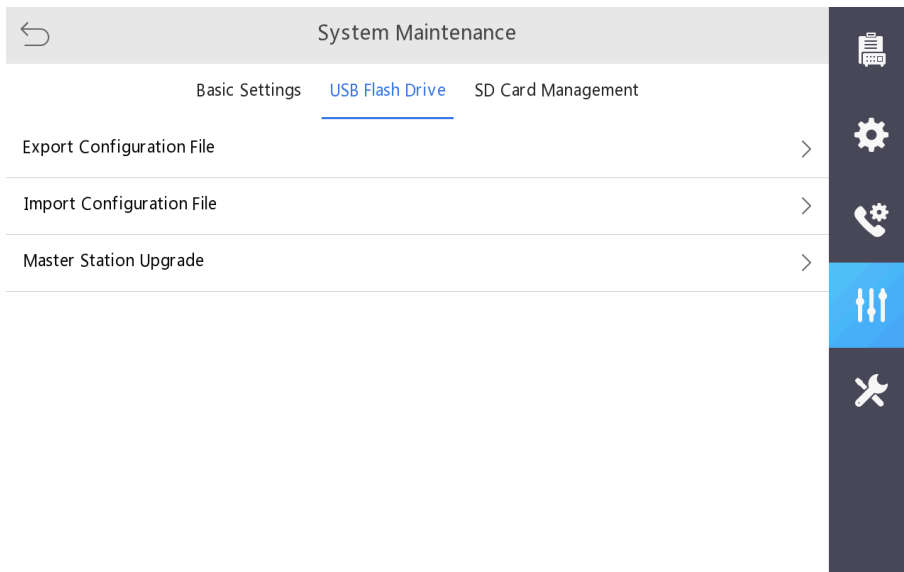

Figure 3-18 USB Flash Driver Management Page

Exporting Configuration File

Purpose:

In this section, you can export the configuration file to USB flash driver.

Steps:

1. On the USB flash driver management page, click > in the Export Configuration File line to pop up a dialog box.
2. Enter a new configuration file name, and click **OK**.
3. Select an USB flash driver to export the configuration file.

4. After exporting the configuration file successfully, click **OK** to close the window.

Notes:

- The configuration file name format: *****.bin. The length of the file name is up to 32 characters (contain 4 byte suffixes).
- The configuration file name cannot contain the characters: \/:*?"<>|.

Importing Configuration File

Purpose:

In this section, you can import the configuration file from the USB flash driver to device.

Steps:

1. On the USB flash driver management page, click > in the Import Configuration File line to pop up a window.
2. Select a configuration file, and click **OK**.
3. After importing the configuration file successfully, click **OK** and the device will reboot. The configuration file will take effect after rebooting.

Notes:

- The configuration file name format: *****.bin. The length of the file name is up to 32 characters (contain 4 byte suffixes).
- The configuration file name cannot contain the characters: \/:*?"<>|.

Upgrading Master Station

Purpose:

In this section, you can upgrade the master station through USB flash driver.

Steps:

1. On the USB flash driver management page, click > in the Master Station Upgrade line to pop up a window.
2. Select an upgrade file, and click **OK**.
3. After upgrading successfully, click **OK** and the device will reboot. The upgrade will take effect after rebooting.

Note: The upgrade file name format: *****.dav.

3.6.3 Managing MicroSD Card

Purpose:

In this section, you are able to view the SD card capacity, valid capacity, status and format SD card.

Before managing the microSD card, you need to insert the microSD card into device.

Steps:

1. On the home page of master station, click **System Config** to enter the page.

2. Tap  to enter the System Maintenance page.
3. Tap **SD Card Management** to enter the SD card management page.

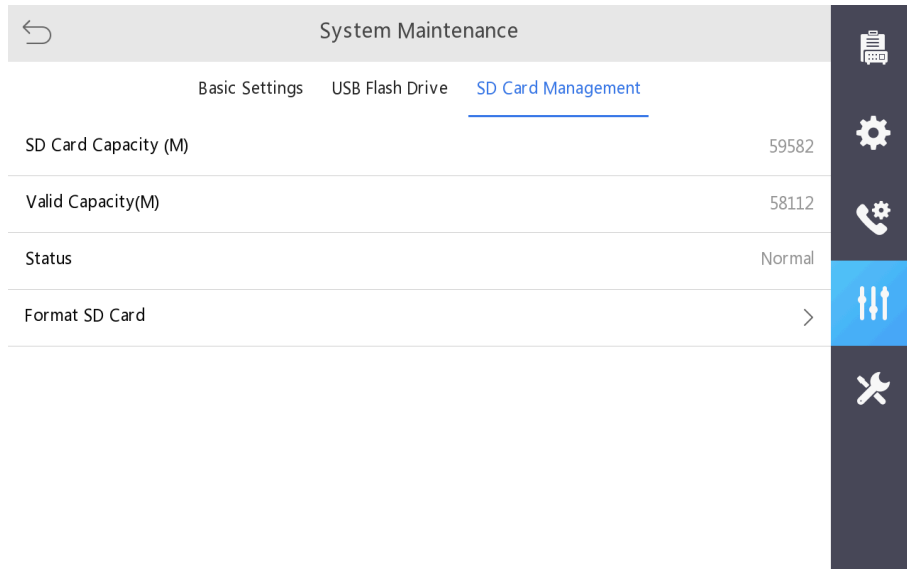



Figure 3-19 SD Card Management Page

Format SD Card: You can format the SD card. Tap > in the Format SD Card line to pop up a window, you can select **OK** to format the SD card or select **Cancel** to cancel the operation.

3.7 Project Configuration

3.7.1 Editing Project Password

Steps:

1. On the home page of master station, click **System Config** to enter the system configuration page.
2. Tap  and enter the project password in the pop-up window to enter the project page.

Note: The default project password is 888999. You can enter the project page to change the project password. For detailed settings, please see *3.7.1 Editing Project Password*.



WARNING

The default project password is only for the first login. To eliminate security risks, please be sure to change the project password after the first login, in order to prevent unauthorized login to your device or other adverse consequences.

3. On the project page, click **Password Settings** to edit the password.

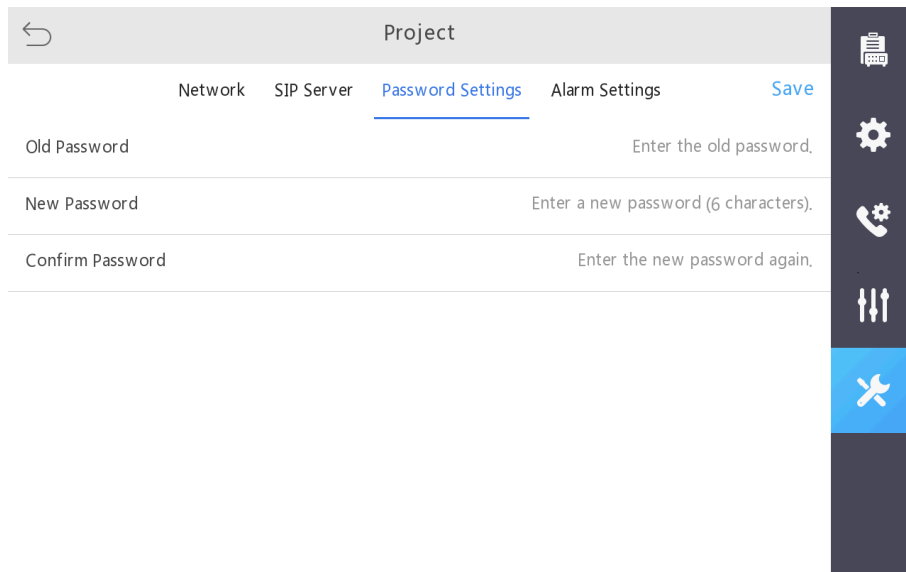

Figure 3-20 Editing Project Password

4. Tap **Save** to save the new password.

3.7.2 configuring IO Input/Output

Purpose:

In this section, you are able to configure the IO input parameters, and the linkage IO outputs of the panic alarm, consultation, hubbub alarm and master station call.

Configuring IO Input Parameters

Steps:

1. On the home page of master station, click **System Config** to enter the system configuration page.
2. Tap  and enter the project password in the pop-up window to enter the project page.

Note: The default project password is 888999. You can enter the project page to change the project password. For detailed settings, please see [3.7.1 Editing Project Password](#).

3. On the project page, click **Alarm Settings**, and click > in the IO Input Settings line to enter the page. You can configure the zone number, zone name, zone type, link device I/O output and link audio file.

IO Input Settings		Copy to	Save
Zone No.		Zone 1	>
Zone Name		Alarm In	
Zone Type		Disabled Zone	>
Detector Type		Other Detector	
Zone Sensitivity		500ms	
Link Device I/O Output		None	>
Link Audio File		None	>

Figure 3-21 IO Input Settings Page

Zone No.: The zone number of the zone needs to be configured.

Zone Name: By default, it is **Alarm In**. The zone name ranges in length from 1 to 32 characters.

Zone Type: You are able to select the zone as **Instant Zone**, **Fire Zone**, **24H Silent Zone** or **Disabled Zone**. By default, it is **Disabled Zone**.

Link Device I/O Output: By default, it is **None**. The link device I/O output supports multiple choice.

Link Audio File: By default, it is **None**. You are able to select the link audio file in the pop-up Audio File window.

Copy to: You can click **Copy to...** to copy the parameters to other zones.

Configuring Alarm Linkage

Purpose:

If the master station connects external alarm output device, you are able to configure the linkage IO outputs of the panic alarm, consultation, hubbub alarm and master station call. When the alarm device initiates a panic alarm call, consultation, triggers a hubbub alarm, or receiving a master station call, the linked alarm output will respond.

Steps:

1. On the project page, click **Alarm Settings**, and click > in the Alarm Linkage line to enter the page.

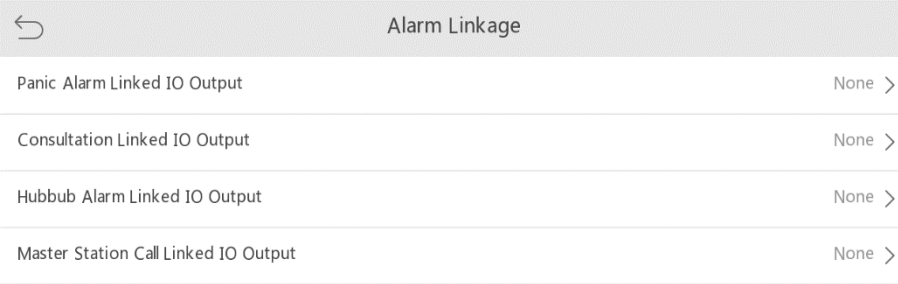

Alarm Linkage	
Panic Alarm Linked IO Output	None >
Consultation Linked IO Output	None >
Hubbub Alarm Linked IO Output	None >
Master Station Call Linked IO Output	None >

Figure 3-22 IO Input Settings Page

2. Tap > to select the linked alarm outputs for the panic alarm/consultation/hubbub alarm/master station call.

Notes:

- By default, the linked alarm output is **None**. The linked alarm output supports multiple choice.
- If the master station answers the call, hang up the call, transfer the call or timeout, the corresponding IO output stops responding.

Chapter 4 Local Operation

4.1 Video Call

In this section, you can listen, announce the alarm device, and start live view of the alarm device. And you can also start audio or video call with other master stations.

4.1.1 Video Call with Alarm Device

Steps:

1. On the home page of master station, click **Audio/video** to enter the page.
2. Tap  to enter the group list of alarm devices, select a group and tap > in the selected group line to enter the group.
3. Tap an alarm device in the device list to enter the video call page.

When there are multiple devices, you can click  and enter the device information (device ID, name, IP address or location) through the soft keypad to search the device, and then click the device to enter the device video call page.

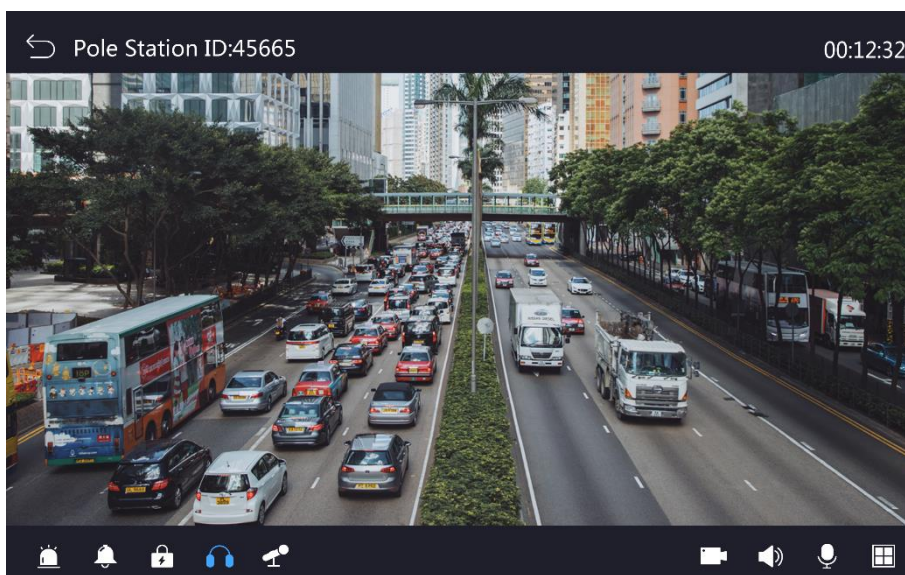











Figure 4-1 Video Call with Alarm Device (with Camera)

Video will appear for devices with camera, and static background picture will appear for devices without camera. The function buttons displayed on the page include: Strobe light , siren , electrical lock , listening  and intercom .



Strobe light: Tap  to turn on/off the strobe light.

Siren: Tap  to turn on/off the siren.



Electrical clock: Tap  to turn on the electrical clock and you will receive a voice prompt “operate succeeded”; you can click  again to turn off the electrical clock within 10 s.

Listening: You can click  to enable the listening and get the alarm device video and audio. By default, it is turned on. Listening will be automatically turned off when enabling the intercom.

Intercom: Tap  to enter the intercom state, you start video intercom with the alarm device.

On the video call page, you are able to click  to adjust the microphone volume of alarm device, or click  to adjust the speaker volume of alarm device. The available volume is between 0 and 10, 0 represents mute mode, and 10 is the maximum volume.

Notes:

- The function buttons actually displayed on the video call page are determined by the functions supported by the alarm device. The function buttons , ,  can be used when the alarm device has the strobe light, siren and electrical lock.
- When the function button is blue, it means the function is on; otherwise, it means the function is off.

4. **Optional:** You can click  to enter the window division page.

On the window division page, the live view window is divided to four smaller windows, you can click “+” in the center of the divided window to add other alarm devices or network cameras; select one of the divided window and click “×” on its upper right corner to close the window, or click  on its button right to display the window in full screen.

5. **Optional:** You can click  to manually turn on the video call record.

6. Tap  to exit the video call.

Note: When the master station is in the status of listen, announcement, live view in window divided mode or announcement quick-switch, it can receive calls of up to 4 alarm devices or master stations.

4.1.2 Video Call with Master Station

Steps:

1. On the home page of master station, click **Audio/video** to enter the page.

2. Tap  to enter the page.

3. Starting a video call with master station.

1) Tap a master station in the list to enter the call page.

The caller can hang up the call when the called device does not answer, and the called device can choose to reject or answer the call. The call ends when the called device does not respond or the call is rejected.

2) The called master station answers the call, and the device will enter the video call page to start a video call.

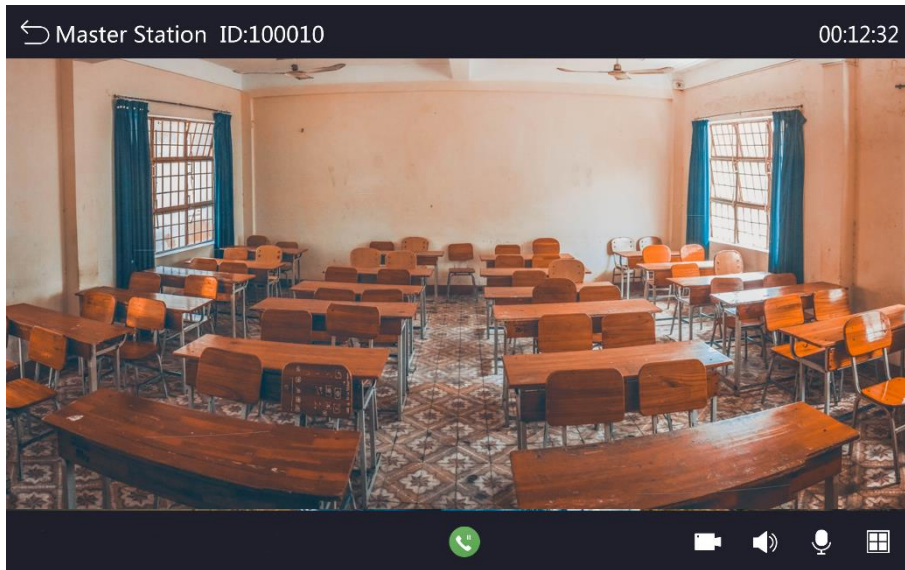





Figure 4-2 Video Call with Master Station

On the video call page, you are able to tap  to adjust the microphone volume of the other end of the master station, or tap  to adjust the speaker volume of the other end of the master station. The available volume is between 0 and 10, 0 represents mute mode, 10 is the maximum volume.

4. **Optional:** On the video call page, you can tap  to start the call waiting, and tap it again to end the call waiting, and then return to the current call.

When you start the call waiting, you can select a waiting call to make a call, or you can tap the broadcast button to make an announcement quick-switch for the preset group.

Note: When the call is in call waiting status, the master station still displays the live view of the other end, but cannot hear the sound. And the master station on the other end will play the configured call waiting audio file. The two ends cannot carry on the intercom.

5. Tap  to exit the video call.

Note: When the master station is in the status of call, video call, call waiting or announcement quick-switch, it can receive calls of up to 4 alarm devices or master stations.

4.2 Quick Dialing

Steps:

1. On the home page of master station, tap **Dial-up** to enter the page. You can also pick up the handset to enter the page.
2. Enter the device ID number (or group number) on the right numeric buttons, and the searched devices (or groups) will be displayed in the left list.

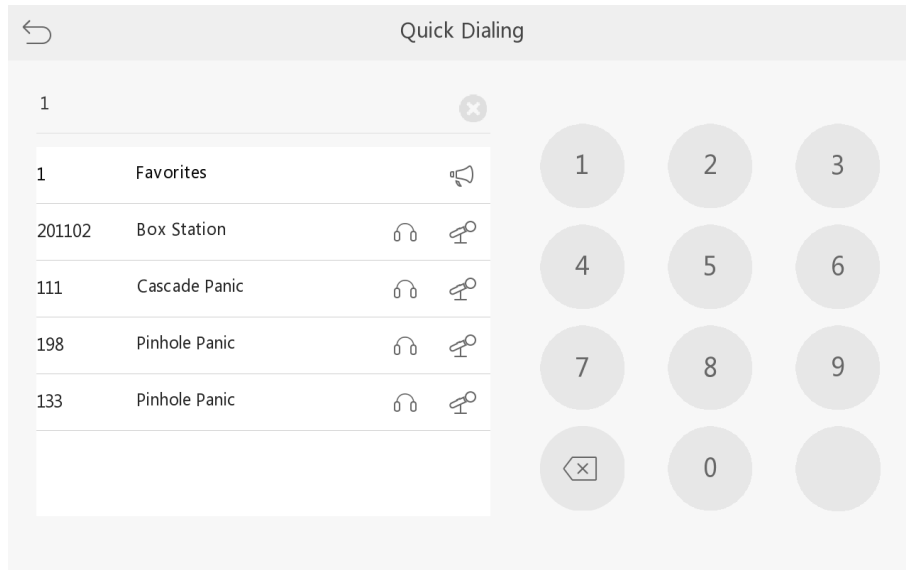

Figure 4-3 Quick Dialing

3. Tap  to listen the alarm device, or tap  to start video intercom with the alarm device.

You can also tap  to broadcast the alarm device in the group.

4.3 Broadcasting

The master station supports group broadcasting and temporary broadcasting for the alarm devices, and the announcement quick switch broadcasting.

4.3.1 Group Broadcasting

The master station supports group broadcasting. You are able to select an alarm device group to broadcast.

Steps:

1. On the home page of master station, tap **Broadcast** to enter the page.
2. Tap  to enter the page.
3. Tap an alarm device group to enter the page.
4. Tap **Start Broadcast** on the upper right corner to select **Announcement Broadcast** or **Audio Broadcast** in the pop up Broadcast Mode window.

- Select **Announcement Broadcast**

Tap **Announcement Broadcast** to enter the Broadcasting page, you can announce all alarm devices in the group through the audio input of the master station.

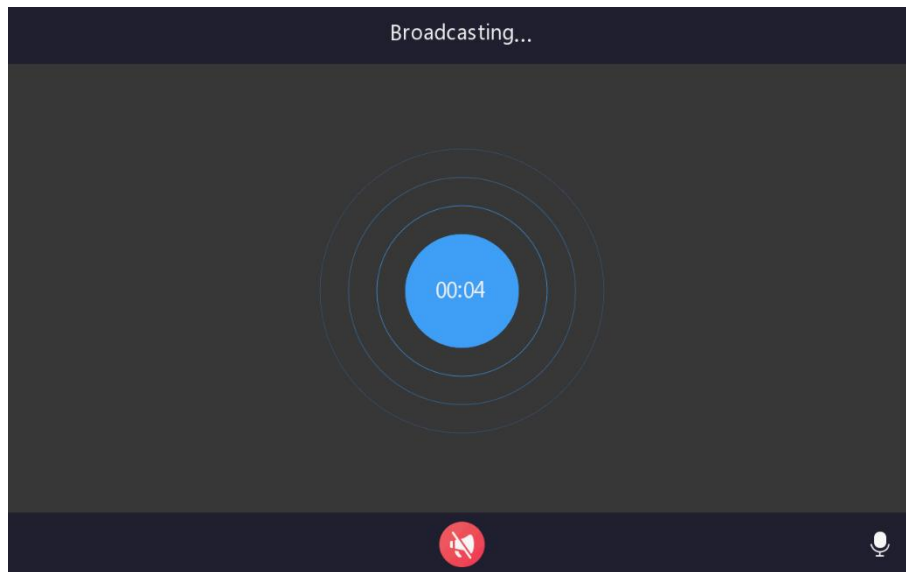

Figure 4-4 Broadcasting Page (Announcement Broadcast)

On the announcement broadcast page, you can tap  on the button right to adjust the announcement volume, or tap  to stop broadcasting.

- Select **Audio Broadcast**

Tap **Audio Broadcast**, you can select an audio file for broadcasting in the pop-up Audio File window, and tap **OK** to enter the page, the master station will play the audio file for all alarm devices in the group.

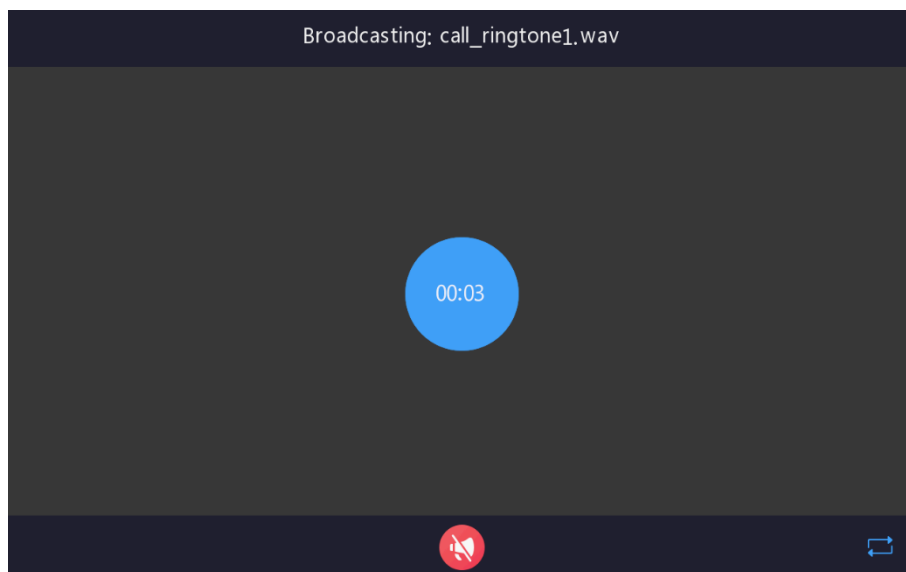



Figure 4-5 Broadcasting Page (Audio Broadcast)

On the audio broadcast page, you can tap  on the button right to close audio loop (By default, the audio loop is enabled), or tap  to stop broadcasting.

Notes:

- In the process of group broadcasting, it can receive calls of up to 4 alarm devices or master stations. The broadcast will stop after answering the call.
- The local audio file comes with the device. The SD card audio file requires to be uploaded, and you need to insert the SD card into the microSD card interface for using the SD card audio file.

4.3.2 Temporary Broadcasting

The master station supports temporary broadcasting. You are able to select one or more alarm devices to broadcast.

Steps:

1. On the home page of master station, tap **Broadcast** to enter the page.
2. Tap  to enter the page.
3. You can check one or more groups or check one or more device alarms in the different groups to broadcast.
4. Tap **Start Broadcast** on the upper right corner to select **Announcement Broadcast** or **Audio Broadcast** in the pop up Broadcast Mode window.

You can see 4.3.1 step4 to start temporary broadcasting.

Note: In the process of temporary broadcasting, it can receive calls of up to 4 alarm devices or master stations. The broadcast will stop after answering the call.

4.3.3 Announcement Quick Switch Broadcasting

When the master station is not calling, you can tap the broadcast button (on the right side of the front panel of the master station) to broadcast all the alarm devices in the group.

You can see *Configuring Announcement Quick Switch* to configure the group of announcement quick switch broadcasting.

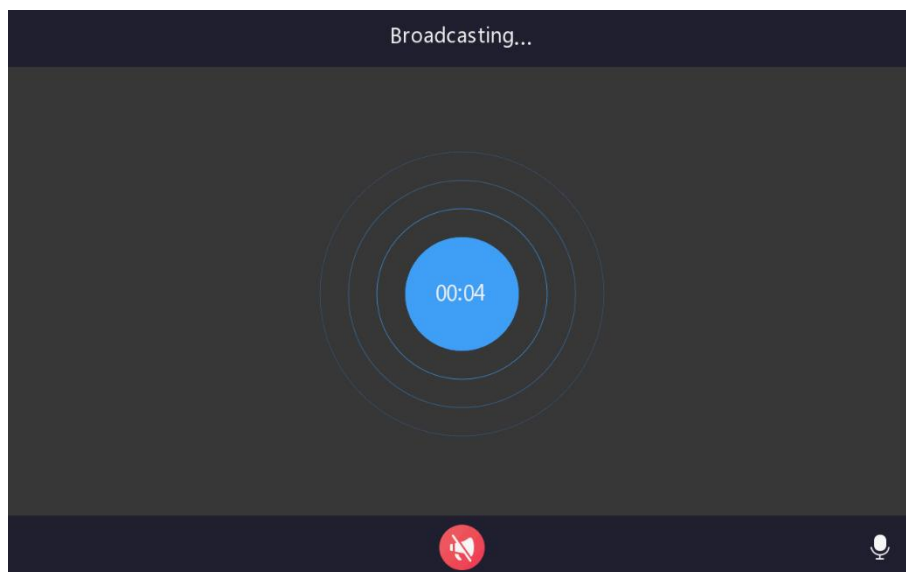



Figure 4-6 Broadcasting Page (Announcement Quick Switch Broadcast)

On the announcement quick switch broadcast page, you can tap  on the button right to adjust the announcement volume, or tap  to stop broadcasting.

Notes:

- The announcement quick switch broadcast cannot use the audio file.
- On the process of announcement broadcast, it can receive calls. The broadcast will stop after answering the call.

4.4 Receiving Panic Help or Consultation

Up to 4 calls can be handled at the same time.

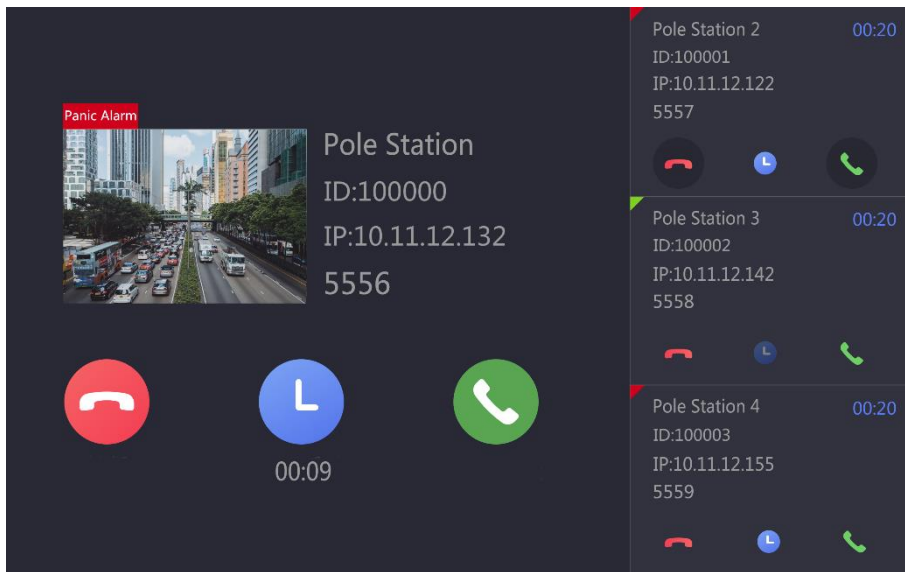



Figure 4-7 Receiving Call Page

You can answer, hang up, transfer the call or start call waiting.

4.4.1 Answering Call

Steps:

1. On the Receiving Call page, tap  to enter the page and handle the panic help or consultation.

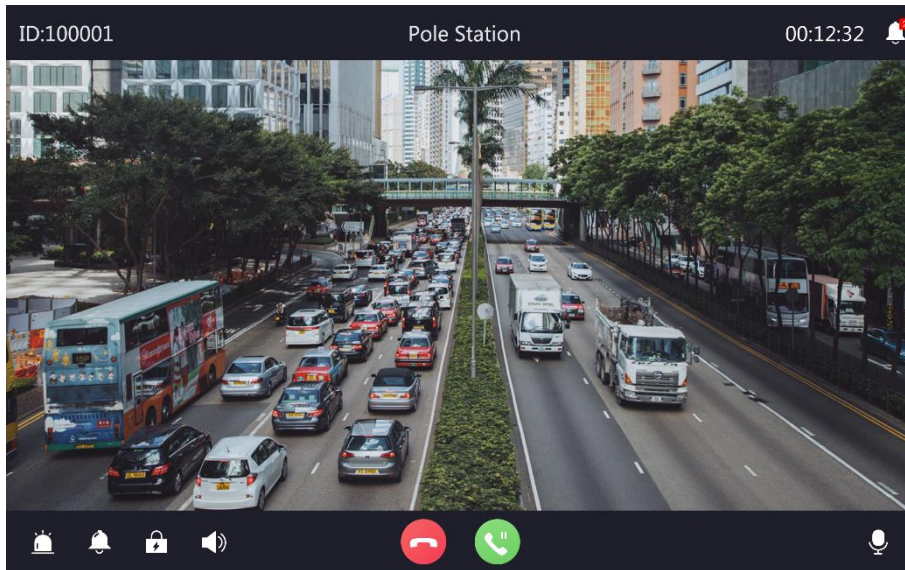











Figure 4-8 Call Page

When receiving a panic help from alarm devices, the function buttons displayed on the page include: Strobe light , siren , electrical lock . When answering the call from master station, the page does not display this function buttons.



Strobe light: Tap  to turn on/off the strobe light.

Siren: Tap  to turn on/off the siren.

Electrical clock: Tap  to turn on the electrical clock and you will receive a voice prompt “operate succeeded”; you can tap  again to turn off the electrical clock within 10 s.

On the call page, you are able to tap  to adjust the microphone volume of alarm device, or tap  to adjust the speaker volume of alarm device. The available volume is between 0 and 10, 0 represents mute mode, 10 is the maximum volume.

Notes:

- The function buttons actually displayed on the video call page are determined by the functions supported by the alarm device. The function buttons , ,  can be used when the alarm device has the strobe light, siren and electrical lock.
- When the function button is blue, it means the function is on; otherwise, it means the function is off.
- Video will appear for devices with camera, and static background picture will appear for devices without camera.

2. **Optional:** On the video call page, you can tap  to start the call waiting, and tap it again to end the call waiting, and then return to the current call.

When you start the call waiting, you can select a waiting call to make a call, or you can tap the broadcast button to make an announcement quick-switch for the preset group.

3. Tap  to end the call.

4.4.2 Hanging up Call

On the Receiving Call page, tap  to end the call and exit the call page.

4.4.3 Call Forwarding

If the master station is busy, you can transfer the alarm call from the current master station to another master station. The alarm device should enable the call forwarding function in advance and configure the priority of call forwarding master station. For detailed settings, please see *Setting Call Forwarding of Alarm Device*.

On the Receiving Call page, tap  to transfer the call to other master station according to the configured priority.

Note: If you does not configure the call forwarding priority for the alarm device, the Receiving Call page displays the call wait button .

4.4.4 Call Waiting

If the master station is busy, when receiving a call from alarm device which does not configure the call forwarding or receiving a call from master station, you can tap  on the Receiving Call page, and the call will enter the delayed waiting state.

If the panic help call is waiting for processing (or in the delayed waiting state), and there is another panic help call/consultation/master station call, you can choose to handle any of them.

4.5 Record Query

You can view alarm records and call records on the master station.

4.5.1 Alarm Record Query

Purpose:

In this section, you can search for alarm records, including panic alarm, hubbub alarm, local zone alarm, remote panel alarm and tamper alarm. Each alarm event supports the storage of up to 512 alarm records.

Steps:

1. On the home page of master station, tap **Message** to enter the page.
2. Tap  to enter the alarm record page.

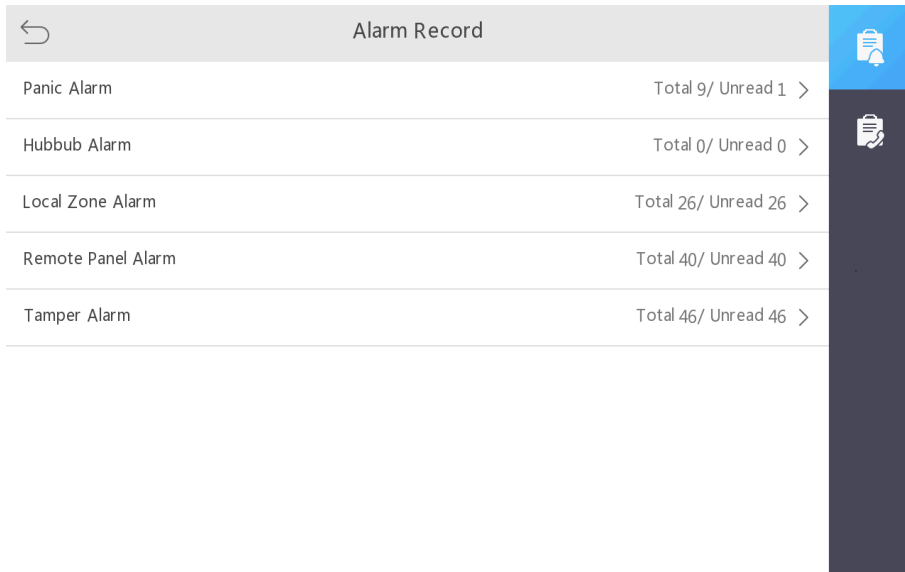

Figure 4-9 Alarm Record Page

3. You can tap > to enter the alarm record list of corresponding alarm events to view the alarm record.



Figure 4-10 Alarm Record List (Panic Alarm)

Note: You can tap 🔍 on the upper right corner and enter the information (device ID number, location, alarm type) to search the alarm record. Fuzzy search is supported.

4. **Optional:** Long press a record in the list, you can choose to delete the selected record or delete the record in batch.

5. **Optional:** In the alarm record list, you can tap 📞 to start a call with the corresponding device, or tap 📺 to play back the video record stored on the SD card.

Note: local zone alarm, remote panel alarm and tamper alarm cannot be played back.

4.5.2 Call Record Query

Purpose:

In this section, you can search for the call records, including master station ringing and dialing record, consultation record. Each records can support the storage of up to 512 alarm records.

Steps:

1. On the home page of master station, tap **Message** to enter the page.
2. Tap  to enter the call record page.

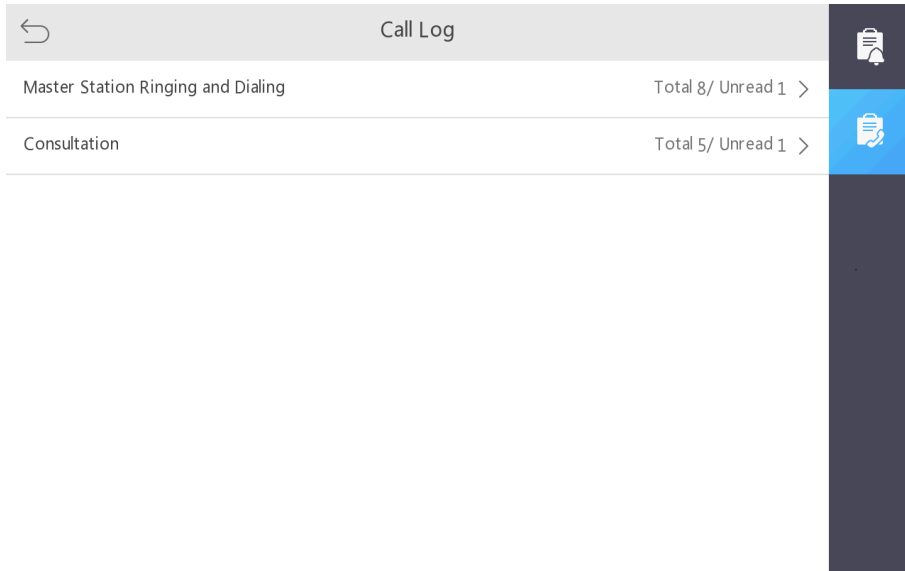

Figure 4-11 Call Record Page

3. You can tap > to enter the call record list of corresponding call record type to view the call record.

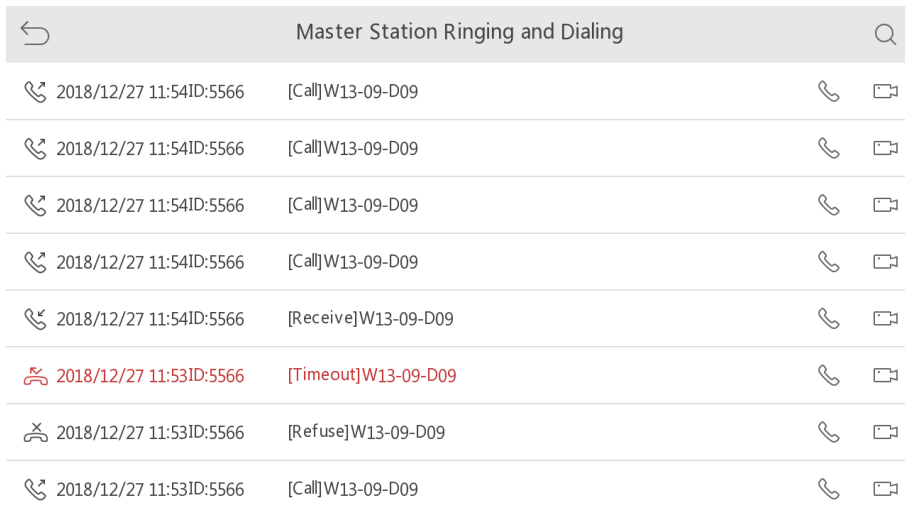





Figure 4-12 Call Record List

4. **Optional:** You can tap  on the upper right corner and enter the information (device ID number, location, alarm type) to search the call record. Fuzzy search is supported.
5. **Optional:** Long press a record in the list, you can choose to delete the selected record or delete the record in batch.

6. **Optional:** In the call record list, you can tap  to start a call with the corresponding device, or tap  to play back the video record stored on the SD card.

Note: The master station dialing records cannot be played back.

4.6 Local Playback

You can play back the alarm video records or call video records on the master station.

Steps:

1. On the home page of master station, tap **Playback** to enter the page.

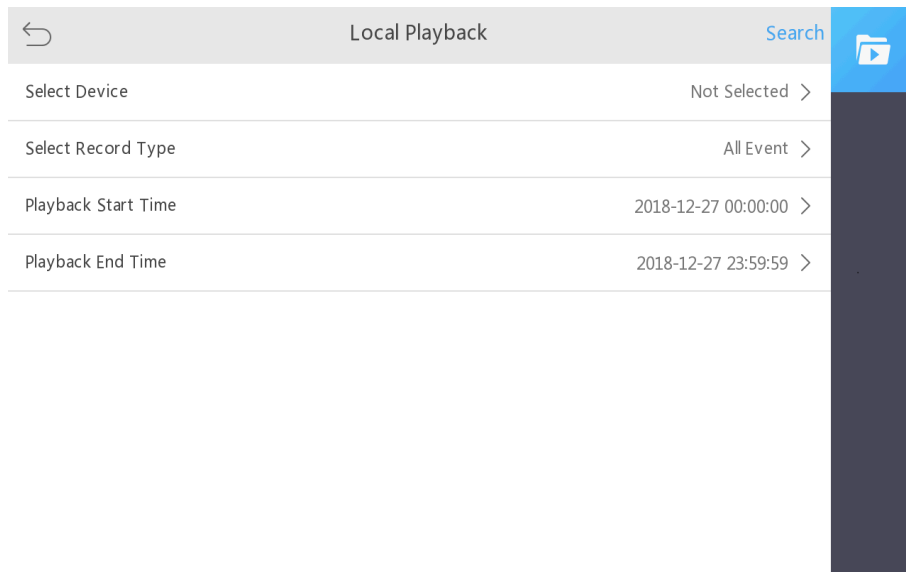

Figure 4-13 Local Playback Page

2. Set the search criteria for playback video.

- 1) Tap > in the Select Device line, and select an alarm device or master station on the Select Device page.
- 2) Tap > in the Select Record Type line, and select the record type.
- 3) Set the playback start time and playback end time.

3. Tap **Search**, the search results list will display all eligible video records stored on the local SD card.

4. Tap on any file for video playback.

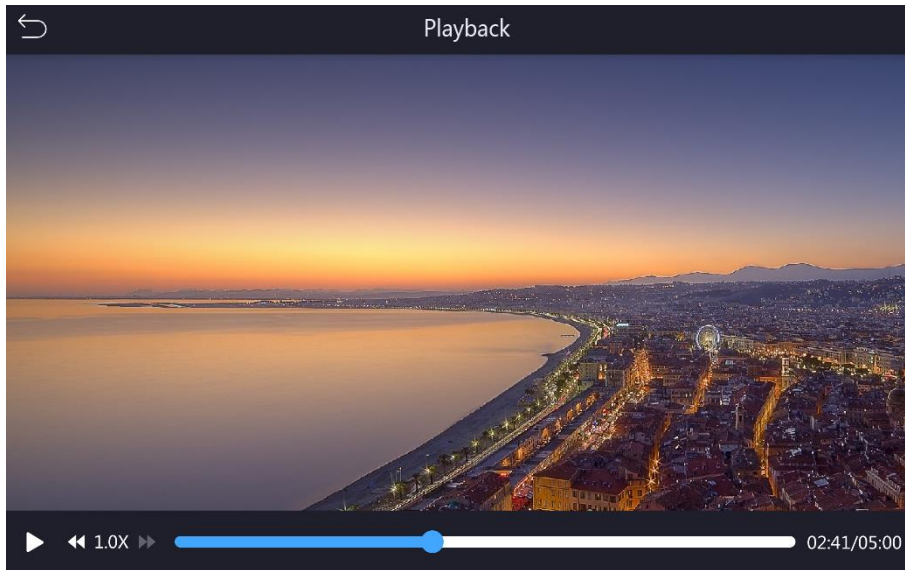





Figure 4-14 Local Video Playback

The video file will play the stored video and audio. During playback, the master station can receive call, and exit the current video playback after answering the call. The master station can receive up to 4 calls at the same time.

You can tap  to exit the video playback, tap the pause button to pause the playback, and slide the progress bar to select the playback time. You can also control the playback speed (1.0x, 2.0x, 4.0x) by  and .

Note: The reverse play is not supported.

Chapter 5 Master Station Configuration via Client Software

You can configure the master station via client software.

The master station should be activated the first time it is used to log in and use properly. See *Chapter 2 Activation* to activate the master station.

Get the client software from the technical support, and install the software according to the prompts.

5.1 Adding Master Station to Client Software

On Control Panel page of the client software, click **Device Management** to enter the device management page.

You can add the master station to client software by several methods on the device management page. In this section, two common methods of adding device are introduced. For more methods, please refer to *User Manual of iVMS-4200 Client Software*.

Note: Before adding the master station, please ensure that the device and the PC is in the same subnet.

5.1.1 Adding Master Station by Online Search

Steps:

1. Enter the device management page, click **Device** tab and select **Hikvision Device** as the device type to display the **Online Device** area.
2. Select an online device from the **Online Device** area.
3. Click **Add to Client** to open the device adding window. You should enter IP address, user name and password of the master station.

Nickname: Edit a name for the device as you want.

Address: Enter the device's IP address or domain name. The IP address of the device is obtained automatically in this adding mode.

Port: Enter the device port number. The default value is 8000.

User Name: The default user name is admin.

Password: the device password.

4. Click **Add** to add the master station.

5.1.2 Adding Master Station by IP address or Domain Name

Steps:

1. Enter the device management page, click **Device** tab and select **Hikvision Device** as the device type to display the **Device for Management** area.
2. Click **Add** to open the Add window, Select **IP/Domain** as the adding mode, input the required information, including nickname, IP address, port number, user name, and password.

Nickname: Edit a name for the device as you want.

Address: Enter the device's IP address or domain name.

Port: Enter the device port number. The default value is 8000.

User Name: The default user name is admin.

Password: the device password.

3. Click **Add** to add the device.

5.2 Remote Configuration via Client Software

Purpose:

In this section, you are able to configure device parameters remotely, including time parameters configuration, device information modification, password management (Max. password attempts and the locking time configuration), password editing, system maintenance, network parameters and SIP server parameters configuration, video and audio parameters configuration, audio file of microSD card management and video standard configuration.

On Control Panel page of the client software, click **Device Management** to enter the device management page. Select the master station in Device for Management list, and click **Remote Configuration** to enter the remote configuration page.

You should add the master station to client software before configuring it remotely.

5.2.1 Viewing Device Information

On the remote configuration page, click **Device Information - Device Information** to view the basic information and version information of the master station.

Displaying the Device Information

Basic Information

Device Type:	<input type="text"/>	Local Zone Number:	<input type="text" value="4"/>
Local Trigger Number:	<input type="text" value="4"/>	Analog Camera Nu...	<input type="text" value="1"/>
Network User Number:	<input type="text" value="1"/>		
Device Serial No.:	<input type="text"/>		

Version Information

Firmware Version:	<input type="text"/>
Hardware Version:	<input type="text"/>

Figure 5-1 Device Information

5.2.2 Configuring Time Settings

On the remote configuration page, click **Device Information - Time** to configure the time settings, including time zone, NTP and DST.

Configuring the Time Settings (e.g., NTP, DST)

Time Zone

Select Time Zone: (GMT+08:00) Beijing, Hong Kong, Pert... ▾

Enable NTP

Server Address: 0.0.0.0

NTP Port: 123

Sync Interval: 60 Minute(s)

Test

Enable DST

Start Time: April ▾ First Week ▾ Sun ▾ 2 : 00

End Time: October ▾ Last Week ▾ Sun ▾ 2 : 00

DST Bias: 60 min ▾

Synchronization Save

Figure 5-2 Time Configuration

Editing Time Zone

Purpose:

You are able to synchronize the time to the selected time zone.

Steps:

1. Select a time zone from the drop-down box.
2. Click **Synchronization**, and click **save**.

Enable NTP

Purpose:

You are able to enable NTP to enable automatic synchronization, which periodically synchronizes time from the NTP server based on the synchronization interval.

Steps:

1. Check **Enable NTP**.
2. Enter the IP address or domain name, port number of the NTP server, and set the synchronization interval.

Server Address/Domain Name: IP address or domain name of the NTP server. By default, it is 0.0.0.0. Domain names range in length from 0 to 64 characters.

NTP Port: The default value is 123, the available NTP port number is between 1 and 65535.

Sync Interval: The default value is 60 min, the available interval is between 1 and 10080 min.

3. Click **Test**. Test whether the connection is successful to the NTP server.
4. Click **Save**.

Enable DST

Purpose:

You are able to enable DST (Daylight Saving Time).

Steps:

1. Check **Enable DST**.
2. Select the start time, end time and the DST bias.
3. Click **Save**.

5.2.3 Editing General Settings

Purpose:

You are able to edit the device name, device number, and configure the video files.

Steps:

1. On the remote configuration page, click **System - General Parameters** to enter the page.
2. Edit the device name and device number, and select **Yes** or **No** from the Overwrite Record Files drop-down box.

If selects **Yes**, the new video file will overwrite the earliest video file when the device storage is full.

3. Click **Save** to save the settings.

5.2.4 Enable SSH

Purpose:

You are able to enable/disable SSH service, which is used to provide security configuration.

Steps:

1. On the remote configuration page, click **System - Security** to enter the page.
2. Check **Enable SSH**. By default, the SSH service is not enabled. The default setting will be restored after the restart.
3. Click **Save** to save the settings.

5.2.5 Configuring the Password Management

Purpose:

In this section, you can set the maximum password attempts, the lock duration of the locked user. And you can unlock the user remotely.

Steps:

1. On the remote configuration page, click **System – Password Management** to enter the page.

The screenshot shows a web configuration page titled "Configuring the Password Management". At the top, there is a checkbox labeled "Access Lock" which is checked. Below it are two input fields: "Max. Password Attempts" with the value "7" and "Lock For" with the value "1800" followed by a small "s" for seconds. Underneath these fields is a table with two columns: "IP Address" and "Unlock". The table is currently empty. At the bottom right of the page, there are two buttons: "Save" and "Unlock All".

Figure 5-3 Password Management Configuration

Access Lock: Check **Access Lock** to enable the access lock, you can set the user lock parameters, including Max. Password Attempts and the lock duration.

Max. Password Attempts: The maximum times that the user attempts to enter the password. By default, it is 7, the available value is 3 to 10.

Lock For: The lock duration of the locked user. By default, it is 1800 s, the available value is 10 to 3600 s.

IP Address: The IP address of the terminal in which the locked user logs.

Unlock: Unlock the user's login lock status on the corresponding IP address.

2. Click **Save**.
3. **Optional:** Click **Unlock All** to unlock all user at once.

5.2.6 Editing the User

Purpose:

In this section, you are able to change the user password.

Steps:

1. On the remote configuration page, click **System - User** to enter the page.
2. Select a user and click **Edit**, you can change the password on the pop-up User Parameter page.
3. Click **Save**.

5.2.7 System Maintenance

Purpose:

In this section, you are able to reboot the device remotely, restore default settings, restore all parameters, import/export configuration file and upgrade the device remotely.

On the remote configuration page, click **System – System Maintenance** to enter the System Maintenance page.

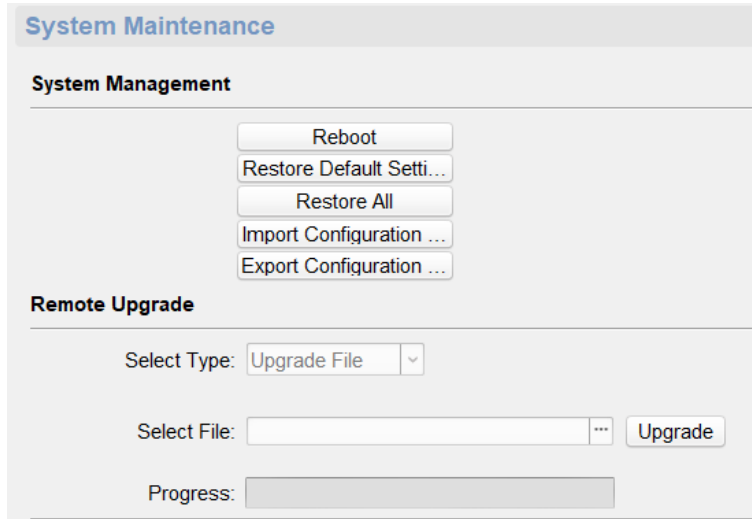

Figure 5-4 System Maintenance Page

System Management

Reboot: Click **Reboot** to restart the device.

Restore Default Settings: Click **Restore Default Settings** to restore the default settings.

Note: Except the IP address, all other parameters of the device will be restored to factory default settings.

Restore All: Click **Restore All** to restore all the parameters to factory default settings.

Note: After restoring the parameters to default, the device needs to be reactivated after restarting.

Import Configuration File: The device supports importing the configuration file. Click **Import Configuration File** to import the file.

Export Configuration File: The device supports importing the configuration file. Click **Export Configuration File** to export the file.

Note: The configuration file contains the parameter information of the device.

Upgrade the Device Remotely

Steps:

1. Click  to select the local upgrading file.
2. Click **Upgrade** to upgrade the device.

Note: An invalid upgrade occurs when using a mismatched upgrade file, and then the device program is still the program before the upgrade.



WARNING

Do not power off the device during the upgrade.

5.2.8 Editing Network Parameters

Purpose:

In this section, you are able to edit the general network parameters.

Steps:

1. On the remote configuration page, click **Network – General** to enter the page.
2. Edit the IP address, subnet mask, gateway, port number.

Note: After editing the port number, the device needs to reboot.

3. Click **Save**.

5.2.9 Configuring SIP Server

Purpose:

After Configuring the SIP server parameters, the master station will register to the SIP server, and communicate with other devices which register to the same SIP server.

Note: Before configuring SIP server, you should refer to *5.3.10 Configuring Intercom Protocol* to select the intercom protocol type.

Steps:

1. On the remote configuration page, click **Network – SIP Settings** to enter the page.

Note: the SIP parameters need to be configured will vary as the selected intercom protocol type.

Configuring the SIP Parameters

Note: The connection to 28181 will be disabled if you start SIP conn...

Login Status: Registered

Server: IP Address

Ip Addr: 10.22.97.214

Server Port: 5065

Local No.: 0

Display Name: f5

Login Cycle: 10 Minute(s)

Save

Figure 5-5 SIP Parameters Configuration (Private Protocol)

Configuring the SIP Parameters

Note: The connection to 28181 will be disabled if you start SIP conn...

Login Status: Unregistered

Server: IP Address

Ip Addr: 10.22.97.214

Server Port: 5065

User Name:

Password:

Save

Figure 5-6 SIP Parameters Configuration (SIP Protocol)

Login Status: Indicate the register status of the device, if the device has registered to the SIP server, displays **Registered**, otherwise, displays **Unregistered**.

2. Select the server address type as **IP Address** or **Domain Name** from the drop-down box.
3. According to the selected address type, enter the IP address or domain name of the SIP server.
4. Enter the server port number, by default, it is 5065, the available server port should be between 1024 and 65535.
5. If configuring the SIP parameters based on Private Protocol, please enter the local no., display name and login cycle. IF configuring the SIP parameters based on SIP Protocol, please enter the user name and password.

Local No.: Device ID, the available number should be between 0 and 999999.

Note: Device ID is the unique identification of the device, facilitating the communication between the master station and the alarm device.

Display Name: You can enter the position information of the device for easy management, the display name ranges in length from 1 to 32 characters.

Login Cycle: The interval that the device continuously registers to the SIP server, the login cycle ranges from 1 to 30 (min).

User Name: The user name which the device registers to the SIP server. The available user name should be between 0 and 999999.

Password: The password which the device registers to the SIP server.

6. Click **Save**.

Note: You can also configure the SIP server parameters locally, for detailed settings, please refer to 3.2 *Setting SIP Server and Master Station ID*.

5.2.10 Configuring Intercom Protocol

Purpose:

In this section, you are able to select the intercom protocol of the master station as private protocol or SIP protocol.

Steps:

1. On the remote configuration page, click **Network – Intercom Protocol** to enter the page.

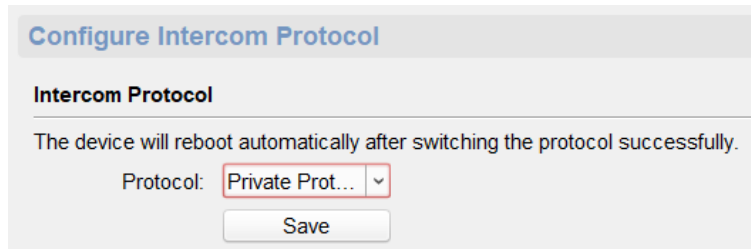

Figure 5-7 Intercom Protocol Configuration

2. Select the Protocol as **Private Protocol** or **SIP Protocol** from the drop-down box.
3. Click **Save**.

Note: The device will reboot automatically after switching the protocol successfully.

5.2.11 Setting Video & Audio Parameters

Purpose:

In this section, you are able to configure the image quality, resolution and other parameters of the camera.

Steps:

1. On the remote configuration page, click **Image – Video & Audio** to enter the page.

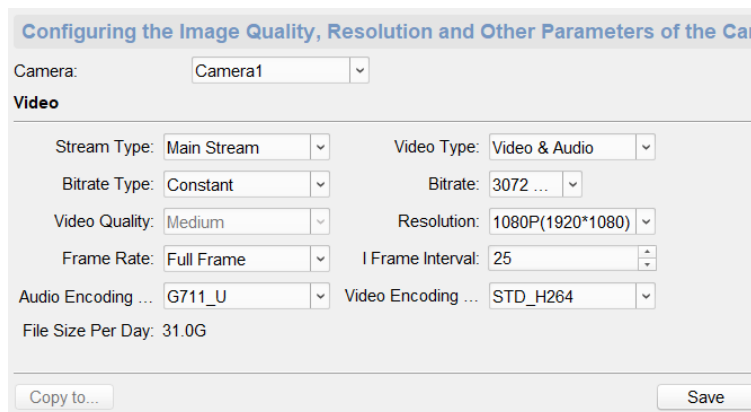

Figure 5-8 Video & Audio Parameters Configuration

2. Select a camera from the drop-down box to configure the audio and video parameters of the camera.
3. Configure the parameters, including stream type, video type, bitrate type, bitrate, video quality, resolution, frame rate, frame interval, audio encoding type and video encoding type.

Stream Type: the stream type of camera can be set as **Main Stream** or **Sub Stream**. By default, it is Main Stream.

Video Type: the video type can be set as **Video** or **Video & Audio**. By default, it is **Video & Audio**, where video contains sound and images. If you don't need sound, choose **Video Stream**.

Bitrate Type: the bitrate type can be set as **Constant** or **Variable**. By default, it is **Constant**, where you should select a constant value from the Bitrate drop-down box. You are supposed to select the maximum bitrate when the bitrate type is set as **Variable**.

Video Quality: You are able to choose different level of the video quality. The video quality is not optional by default when the bitrate type is constant.

Resolution: When the stream type is video & audio, the resolution can be set as 1080P, HD720P or 4CIF. When the stream type is video, the resolution can be set as 4CIF, CIF, VGA or QVGA.

Audio Encoding Type: When the stream type is video & audio, the audio encoding type can be set as **G711_U** or **G726**. When the stream type is video, the audio encoding type can be set as **G711_U**.

Video Encoding Type: By default, it is STD_H264.

File Size Per Day: According to the video and audio parameters, the video file size of the whole day will be automatically calculated.

Notes:

- After editing the video and audio parameters, the device won't reboot.
- Please combine the actual demand and storage capacity to configure the video and audio parameters.

4. Click **Save**.

5. **Optional:** Click **Copy to...** to copy the parameters to other camera.

5.2.12 Setting Video Display Parameters

Purpose:

In this section, you are able to edit the display information of the camera, and configure the video parameters of the camera, including brightness, contrast and so on.

Configuring the Display Parameters

Steps:

1. On the remote configuration page, click **Image – Video Display** to enter the page.

Configuring the Display Parameters, including OSD, Privacy Mask, etc.

Camera:

Display Camera Name
 Display Date
 Display Week

Text Overlay:

Camera Name:
Date Format:
Time Format:
OSD Attribute:

Figure 5-9 Video Display Parameters Configuration

2. Select a camera from the drop-down box to configure the display parameters of the camera, including display position, display format and optional display content, you are able to add custom display information.
 - Editing the display position

Drag the blue box on the live view page to change the position of the display information, click **Save**, and then the position of the display information will be updated.
 - Editing the display format

Date Format: Select the display format of the date in the Date Format Drop-Down box.

Time Format: Select the Time Format as **24-hour** or **12-hour**.

OSD Format: Select the OSD Format as **Transparent & Flashing**, **Transparent & Not Flashing**, **Non-Transparent & Flashing** or **Non-Transparent & Not Flashing**.
 - Editing the display content

You are able to select the display content optionally, edit the camera name, and add the custom display content.

 - Selecting the display content

According to your requirement, select and check Display Camera Name, Display Date, Display Week to display the selected display content.
 - Editing the camera name

Editing the camera name in the Camera Name textbox.
 - Adding custom display content

Click the right area of the check box in the Text Overlay List and enter display content in the textbox. Check and click **Save** to display the custom information.
3. Click **Save**.
4. **Optional:** Click **Copy to...** to copy the display configuration to other camera.

Configuring the Video Parameters

Steps:

1. On the remote configuration page, click **Image – Image Settings** to enter the page.
2. Select a camera to configure the video parameters, including brightness, contrast, saturation and hue.

Slide the slider or click the adjustment bar to edit the video parameters.

Notes:

- The value of video parameters ranges from 1 to 10.
 - By default, the brightness is 7, the contrast is 1, the saturation is 5, the hue is 6.
3. **Optional:** Click **Default Value** to restore all video parameters to default.

5.2.13 Setting Intercom Audio Encoding Type

Purpose:

In this section, you are able to set the intercom audio encoding type as G711_U/G726/AAC/OPUS.

Steps:

1. On the remote configuration page, click **Image – Intercom Audio** to enter the page.
2. Select the Audio Encoding Type as **G711_U**, **G726**, **AAC** or **OPUS** from the drop-down box.
3. Click **Save**.

5.2.14 Managing MicroSD Card Audio File

Purpose:

In this section, you are able to upload custom audio files (up to 16) to SD card or delete the SD card audio file in the client software.

Steps:

1. Insert the SD card into the master station.
2. On the remote configuration page, click **Alarm Management – Audio File** to enter the page.

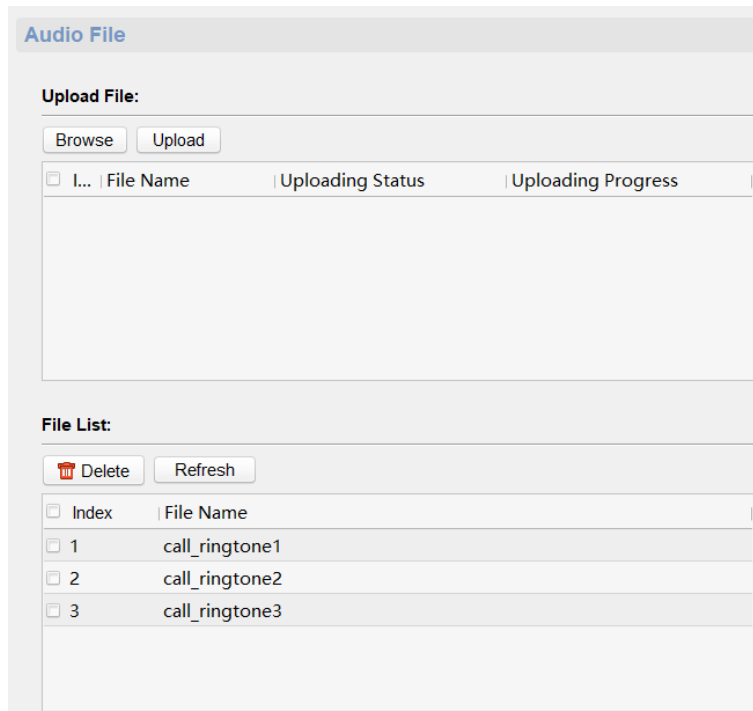

Figure 5-10 Audio File management

Uploading Audio File to MicroSD Card

Purpose:

In this section, you are able to upload custom audio files to SD card which has available storage space remotely.

Notes:

- Supported Audio file format: .mp3 and .wav. The file name can't contain spaces at the beginning and end. The length of the file name should be not more than 31, and the file name should not contain symbols: ?\/*"<>|.
- Each audio file size up to 2MB.
- An audio file will be overwritten if uploading an audio file with the same name.

Steps:

1. On the audio file page, click **Browse** to select the audio file (can be selected in batch).
2. Check the audio file in the Upload File list and click **Upload**.

Deleting the SD Card Audio File

Purpose:

In this section, you are able to delete audio files in SD card which has audio files.

Steps:

1. On the Audio File page, click **Refresh** to display the SD card audio file in the File List.
2. Check the audio file needs to be deleted, click **Delete**.

Notes:

- You can select and check audio file in batch.
- After the audio file is deleted, the function using this audio file will restore the default audio file configuration.

5.2.15 Configuring Camera parameters

Purpose:

In this section, you are able to configure the camera of the master station and the corresponding video standard.

Configuring Camera

On the remote configuration page, click **CCD - Video Parameters** to select the camera from the drop-down box. Click **Save** to save the setting.

Configuring Video Standard

Steps:

1. On the remote configuration page, click **Browse – Other** to enter the page.
2. Select the camera from the drop-down box.
3. Select **PAL (50HZ)** or **NTSC (60HZ)** from the Video Standard drop-down box.
4. Click **Save**.

Note: The video standard come into force after rebooting.

Appendix A Installation Notice

In order to reduce the impact of echo of the device, we recommend the distance between the two master stations should be no less than 10 m.

010000001090129

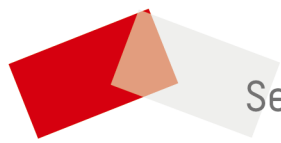

See Far, Go Further