

DS-MCW407(C) Android 4G Big Button Body Camera



- 1080p HD recording.
- IR function to recognize the facial features in the captured picture even in dim environment.
- Real-time status transmitted to central platform via 4G connection, which include GPS and live view.
- Built-in battery good for a full-shift work.
- Small size, lightweight, and convenient to carry.
- Large-button in the front for press-and-play recording.

▪ Specification

| Camera | |
|---------------------------|--|
| Image Sensor | 1/3" progressive scan CMOS |
| Max. Recording Resolution | 1920 × 1080 |
| Min. Illumination | Color: 0.11 Lux @ (F2.2, AGC ON), 0 Lux with supplement light |
| Day & Night | Switch IR cut filter automatically |
| Zoom | 4× Digital |
| White Light | 1 white light(s) |
| Lens | |
| Focal Length | 2.4 mm fixed lens |
| FOV | Horizontal FOV: 126°, Vertical FOV: 70°, Diagonal FOV: 144° |
| Aperture | F2.2 |
| Video | |
| Video Compression | H.264, H.265 |
| Video Format | MP4, PS |
| Main Stream | 60 Hz: 30 fps (1920 × 1080, 1280 × 720, 720 × 576) |
| Sub-Stream | 30 fps (1280 × 720, 720 × 576) |
| Pre-record & Post-record | Pre-record: 60 s, Post-record: 60 s |
| Audio | |
| Audio Compression | G.711ulaw, G.711alaw, G.722.1, AAC-LC |
| Audio Bit Rate | 64 Kbps (G.711ulaw/G.711alaw), 16 Kbps (G.711.1/AAC-LC) |
| Image | |
| Image Format | JPEG |
| Screen | |
| Display Resolution | 320 × 240 |
| Screen Size | 2.0" |
| Touchscreen | Supported |
| Storage | |
| RAM | 2 GB |
| ROM | 32 GB by default, 64/128/256 GB optional |
| IR | |
| IR Range | Up to 10 m |
| IR Wavelength | 850 nm |
| Wireless Network | |
| Bluetooth | BT4.2 |
| Wi-Fi Protocol | 802.11 a/b/g/n/ac |
| Wi-Fi Frequency Band | 2.412 to 2.472 GHz, 5.15 to 5.25 GHz, 5.725 to 5.875 GHz |
| Cellular Network | Only available for models with /GLE; GSM: 850/900/1800/1900, WCDMA: B1/B8, FDD -LTE: B1/B3/B4/B7/B20/B28, TDD -LTE: B34/B38/B39/B40/B41 |
| Positioning Mode | GPS |
| Network | |
| Protocol | HTTPS, RTSP, NTP, FTP |
| API | ONVIF (PROFILE S, PROFILE G, PROFILE T), ISAPI, SDK, ISUP |

| Interface | |
|---------------------|--|
| Indicator | 2 indicator(s) for charging/working/recording/exception |
| Button | Power, Video recording, Audio recording, Picture capture, PTT, SOS, Fn |
| Audio Type | 1 built-in mic(s), 1 speaker(s) |
| SIM Card | Only available for models with /GLE /5G; Nano-SIM card(s) |
| Charging Interface | Mini USB, Pin connection |
| USB | 1 USB 2.0 port(s) |
| General | |
| Operating Condition | -20 °C to 55 °C (-4 °F to 131 °F). Humidity 95% or less (non-condensing) |
| Power | 5 VDC, 2.0 A, max. 10 W |
| Dimensions | 82.6 mm × 58 mm × 29 mm (3.3" × 2.3" × 1.1") |
| Weight | 165 g (without mounting) (0.4 lb.) |
| Operating System | Android 9.0 |
| Client | HikCentral Pro,HikCentral Master |
| MIC | Supported |
| Speaker | 1 built-in speaker(s), max. power consumption: 1 W, max. sound pressure level: 87 dB (10 cm) |
| Battery | |
| Battery Type | Lithium-ion battery, integral |
| Capacity | 3220 mAh |
| Charging Time | ≤ 4 h |
| Battery Duration | Up to 12 h in 720p resolution ¹ |
| Approval | |
| RF | EN 300 328 V2.1.1 (BT or 2.4G), EN 62311: 2008 (BT or 2.4G), EN 55032: 2015, EN 61000-3-2: 2014, EN 61000-3-3: 2013, EN 50130-4: 2011+A1: 2014) |
| EMC | CE-EMC: EN 55032: 2015, EN 61000-3-2: 2019, EN 61000-3-3: 2013, EN 50130-4: 2011 +A1: 2014 |
| Safety | CB: IEC 62368-1: 2014+A11, IEC 62368-1: 2018, CE-LVD: EN 62368-1: 2014/A11: 2017, EN IEC 62368-1: 2020+A11: 2020, CE-LVD: EN 62368-1: 2014/A11: 2017 |
| Environment | CE-RoHS: 2011/65/EU, WEEE: 2012/19/EU, Reach: Regulation (EC) No 1907/2006 |
| Protection | IP68: IEC 60529-2013, MIL STD 810G |

This is a basic estimation of battery life only when recording is on. Additional power consumption should be considered when IR, GPS, and/or network connection is on.

▪ Available Model

DS-MCW407/32G/GLE(C)

DS-MCW407/32G/GLE(A)

▪ Dimension

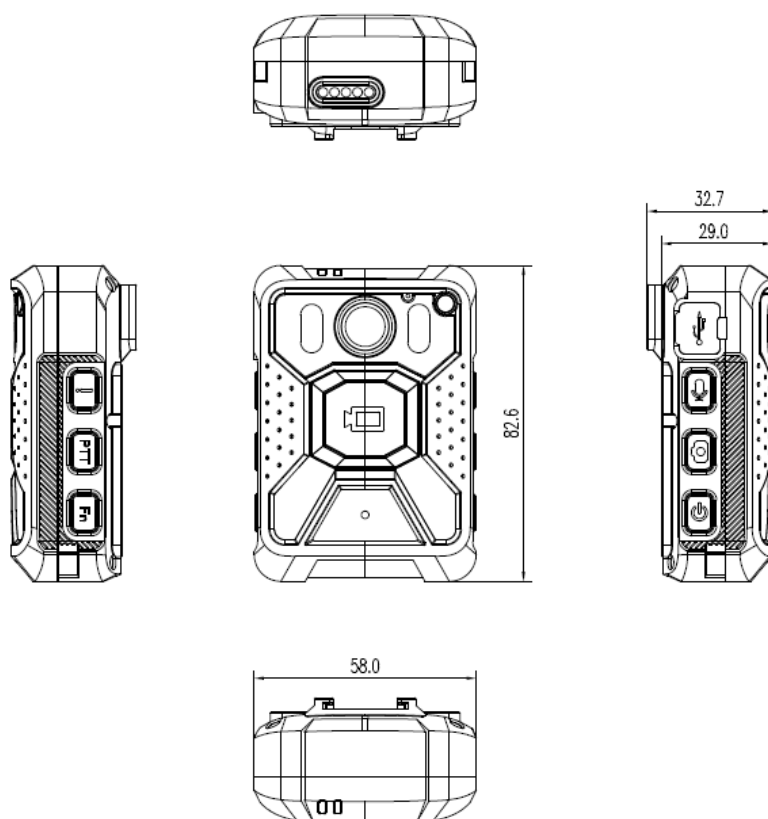





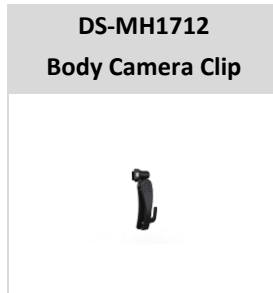





Unit: mm

- Accessory
- Included



▪ **Optional**

| | | | | |
|---|---|---|--|---|
| DS-MH1710-HM-S 22 Series Body Camera Metal Clip | DS-MH1711-HM Body Camera Chest Harness | DS-MH1721 Oblique shoulder Harness | DS-MH1411-B1 Body Camera Charge Cradle | DS-MH1714 Body Camera Clip-Fast Click |
|  |  |  |  |  |
| DS-MH1412-B1 6 Ports Body Camera Charge Cradle | DS-MH1310-B1 Body Camera Battery | DS-MH1712 Body Camera Clip | DS-MH1717 Body Camera 3-Magnetic Clip | DS-MH1716 Body Camera 3-Alligator clip |
|  |  |  |  |  |
| DS-MH1715 body camera 3-wearable clip | | | | |
|  | | | | |

Headquarters

No.555 Qianmo Road, Binjiang District,
Hangzhou 310051, China
T +86-571-8807-5998
www.hikvision.com



Follow us on social media to get the latest product and solution information.

