

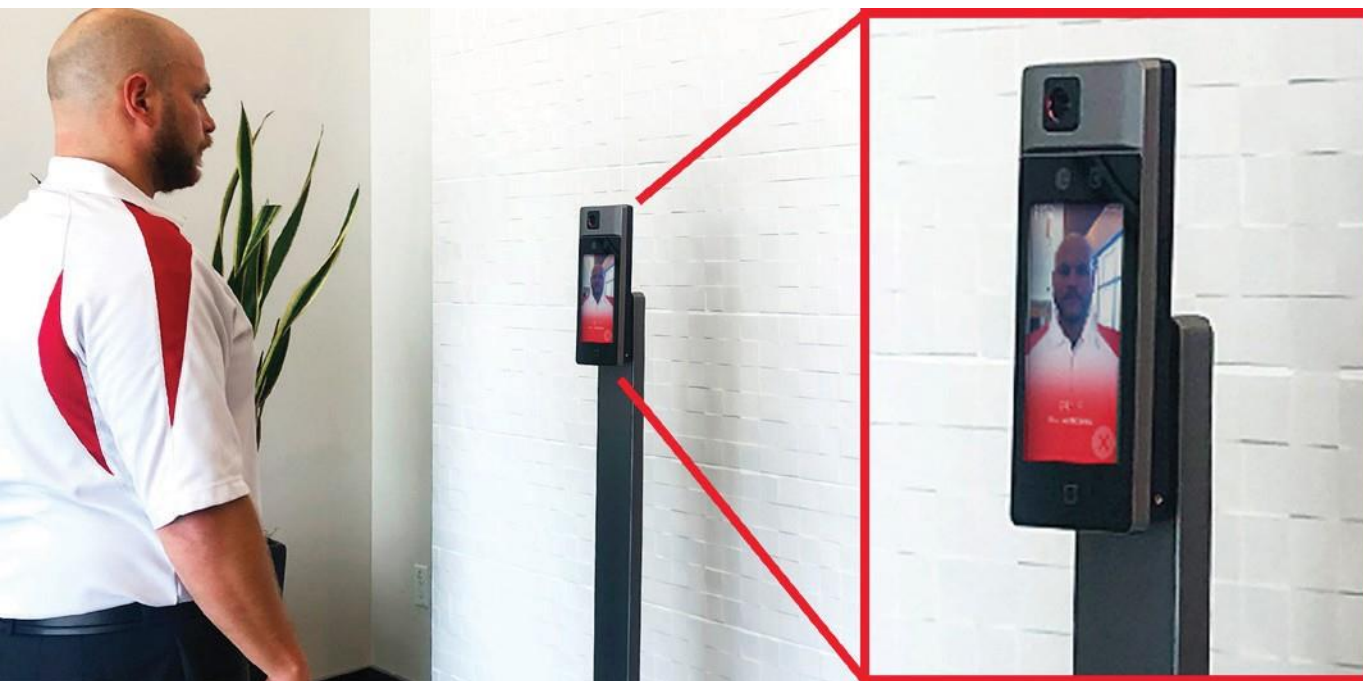

Temperature Screening Terminal with Mask Detection

Safe and Accurate Temperature Detection at the Door



ALERT AND AUDIBLE WARNING WHEN ABNORMAL TEMPERATURE HAS BEEN DETECTED

To safeguard employees, customers and visitors, many businesses are now screening for abnormal temperatures at entrances. Hikvision's highly accurate Temperature Screening Terminal includes advanced skin-surface temperature measurement, facial recognition access control, and mask detection, all in one solution. Our innovative access control terminal provides a safer, faster, and smarter solution that enables users to:

- Perform elevated skin-surface temperature screening with accuracy up to $\pm 0.9^{\circ}\text{F}$ ($\pm 0.5^{\circ}\text{C}$)
- View temperature results on local screen for quick identification
- No need to set permissions, normal temperature can unlock the door
- Detect the absence of face mask, triggers voice alarm using built-in speaker to request mask for entry

System

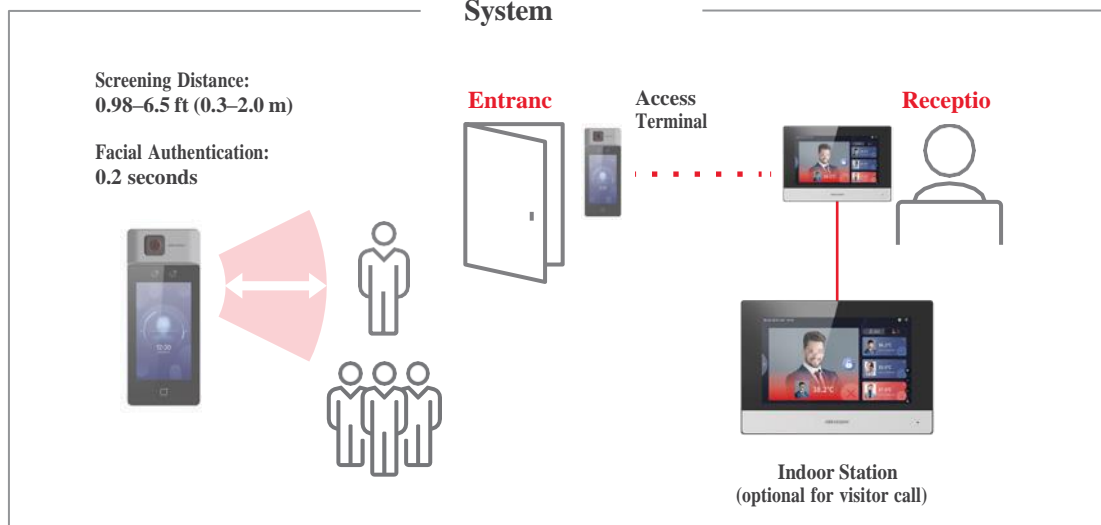

High Accuracy Temperature Screening, Access Control & Mask Detection



Hikvision's Temperature Screening Terminal DS-K1T671TM-3XF is an access control terminal integrated with high accuracy temperature screening and mask detection functions. It can quickly measure skin-surface temperature and display it on the 7-inch touch screen LCD. This product is ideal for office buildings, hospitals, hotels, transportation hubs, retailers, educational centers, and warehouses.

Our Temperature Screening Terminal supports multiple authentication modes including access control card with normal temperature and face detection with normal temperature. Both can be combined with the use of mask detection. During the temperature screening process, an audible warning will alert if no mask is detected and the person will be denied entrance until a mask is detected.



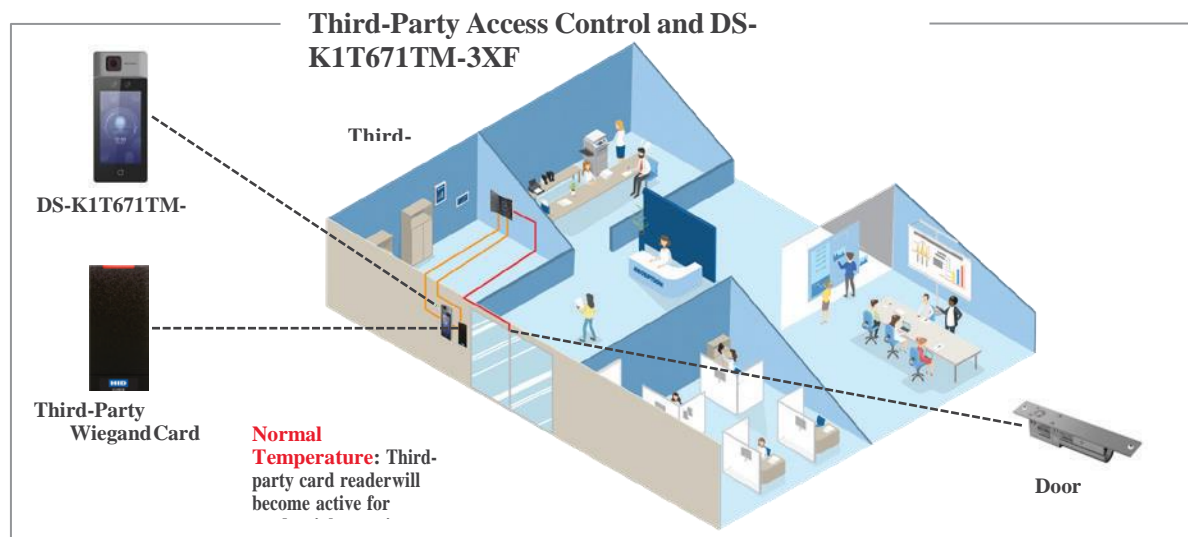

The terminal with facial recognition is also equipped with a 2 MP wide-angle, dual-lens, and anti-spoofing feature—where an individual cannot be granted access by holding up a photograph. It has the capacity to recognize up to 50,000 faces, 50,000 contactless cards, and store up to 100,000 events. Important access control interfaces include a lock relay, request to exit (REX), alarm I/O and a tamper alarm.



A large 7-inch LCD touch screen simplifies configuration and user interaction. Our terminal integrates with Hikvision NVRs for live view and playback.

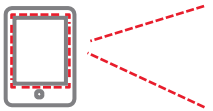
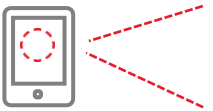

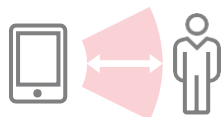
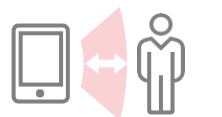
Key Benefits of Thermographic Technology

Hikvision offers key advantages with its thermographic technology. Most solutions are limited and can only measure temperature in a small area and have no facial recognition capability. The graphic below compares Hikvision technology benefits with a typical competitor.

Hikvision	Other
 <p>Full screen measurement</p>	 <p>Fixed limited area measurement</p>
 <p>Accurate Measurement & Tracking with Deep Learning Technology</p>	 <p>Measurement in the limited fixed area can be wrong or missed</p>
 <p>Measurement distance: 0.98 - 6.5 ft (0.3 - 2.0 m)</p>	 <p>Measurement distance: 0.98 - 1.6 ft (0.3 - 0.5 m)</p>
 <p>Efficiency: 0.2-second screening</p>	 <p>Efficiency: 5-second screening</p>

DS-KAB671-B (Optional)	DS-DM0701BL (Optional)	DS-KAB6-BASE (Optional)	DS-KP12V-3A (Optional)
			
<p>Versatile installation options: The DS-K1T671TM-3XF terminal can be placed near the entrance on the floor or on a desk with optional stands.</p>		<p>Mounting Base Plate for DS-KAB671-B</p>	<p>DC12V 3A Power Supply can be purchased separately</p>

Simplify Temperature Screening via Monitoring Tablet

Using our Video Intercom Monitoring Tablet DS-KC001 with our Temperature Screening Terminal simplifies monitoring of security and temperature. The tablet is equipped with a 7-Inch color touch screen LCD and a built-in 32 GB SD card that can record up to 100,000 temperature records and events. Abnormal temperature alarms and temperature records are sent to the monitoring tablet in real-time, allowing onsite personnel to quickly identify anyone with elevated skin-surface temperature and take immediate action to comply with guidelines.

Temperature Screening + Access Control + Video Surveillance = Versatile and Precise Monitoring Solution

Optional Monitoring Tablet Specification

DS-KC001	
	
<ul style="list-style-type: none">• 7-inch Touch Screen Android Monitoring Tablet• Display Resolution: 1024x600; Wi-Fi 802.11b/g/n• Remote Temperature Screening and Records Checking with Real-Time Preview• Centralized Data Management up to 100,000 Records• Built-in 32 GB SD card• Abnormal Temperature Alarm• Remote Access Control and Video Intercom• Power Adaptor Included	

Key features of combined screening terminal and monitoring tablet solution include:

- Thermographic Temperature Range: 86 to 113 Degrees Fahrenheit (30 to 45 Degrees Celsius)
- Accuracy: ± 0.9 Degrees Fahrenheit (± 0.5 Degrees Celsius)
- Smart—Only Screens Skin Surface of Forehead
- Temperature Measurement Distance: 0.98 to 6.5 ft (0.3 to 2.0 m)
- Temperature Measurement Height: 3.9 to 6.2 ft (1.2 to 1.9 m)
- Vanadium Oxide Uncooled Sensor Measures Temperature
- Rapid Temperature Measurement Mode: Detects Face, Takes Skin-Surface Temperature (without identity authentication)
- Triggers Voice Prompt when Abnormal Temperature Detected
- 7-Inch LCD Touch Screen for Easy Programming and Operation
- 2 MP Dual Wide-Angle Lens with WDR
- Face Mask Detection: If Mask is not Detected, Voice Reminder Prompt Sounds
- Face Mask Alert: Authentication Entrance Is Valid
- No Mask Alert: Authentication Entrance Not Allowed
- Capacity up to 50,000 Faces, 50,000 Cards and 100,000 Temperature and Event Records
- Supports Multiple Authentication Modes Including Card/Temperature, Face/Temperature, and Card/Face/Temperature.
- Prompt Alarm Live View and Intercom from iVMS-4200
- Displays Temperature Results in Local View and iVMS-4200
- Time Attendance Reports in iVMS-4200

Specifications



Mode 1		DS-K1T671TM-3XF
Operating System		Linux
Temperature Measurement	Sensor	Vanadium Oxide uncooled sensor
	Resolution	120 × 160
	Frame Rate	25 fps
	Temperature Range	86° F to 113° F (30° C to 45° C)
	Temperature Accuracy	±0.9° F (±0.5° C), without blackbody calibration
	Measuring Distance	0.98 to 6.5 ft (0.3 to 2.0 m)
Screen	Screen	7-inch touch screen
	Ratio	16:9
	Resolution	1024 x 600
Camera		2 MP dual-lens camera, WDR
Indicator		Supported
Face	Recognition Mode	Face: 1:1 and 1:N
	Face Capacity	50,000
	Face Recognition Duration	< 0.2 s per person
	Face Recognition Distance	0.98 to 6.5 ft (0.3 to 2.0 m)
Card	Card Capacity	50,000
	Card Type	M1 Card
	Card Swiping Duration	< 1 s
	Card Swiping Distance	0 to 2 in. (0 to 5 cm)
Event Capacity		100,000
Interface		1x Network, 1x RS-485, 1x Wiegand, 2x USB, 1x alarm output, 2x alarm input, 1x lock, 1x door contact, 1x exit button, 1x tamper
Network		10/100/1000 Mbps self-adaptive
Other	Operating Voltage	12V DC/2 A
	Operating Temperature	32° F to 122° F (0° C to 50° C) For temperature measurement: 50° F to 95° F (10° C to 35° C)
	Operating Humidity	10 to 90% (non-condensing)
	Application	Indoor
	Application Environment	Indoor and windless environment use only
	Bracket	Wall Mount (included), Floor Stand (DS-KAB671-B, purchase separately) Desk Stand (DS-DM0701BL, purchase separately)

**To prevent a fire hazard, equipment should not be exposed to direct sunlight, low ventilation or to a heat source such as heater or radiator.*

Product Dimensions

DS-K1T671MT-

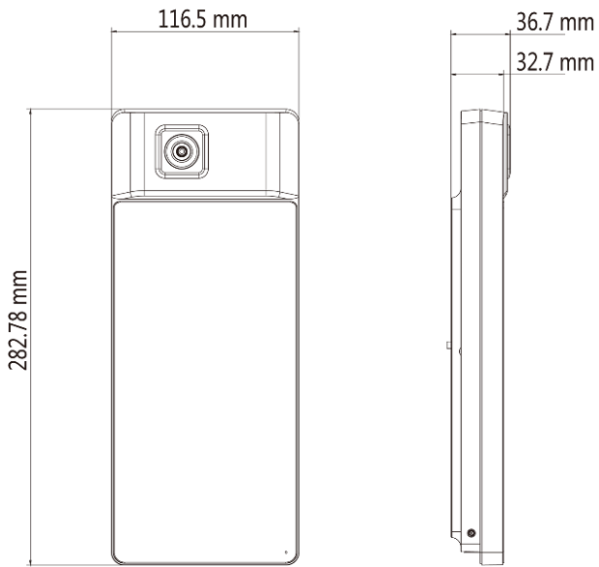

DS-KAB671-B (Optional)

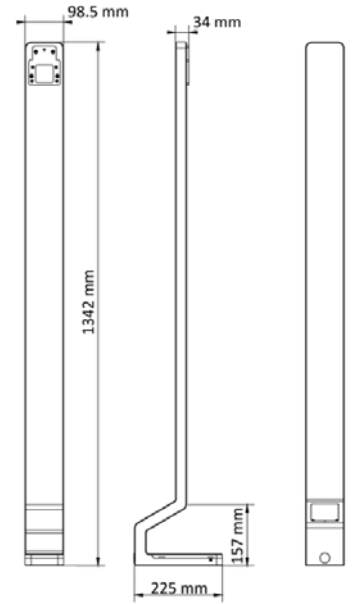

DS-DM0701BL (Optional)

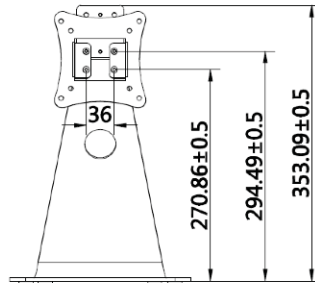
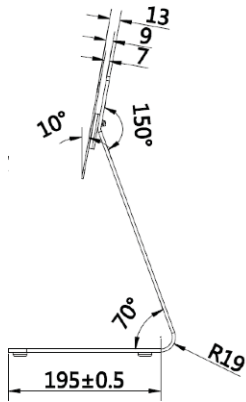

DS-KAB6-BASE (Optional)

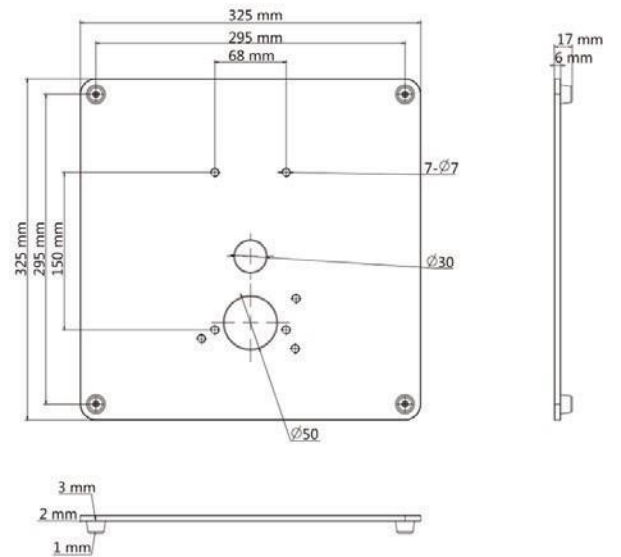

DS-KC001

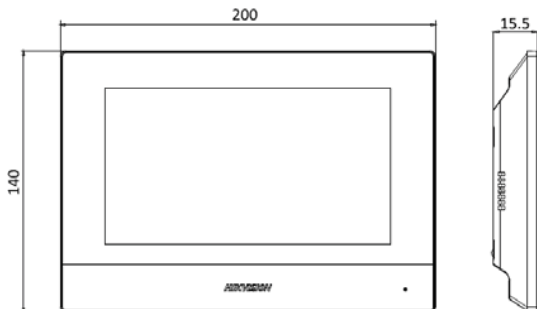

Unit : mm

Hikvision USA Inc.

18639 Railroad Street City
of Industry, CA 91748

Hikvision Canada Inc.

4848 Levy Street
Saint-Laurent, Quebec H4R 2P1

Contact Information

Toll-Free: +1 866-200-6690 (U.S. and Canada)
Phone: +1 909-895-0400
Email: sales.usa@hikvision.com

hikvision.com

Connect with us:     

©2020 Hikvision USA Inc. and Hikvision Canada Inc. All rights reserved. Hikvision is a registered trademark of Hikvision Digital Technology Co., Ltd. in the US, Canada and other countries. All other trademarks, service marks, and product or service names are trademarks or registered trademarks of their respective owners. Product specifications and availability are subject to change without Notice.
Disclaimer: Hikvision USA Inc. products depicted herein are not FDA approved medical devices and are not intended for use in the diagnosis of disease or other conditions, or in the cure, mitigation, treatment, or prevention of disease. When configured correctly, the Hikvision products discussed herein can identify elevated human skin-surface temperature relative to a sample population.