



**Handheld Thermal Binocular Camera**

**User Manual**

© 2019 Hangzhou Hikvision Digital Technology Co., Ltd. All rights reserved.

### **About this Manual**

The Manual includes instructions for using and managing the Product. Pictures, charts, images and all other information hereinafter are for description and explanation only. The information contained in the Manual is subject to change, without notice, due to firmware updates or other reasons. Please find the latest version of this Manual at the Hikvision website (<http://www.hikvision.com/>).

Please use this Manual with the guidance and assistance of professionals trained in supporting the Product.

### **Trademarks Acknowledgement**

- **HIKVISION** and other Hikvision's trademarks and logos are the properties of Hikvision in various jurisdictions.
- Other trademarks and logos mentioned are the properties of their respective owners.

### **LEGAL DISCLAIMER**

TO THE MAXIMUM EXTENT PERMITTED BY APPLICABLE LAW, THIS MANUAL AND THE PRODUCT DESCRIBED, WITH ITS HARDWARE, SOFTWARE AND FIRMWARE, ARE PROVIDED "AS IS" AND "WITH ALL FAULTS AND ERRORS". HIKVISION MAKES NO WARRANTIES, EXPRESS OR IMPLIED, INCLUDING WITHOUT LIMITATION, MERCHANTABILITY, SATISFACTORY QUALITY, OR FITNESS FOR A PARTICULAR PURPOSE. THE USE OF THE PRODUCT BY YOU IS AT YOUR OWN RISK. IN NO EVENT WILL HIKVISION BE LIABLE TO YOU FOR ANY SPECIAL, CONSEQUENTIAL, INCIDENTAL, OR INDIRECT DAMAGES, INCLUDING, AMONG OTHERS, DAMAGES FOR LOSS OF BUSINESS PROFITS, BUSINESS INTERRUPTION, OR LOSS OF DATA, CORRUPTION OF SYSTEMS, OR LOSS OF DOCUMENTATION, WHETHER BASED ON BREACH OF CONTRACT, TORT (INCLUDING NEGLIGENCE), PRODUCT LIABILITY, OR OTHERWISE, IN CONNECTION WITH THE USE OF THE PRODUCT, EVEN IF HIKVISION HAS BEEN ADVISED OF THE POSSIBILITY OF SUCH DAMAGES OR LOSS.

YOU ACKNOWLEDGE THAT THE NATURE OF INTERNET PROVIDES FOR INHERENT SECURITY RISKS, AND HIKVISION SHALL NOT TAKE ANY RESPONSIBILITIES FOR ABNORMAL OPERATION, PRIVACY LEAKAGE OR OTHER DAMAGES RESULTING FROM CYBER-ATTACK, HACKER ATTACK, VIRUS INSPECTION, OR OTHER INTERNET SECURITY RISKS; HOWEVER, HIKVISION WILL PROVIDE TIMELY TECHNICAL SUPPORT IF REQUIRED.

YOU AGREE TO USE THIS PRODUCT IN COMPLIANCE WITH ALL APPLICABLE LAWS, AND YOU ARE SOLELY RESPONSIBLE FOR ENSURING THAT YOUR USE CONFORMS TO THE APPLICABLE LAW. ESPECIALLY, YOU ARE RESPONSIBLE, FOR USING THIS PRODUCT IN A MANNER THAT DOES NOT INFRINGE ON THE RIGHTS OF THIRD PARTIES, INCLUDING WITHOUT LIMITATION, RIGHTS OF PUBLICITY, INTELLECTUAL PROPERTY RIGHTS, OR DATA PROTECTION AND OTHER PRIVACY RIGHTS. YOU SHALL NOT USE THIS PRODUCT FOR ANY PROHIBITED END-USES, INCLUDING THE DEVELOPMENT OR PRODUCTION OF WEAPONS OF MASS DESTRUCTION, THE DEVELOPMENT OR PRODUCTION OF CHEMICAL OR BIOLOGICAL WEAPONS, ANY ACTIVITIES IN THE CONTEXT RELATED TO ANY NUCLEAR EXPLOSIVE OR UNSAFE NUCLEAR FUEL-CYCLE, OR IN SUPPORT OF HUMAN RIGHTS ABUSES.

IN THE EVENT OF ANY CONFLICTS BETWEEN THIS MANUAL AND THE APPLICABLE LAW, THE LATER PREVAILS.

## **Regulatory Information**

### **FCC Information**

Please take attention that changes or modification not expressly approved by the party responsible for compliance could void the user's authority to operate the equipment.

**FCC compliance:** This equipment has been tested and found to comply with the limits for a Class B digital device, pursuant to part 15 of the FCC Rules. These limits are designed to provide reasonable protection against harmful interference in a residential installation. This equipment generates, uses and can radiate radio frequency energy and, if not installed and used in accordance with the instructions, may cause harmful interference to radio communications. However, there is no guarantee that interference will not occur in a particular installation. If this equipment does cause harmful interference to radio or television reception, which can be determined by turning the equipment off and on, the user is encouraged to try to correct the interference by one or more of the following measures:

- Reorient or relocate the receiving antenna.
- Increase the separation between the equipment and receiver.
- Connect the equipment into an outlet on a circuit different from that to which the receiver is connected.
- Consult the dealer or an experienced radio/TV technician for help.

This equipment should be installed and operated with a minimum distance 20cm between the radiator and your body.

### **FCC Conditions**

This device complies with part 15 of the FCC Rules. Operation is subject to the following two conditions:

1. This device may not cause harmful interference.
2. This device must accept any interference received, including interference that may cause undesired operation

### EU Conformity Statement



This product and, if applicable, the supplied accessories are marked with “CE” and comply therefore with the applicable harmonized European standards listed under the Radio Equipment Directive 2014/53/EU, the EMC Directive 2014/30/EU, the RoHS Directive 2011/65/EU.



2012/19/EU (WEEE directive): Products marked with this symbol cannot be disposed of as unsorted municipal waste in the European Union. For proper recycling, return this product to your local supplier upon the purchase of equivalent new equipment, or dispose of it at designated collection points. For more information see: [www.recyclethis.info](http://www.recyclethis.info).



2006/66/EC (battery directive): This product contains a battery that cannot be disposed of as unsorted municipal waste in the European Union. See the product documentation for specific battery information. The battery is marked with this symbol, which may include lettering to indicate cadmium (Cd), lead (Pb), or mercury (Hg). For proper recycling, return the battery to your supplier or to a designated collection point. For more information see: [www.recyclethis.info](http://www.recyclethis.info).

이 기기는 업무용 환경에서 사용할 목적으로 적합성평가를 받은 기기로서 가정용 환경에서 사용하는 경우 전파간섭의 우려가 있습니다.

### Symbol Convention

The symbols that may be found in this document are defined as follows.

Symbol	Description
NOTE	Provides additional information to emphasize or supplement important points of the main text.
WARNING	Indicates a potentially hazardous situation, which if not avoided, could result in equipment damage, data loss, performance degradation, or unexpected results.
DANGER	Indicates a hazard with a high level of risk, which if not avoided, will result in death or serious injury.

### Safety Instructions

These instructions are intended to ensure that user can use the product correctly to avoid danger or property loss.

### Laws and Regulations

- Use of the product must be in strict compliance with the local electrical safety regulations.

### **Transportation and Storage**

- Keep the device in original or similar packaging while transporting it.
- Keep all wrappers after unpacking them for future use. In case of any failure occurred, you need to return the device to the factory with the original wrapper. Transportation without the original wrapper may result in damage on the device and the company shall not take any responsibilities.
- Do not drop the product or subject it to physical shock. Keep the device away from magnetic interference.

### **Power Supply**

- Please use the power adapter, which is provided by normal company. Input voltage should meet the Limited Power Source (5 VDC, 2A) according to the IEC61010-1 standard. Please refer to technical specifications for detailed information.
- Make sure the plug is properly connected to the power socket.
- DO NOT connect multiple devices to one power adapter, to avoid over-heating or fire hazards caused by overload.

### **Battery**

- Improper use or replacement of the battery may result in explosion hazard. Replace with the same or equivalent type only. The battery type is 18650, and the rated voltage and capacity is 3.6 VDC/3.3 Ah (11.88Wh). Dispose of used batteries in conformance with the instructions provided by the battery manufacturer.
- Do not charge other battery types with the supplied charger. Confirm there is no flammable material within 2 m of the charger during charging.
- For long-term storage of the battery, make sure it is fully charged every half year to ensure the battery quality. Otherwise, damage may occur.
- DO NOT place the battery near heating or fire source. Avoid direct sunlight.
- DO NOT swallow the battery to avoid chemical burns.
- DO NOT place the battery in the reach of children.

### **Maintenance**

- Clean the lens with soft and dry cloth or wiping paper to avoid scratching it.
- Wipe the device gently with a clean cloth and a small quantity of ethanol, if necessary.
- If the product does not work properly, please contact your dealer or the nearest

service center. We shall not assume any responsibility for problems caused by unauthorized repair or maintenance.

- If the equipment is used in a manner not specified by the manufacturer, the protection provided by the device may be impaired.

### **Using Environment**

- DO NOT expose the device to extremely hot, cold, dusty, corrosive, saline-alkali, or damp environments. Make sure the running environment meets the requirement of the device. The operating temperature shall be -30 °C to 55 °C (-22 °F to 131 °F), and the operating humidity shall be 95% or less.
- This device can only be safely used in the region below 2000 meters above the sea level.
- Avoid equipment installation on vibratory surface or places subject to shock (neglect may cause equipment damage).
- Do not aim the lens at the sun or any other bright light.

### **Emergency**

- If smoke, odor, or noise arises from the device, immediately turn off the power, unplug the power cable, and contact the service center.

COMPLIANCE NOTICE: The thermal series products might be subject to export controls in various countries or regions, including without limitation, the United States, European Union, United Kingdom and/or other member countries of the Wassenaar Arrangement. Please consult your professional legal or compliance expert or local government authorities for any necessary export license requirements if you intend to transfer, export, re-export the thermal series products between different countries.

### **Manufacture Address**

No.555 Qianmo Road, Binjiang District, Hangzhou 310052, China  
Hangzhou Hikvision Digital Technology Co.,Ltd

### **User Manual of Electrical Version**

Scan the QR code to view the user manual on your mobile phone. Note that mobile data charges may apply if Wi-Fi is unavailable.



# Table of Contents

<b>1</b>	<b>Overview .....</b>	<b>1</b>
1.1	Device Description .....	1
1.2	Main Function .....	1
1.3	Appearance .....	2
1.3.1	Button .....	2
1.3.2	Interface .....	3
1.3.3	Cable .....	4
<b>2</b>	<b>Preparation .....</b>	<b>4</b>
2.1	Packaging List .....	4
2.2	Charge Device .....	5
2.3	Install Battery .....	6
2.4	Power On/Off .....	7
2.5	Menu Description .....	7
2.6	Cable Connection .....	8
<b>3</b>	<b>Image Settings .....</b>	<b>9</b>
3.1	Focus .....	9
3.2	Adjust Brightness .....	10
3.3	Adjust Contrast .....	10
3.4	Switch Mode .....	11
3.5	Set Palettes .....	11
3.6	Adjust Digital Zoom .....	12
3.7	Set OSD .....	12
3.8	Display Time .....	12
3.8.1	Synchronize Time .....	13
<b>4</b>	<b>Distance Measurement .....</b>	<b>13</b>
<b>5</b>	<b>GPS .....</b>	<b>14</b>
<b>6</b>	<b>Picture and Video .....</b>	<b>14</b>
6.1	Capture Picture .....	14
6.2	Record Video .....	14
6.3	View File .....	14
6.4	Export File .....	15
<b>7</b>	<b>T-Vision Connection .....</b>	<b>15</b>
<b>8</b>	<b>CVBS Output .....</b>	<b>16</b>
<b>9</b>	<b>Maintenance .....</b>	<b>16</b>
9.1	Restore Device .....	16
9.2	Upgrade Device .....	17
<b>10</b>	<b>Appendix .....</b>	<b>17</b>



10.1	Common Material Emissivity Reference .....	17
10.2	Device Command .....	18
10.3	Device Communication Matrix .....	18

# 1 Overview

## 1.1 Device Description

The handheld thermal binocular camera (*binoculars* for short) is a pair of binoculars with both thermal observation function and target searching function. In harsh conditions, such as in total dark or under extreme low illumination, you can observe the long-distance targets with the binoculars.

The binoculars are well-designed, and easily adopted for patrol and outdoor activities in the night.

## 1.2 Main Function

### **Distance Detection**

Device can detect the distance towards the target.

### **GPS Function**

The device can be located with GPS system.

### **Fusion**

Device can display fusion of thermal view and optical view.

### **Palette**

Device supports multiple palettes, and you can set the palette mode according to the scene.

### **Software Connection**

You can capture snapshots, record videos, and set parameters of the device via the client software.

## 1.3 Appearance

### 1.3.1 Button

The main keys of the binoculars are shown below.

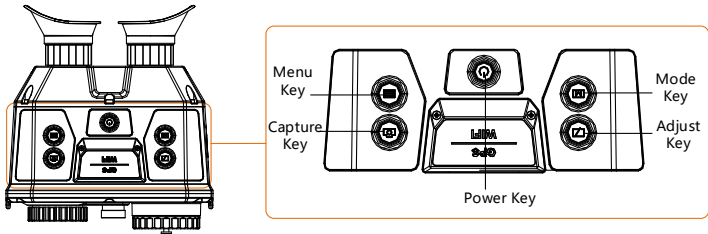

For the descriptions of the menu buttons, see the table below.

Button	Function
Adjust Key	Press the key to switch between <b>Near</b> , <b>Middle</b> , and <b>Far</b> in fusion mode. Hold the key to correct nonuniformity of display.
Mode Key	Press the key to switch the pallets. Hold the key to adjust the digit zoom.
Power Key	Press the key to emphasize the high-temperature target in the view in fusion mode. Hold the key to power on/off the device.
Capture Key	Press the key to capture the view. Hold the key to start/stop recording.
Menu Key	Press the key to switch between <b>White Hot</b> mode and <b>Black Hot</b> mode. Hold the key to enter the menu.

### 1.3.2 Interface

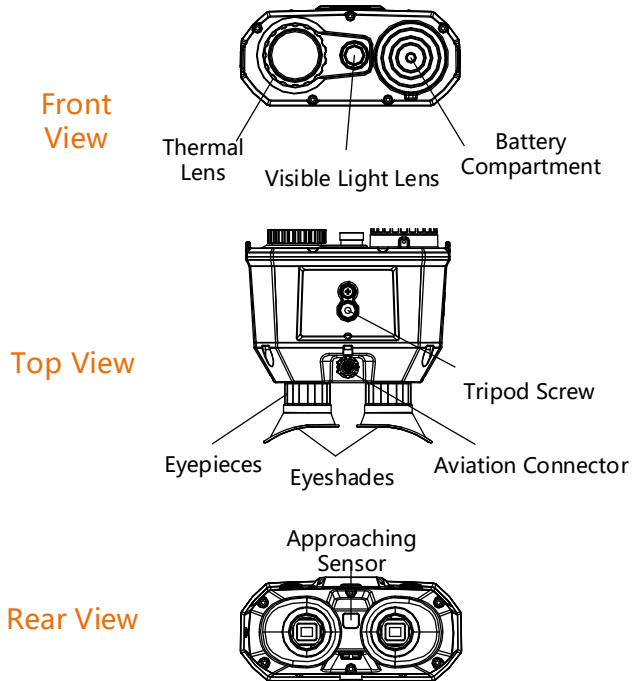

Interface	Function
Eyeshades	Cover the eyes.
Eyepieces	View from there.
Visible Light Lens	Let the visible light in.
Thermal Lens	Let the infrared light in.

Battery Compartment	The battery is here.
Tripod Screw	Install the binoculars on tripod.
Aviation Connector	Connect with the cables. See 1.3.3.
Approaching Sensor	Detect whether human eyes are approaching to save power. If it detected eyes, the OLED screen turns on, otherwise the OLED screen is off.

### 1.3.3 Cable

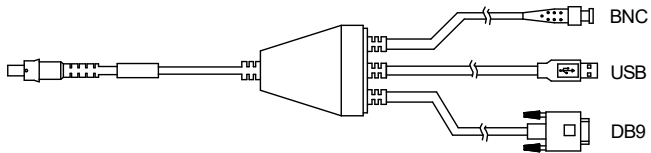

Cable	Function
BNC	Connect it to the display screen.
USB	Connect it to your PC to backup videos/images.
DB9	Reserved.

## 2 Preparation

### 2.1 Packaging List

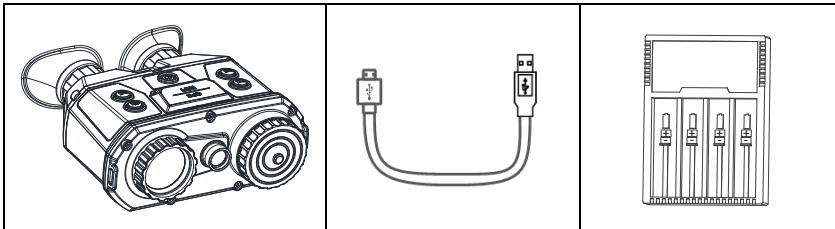

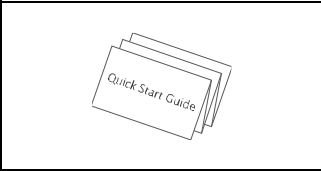
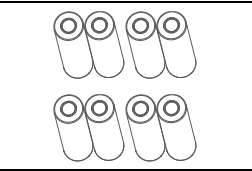
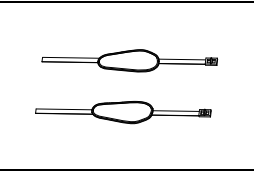
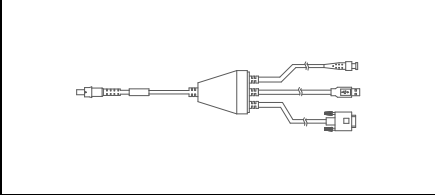
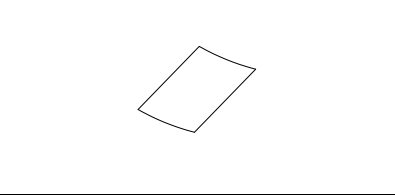
Thermal Binoculars (×1)	USB Cable (×1)	Battery Charger (×1)
		
Manual (×1)	Battery (×8)	Straps (×2)
		
Aviation Plug Cables (×1)	Non-dust Cloth (×1)	

## 2.2 Charge Device

### **Purpose:**

For the first use, and when the device is running low, charge the batteries with your charger.

### **Steps:**

1. Take out the USB cable from the package.
2. Connect the USB cable with battery charger and appropriate adaptor.
3. Insert the batteries in the charger with corresponding positive/negative terminals.

#### **NOTE**

When the charger is powered on, the LCD display automatically lights up, and all the battery. The charger will detect the battery and charge it.

Status	Description
Model & battery bars	Standby mode
Unlighted	Power-saving mode Press any button to activate it.
Err	Battery is damaged.
Blinking	Battery is being charged.

Chg.Finish	Battery is fully charged.
------------	---------------------------

4. Complete battery charging and disassemble the battery.

## 2.3 Install Battery

**Purpose:**

Insert the batteries into the battery compartment.

**Steps:**

1. Rotate the battery cover anticlockwise to disassemble it.

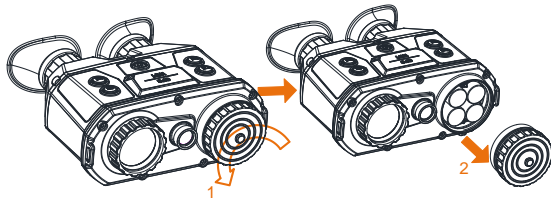

2. Insert four batteries with positive/negative marks match with that of the battery compartment

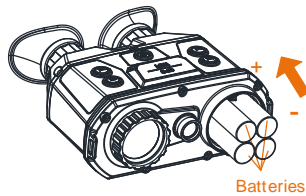

3. Align the shape of battery cover with that of the batteries and cover the batteries.
4. Rotate the battery cover clockwise to fix it.

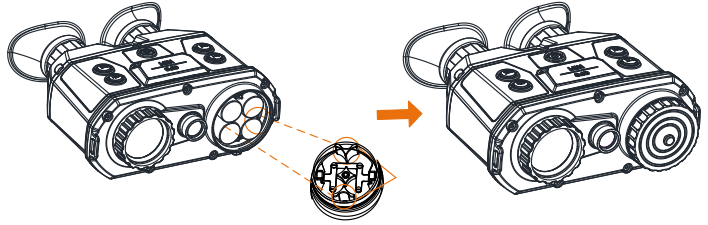



## 2.4 Power On/Off

When the binoculars is sufficiently charged, press the  key to power on the binoculars.

When the binoculars is running, hold the  key for four seconds to power off the binoculars.

 NOTE

- See the battery icon for the electricity quantity.  means battery is fully charged, and  means that the battery runs low.
- When the Low power note shows, charge the battery.

## 2.5 Menu Description

**Step:**

Hold the  button to show the menu.

In the menu, the direction keys, OK key, and the Exit key are shown below.

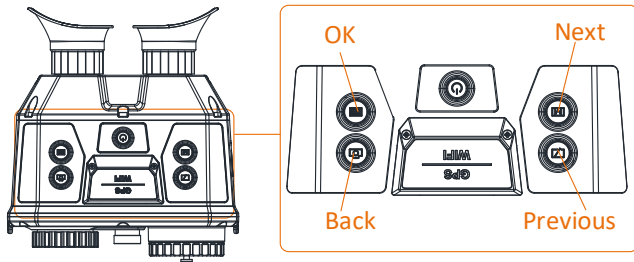

See the figure below for the menu interface.

 NOTE



The figure below is only for reference, the font size is readjusted for better viewing.



## 2.6 Cable Connection

- DO NOT drag the cables when you do the connecting, or when it is connected to the binoculars.
- To plug in/out the cable, hold the cable end and then plug in/out it. DO NOT twist the cables, or the pins inside may be damaged.

### **Purpose:**

Connect the binoculars with the aviation cable, and you can connect the device to your PC via USB interface or the display via the BNC interface.

### **Step:**

Connect the aviation cable with the aviation Interface. Make sure the anchor points match with each other and insert the cable. To disconnect the cable, lift the cable.

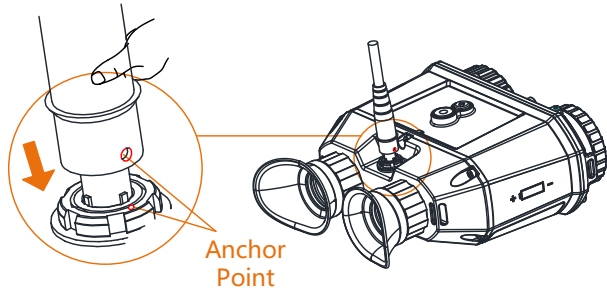

## 3 Image Settings

### 3.1 Focus



DO NOT touch the lens directly with your finger, or place any sharp objects near them.

**Steps:**

1. Slightly rotate the focus wheel to focus the objective lens.

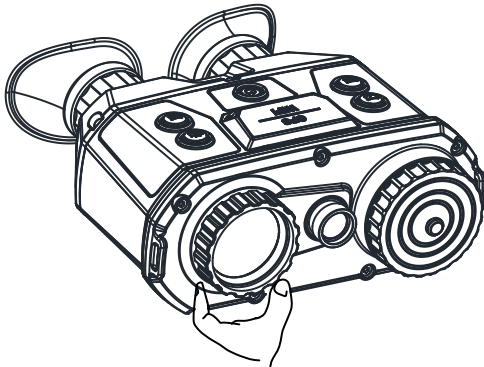



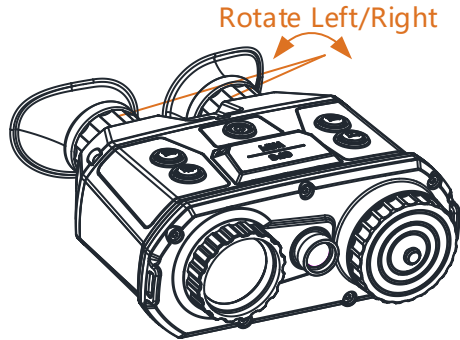





2. Slightly rotate the focus wheel to focus the objective lens.











## 3.2 Adjust Brightness

### Steps:

1. Hold the  key to show the menu of binoculars.
2. Press the  key and  key to move the cursor to **Display** submenu.
3. Press the  key to confirm.
4. Press the  key and  key to move the cursor to **Brightness** submenu.
5. Press the  key to confirm.
6. Press the  key and  key to set the brightness value. The higher, the brighter.

## 3.3 Adjust Contrast

### Steps:







1. Hold the  key to show the menu of binoculars.
2. Press the  key and  key to move the cursor to **Display** submenu.
3. Press the  key to confirm.
4. Press the  key and  key to move the cursor to **Contrast** submenu.
5. Press the  key to confirm.
6. Press the  key and  key to set the contrast value. The higher, the more contrasting.

## 3.4 Switch Mode

**Purpose:**

The change of environment temperature will affect the display effect. You can switch the mode between **Winter** and **Summer** to get a better view.



**Steps:**

1. Hold the  key to show the menu of binocular.
2. Press the  key and  key to move the cursor to **Display** submenu.
3. Press the  key to confirm.
4. Press the  key and  key to move the cursor to **Mode** submenu.



NOTE

The submenu is not displayed in **Visible** mode.



5. Press the  key to switch mode between winter and summer.
6. Press the  key to save and exit.

## 3.5 Set Palettes

**Purpose:**

The binoculars has dual-lens: thermal and visible light lens. You can set the thermal/optical view to show thermal channel, visible light channel, or both them combined. For thermal view, you can set the palettes.

**Step:**

1. In the live view interface, press the  key to display the palettes menu.
2. Press the  key to switch the view mode.

Mode	Description
Thermal	In thermal mode, the device displays the thermal view. Press the  key to switch between white hot and black hot mode.
Visible	In visible mode, the device displays the view of visible light channel.
Fusion B/W	It displays the combined view of thermal channel and optical channel in black and white.
City	Applicable to city environment.
Jungle	Applicable to jungle environment.

Desert	Applicable to desert environment.
Sea	Applicable to sea environment.
Snow	Applicable to snow environment.

**Result:**

After setting the palette, the current palette, next palette, and the previous palette are shown in the upper right corner.









### 3.6 Adjust Digital Zoom

Hold the  key to switch the digital zoom of binoculars. The value of digital zoom can be set to 1X, 2X, 4X.







### 3.7 Set OSD

**Steps:**

1. Hold the  key to show the menu of binoculars.
2. Press the  key and  key to move the cursor to **Settings** submenu.
3. Press the  key to confirm.
4. Press the  key and  key to move the cursor to **OSD** submenu.
5. Press the  key to switch on/off OSD.

















### 3.8 Display Time

**Steps:**

1. Hold the  key to show the menu of binoculars.
2. Press the  key and  key to move the cursor to **Settings** submenu.
3. Press the  key to confirm.
4. Press the  key and  key to move the cursor to **Time** submenu.
5. Press the  key to switch on/off time display.

### 3.8.1 Synchronize Time

**Steps:**

1. Hold the  key to show the menu of binocular.
2. Press the  key and  key to move the cursor to **Settings** submenu.
3. Press the  key to confirm.
4. Press the  key and  key to move the cursor to **Time Sync** submenu.
5. Press the  key to confirm.
6. Press the  key and  key to move the cursor to **24-Hour Time**.
7. Press the  key to enable or disable 24-Hour time display.
8. Press the  key and  key to move the cursor to date or time setting position.
9. Press the  key to confirm.
10. Press the  key and  key to adjust the value, and press the  key to confirm.

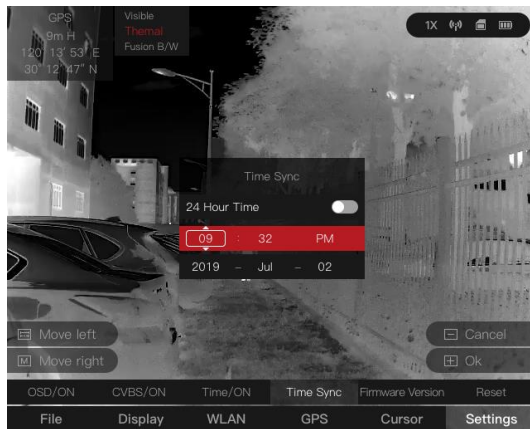





## 4 Distance Measurement

**Purpose:**

Display the cursor on the live view, and the distance towards the target can be measured.

**Steps:**





1. Hold the  key to show the menu of binoculars.
2. Press the  key and  key to move the cursor to **Cursor** submenu.
3. Press the  key to confirm.
4. Manually move the binoculars, align the horizontal line with the target bottom and measure the distance to the target.
5. Hold the  key to exit.



To disable the cursor, go to **Cursor** submenu and press the  key.

## 5 GPS

**Steps:**

1. Hold the  key to show the menu of binoculars.
2. Press the  key and  key to move the cursor to **GPS** submenu.
3. Press the  key to switch ON or OFF.



## 6 Picture and Video

### 6.1 Capture Picture

In the live view mode, press the  key to capture a snapshot.  
When capturing succeeded, it shows **Capture succeeded**.  
When capturing failed, it shows **Capture failed**.

### 6.2 Record Video







**Steps:**

1. In the live view mode, hold the  key to record videos.  
When the recording time shows on the top, it starts to record.
2. When the desired video is recorded, hold the  key to stop recording.

### 6.3 View File

**Steps:**

1. Hold the  key to show the menu of binoculars.

2. Press the  key and  key to move the cursor to **File>Image** or **File>Video** submenu.
3. Press the  key to confirm.
4. Press the  key and  key to select file.
5. Press the  key to view the selected file. Hold the  key to delete the selected file.



You can also delete the snapshot while viewing the live view.

## 6.4 Export File

### ***Before you start:***

Connect the binoculars to your PC via USB interface of the aviation plug. Refer to Section **3.1**.

### ***Purpose:***

Export the videos and snapshots with your PC.

### ***Steps:***

1. In your PC, go to the **Removable Disk**.
2. Double-click to open the disk. View or copy the videos or snapshots.
3. Disconnect the binoculars with the PC.

## 7 T-Vision Connection







### ***Before you start:***

Install the T-Vision software on your mobile phone first, and then connect your phone to the hot spot of the binocular.

### ***Purpose:***

You can configure the parameters, capture pictures, or record videos of the device via the software.

### ***Steps:***

1. Hold the  key to show the menu of binoculars.
2. Press the  key and  key to move the cursor to **WLAN** submenu.
3. Press the  key to confirm.
4. Press the  key and  key to move the cursor to **Hot Spot** submenu.
5. Press the  key to confirm.
6. Turn on the WLAN of your phone and connect to the hot spot.



- Hot Spot Name: HIK-IPTS Serial No.
  - Hot Spot Password: Serial No.
7. Search the “T-Vision” on App Store (iOS System) or Google Play™ (Android System), or scan the QR code to download and install the app.



Android System



iOS System

8. Open the APP and connect your phone with the device. You can view the interface of binoculars on your phone.

## 8 CVBS Output







### **Before you start:**

Connect the binoculars to the display unit via CVBS interface of the aviation plug. Refer to Section 3.1.

### **Purpose:**

View the binoculars image on the display unit for details.

### **Steps:**

1. Hold the  key to show the menu of binoculars.
2. Press the  key and  key to move the cursor and open **Settings** submenu.
3. Press the  key and  key to move the cursor and open **CVBS ON/OFF** submenu.
4. Press the  key to switch on CVBS.







## 9 Maintenance

### 9.1 Restore Device

#### **Purpose:**

Restore the device to default settings.

#### **Steps:**

1. Hold the  key to show the menu of binoculars.
2. Press the  key and  key to move the cursor to **Settings** submenu.
3. Press the  key to confirm.
4. Press the  key and  key to move the cursor to **Reset** submenu.
5. Press the  key to confirm.

 **NOTE**

After restoring, the device reboots automatically. You need to activate the device again.

## 9.2 Upgrade Device

**Steps:**

1. Connect the device to your PC with cable and open the detected disk.
2. Copy the upgrade file and paste it to the root directory of the device.
3. Disconnect the device from your PC.
4. Reboot the device and then it will upgrade automatically. The upgrading process will be displayed in the main interface.

 **NOTE**

After the upgrading, the device automatically reboot. You can view the current version in **Settings > Firmware Version**.

# 10 Appendix

## 10.1 Common Material Emissivity Reference

Material	Emissivity
Human Skin	0.98
PCB	0.91
Cement Concrete	0.95

Ceramics	0.92
Rubber	0.95
Paint	0.93
Wood	0.85
Asphalt	0.96
Brick	0.95
Sand	0.90
Soil	0.92
Cotton	0.98
Cardboard	0.90
White Paper	0.90
Water	0.96

## 10.2 Device Command

Scan the following QR code to get device common serial port commands.

Note that the command list contains the commonly used serial port commands for Hikvision thermal cameras.



## 10.3 Device Communication Matrix

Scan the following QR code to get device communication matrix.

Note that the matrix contains all communication ports of Hikvision thermal cameras.





See Far, Go Further