



Explosion-Proof Optical & Thermal
Network Bullet Camera
Quick Start Guide



©2023 Hangzhou Hikvision Digital Technology Co., Ltd. All rights reserved.

About this Manual

The Manual includes instructions for using and managing the Product. Pictures, charts, images and all other information hereinafter are for description and explanation only. The information contained in the Manual is subject to change, without notice, due to firmware updates or other reasons. Please find the latest version of this Manual at the Hikvision website (<https://www.hikvision.com/>).

Please use this Manual with the guidance and assistance of professionals trained in supporting the Product.

Trademarks Acknowledgement

- **HIKVISION** and other Hikvision's trademarks and logos are the properties of Hikvision in various jurisdictions.
- Other trademarks and logos mentioned are the properties of their respective owners.

LEGAL DISCLAIMER

TO THE MAXIMUM EXTENT PERMITTED BY APPLICABLE LAW, THIS MANUAL AND THE PRODUCT DESCRIBED, WITH ITS HARDWARE, SOFTWARE AND FIRMWARE, ARE PROVIDED "AS IS" AND "WITH ALL FAULTS AND ERRORS". HIKVISION MAKES NO WARRANTIES, EXPRESS OR IMPLIED, INCLUDING WITHOUT LIMITATION, MERCHANTABILITY, SATISFACTORY QUALITY, OR FITNESS FOR A PARTICULAR PURPOSE. THE USE OF THE PRODUCT BY YOU IS AT YOUR OWN RISK. IN NO EVENT WILL HIKVISION BE LIABLE TO YOU FOR ANY SPECIAL, CONSEQUENTIAL, INCIDENTAL, OR INDIRECT DAMAGES, INCLUDING, AMONG OTHERS, DAMAGES FOR LOSS OF BUSINESS PROFITS,



BUSINESS INTERRUPTION, OR LOSS OF DATA, CORRUPTION OF SYSTEMS, OR LOSS OF DOCUMENTATION, WHETHER BASED ON BREACH OF CONTRACT, TORT (INCLUDING NEGLIGENCE), PRODUCT LIABILITY, OR OTHERWISE, IN CONNECTION WITH THE USE OF THE PRODUCT, EVEN IF HIKVISION HAS BEEN ADVISED OF THE POSSIBILITY OF SUCH DAMAGES OR LOSS.

YOU ACKNOWLEDGE THAT THE NATURE OF THE INTERNET PROVIDES FOR INHERENT SECURITY RISKS, AND HIKVISION SHALL NOT TAKE ANY RESPONSIBILITIES FOR ABNORMAL OPERATION, PRIVACY LEAKAGE OR OTHER DAMAGES RESULTING FROM CYBER-ATTACK, HACKER ATTACK, VIRUS INFECTION, OR OTHER INTERNET SECURITY RISKS; HOWEVER, HIKVISION WILL PROVIDE TIMELY TECHNICAL SUPPORT IF REQUIRED.

YOU AGREE TO USE THIS PRODUCT IN COMPLIANCE WITH ALL APPLICABLE LAWS, AND YOU ARE SOLELY RESPONSIBLE FOR ENSURING THAT YOUR USE CONFORMS TO THE APPLICABLE LAW. ESPECIALLY, YOU ARE RESPONSIBLE, FOR USING THIS PRODUCT IN A MANNER THAT DOES NOT INFRINGE ON THE RIGHTS OF THIRD PARTIES, INCLUDING WITHOUT LIMITATION, RIGHTS OF PUBLICITY, INTELLECTUAL PROPERTY RIGHTS, OR DATA PROTECTION AND OTHER PRIVACY RIGHTS. YOU SHALL NOT USE THIS PRODUCT FOR ANY PROHIBITED END-USES, INCLUDING THE DEVELOPMENT OR PRODUCTION OF WEAPONS OF MASS DESTRUCTION, THE DEVELOPMENT OR PRODUCTION OF CHEMICAL OR BIOLOGICAL WEAPONS, ANY ACTIVITIES IN THE CONTEXT RELATED TO ANY NUCLEAR EXPLOSIVE OR UNSAFE NUCLEAR FUEL-CYCLE, OR IN SUPPORT OF HUMAN RIGHTS ABUSES.



IN THE EVENT OF ANY CONFLICTS BETWEEN THIS MANUAL AND THE APPLICABLE LAW, THE LATTER PREVAILS.



These clauses apply only to the products bearing the corresponding mark or information.

EU Conformity Statement



This product and - if applicable - the supplied accessories too are marked with "CE" and comply therefore with the applicable harmonized European standards listed under the EMC Directive 2014/30/EU, the LVD



Directive 2014/35/EU, the RoHS Directive 2011/65/EU, the ATEX Directive 2014/34/EU.

This product and - if applicable - the supplied accessories too are marked with "UKCA" and comply therefore with the following directives: Electromagnetic Compatibility Regulations 2016, Electrical Equipment (Safety) Regulations 2016, the Restriction of the Use of Certain Hazardous Substances in Electrical and Electronic Equipment Regulations 2012.



2012/19/EU (WEEE directive): Products marked with this symbol cannot be disposed of as unsorted municipal waste in the European Union. For proper recycling, return this product to your local supplier upon the purchase of equivalent new equipment, or dispose of it at designated collection points. For more information see: www.recyclethis.info

According to the Waste Electrical and Electronic Equipment Regulations 2013: Products marked with this symbol cannot be disposed of as unsorted municipal waste in the United Kingdom. For proper recycling, return this product to your local supplier upon the

purchase of equivalent new equipment, or dispose of it at designated collection points. For more information see: www.recyclethis.info.

Intended use of the camera

ATEX:  II 2 G Ex db IIC T6 Gb

 II 2 D Ex tb IIIC T80°C Db

IECEX: Ex db IIC T6 Gb/ Ex tb IIIC T80 °C Db

Hazardous Area Classification: Zone 1, Zone 2, Zone 21, Zone 22.

IP Degree: IP66/IP68 (2 m, 2 h)

Ex Standards:

IEC 60079-0: 2017 EN 60079-0: 2018

IEC 60079-1: 2014 EN 60079-1: 2014

IEC 60079-31: 2013 EN 60079-31: 2014

Nameplate:

Explosion-Proof Optical & Thermal Network Bullet Camera		
Product Model: _____   TÜV 22 UKEX 7123 X TÜV 21 ATEX 8737 X Ex db IIC T6 Gb IECEx TUR 21.0057 X  II 2 G Ex db IIC T6 Gb Ex tb IIIC T80°C Db  II 2 D Ex tb IIIC T80°C Db Environment Temperature: -40 °C to 60 °C Protection Level: IP66/IP68 (2m/2h) Working Voltage: AC100 to 240V; POE:DC36 to 57V Rated Power: ≤ 8 W Product No.: _____ Date of Production: _____ Hangzhou Hikvision Digital Technology Co., Ltd. 555 Qianmo Road, Binjiang District, Hangzhou, China	WARNING: DO NOT OPEN WHEN AN EXPLOSIVE ATMOSPHERE IS PRESENT	
	CAUTION: USE FASTENERS WITH YIELD STRESS ≥ 450MPa	



Special Conditions for Safe Use:

1. Under certain extreme dust circumstances, the coating film on the enclosure of this equipment may generate an ignition-capable level of electrostatic charge. Therefore the equipment shall not be installed in a location where the external conditions are conducive to the build-up of electrostatic charge on such surfaces. In addition, the equipment shall only be cleaned with a damp cloth.
2. Specific guidance noted to contact the original manufacturer for information on the dimension of the flameproof joints.
3. The fasteners of window cover shall only be replaced with the identical part No. SC-HSCSM6X15L11-SUS316L-DAC.

Industry Canada ICES-003 Compliance

This device meets the CAN ICES-003 (A)/NMB-003(A) standards requirements.

Warning:

This is a class A product. In a domestic environment this product may cause radio interference in which case the user may be required to take adequate measures.



KC

A 급 기기: 이 기기는 업무용(A 급) 전자파적합기기로서 판매자 또는 사용자는 이 점을 주의하시기바라며, 가정 외의 지역에서 사용하는 것을 목적으로 합니다.

Symbol Conventions

The symbols that may be found in this document are defined as follows.



Symbol	Description
	Indicates a hazardous situation which, if not avoided, will or could result in death or serious injury.
	Indicates a potentially hazardous situation which, if not avoided, could result in equipment damage, data loss, performance degradation, or unexpected results.
	Provides additional information to emphasize or supplement important points of the main text.

Safety Instruction

These instructions are intended to ensure that user can use the product correctly to avoid danger or property loss.

Laws and Regulations

- In the use of the product, you must be in strict compliance with the electrical safety regulations of the nation and region.

Transportation

- Keep the device in original or similar packaging while transporting it.
- Keep all wrappers after unpacking them for future use. In case of any failure occurred, you need to return the device to the factory with the original wrapper. Transportation without the original wrapper may result in damage on the device and the company shall not take any responsibilities.



- DO NOT drop the product or subject it to physical shock. Keep the device away from magnetic interference.

Power Supply

- Input voltage should meet the Limited Power Source (100 to 240 VAC) according to the IEC62368 standard. Please refer to technical specifications for detailed information.
- Make sure the plug is properly connected to the power socket.
- The socket-outlet shall be installed near the equipment and shall be easily accessible.
- DO NOT connect multiple devices to one power adapter, to avoid over-heating or fire hazards caused by overload.
- DO NOT touch the bare metal contacts of the inlets after the circuit breaker is turned off. Electricity still exists.
- + identifies the positive terminal(s) of equipment which is used with, or generates direct current. - identifies the negative terminal(s) of equipment which is used with, or generates direct current.
- The equipment must be connected to an earthed mains socket-outlet.
- A readily accessible disconnect device shall be incorporated external to the equipment.
- An all-pole mains switch shall be incorporated in the electrical installation of the building.
- Ensure correct wiring of the terminals for connection to an AC mains supply.
- The equipment has been designed, when required, modified for connection to an IT power distribution system.



- Use the power adapter provided by qualified manufacturer. Refer to the product specification for detailed power requirements.

Installation

- Never place the equipment in an unstable location. The equipment may fall, causing serious personal injury or death.
- This equipment is for use only with corresponding brackets. Use with other (carts, stands, or carriers) may result in instability causing injury.

System Security

- You acknowledge that the nature of Internet provides for inherent security risks, and our company shall not take any responsibilities for abnormal operation, privacy leakage or other damages resulting from cyber attack, hacker attack, however, our company will provide timely technical support if required.
- Please enforce the protection for the personal information and the data security as the device may be confronted with the network security problems when it is connected to the Internet. Please contact us when the device might exist network security risks.
- Please understand that you have the responsibility to configure all the passwords and other security settings about the device, and keep your user name and password.

Maintenance

- If the product does not work properly, please contact your dealer



or the nearest service center. We shall not assume any responsibility for problems caused by unauthorized repair or maintenance.

- A few device components (e.g. electrolytic capacitor) require regular replacement. The average lifespan varies, so periodic checking is recommended. Contact your dealer for details.
- Wipe the device gently with a clean cloth and a small quantity of ethanol, if necessary.
- If the equipment is used in a manner not specified by the manufacturer, the protection provided by the device may be impaired.
- To reduce the risk of fire, replace only with the same type and rating of fuse.
- The serial port of the equipment is used for debugging only.

Using Environment

- Make sure the running environment meets the requirement of the device. The operating temperature shall be $-40\text{ }^{\circ}\text{C}$ to $60\text{ }^{\circ}\text{C}$ ($-40\text{ }^{\circ}\text{F}$ to $140\text{ }^{\circ}\text{F}$), the maximum altitude to use the equipment is 5000 m, and the operating humidity shall be 95% or less, no condensing.
- DO NOT expose the device to high electromagnetic radiation or dusty environments.
- DO NOT aim the lens at the sun or any other bright light.
- The equipment shall not be exposed to dripping or splashing and that no objects filled with liquids, such as vases, shall be placed on the equipment.
- No naked flame sources, such as lighted candles, should be



placed on the equipment.

- Provide a surge suppressor at the inlet opening of the equipment under special conditions such as the mountain top, iron tower, and forest.
- Burned fingers when handling the parts with symbol . Wait one-half hour after switching off before handling the parts.

Emergency

- If smoke, odor, or noise arises from the device, immediately turn off the power, unplug the power cable, and contact the service center.

Manufacture Address

No.555 Qianmo Road, Binjiang District, Hangzhou 310052, China
Hangzhou Hikvision Digital Technology Co.,Ltd.

COMPLIANCE NOTICE: The thermal series products might be subject to export controls in various countries or regions, including without limitation, the United States, European Union, United Kingdom and/or other member countries of the Wassenaar Arrangement. Please consult your professional legal or compliance expert or local government authorities for any necessary export license requirements if you intend to transfer, export, re-export the thermal series products between different countries.



Table of Contents

1 Introduction	2
1.1 Overview	2
1.2 Model Description	2
2 Appearance Description	5
2.1 Camera Overview	5
2.2 Cable Description	6
3 Installation	8
3.1 Camera Installation.....	8
3.2 Terminal Box Installation	13
4 Setting the Network Camera over the LAN	14
4.1 Wiring.....	14
4.2 Activating the Camera	15
4.2.1 Activation via Web Browser	15
4.2.2 Activation via SADP Software.....	16
4.3 Modifying the IP Address.....	18
5 Accessing via Web Browser	22
6 Operating via Hik-Connect App	24
6.1 Enable Hik-Connect Service on Camera	24
6.1.1 Enable Hik-Connect Service via SADP Software	24
6.1.2 Enable Hik-Connect Service via Web Browser.....	25
6.2 Hik-Connect Setup	27
6.3 Adding Camera to Hik-Connect.....	27
6.4 Initializing the Memory Card	29



1 Introduction

1.1 Overview

Explosion-proof network camera is a video security product capable of video/audio collecting, smart encoding and network transmitting. It adopts an embedded system and a high-performed hardware process platform to achieve good stability and reliability.

You can visit and configure your camera via web browser and client software.

Explosion-proof network camera adopts a stainless steel enclosure, receiving an IP68 rating for ingress protection.

Application Scenarios: oil industry, mine fields, chemical industry, port, grain processing industry, etc.

1.2 Model Description

Explanation of model naming:

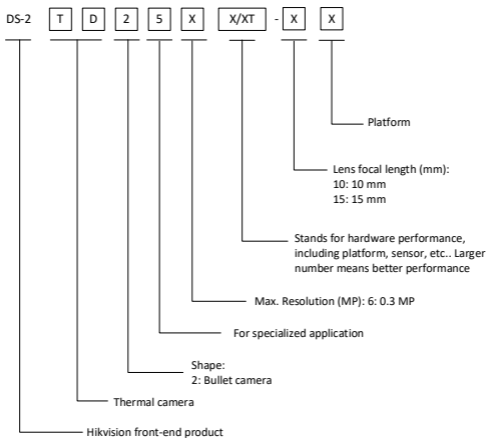

Figure 1-1 Model Explanation

Table 1-1 Naming Rule

Explosion-Proof Optical & Thermal Network Bullet Camera		
①	DS-2	Hikvision
②	T	Thermal Camera
③	D	Network
④	2	Structural form: Bullet



⑤	5	Special purpose: explosion-proof, corrosion protection, Bi-spectrum
⑥	X	Resolution: 2, 3, 6, C
⑦	X(T)	Thermal core characteristics: 7, 8 T: Temperature Accuracy
⑧	XXXX	Focal Length: 3, 7, 10, 15, 25, A/B/C/D/E/F/ZSH/ZHY/ZSY (Reserved focal length)
⑨	X	Function extension platform type: Q



2 Appearance Description

2.1 Camera Overview

See the figure below for reference.

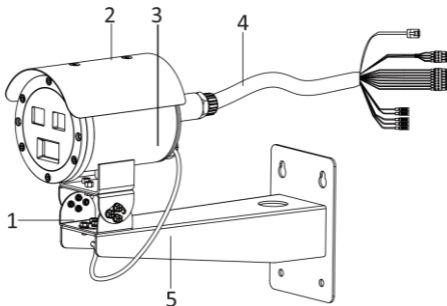

Figure 2-1 Overview of Camera

Table 2-1 Description of Camera

No.	Description
1	PT Joint
2	Sun shield
3	Main body
4	Cable



5

Wall bracket

2.2 Cable Description

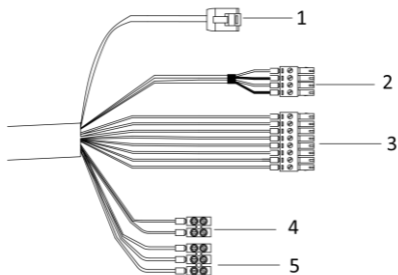

Figure 2-2 Overview of Cables

Table 2-2 Description of Cables

No.	Description
1	RJ45 Ethernet interface
2	Audio input and output
3	Alarm input and output
4	RS-485



5	Power cord
---	------------



3 Installation

Before you start:

- Make sure the device in the package is in good condition and all the assembly parts are included.
- The standard power supply is 220 VAC, please make sure your power supply matches with your camera.
- Make sure all the related equipment is power-off during the installation.
- Check the specification of the products for the installation environment.
- Make sure that the wall is strong enough to withstand four times the weight of the camera and the bracket.

For the camera that supports IR, you are required to pay attention to the following precautions to prevent IR reflection:

- Make sure that there is no reflective surface too close to the camera lens. The IR light from the camera may reflect back into the lens causing reflection.

3.1 Camera Installation

Before you start:

There is a wall mounting bracket included in the package, and you can purchase a terminal box separately.

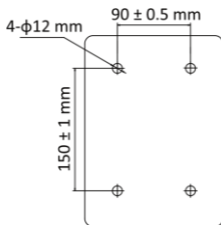

Figure 3-1 Dimension of the Wall Mounting Bracket

Steps:

1. Disassemble the PT joint.

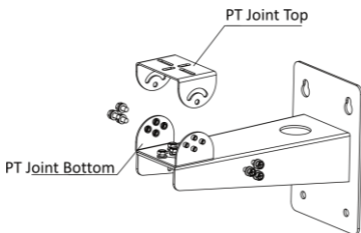

Figure 3-2 Disassemble PT Joint

2. Install the PT joint top to the mounting base of the camera with four 1/4-20UNC screws, then connect the safety rope to the hook of the camera.

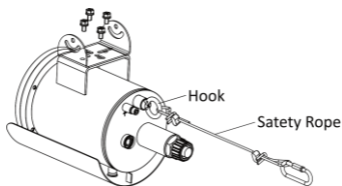

Figure 3-3 Install PT Joint Top with Camera

3. Drill four holes in the wall with a $\Phi 12$ mm drill, and drill four expansion screws into the holes.

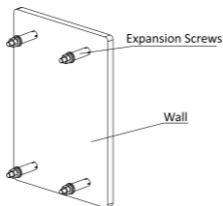

Figure 3-4 Drill Expansion Screws into the Holes

4. Align the four holes on the bracket with the four expansion screws on the wall, install the bracket on the wall, and tighten the screws.

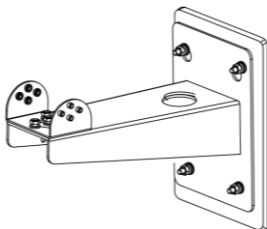

Figure 3-5 Install Bracket on Wall

5. Connect the safety rope to the hole. Align the screw holes on PT joint top with those on PT joint bottom, and install the camera on the bracket.

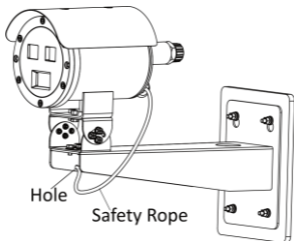

Figure 3-6 Install Camera on Bracket

6. Loosen the screws to adjust the tilting and panning angles of the camera, and tighten the screws after the adjustment. The panning range is -40° to 40° , and the tilting range is -60° to 60° .

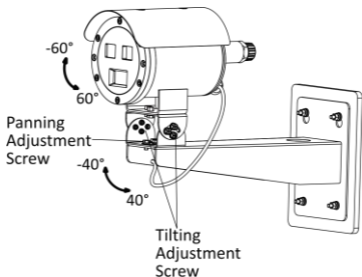

Figure 3-7 Adjust Angle

7. Loosen the grounding screw on the back of the device, thread the external ground terminal through the screw, then tighten the screw.

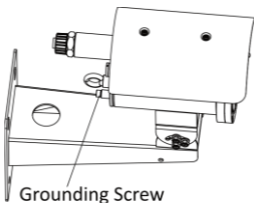

Figure 3-8 Grounding

8. Route the cable through the flexible conduit.

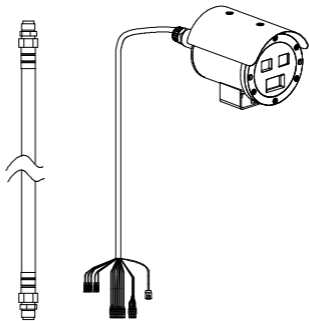

Figure 3-9 Flexible Conduit

Note: Please purchase the flexible conduit separately.

3.2 Terminal Box Installation

Scan the QR code below for the installation guide of explosion-proof terminal box.





4 Setting the Network Camera over the LAN

Note:

You shall acknowledge that the use of the product with Internet access might be under network security risks. For avoidance of any network attacks and information leakage, please strengthen your own protection.

If the product does not work properly, contact your dealer or the nearest service center for help.

4.1 Wiring

Connect the camera to network according to the following figures.



Figure 4-1 Connecting Directly

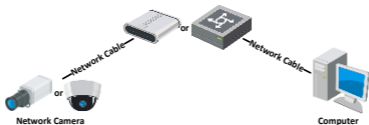

Figure 4-2 Connecting via a Switch or a Router



4.2 Activating the Camera

You are required to activate the camera first by setting a strong password for it before you can use the camera.

Activation via web browser, activation via SADP, and activation via client software are all supported. We will take activation via SADP software and activation via web browser as examples to introduce the camera activation.

Note:

Refer to the User Manual of Network Camera for Activation via Client Software.

4.2.1 Activation via Web Browser

Steps:

1. Power on the camera. Connect the camera to your computer or the switch/router which your computer connects to.
2. Input the IP address into the address bar of the web browser, and press Enter to enter the activation interface.

Notes:

- The default IP address of the camera is 192.168.1.64.
- The computer and the camera should belong to the same subnet.
- For the camera enables the DHCP by default, you need to use the SADP software to search the IP address.

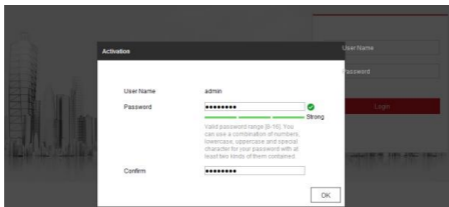

Figure 4-3 Activation Interface(Web)

3. Create a password and input the password into the password field.



STRONG PASSWORD RECOMMENDED— *We highly recommend you create a strong password of your own choosing (using a minimum of 8 characters, including upper case letters, lower case letters, numbers, and special characters) in order to increase the security of your product. And we recommend you reset your password regularly, especially in the high security system, resetting the password monthly or weekly can better protect your product.*

4. Confirm the password.
5. Click **OK** to save the password and enter the live view interface.

4.2.2 Activation via SADP Software

SADP software is used for detecting the online device, activating the camera, and resetting the password.

Get the SADP software from the supplied disk or the official website, and install the SADP according to the prompts.

Follow the steps to activate the camera.

Steps:

1. Run the SADP software to search the online devices.
2. Check the device status from the device list, and select the inactive device.

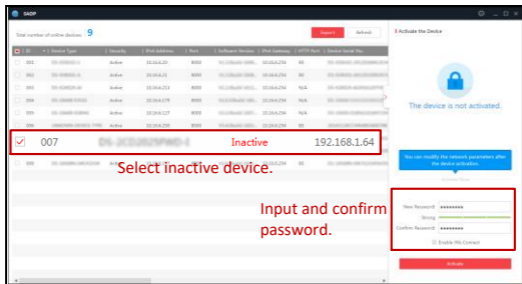

Figure 4-4 SADP Interface

Note:

The SADP software supports activating the camera in batch. Refer to the user manual of SADP software for details.

3. Create and input the new password in the password field, and confirm the password.



STRONG PASSWORD RECOMMENDED– *We highly recommend you create a strong password of your own choosing (using a minimum of 8 characters, including upper case letters, lower case letters, numbers, and special characters) in order to increase the security of your product. And we recommend you reset your password regularly, especially in the high security system, resetting the password monthly or weekly can better protect your product.*

Note:

You can enable the Hik-Connect service for the device during activation. Refer to ***Enable Hik-Connect Service on Camera*** for detailed information.

4. Click **Activate** to start activation.

You can check whether the activation is completed on the popup window. If activation failed, make sure that the password meets the requirement and try again.

4.3 Modifying the IP Address

Purpose:

To view and configure the camera via LAN (Local Area Network), you need to connect the network camera in the same subnet with your PC.

Use the SADP software or client software to search and change the IP address of the device. We take modifying the IP Address via SADP software as an example to introduce the IP address modification.



For IP address modification via client software, refer to the user manual of client software.

Steps:

1. Run the SADP software.
2. Select an active device.
3. Change the device IP address to the same subnet with your computer by either modifying the IP address manually or checking the checkbox of Enable DHCP.



Modify Network Parameters

Enable DHCP
 Enable Hik-Connect

Device Serial No.:

IP Address:

Port:

Subnet Mask:

Gateway:

IPv6 Address:

IPv6 Gateway:

IPv6 Prefix Length:

HTTP Port:

Security Verification

Admin Password:

[Forgot Password](#)

Figure 4-5 Modify the IP Address

Note:

You can enable the Hik-Connect service for the device during activation. Refer to **Enable Hik-Connect Service on Camera** for detailed information.

4. Input the admin password and click **Modify** to activate your IP address modification.



The batch IP address modification is supported by the SADP. Refer to the user manual of SADP for details.



5 Accessing via Web Browser

System Requirement:

Operating System: Microsoft Windows 7 and above version

CPU: 2.0 GHz or higher

RAM: 1 G or higher

Display: 1024 × 768 resolution or higher

Web Browser: Internet Explorer 10 and above version, Apple Safari 12 and above version, Mozilla Firefox 52 and above version and Google Chrome 57 and above version

Steps:

1. Open the web browser.
2. In the browser address bar, input the IP address of the network camera, and press the **Enter** key to enter the login interface.

Note:

- The default IP address is 192.168.1.64. You are recommended to change the IP address to the same subnet with your computer.

3. Input the user name and password.

The admin user should configure the device accounts and user/operator permissions properly. Delete the unnecessary accounts and user/operator permissions.

Note:

The device IP address gets locked if the admin user performs 7 failed password attempts (5 attempts for the user/operator).



4. Click **Login**.



Figure 5-1 Login Interface

5. Install the plug-in before viewing the live video and managing the camera. Follow the installation prompts to install the plug-in.

Note:

You may have to close the web browser to finish the installation of the plug-in.

[Please click here to download and install the plug-in. Close the browser when installing the plug-in.](#)

Figure 5-2 Download Plug-in

6. Reopen the web browser after the installation of the plug-in and repeat steps 2 to 4 to login.

Note:

For detailed instructions of further configuration, please refer to the user manual of network camera.



6 Operating via Hik-Connect App

Purpose:

Hik-Connect is an application for mobile devices. With the App, you can view live image of the camera, receive alarm notification and so on.

Note:

Hik-Connect service is not supported by certain camera models.

6.1 Enable Hik-Connect Service on Camera

Purpose:

Hik-Connect service should be enabled on your camera before using the service.

You can enable the service through SADP software or web browser.

6.1.1 Enable Hik-Connect Service via SADP Software

Steps:

1. Check the checkbox of **Enable Hik-Connect** on:
 - 1). "Activate the Device" page during camera activation, refer to **Activation via SADP Software**.
 - 2). Or "Modify Network Parameters" page during modifying IP address, refer to **Modifying the IP Address**.
2. Create a verification code or change the verification code.

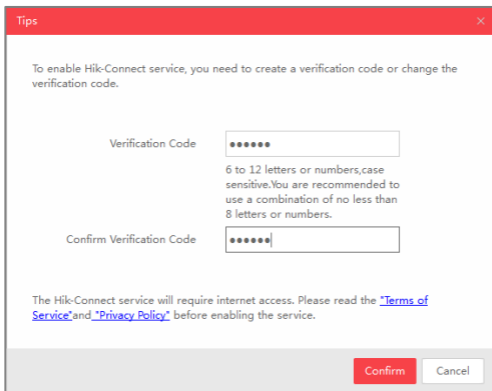

Figure 6-1 Verification Code Setting (SADP)

Note:

The verification code is required when you add the camera to Hik-Connect app.

3. Click and read "Terms of Service" and "Privacy Policy".
4. Confirm the settings.

6.1.2 Enable Hik-Connect Service via Web Browser

Before you start:

You need to activate the camera before enabling the service. Refer to **Activating the Camera**.



Steps:

1. Access the camera via web browser. Refer to **Accessing via Web Browser**.
2. Enter platform access configuration interface: Configuration > Network > Advanced Settings > Platform Access

Enable

Platform Access Mode:

Server IP: Custom

Register Status:

Verification Code:

6 to 12 letters (a to z, A to Z) or numbers (0 to 9), case sensitive. You are recommended to use

Figure 6-2 Platform Access Configuration (Web)

3. Select Platform Access Mode as Hik-Connect.
4. Check the checkbox of Enable.
5. Click and read "Terms of Service" and "Privacy Policy" in pop-up window.
6. Create a verification code or change the verification code for the camera.

Note:

The verification code is required when you add the camera to Hik-Connect app.

7. Save the settings.



6.2 Hik-Connect Setup

Steps:

1. Download and install the Hik-Connect app by searching “Hik-Connect” in App Store or Google Play™.
2. Launch the app and register for a Hik-Connect user account.
3. Log in Hik-Connect app after registration.

6.3 Adding Camera to Hik-Connect

Before you start:

You need to enable the Hik-Connect service on camera before adding it to your Hik-Connect account. Refer to **Enable Hik-Connect Service on Camera**.

Steps:

1. Use a network cable to connect the camera with a router if the camera does not support Wi-Fi.



Figure 6-3 Connect a Router

Note:

After the camera connects to the network, please wait one minute before any operation on the camera using Hik-Connect app.

2. In the Hik-Connect app, tap “+” on the upper-right corner and then scan the QR code of the camera to add the camera.



You can find the QR code on the camera or on the cover of the Quick Start Guide of the camera in the package.

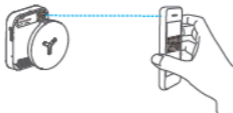



Figure 6-4 Scan QR Code

Note:

If the QR code is missing or too blur to be recognized, you can also add the camera by tapping the  icon and inputting the camera's serial number.

3. Input the verification code of your camera.

Note:

- The required verification code is the code you create or change when you enabling Hik-Connect service on camera.
- If you forget the verification code, you can check the current verification code on **Platform Access** configuration page via web browser.

4. Follow the prompts to set the network connection and add the camera to your Hik-Connect account.

Note:

For detailed information, refer to the user manual of the Hik-Connect app.



6.4 Initializing the Memory Card

Check the memory card status by tapping on **Storage Status** in the device settings interface.

If the memory card status displays as Uninitialized, tap to initialize it. The status will then change to Normal. You can then start recording any event triggered video in the camera such as motion detection.

