



Video Wall Controller

User Manual

Legal Information

©2020 Hangzhou Hikvision Digital Technology Co., Ltd. All rights reserved.

About this Manual

The Manual includes instructions for using and managing the Product. Pictures, charts, images and all other information hereinafter are for description and explanation only. The information contained in the Manual is subject to change, without notice, due to firmware updates or other reasons. Please find the latest version of this Manual at the Hikvision website (<https://www.hikvision.com/>).

Please use this Manual with the guidance and assistance of professionals trained in supporting the Product.

Trademarks

HIKVISION and other Hikvision's trademarks and logos are the properties of Hikvision in various jurisdictions.

Other trademarks and logos mentioned are the properties of their respective owners.



: The terms HDMI and HDMI High-Definition Multimedia Interface, and the HDMI Logo are trademarks or registered trademarks of HDMI Licensing Administrator, Inc. in the United States and other countries.

Disclaimer

TO THE MAXIMUM EXTENT PERMITTED BY APPLICABLE LAW, THIS MANUAL AND THE PRODUCT DESCRIBED, WITH ITS HARDWARE, SOFTWARE AND FIRMWARE, ARE PROVIDED "AS IS" AND "WITH ALL FAULTS AND ERRORS". HIKVISION MAKES NO WARRANTIES, EXPRESS OR IMPLIED, INCLUDING WITHOUT LIMITATION, MERCHANTABILITY, SATISFACTORY QUALITY, OR FITNESS FOR A PARTICULAR PURPOSE. THE USE OF THE PRODUCT BY YOU IS AT YOUR OWN RISK. IN NO EVENT WILL HIKVISION BE LIABLE TO YOU FOR ANY SPECIAL, CONSEQUENTIAL, INCIDENTAL, OR INDIRECT DAMAGES, INCLUDING, AMONG OTHERS, DAMAGES FOR LOSS OF BUSINESS PROFITS, BUSINESS INTERRUPTION, OR LOSS OF DATA, CORRUPTION OF SYSTEMS, OR LOSS OF DOCUMENTATION, WHETHER BASED ON BREACH OF CONTRACT, TORT (INCLUDING NEGLIGENCE), PRODUCT LIABILITY, OR OTHERWISE, IN CONNECTION WITH THE USE OF THE PRODUCT, EVEN IF HIKVISION HAS BEEN ADVISED OF THE POSSIBILITY OF SUCH DAMAGES OR LOSS.

YOU ACKNOWLEDGE THAT THE NATURE OF INTERNET PROVIDES FOR INHERENT SECURITY RISKS, AND HIKVISION SHALL NOT TAKE ANY RESPONSIBILITIES FOR ABNORMAL OPERATION, PRIVACY LEAKAGE OR OTHER DAMAGES RESULTING FROM CYBER-ATTACK, HACKER ATTACK, VIRUS INSPECTION, OR OTHER INTERNET SECURITY RISKS; HOWEVER, HIKVISION WILL PROVIDE TIMELY TECHNICAL SUPPORT IF REQUIRED.

YOU AGREE TO USE THIS PRODUCT IN COMPLIANCE WITH ALL APPLICABLE LAWS, AND YOU ARE SOLELY RESPONSIBLE FOR ENSURING THAT YOUR USE CONFORMS TO THE APPLICABLE LAW. ESPECIALLY, YOU ARE RESPONSIBLE, FOR USING THIS PRODUCT IN A MANNER THAT DOES NOT

Video Wall Controller User Manual

INFRINGE ON THE RIGHTS OF THIRD PARTIES, INCLUDING WITHOUT LIMITATION, RIGHTS OF PUBLICITY, INTELLECTUAL PROPERTY RIGHTS, OR DATA PROTECTION AND OTHER PRIVACY RIGHTS. YOU SHALL NOT USE THIS PRODUCT FOR ANY PROHIBITED END-USES, INCLUDING THE DEVELOPMENT OR PRODUCTION OF WEAPONS OF MASS DESTRUCTION, THE DEVELOPMENT OR PRODUCTION OF CHEMICAL OR BIOLOGICAL WEAPONS, ANY ACTIVITIES IN THE CONTEXT RELATED TO ANY NUCLEAR EXPLOSIVE OR UNSAFE NUCLEAR FUEL-CYCLE, OR IN SUPPORT OF HUMAN RIGHTS ABUSES.

IN THE EVENT OF ANY CONFLICTS BETWEEN THIS MANUAL AND THE APPLICABLE LAW, THE LATER PREVAILS.

Regulatory Information

FCC Information

Please take attention that changes or modification not expressly approved by the party responsible for compliance could void the user's authority to operate the equipment.

FCC compliance: This equipment has been tested and found to comply with the limits for a Class B digital device, pursuant to part 15 of the FCC Rules. These limits are designed to provide reasonable protection against harmful interference in a residential installation. This equipment generates, uses and can radiate radio frequency energy and, if not installed and used in accordance with the instructions, may cause harmful interference to radio communications. However, there is no guarantee that interference will not occur in a particular installation. If this equipment does cause harmful interference to radio or television reception, which can be determined by turning the equipment off and on, the user is encouraged to try to correct the interference by one or more of the following measures:

- Reorient or relocate the receiving antenna.
- Increase the separation between the equipment and receiver.
- Connect the equipment into an outlet on a circuit different from that to which the receiver is connected.
- Consult the dealer or an experienced radio/TV technician for help.

FCC Conditions

This device complies with part 15 of the FCC Rules. Operation is subject to the following two conditions:

1. This device may not cause harmful interference.
2. This device must accept any interference received, including interference that may cause undesired operation.

EU Conformity Statement



This product and - if applicable - the supplied accessories too are marked with "CE" and comply therefore with the applicable harmonized European

standards listed under the EMC Directive 2014/30/EU, the RoHS Directive 2011/65/EU.



2012/19/EU (WEEE directive): Products marked with this symbol cannot be disposed of as unsorted municipal waste in the European Union. For proper recycling, return this product to your local supplier upon the purchase of equivalent new equipment, or dispose of it at designated collection points. For more information see: <http://www.recyclethis.info>.



2006/66/EC (battery directive): This product contains a battery that cannot be disposed of as unsorted municipal waste in the European Union. See the product documentation for specific battery information. The battery is marked with this symbol, which may include lettering to indicate cadmium (Cd), lead (Pb), or mercury (Hg). For proper recycling, return the battery to your supplier or to a designated collection point. For more information see: <http://www.recyclethis.info>.

Industry Canada ICES-003 Compliance

This device meets the CAN ICES-3 (B)/NMB-3(B) standards requirements.

Preface

Applicable Model

This manual is applicable to video wall controllers.



About the Default

This device has the following defaults:

Parameter	Default Value
User name	admin
IP address	192.0.0.64

Symbol Conventions

The symbols that may be found in this document are defined as follows.

Symbol	Description
 Danger	Indicates a hazardous situation which, if not avoided, will or could result in death or serious injury.
 Caution	Indicates a potentially hazardous situation which, if not avoided, could result in equipment damage, data loss, performance degradation, or unexpected results.
 Note	Provides additional information to emphasize or supplement important points of the main text.

Safety Instructions

Warning

- In the use of the product, you must be in strict compliance with the electrical safety regulations of the nation and region.
- Use the power adapter delivered with the device only.
- The socket-outlet shall be installed near the equipment and shall be easily accessible.
- This equipment is not suitable for use in locations where children are likely to be present.

- **CAUTION:** Risk of explosion if the battery is replaced by an incorrect type.
- Improper replacement of the battery with an incorrect type may defeat a safeguard (for example, in the case of some lithium battery types).
- Do not dispose of the battery into fire or a hot oven, or mechanically crush or cut the battery, which may result in an explosion.
- Do not leave the battery in an extremely high temperature surrounding environment, which may result in an explosion or the leakage of flammable liquid or gas.
- Do not subject the battery to extremely low air pressure, which may result in an explosion or the leakage of flammable liquid or gas.
- Dispose of used batteries according to the instructions.
- Never place the equipment in an unstable location. The equipment may fall, causing serious personal injury or death.
- If smoke, odor or noise rise from the device, turn off the power at once and unplug the power cable, and then please contact the service center.
- If the product does not work properly, please contact your dealer or the nearest service center. Never attempt to disassemble the product yourself. (We shall not assume any responsibility for problems caused by unauthorized repair or maintenance.)
- Please enhance the protection for personal information and data security as the device may be confronted with the network security problems when it is connected to the Internet. Please contact your dealer or the nearest service center once you find that there may be the network security problems.

Caution

- Do not drop the device or subject it to physical shock, and do not expose it to high electromagnetism radiation. Avoid the equipment installation on vibrations surface or places subject to shock (ignorance can cause equipment damage).
- Do not expose the device to the explosive situation.
- Keep clean and dry on the surface of the device.
- Do not touch the exposed connection points or components when the device is powered on.
- The ventilation should not be impeded by covering the ventilation openings with items, such as newspapers, table-cloths, curtains, etc. The openings shall never be blocked by placing the equipment on a bed, sofa, rug or other similar surface.
- No naked flame sources, such as lighted candles, should be placed on the equipment.
- The equipment shall not be exposed to dripping or splashing and that no objects filled with liquids, such as vases, shall be placed on the equipment.
- Keep a minimum 50 cm distance around the equipment for sufficient ventilation.

Contents

Chapter 1 Product Introduction	1
1.1 Overview	1
1.2 Key Feature	1
1.3 Packing List	1
1.4 Device Appearance	2
1.4.1 Front Panel	2
1.4.2 Rear Panel	3
1.5 Client Management Software	4
1.6 Operation Process	5
Chapter 2 Activate and Add Devices	6
2.1 Activate Your Device	6
2.2 Add Your Device	6
2.2.1 Add Device by IP Address or Domain Name	7
2.2.2 Add Devices by IP Segment	8
2.3 Configure Network Parameters	9
Chapter 3 Artistic Video Wall Configuration	10
3.1 Configure Displays	10
3.1.1 Add Displays	10
3.1.2 Configure Display Properties	11
3.1.3 Adjust Display Positions	11
3.2 Configure an Input Source	13
3.3 Configure a Device Topology	15
3.3.1 Change a Device Topology	16
3.3.2 Check Device Topology Status	16
3.4 Layout Management	17
3.4.1 Save a Layout File	18

3.4.2 Print a Layout File	18
3.4.3 Import a Layout File	19
3.5 Configure Mirroring Display	19
Chapter 4 Device Installation and Cabling	22
4.1 Install Your Devices	22
4.2 Connect Cables	22
4.2.1 Cable Connection Requirements	22
4.2.2 Cable Connection Description	23
Chapter 5 Device Configuration and Maintenance	26
5.1 Configure the Device Name and Device No.	26
5.2 Configure Device Time	26
5.3 Reset Device Password	27
5.4 View Device Information	28
5.5 Configure Serial Parameters	28
5.6 Configure Security Parameters	29
5.7 Import and Export a Configuration File	29
5.8 Query and Back Up Logs	29
5.9 Restore Default Parameters	30
5.10 Restart a Device Remotely	30
5.11 Upgrade a Device Remotely	30
Chapter 6 User Management	31
Chapter 7 Operation and Maintenance	32
Chapter 8 Get More Information	33

Chapter 1 Product Introduction

1.1 Overview

The video wall controller is a pure hardware image processing device based on Field Programmable Gate Array (FPGA), which supports 4K@60 Hz signal input and random rotation and placement of displays for achieving more creative and eye-catching display effects. Due to its good compatibility, LCD, DLP, and LED screens can work together to form a larger screen, which applies to various video wall scenarios such as shopping malls, conference rooms and lecture halls.

1.2 Key Feature

- 1 × HDMI 4K input, 4 × HDMI output
- 4 device cascading, controlling up to 16-display video wall
- Accurate to 0.1° rotation for a single display
- Various display solutions with display mirroring and replication
- Pix SYNC technology for synchronized image
- Bezel compensation technology for continuous image
- Export video wall design drawings for project deployment
- Simple and easy-to-use software

1.3 Packing List

Before using the product, check whether the following items are included in the package. If any items are found damaged or missing, please contact our technical support engineers.

Table 1-1 Packing List

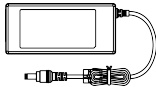
No.	Item	Picture	Quantity
1	Device		1
2	Power adapter		1

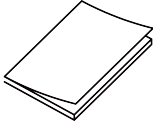
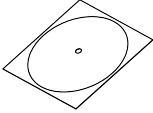
No.	Item	Picture	Quantity
3	User manual		1
4	CD-ROM		1

1.4 Device Appearance



Figure 1-1 Device Appearance

1.4.1 Front Panel

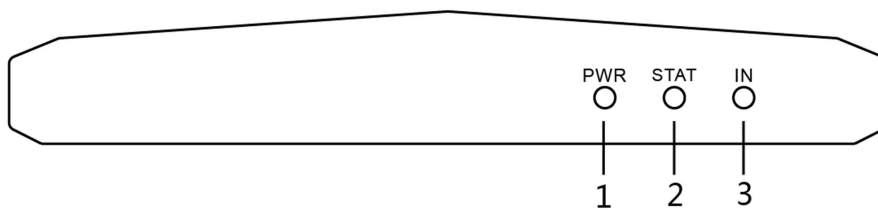

Figure 1-2 Front Panel

Table 1-2 Front Panel Interface Description

No.	Name	Description
1	PWR	Power indicator Turns steady red after power-on
2	STAT	System status indicator <ul style="list-style-type: none"> • Unlit during startup or in the faulty state • Turns green after startup
3	IN	Indicator for the HDMI IN interface

No.	Name	Description
		<ul style="list-style-type: none"> • Signals are not inputting and not displayed on the video wall: unlit • Signals are displayed on the video wall but not inputting: green • Signals are inputting but not displayed on the video wall: red • Signals are inputting and displayed on the video wall: blinking red and green alternately

1.4.2 Rear Panel

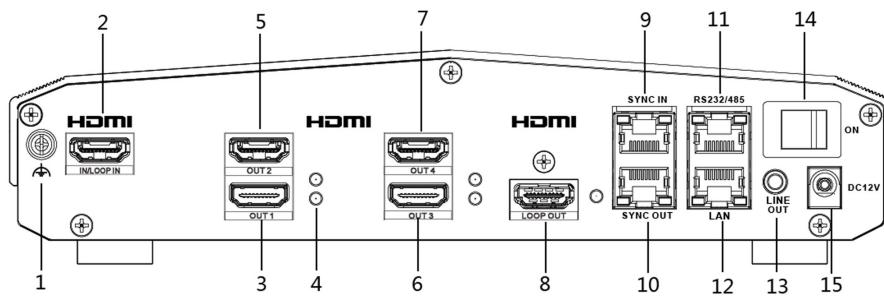



Figure 1-3 Rear Panel

Table 1-3 Rear Panel Interface Description

No.	Name	Description
1	Grounding screw	Used for grounding the device
2	HDMI IN / LOOP IN	<ul style="list-style-type: none"> • HDMI input interface, up to 4K@60 Hz input • Used for loop input when multiple devices are cascaded <p>Note</p> <p>When devices are cascaded, you can only use the HDMI input interface of the master device to input signals.</p>
3	HDMI OUT 1	HDMI output interface 1, up to 4K@30 Hz output
4	HDMI Interface Indicator	<p>Status indicator of HDMI OUT 1 interface, working similarly with the other 3 HDMI out interfaces</p> <ul style="list-style-type: none"> • Connected with a cable: steady green • Disconnected with a cable: unlit
5	HDMI OUT 2	HDMI output interface 2, up to 4K@30 Hz output
6	HDMI OUT 3	HDMI output interface 3, up to 4K@30 Hz output
7	HDMI OUT 4	HDMI output interface 4, up to 4K@30 Hz output

No.	Name	Description
8	HDMI LOOP OUT	HDMI loop output interface for device cascading, up to 4K@60 Hz output
9	SYNC IN	Sync input interface for synchronizing signals between devices
10	SYNC OUT	Sync output interface for synchronizing signals between devices
11	RS-232/RS485	RS232 and RS485 multiplexing port only for debugging, configurable on the client
12	LAN	10/100/1000 Mbps adaptive network interface, IEEE 802.3at PoE
13	LINE OUT	Audio output interface  Note When devices are cascaded, you can only use the line output interface of the master device to output audio signals.
14	DC 12 V Switch	Switch of 12 V/2 A power input, alternative to the PoE power supply method
15	DC 12 V IN	Interface for 12 V/2 A power input, alternative to the PoE power supply method

1.5 Client Management Software

Video wall controllers can be managed on the Artistic Wall Client, including activation, adding, configuration, management and maintenance. Obtain the client installation package from the CD-ROM or website, double click the package, and finish the installation.

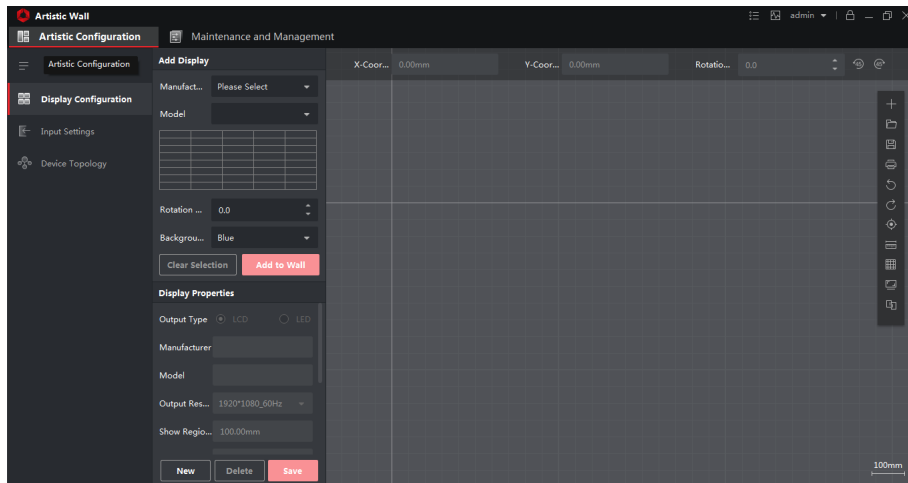

Figure 1-4 Client Management Software

1.6 Operation Process

The following figure describes the basic operation process of creating an artistic video wall.

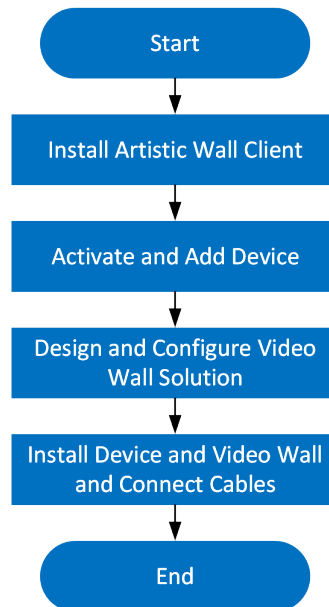

Figure 1-5 Operation Process of Creating an Artistic Video Wall

Chapter 2 Activate and Add Devices

2.1 Activate Your Device

For the inactive devices, you are required to create a password to activate them before they can be added to the software and work properly.

Before You Start

Make sure the device to be activated is connected to the network and is in the same subnet with the PC running the client.

Steps

1. Enter the **Maintenance and Management** → **Device Management** interface.
2. Click **Online Device** to show the online device area at the bottom of the interface.
The searched online devices are displayed in the list.
3. Check the device status (shown on **Security Level** column) and select an inactive device.

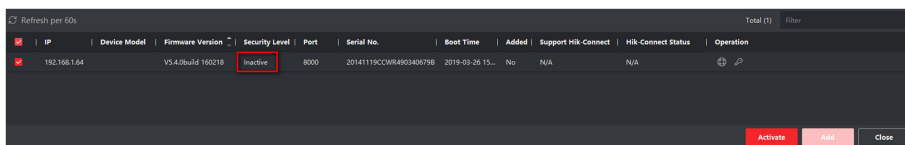

Figure 2-1 Online Inactive Device

4. Click **Activate** to open the **Activation** box.
5. Create a password in the password field, and confirm the password.



Caution

The password strength of the device can be automatically checked. We highly recommend you change the password of your own choosing (using a minimum of 8 characters, including at least three kinds of following categories: upper case letters, lower case letters, numbers, and special characters) in order to increase the security of your product. And we recommend you change your password regularly, especially in the high security system, changing the password monthly or weekly can better protect your product.

Proper configuration of all passwords and other security settings is the responsibility of the installer and/or end-user.

6. Click **OK** to activate the device.

2.2 Add Your Device

You can add your devices by IP/domain or IP segment.

2.2.1 Add Device by IP Address or Domain Name

If you know the IP address or domain name of the device to add, you can add devices to the client by specifying the IP address (or domain name), user name, password, etc.

Steps

1. Click **Maintenance** → **Device Management** .
2. Click **Add** to open the **Add** window, and then select **IP/Domain** as the adding mode.
3. Enter the required information.

Name

Create a descriptive name for the device. For example, you can use a nickname that can show the location or feature of the device.

Address

The IP address or domain name of the device.

Port

The devices to add share the same port number. The default value is **8000**.

User Name

Enter the device user name. By default, the user name is **admin**.

Password

Enter the device password.



Caution



The password strength of the device can be automatically checked. We highly recommend you change the password of your own choosing (using a minimum of 8 characters, including at least three kinds of following categories: upper case letters, lower case letters, numbers, and special characters) in order to increase the security of your product. And we recommend you change your password regularly, especially in the high security system, changing the password monthly or weekly can better protect your product.

Proper configuration of all passwords and other security settings is the responsibility of the installer and/or end-user.

4. Check **Synchronize Time** to synchronize the device time with the PC running the client after adding the device to the client.
5. Finish adding the device.
 - Click **Add** to add the device and back to the device list page.
 - Click **Add and New** to save the settings and continue to add other device.
6. **Optional:** Perform the following operation(s).

Remote Configuration

Click  on **Operation** column to set remote configuration of the corresponding device.

View Device Status	Click  on Operation column to view device status, including cameras, recording status, signal status, hardware status, etc.
Edit Device Information	Click  on Operation column to edit the device information, such as IP address, user name, and password.
Refresh	Click  on Operation column to get the latest device information.
Delete Device	Select one or multiple devices and click Delete to delete the selected device(s) from the client.

2.2.2 Add Devices by IP Segment

If the devices share the same port No., user name and password, and their IP addresses range in the same IP segment, you can add them to the client by specifying the start IP address and the end IP address, port No., user name, password, etc of the devices.

Steps

1. Click **Maintenance** → **Device Management** .
2. Click **Add** to open the **Add** window.
3. Select **IP Segment** as the adding mode.
4. Enter the required information.

Start IP

Enter a start IP address.

End IP

Enter an end IP address in the same network segment with the start IP.

Port

Enter the device port No. The default value is **8000**.

User Name

By default, the user name is **admin**.

Password

Enter the device password.



Caution

The password strength of the device can be automatically checked. We highly recommend you change the password of your own choosing (using a minimum of 8 characters, including at least three kinds of following categories: upper case letters, lower case letters, numbers, and special characters) in order to increase the security of your product. And we recommend you change your password regularly, especially in the high security system, changing the password monthly or weekly can better protect your product.

Proper configuration of all passwords and other security settings is the responsibility of the installer and/or end-user.

5. Check **Synchronize Time** to synchronize the device time with the PC running the client after adding the device to the client.
6. Finish adding the device.
 - Click **Add** to add the device and back to the device list page.
 - Click **Add and New** to save the settings and continue to add other device.

2.3 Configure Network Parameters

After your device is added to the client, you can configure network parameters of your device as needed, including the IP address, subnet mask, and gateway.

Steps

1. On the **Device Management** interface, select the desired device in the list and click **Remote Configuration** on the **Operation** column.
2. Click **Network → General** .
3. Configure the network parameter, including the IP address, subnet mask, and gateway.
4. Click **Save**.

Chapter 3 Artistic Video Wall Configuration

This chapter describes how to design an artistic video wall solution on the client. Designing a video wall solution includes configuring monitors, configuring input signal sources, and linking devices with the video wall. You can design your video wall in offline mode and apply the configuration to your devices.

3.1 Configure Displays

A video wall consists of multiple monitors or displays. Add displays based on the actual video wall configuration and configure the positions, angles, and properties of your displays. After finishing display configuration, you can export it as a reference for onsite deployment.

3.1.1 Add Displays

Before designing your video wall, add displays to the video wall on the client.

Steps

1. Click **Artistic Configuration** → **Display Configuration** .

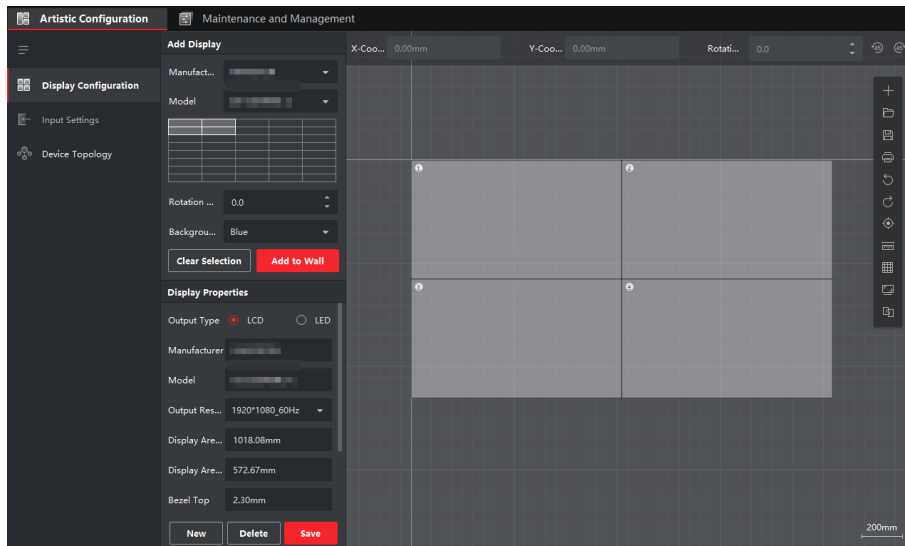

Figure 3-1 Add Display

2. Select **Manufacturer** and **Model**. If the client does not show the desired manufacturer and model, click **New** on the bottom to add a new model and configure the properties and click **Save**.
3. Click and select the desired video wall scale in the grid.
4. **Optional:** Set **Rotation** of your displays. Your displays can be rotated clockwise at any desired angle, accurate to 0.1 degree.

5. **Optional:** Set **Background Color** of your displays. The background color applies to all displays.
6. Click **Add to Wall** to add the displays to the video wall canvas on the right.

3.1.2 Configure Display Properties

After adding displays to the wall, configure display properties to ensure proper displaying.

Steps

1. Click **Artistic Configuration → Display Configuration** .
2. Select a display on the wall and configure the properties.

Table 3-1 Description of Display Properties

Property	Description
Output Type	Output type of your display. LCD and LED types are available.
Manufacturer/Model	Manufacturer and model of your display. After the manufacturer and model are selected, the rest of the properties are automatically configured. Please check that the values are consistent with the actual values.
Output Resolution	Please select the proper resolution based on the actual need.
Display Area Width/Height	Enter the actual display area width and height of your display. The display area does not include the borders and bezels around the area.
Bezel Top/Bottom/Left/Right	Bezel width on the top, bottom, left, and right of the screen. The bezel width here is made up of the widths of the physical bezel and the black border.
LED Resolution	Only available when your display is an LED type. The resolution must be smaller than or equal to Output Resolution but greater than 288 × 288, and the width should be a multiple of two.

3. Click **Save**.

3.1.3 Adjust Display Positions

After adding and configuring the displays, adjust the positions to obtain an artistic video wall effect.

Steps

1. Click **Artistic Configuration → Display Configuration** .
2. Select a display on the wall, and adjust its position.

 **Note**

Do not overlap displays when adjusting display positions. Dotted-line boxes appear around if displays are overlapped.

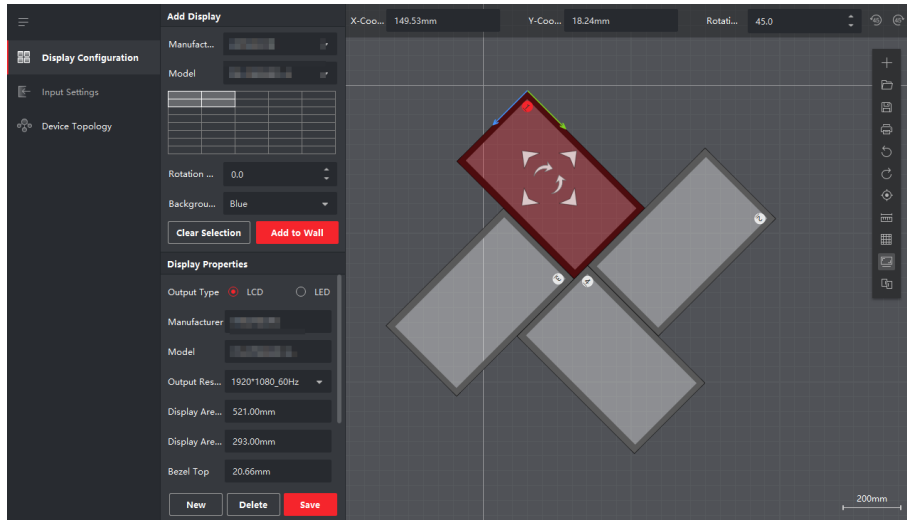



Figure 3-2 Adjust Display Positions

Table 3-2 Description of Display Position Adjustment

Function	Description
X-Coordinate/Y-Coordinate	Enter the X and Y coordinates of the reference point (the junction of the green line and the blue line), and the display will be moved to the corresponding position.
Rotation Angle	Enter the rotation angle, and the display will be rotated at the desired angle clockwise from the reference point (the junction of the green line and the blue line).
	Click the icons to rotate the display at 45 degrees clockwise or anticlockwise from the reference point (the junction of the green line and the blue line).

3. Select a display and adjust it precisely using direction arrows appeared in the center of the display.









Figure 3-3 Adjust Display Precisely

Table 3-3 Description of Precise Position Adjustment

Function	Description
Up/Down/Left/Right arrows	Click the arrows to move the display to the corresponding directions by 1 mm at a time.
Clockwise/ Anticlockwise arrows	Click the arrows to rotate the display clockwise or anticlockwise by 0.1 degree at a time. Click and hold the arrows to rotate the display clockwise or anticlockwise by the desired degree.

4. Use the function icons on the toolbar to adjust the video wall layout.

Table 3-4 Description of the Function Toolbar on the Right Side

Icon	Description	Icon	Description
	Create a video wall canvas.		Cancel the current operation.
	Restore the previous operation.		Center the video wall in the canvas.
	Show the measurements of the whole video wall, a single display, and the distance between two displays.		Align to the grid in the video wall canvas when moving a display.
	Align and snap to other displays when moving a display.	-	-

 **Note**

When devices are cascaded for fusion input of ultra-high resolution signals, you need to manually adjust the sizes of the signal input windows to form a rectangle shape without gaps between windows.

3.2 Configure an Input Source

After configuring the video wall layout, configure an input source for the video wall.

Steps

1. Click **Artistic Configuration** → **Input Settings** .

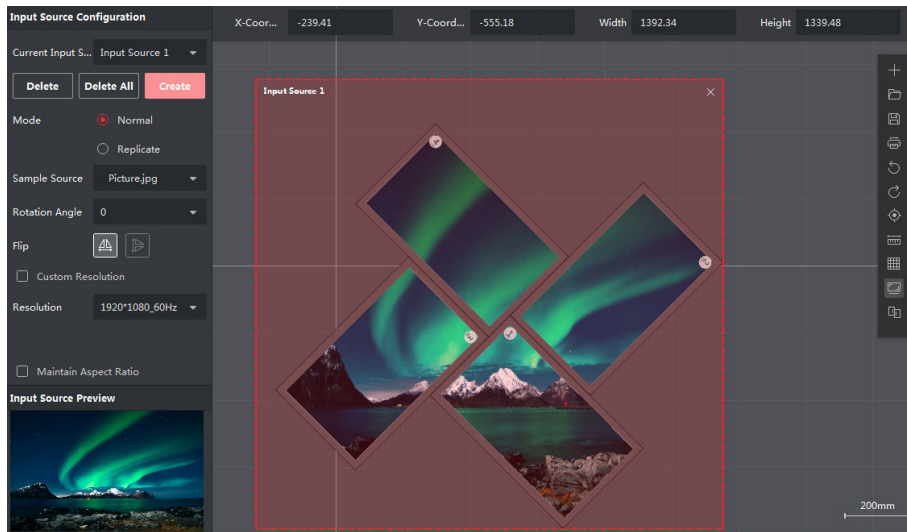

Figure 3-4 Configure an Input Source

2. Click **Create** to automatically create an input source for the current video wall.
3. Select a sample source file stored on the client or on your local computer to display in the window and check the display effect. Pictures and videos are supported.
4. Select the input source mode. **Normal** and **Replicate** modes are available.

Normal

The input source covers the entire display area of the video wall.

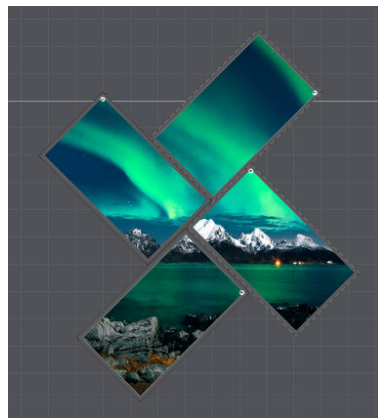

Figure 3-5 Normal Mode

Replicate

All displays show the same image.

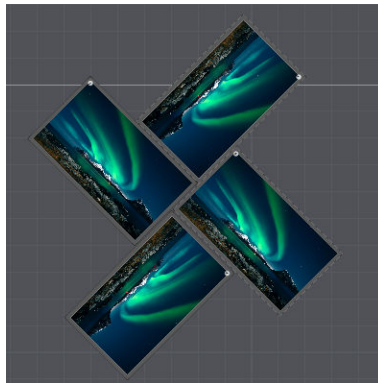



Figure 3-6 Replicate Mode

 **Caution**

In **Replicate** mode, the displays are adjusted to have the same output resolution, which is consistent with that of the display connected to the HDMI OUT 1 interface.

5. **Optional:** Select the rotation angle to rotate the image at the corresponding angle. 0°, 90°, 180°, and 270° are available.
 6. **Optional:** In normal mode, click  to flip the image horizontally or click  to flip the image vertically.
 7. Set the resolution of the input source. The resolution must be the same as the actual resolution of the input source. Otherwise, the image will not be displayed properly.
 - Select a standard resolution from the drop-down list.
 - Click **Custom Resolution** to set a custom resolution. If the resolution of the input source does not match that of the on-site video wall, you can customize the resolution of the input source so that they are matched.
-

 **Note**

- The custom resolution must be a value between 1280 × 720 and 4092 × 2160. The width must be a multiple of 4, and the height a multiple of 2.
 - When both the width is greater than 2560 and the height is greater than 1440, the frame rate 25/30/60 is available. Otherwise, only the frame rate 60 is available.
-
8. **Optional:** In normal mode, you can drag the input source border, the red dashed box, to change the size of the image in the display area. When **Maintain Aspect Ratio** is selected, the width and height of the image are changed simultaneously in a certain aspect ratio.

3.3 Configure a Device Topology

If your video wall has more than four screens, you can cascade multiple devices to support a larger video wall. The client automatically configures a cascading topology for you to connect physical devices according to the topology. A maximum four devices are supported in a cascading relationship.

3.3.1 Change a Device Topology

You can change the device topology as needed.

Steps

1. Click **Artistic Configuration → Device Topology** . The client automatically configures a cascading topology for your devices, and you can connect physical devices according to the topology.

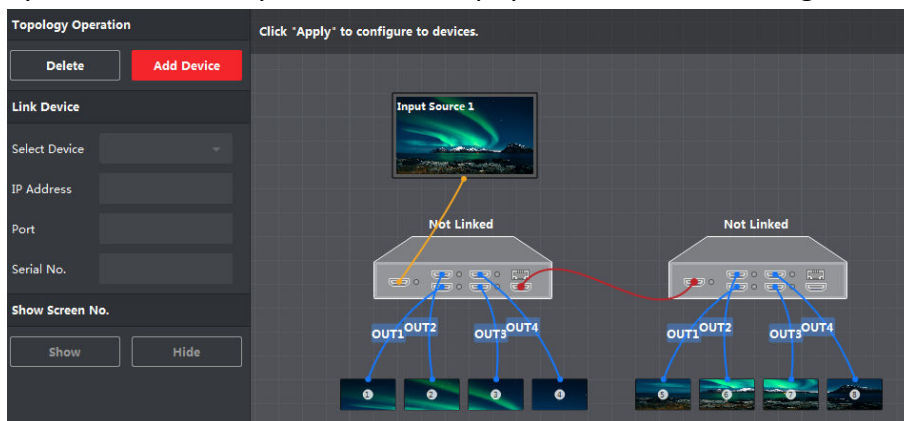

Figure 3-7 Configure a Device Topology

2. Change connection lines in the topology as needed.

Table 3-5 Description of Changing the Device Topology

Operation	Description
Add or delete a device	Click Create or Delete to add or delete a device.
Change a connection line	Click one interface, hold and move your mouse to draw a connection line to the other interface.
Change a loop line	Click the loop out interface of one device, hold and move your mouse to draw a connection line to the loop in interface of the other device.

Note

- The topology relationship must be consistent with the actual device relationship.
- After the cascading topology is configured, only the HDMI input interface of the master device can be used to input signals.

3.3.2 Check Device Topology Status

You can check device information and topology status on the client, such as the device cascading relationship, cable connection status, and status of signal input and output interfaces.

Steps

1. Click **Artistic Configuration → Device Topology** .

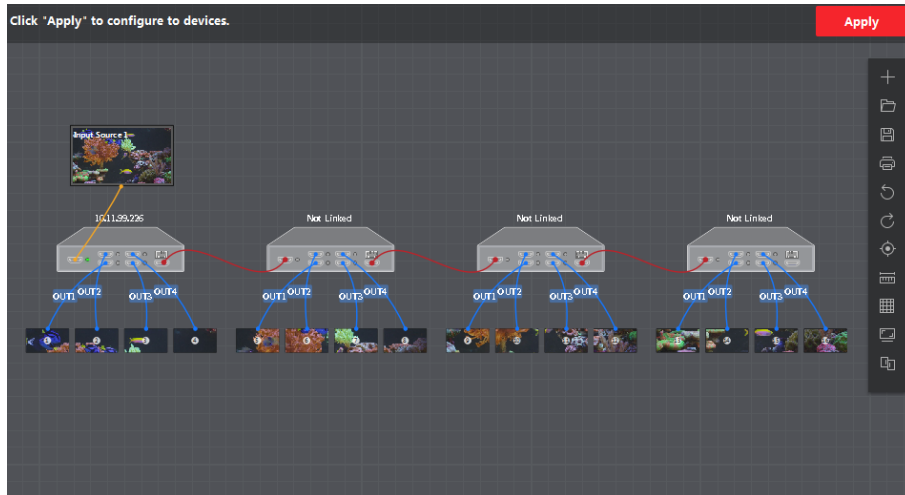

Figure 3-8 View Topology Status

2. Check the device cascading relationship, cable connection status, and status of signal input and output interfaces. The following table describes the connection lines and indicators.

Table 3-6 Description of Connection Lines and Indicators

Name	Color Description
Connection line	<ul style="list-style-type: none"> • Loop connection line: red • Signal output connection line: blue • Signal input connection line: yellow
Signal input indicators (the leftmost one)	<ul style="list-style-type: none"> • Signals are not inputting and not displayed on the video wall: gray • Signals are displayed on the video wall but not inputting: green • Signals are inputting but not displayed on the video wall: red • Signals are inputting and displayed on the video wall: blinking red and green alternately
Signal output indicators (the middle four)	<ul style="list-style-type: none"> • Signal output interface connected with the video wall: green • Signal output interface disconnected with the video wall: gray
Sync interface	<ul style="list-style-type: none"> • Sync line connected: green • Sync line disconnected: gray

3.4 Layout Management

The video wall layout can be saved and imported to the client as a file. You can also print the layout file as a reference for on-site deployment.

3.4.1 Save a Layout File

You can save a video wall layout as a file which can be used as a template to provide reference for other projects.

Steps

1. Click **Artistic Configuration → Display Configuration**.
2. Click  to save the current video wall layout to the specified directory in the local computer.

3.4.2 Print a Layout File

You can print a video wall layout, containing information such as display properties, width and height, and positions, as a guide for onsite deployment.

Steps

1. Click **Artistic Configuration → Display Configuration**.
2. Click  to print the video wall layout.

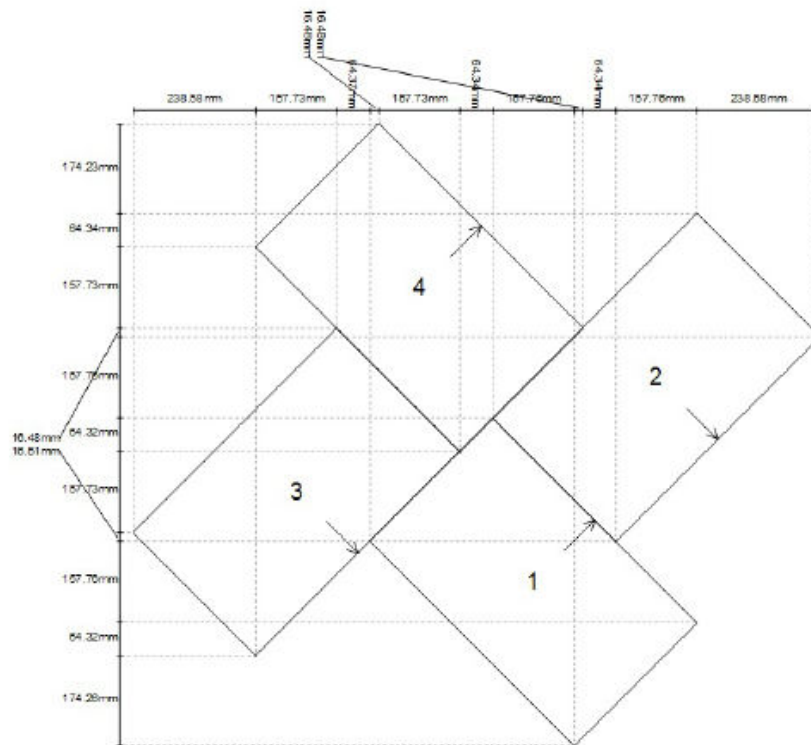

Display	Manufacturer	Model	Width	Height	Angle	Left	Top
1	HIKVISION	DS-D5024FC-A	560.50mm	337.40mm	45°	460.71mm	570.57mm
2	HIKVISION	DS-D5024FC-A	560.50mm	337.40mm	135°	699.28mm	174.23mm
3	HIKVISION	DS-D5024FC-A	560.50mm	337.40mm	135°	0.00mm	396.31mm
4	HIKVISION	DS-D5024FC-A	560.50mm	337.40mm	45°	238.61mm	0.00mm

3.4.3 Import a Layout File

You can import a layout file to the client for use or reference.

Steps

1. Click **Artistic Configuration** → **Display Configuration** .
2. Click  to open a layout file from the local computer.

3.5 Configure Mirroring Display

You can create a mirroring effect on a video wall by cascading two devices. Configure the same signal source for the two devices, and flip the input source of one display horizontally or vertically to achieve a mirroring effect.

Steps

Note

There are two types of mirroring: horizontal mirroring and vertical mirroring. The configuration methods are similar. This section uses an eight-display video wall as an example to describe how to configure mirroring on the video wall.

1. Click **Artistic Configuration** → **Display Configuration** , and add four displays to the video wall canvas.
2. Click **Artistic Configuration** → **Input Settings** , create input source 1 and configure an input source file for the input source.

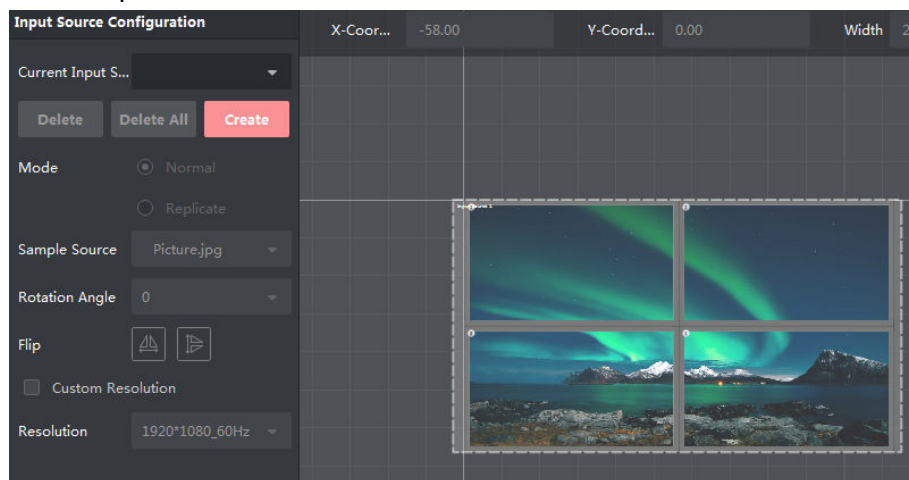



Figure 3-9 Configure Input Source 1

3. Repeat steps 1 and 2 to add another four displays, create input source 2, and configure the same input source file for the input source 2.
4. Click  to flip the image of the input source 2 horizontally.

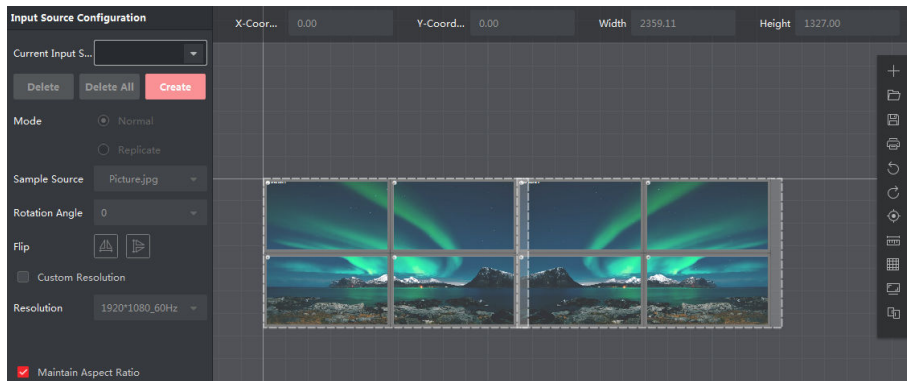

Figure 3-10 Configure Mirroring Mode

5. Click **Artistic Configuration** → **Device Topology** , draw a loop connection line for the two devices. Click, hold, and drag a line from the loop out interface of the first device to the loop in interface of the second device.

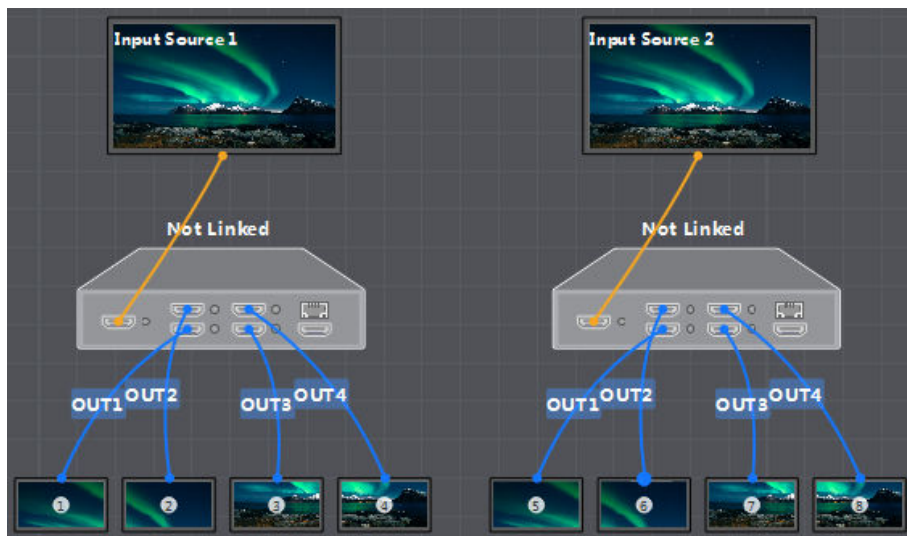

Figure 3-11 Device Topology (with Mirroring Not Configured)

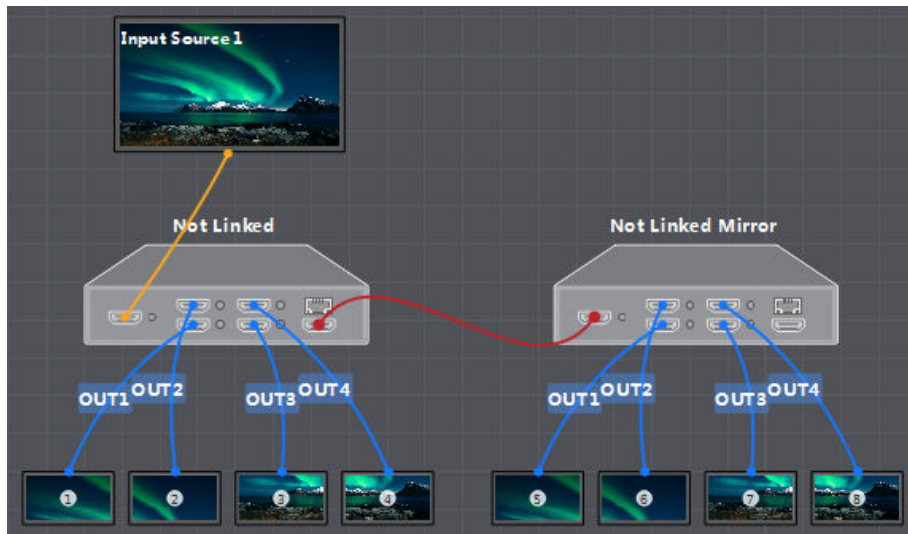

Figure 3-12 Device Topology (with Mirroring Configured)

6. After mirroring is configured, continue to finish other configurations, such as layout adjustment and device linking.

Chapter 4 Device Installation and Cabling

After finishing the design of your video wall solution on the client, you can install your devices and video wall according to the design.

4.1 Install Your Devices

Install Your Video Wall Controllers

Place your devices on flat surfaces such as a table, or on metal surfaces such as a video wall bracket or the rear of an LCD screen with the magnet feet on the bottom of your devices. Decide your installation way based on the actual scenario.

Install Your Video Wall

Install your video wall according to the video wall layout designed on the client. You can print the layout file for convenience.

4.2 Connect Cables

After installation is complete, you need to connect cables for your device, including the grounding cables, network cables, video and audio cables, serial cables, cascading cables, sync cables, and power cables.

4.2.1 Cable Connection Requirements

Different application scenarios require different cable connection. See the following table and figures for reference.

Table 4-1 Cable Connection Requirements

No.	Application Scenario	Cables Required
1	Signal splicing on video wall	<ul style="list-style-type: none">• Grounding cable• Network cable• Video and audio cables• Power cable
3	Cascading splicing of a signal	<ul style="list-style-type: none">• Grounding cable• Network cable• Video and audio cables• Loop cable

No.	Application Scenario	Cables Required
		<ul style="list-style-type: none"> • Sync cable • Power cable



Figure 4-1 Normal Signal Splicing on Video Wall

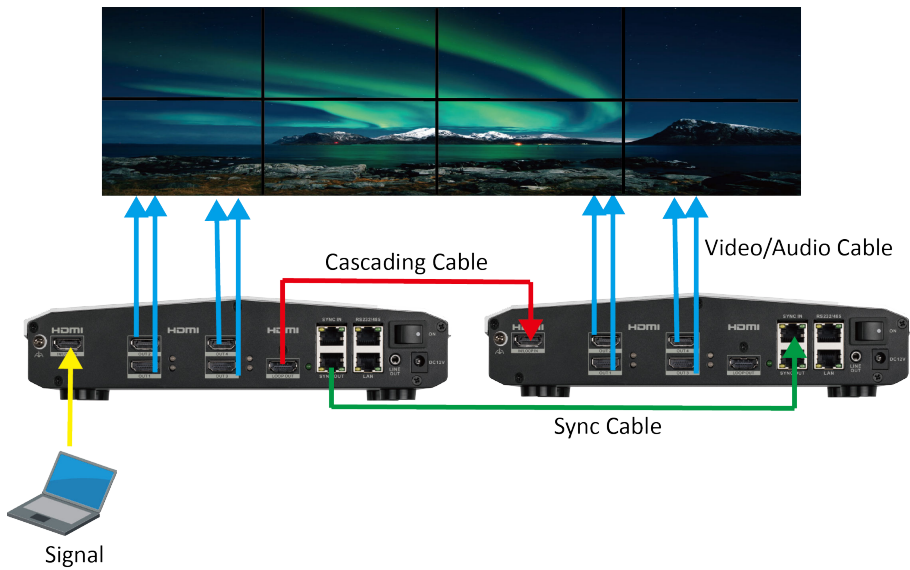

Figure 4-2 Cascading Splicing of a Signal

4.2.2 Cable Connection Description

See the following table for details about how to connect cables.

 **Note**

All cables mentioned in the following table require you to purchase separately.

Table 4-2 Cable Connection Description

No.	Cable	Connection Method
1	Grounding cable	<ol style="list-style-type: none"> 1. Use a Phillips screwdriver to remove the grounding screw on your device. 2. Use the Phillips screwdriver to connect one end of the grounding cable to the grounding terminal of your device and the other end to the grounding system.
2	Network cable	Connect the LAN interface of your device to the network using a network cable.
3	Video and audio cables	<ol style="list-style-type: none"> 1. Connect the HDMI input interfaces to input signal sources and the HDMI input interfaces to the video wall with HDMI cables. <p> Note</p> <ul style="list-style-type: none"> - Only HDMI 2.0 cables are supported. - If your site requires signal conversion cables, choose cables based on your actual needs. For the controllers, DP-HDMI cables support up to 4K@60 Hz input, DVI-HDMI cables support up to 4K@60 Hz input, and VGA-HDMI cables support up to 1080P@60 Hz. <ol style="list-style-type: none"> 2. Connect the line out interface to the audio device such as a loudspeaker with an audio cable.
4	Loop cable	<ol style="list-style-type: none"> 1. Connect the loop out interface of the master device to the loop in interface of one of the slave devices with an HDMI cable. 2. Connect the loop out interface of the slave device to the loop in interface of the next slave device with an HDMI cable. The rest can be done in the same manner.
5	Sync cable	<ol style="list-style-type: none"> 1. Connect the sync out interface of the first device to the sync in interface of the next device with a network cable. 2. Connect the sync out interface of the device to the sync in interface of the next device with a network cable. The rest can be done in the same manner.

No.	Cable	Connection Method
6	Serial cable	<p> Note</p> <p>The serial port is used for debugging only.</p> <ol style="list-style-type: none">1. Determine the serial cable order of the serial interface of your devices. The RS-232/485 serial interface of the device is an RJ45 type with eight feet, and feet 2 and 3 correspond to RX and TX of an RS-232 interface, and feet 4 and 5 correspond to RS-485+ and RS-485- of an RS-485 interface.2. Connect the serial interface of your video wall controller with that of an external device.
7	Power cable	<p>Choose either of the following ways to supply power to your device:</p> <ul style="list-style-type: none">• Connect the LAN interface of your device to the network with a network cable for power supply over PoE.• Turn on the power switch, and use the power adapter to connect the DC 12 V input interface to a socket.

Chapter 5 Device Configuration and Maintenance

You can perform device configuration and maintenance operations on the client, such as configuring device time and security services, changing the device password, searching and backing up operation logs, remotely restarting or upgrading devices, and restoring factory default settings.

5.1 Configure the Device Name and Device No.

A device name or device No. identifies a device from other devices. You can customize the name or No. as needed.

Steps

1. Click **Maintenance and Management** → **Device Management** , select the desired device in the list and click **Remote Configuration** on the **Operation** column.
2. Click **System** → **General** .
3. Change the **Device Name** or **Device No.** as needed.
4. Click **Save**.

5.2 Configure Device Time

If your device time is incorrect, set the time zone or manually synchronize time to correct the time.

Steps

1. Click **Maintenance and Management** → **Device Management** , select the desired device in the list and click **Remote Configuration** on the **Operation** column.
2. Click **System** → **Time** .

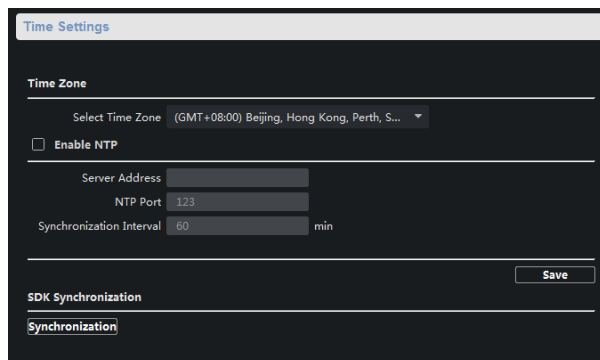

Figure 5-1 Configure Device Time

3. Select a time zone where your device is located.
4. **Optional:** To synchronize your device with other devices on the same network, enable **NTP** and configure **Server Address**, **NTP Port**, and **Synchronization Interval**.

5. Click **Save**.
6. **Optional:** To manually synchronize time, click **Synchronization**.

5.3 Reset Device Password

If you forget your device password, just reset your password by exporting and importing a GUID file.

Steps

1. Click **Maintenance and Management** → **Device Management**, and select the desired device from the online device list and click **Reset Password**.

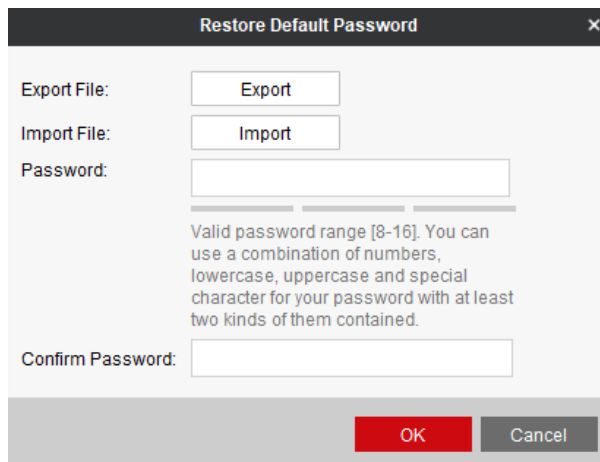

The screenshot shows a dialog box titled "Restore Default Password" with a close button (X) in the top right corner. It contains the following elements:

- Export File:** A text label followed by an "Export" button.
- Import File:** A text label followed by an "Import" button.
- Password:** A text input field.
- Confirm Password:** A text input field.
- Instructions:** A paragraph of text: "Valid password range [8-16]. You can use a combination of numbers, lowercase, uppercase and special character for your password with at least two kinds of them contained."
- Buttons:** "OK" (red) and "Cancel" (grey) buttons at the bottom right.

Figure 5-2 Reset Password

2. Click **Export** to export the GUID file in XML format to your local computer.
3. Provide the GUID file to your technical support engineer for generating a key file.
4. After receiving the key file, click **Import** to import the file into your device.
Your device password is cleared for you to set a new one.
5. Enter a new password and confirm the password.

Caution

We highly recommend you to create a strong password of your own choosing (using a minimum of 8 characters, including at least three kinds of following categories: upper case letters, lower case letters, numbers, and special characters) in order to increase the security of your product. And we recommend you reset your password regularly, especially in the high security system, resetting the password monthly or weekly can better protect your product.

6. Click **OK**.

5.4 View Device Information

You can view device information such as the device type, serial No., or version No. on the client.

Steps

1. Click **Maintenance and Management → Device Management** , select the desired device in the list and click **Remote Configuration** on the **Operation** column.
2. Click **System → Device Information** to view device information such as the device type, serial No., or version No.

5.5 Configure Serial Parameters

If you want to debug your device over the RS-232/485 serial port, you can configure serial parameters on the client as needed. The default serial port type is RS-232, and you can change it to RS-485 as needed.

Steps

1. Click **Maintenance and Management → Device Management** , select the desired device in the list and click **Remote Configuration** on the **Operation** column.
2. Click **System → Serial Port Configuration** .

Serial Port Parameters	
Serial Port No.	COM1
Serial Port Type	RS232
Working Mode	Console
Baud Rate	115.2k
Data Bit	8
Stop Bit	1
Parity Type	None
Flow Control Type	None
Protocol Type	MatrixProtocol
Variable	
Save	

Figure 5-3 Configure Serial Parameters

3. Configure serial parameters, including **Serial Port Type**, **Baud Rate**, **Data Bit**, **Stop Bit**, **Parity Type**, and **Flow Control Type**.
4. Click **Save**.

5.6 Configure Security Parameters

Configure security parameters as needed.

Steps

1. Click **Maintenance and Management → Device Management** , select the desired device in the list and click **Remote Configuration** on the **Operation** column.
2. Click **System → Security** .
3. Enable or disable **SSH** as required. SSH (Secure Shell) is a protocol to ensure security of remote login. SSH is disabled by default.
4. Enable or disable **SADP** as required. When SADP is enabled, your devices can be automatically found by the client. SADP is enabled by default.
5. Click **Save**.

5.7 Import and Export a Configuration File

If you have multiple devices on site, you can export the configuration file of a finished device and import the file to other devices to save time.

Steps

1. Click **Maintenance and Management → Device Management** , select the desired device in the list and click **Remote Configuration** on the **Operation** column.
2. Click **System → System Maintenance** .
3. Export or import a configuration file.
 - Click **Import Configuration File** to import a configuration file, enter the password, and click **OK**.
 - Click **Export Configuration File** to export the configuration file, set a password, and click **OK**.



Caution

We highly recommend you to create a strong password of your own choosing (using a minimum of 8 characters, including at least three kinds of following categories: upper case letters, lower case letters, numbers, and special characters) in order to increase the security of your product. And we recommend you reset your password regularly, especially in the high security system, resetting the password monthly or weekly can better protect your product.

5.8 Query and Back Up Logs

You can query or back up exception or operation logs for troubleshooting.

Steps

1. Click **Maintenance and Management → Device Management** , select the desired device in the list and click **Remote Configuration** on the **Operation** column.

2. Click **System** → **Log Query** .
3. Set the **Search Mode**. **Major Type**, **Minor Type**, **Start Time**, and **End Time** are available.
4. Click **Search** to search logs. Click **Backup** to back up the logs as needed.

5.9 Restore Default Parameters

You can restore your device to factory default settings as needed, for example, when your device encounters a fault that is difficult to resolve.

Steps

1. Click **Maintenance and Management** → **Device Management** , select the desired device in the list and click **Remote Configuration** on the **Operation** column.
2. Click **System** → **System Maintenance** .
3. Restore partial default parameters or all default parameters by clicking **Restore Default Settings** or **Restore All**.



Caution

- Clicking **Restore Default Settings** will restore all parameters to factory settings except IP configuration.
 - Click **Restore All** will clear all parameters and restore the parameters to factory settings.
 - You are recommended to export the configuration file first before restoring parameters.
-

5.10 Restart a Device Remotely

You can restart your device remotely on the client for troubleshooting.

Steps

1. Click **Maintenance and Management** → **Device Management** , select the desired device in the list and click **Remote Configuration** on the **Operation** column.
2. Click **System** → **System Maintenance** .
3. Click **Reboot**.

5.11 Upgrade a Device Remotely

You can upgrade your device remotely on the client.

Steps

1. Click **Maintenance and Management** → **Device Management** , select the desired device in the list and click **Remote Configuration** on the **Operation** column.
2. Click **System** → **System Maintenance** .
3. In the **Remote Upgrade** area, select and import the upgrade file and click **Upgrade**.

Chapter 6 User Management

The device has only one admin user. You can change the password on the client.

Before You Start

Steps

1. Click **Maintenance and Management** → **Account Management** .
2. Click **Change Password**.
3. Enter the old password, new password and confirm the password.
4. Click **OK**.



Caution

The password strength of the device can be automatically checked. We highly recommend you change the password of your own choosing (using a minimum of 8 characters, including at least three kinds of following categories: upper case letters, lower case letters, numbers, and special characters) in order to increase the security of your product. And we recommend you change your password regularly, especially in the high security system, changing the password monthly or weekly can better protect your product.

Proper configuration of all passwords and other security settings is the responsibility of the installer and/or end-user.

Chapter 7 Operation and Maintenance

You can perform maintaining operations in the menu to ensure a smooth and convenient usage of the client.

Click  in the upper-right corner, and then click **System/Tool** to perform the following operations.

Import/Export Configuration File

You can import configuration files from local PC to the client if needed, and vice versa.

Skin

Change the skin of the client, including bright-color series and black-color series.

Batch Time Sync

Synchronize selected devices' time with your PC time.

Message Queue

After configuring email linkage, the triggered event(s) will be displayed here. Select an event and cancel sending the an email to the receiver.

Chapter 8 Get More Information

Scan the following QR code to get more information about the operation and maintenance.





See Far, Go Further