

DS-2DE7A225IW-AEB(T5) 2 MP 25 × IR Network Speed Dome

AcuSense



Hikvision DS-2DE7A225IW-AEB(T5) 2 MP 25 × IR Network Speed Dome adopts 1/2.8" progressive scan CMOS chip. With the 25 × optical zoom lens, the camera offers more details over expansive areas.

This series of cameras can be widely used for wide ranges of high-definition, such as the rivers, roads, railways, airports, squares, parks, scenic spots, and venues, etc.

Empowered by deep learning algorithms, Hikvision AcuSense technology brings human and vehicle targets classification alarms to front- and back-end devices. The system focuses on human and vehicle targets, vastly improving alarm efficiency and effectiveness.

- 1/2.8" progressive scan CMOS
- High quality imaging with 2 MP resolution, up to 60 fps
- Excellent low-light performance with powered-by-DarkFighter technology
- Audio visual alarm: The white flashing light and audible warning can be triggered by certain events
- 25 × optical zoom and 16 × digital zoom provide close up views over expansive areas
- Expansive night view with up to 200 m IR distance
- Focuses on human and vehicle targets classification based on deep learning
- Face capture: Up to 5 faces captured at the same time



▪ DORI

The DORI (detect, observe, recognize, identify) distance gives the general idea of the camera ability to distinguish persons or objects within its field of view. It is calculated based on the camera sensor specification and the criteria given by EN 62676-4: 2015.

| DORI | Detect | Observe | Recognize | Identify |
|-----------------|----------------------|---------------------|---------------------|--------------------|
| Definition | 25 px/m | 63 px/m | 125 px/m | 250 px/m |
| Distance (Tele) | 1600.0 m (5249.3 ft) | 634.9 m (2083.1 ft) | 320.0 m (1049.9 ft) | 160.0 m (524.9 ft) |

▪ Specification

| Camera | |
|------------------------|---|
| Image Sensor | 1/2.8" progressive scan CMOS |
| Max. Resolution | 1920 × 1080 |
| Min. Illumination | Color: 0.005 Lux @ (F1.6, AGC ON), B/W: 0.001 Lux@(F1.6, AGC ON), 0 Lux with IR |
| Shutter Speed | 1/1 s to 1/30000 s |
| Slow Shutter | Yes |
| Day & Night | IR cut filter |
| Zoom | 25 × optical, 16 × digital |
| Lens | |
| Focal Length | 4.8 mm to 120 mm |
| Zoom Speed | Approx. 3.6 s |
| FOV | Horizontal field of view: 57.6° to 2.5° (wide-tele), Vertical field of view: 34.4° to 1.4° (wide-tele), Diagonal field of view: 64.5° to 2.9° (wide-tele) |
| Aperture | Max. F1.6 |
| Focus | Auto, semi-auto, manual |
| Illuminator | |
| Supplement Light Range | IR Distance: up to 200 m |
| Supplement Light Type | IR |
| PTZ | |
| Movement Range (Pan) | 360° |
| Movement Range (Tilt) | -15° to 90° (auto flip) |
| Pan Speed | Pan speed: configurable from 0.1° to 160°/s; preset speed: 240°/s |
| Tilt Speed | Tilt speed: configurable from 0.1° to 120°/s, preset speed 200°/s |
| Proportional Pan | Yes |
| Presets | 300 |
| Patrol Scan | 8 patrols, up to 32 presets for each patrol |
| Pattern Scan | 4 pattern scans |
| Power-off Memory | Yes |
| Park Action | Preset, patrol scan, pattern scan, auto scan, tilt scan, random scan, frame scan, panorama scan |
| 3D Positioning | Yes |
| PTZ Status Display | Yes |
| Preset Freezing | Yes |

| | |
|-----------------------------|---|
| Scheduled Task | Preset, pattern scan, patrol scan, auto scan, tilt scan, random scan, frame scan, panorama scan, dome reboot, dome adjust, aux output |
| Video | |
| Main Stream | 50 Hz: 50 fps (1920 × 1080, 1280 × 960, 1280 × 720) 60 Hz: 60 fps (1920 × 1080, 1280 × 960, 1280 × 720) *High frame rate is supported under certain settings. |
| Sub-Stream | 50 Hz: 25 fps (704 × 576, 640 × 480, 352 × 288); 60 Hz: 30 fps (704 × 480, 640 × 480, 352 × 240) |
| Third Stream | 50 Hz: 25 fps (1920 × 1080, 1280 × 960, 1280 × 720, 704 × 576, 640 × 480, 352 × 288); 60 Hz: 30 fps (1920 × 1080, 1280 × 960, 1280 × 720, 704 × 480, 640 × 480, 352 × 240) |
| Video Compression | Main stream: H.265+/H.265/H.264+/H.264 Sub-stream: H.265/H.264/MJPEG Third stream: H.265/H.264/MJPEG |
| Video Bit Rate | 32 kbps to 16384 kbps |
| H.264 Type | Baseline Profile/Main Profile/High Profile |
| H.265 Type | Main Profile |
| Scalable Video Coding (SVC) | H.264 and H.265 encoding |
| Region of Interest (ROI) | 8 fixed regions for each stream |
| Audio | |
| Audio Compression | G.711alaw, G.711ulaw, G.722.1, G.726, MP2L2, PCM |
| Audio Bit Rate | 64 Kbps (G.711)/16 Kbps (G.722.1)/16 Kbps (G.726)/32-192 Kbps (MP2L2) |
| Audio Sampling Rate | 8 kHz/16 kHz/32 kHz/48 kHz |
| Environment Noise Filtering | Yes |
| Network | |
| Network Storage | NAS (NFS, SMB/CIFS), auto network replenishment (ANR) |
| Protocols | IPv4/IPv6, HTTP, HTTPS, 802.1x, QoS, FTP, SMTP, UPnP, SNMP, DNS, DDNS, NTP, RTSP, RTCP, RTP, TCP/IP, UDP, IGMP, ICMP, DHCP, PPPoE, Bonjour, Websocket, Websockets |
| API | Open Network Video Interface (Version 19.12, Profile S, Profile G, Profile T), ISAPI, SDK, ISUP |
| Simultaneous Live View | Up to 20 channels |
| User/Host | Up to 32 users, 3 user levels: administrator, operator, and user |
| Security | Password protection, complicated password, HTTPS encryption, 802.1X authentication (EAP-TLS, EAP-LEAP, EAP-MD5), watermark, IP address filter, basic and digest authentication for HTTP/HTTPS, RTP/RTSP over HTTPS, control timeout settings, security audit log, TLS 1.2, TLS 1.3, host authentication (MAC address) |
| Client | iVMS-4200, HikCentral Pro, Hik-Connect |
| Web Browser | IE11, Chrome 57+, Firefox 52+, Safari 11+ |
| Image | |
| Day/Night Switch | Day, Night, Auto, Schedule |
| Image Enhancement | BLC, HLC, 3D DNR |
| Wide Dynamic Range (WDR) | 120 dB |
| Defog | Digital defog |
| Regional Exposure | Yes |
| Regional Focus | Yes |

| | |
|-------------------------------|---|
| Image Settings | Saturation, brightness, contrast, sharpness, gain, and white balance adjustable by client software or web browser |
| Privacy Mask | 24 programmable polygon privacy masks, mask color or mosaic configurable |
| SNR | > 52 dB |
| Interface | |
| Ethernet Interface | 1 RJ45 10M/100M self-adaptive Ethernet port |
| On-board Storage | Built-in memory card slot, support microSD/SDHC/SDXC card, up to 256 GB |
| Alarm | 2 inputs, 1 output |
| Audio | 1 input (line in), max. input amplitude: 2-2.4 vpp, input impedance: 1 k Ω \pm 10%; 1 output (line out), line level, output impedance: 600 Ω |
| Reset | Yes |
| Built-in Speaker | 1 built-in speaker with effective distance reaching max. 30 meters |
| Event | |
| Basic Event | Motion detection, video tampering alarm, exception, alarm input and output |
| Smart Event | Line crossing detection, intrusion detection, region entrance detection, region exiting detection, unattended baggage detection, object removal detection, audio exception detection |
| Smart Tracking | Manual tracking, auto-tracking |
| Alarm Linkage | Upload to FTP/NAS/memory card, notify surveillance center, send email, trigger alarm output, trigger recording, audible warning, white light flashing, and PTZ actions (such as preset, patrol scan, pattern scan) |
| Deep Learning Function | |
| Face Capture | Detects up to 5 faces simultaneously. Supports detecting, capturing, grading, selecting of face in motion, and output the best face picture of the face |
| Perimeter Protection | Line crossing, intrusion, region entrance, region exiting Support alarm triggering by specified target types (human and vehicle) |
| General | |
| Power | 24 VAC, max. 42 W (including max. 18 W for IR and max. 10 W for heater); Hi-PoE |
| Operating Condition | -30 $^{\circ}$ C to 65 $^{\circ}$ C (-22 $^{\circ}$ F to 149 $^{\circ}$ F). Humidity 90% or less (non-condensing) |
| Demist | Yes |
| Material | ADC12 |
| Dimension | \varnothing 220 mm \times 363.3 mm (\varnothing 8.66" \times 14.3") |
| Weight | Approx. 5 kg (11.03 lb.) |
| Approval | |
| Protection | IP66 (IEC 60529-2013), IK10 (excluding glass window), TVS 6000V lightning protection, surge protection and voltage transient protection |
| EMC | FCC SDoC (47 CFR Part 15, Subpart B); CE-EMC (EN 55032: 2015, EN 61000-3-2: 2019, EN 61000-3-3: 2013, EN 50130-4: 2011 +A1: 2014); RCM (AS/NZS CISPR 32: 2015); IC VoC (ICES-003: Issue 6, 2019); KC (KN 32: 2015, KN 35: 2015) |

| | |
|-------------|---|
| Safety | <ul style="list-style-type: none"> UL (UL 62368-1); CB (IEC 60950-1:2005 + Am 1:2009 + Am 2:2013, IEC 62368-1:2014); CE-LVD (EN 62368-1:2014+A11:2017); BIS (IS 13252(Part 1):2010+A1:2013+A2:2015); LOA (SANS IEC60950-1) |
| Environment | <ul style="list-style-type: none"> CE-RoHS (2011/65/EU); WEEE (2012/19/EU); Reach (Regulation (EC) No 1907/2006) |

▪ Available Model

DS-2DE7A225IW-AEB(T5)

▪ Typical Application

Hikvision products are classified into three levels according to their anti-corrosion performance. Refer to the following description to choose for your using environment.

This model has NO SPECIFIC PROTECTION.

| Level | Description |
|------------------------|--|
| Top-level protection | Hikvision products at this level are equipped for use in areas where professional anti-corrosion protection is a must. Typical application scenarios include coastlines, docks, chemical plants, and more. |
| Moderate protection | Hikvision products at this level are equipped for use in areas with moderate anti-corrosion demands. Typical application scenarios include coastal areas about 2 kilometers (1.24 miles) away from coastlines, as well as areas affected by acid rain. |
| No specific protection | Hikvision products at this level are equipped for use in areas where no specific anti-corrosion protection is needed. |

▪ **Dimension**

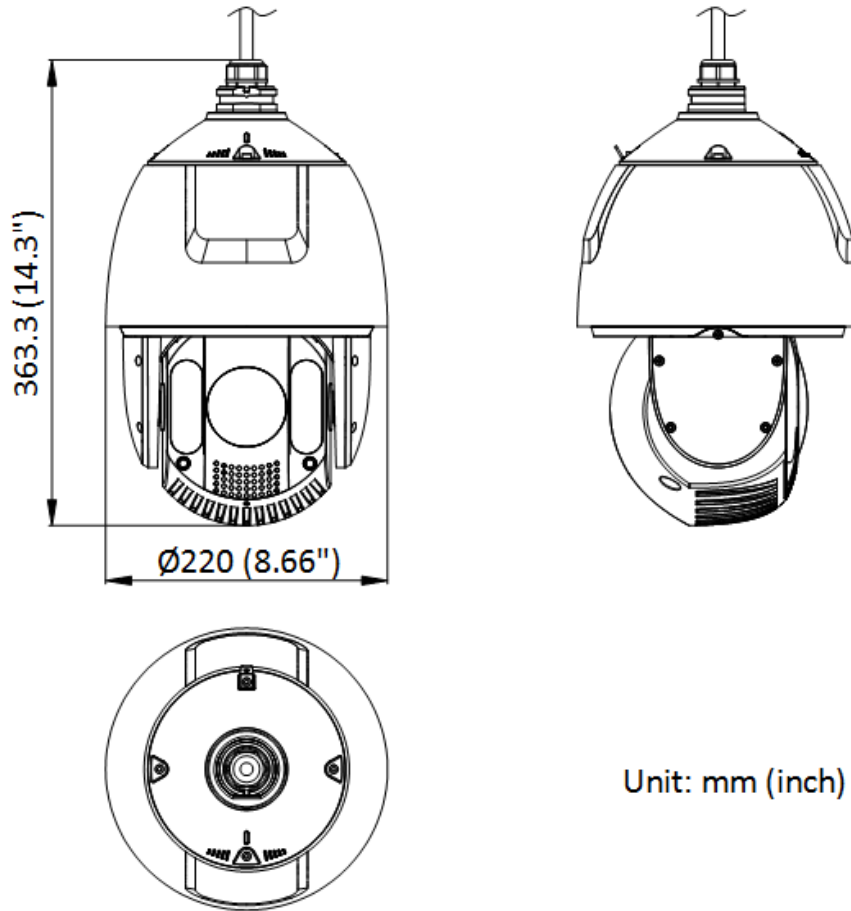

▪ **Accessory**















▪ **Included**

DS-1602ZJ

Wall mount



▪Optional

| | | | | |
|---|---|---|---|---|
| DS-1604ZJ-BOX-CORNER | DS-1660ZJ | DS-1604ZJ-box | DS-1619ZJ | DS-1663ZJ |
|  |  |  |  |  |
| DS-1667ZJ | DS-1662ZJ | DS-1673ZJ | DS-1682ZJ | DS-1681ZJ-2 |
|  |  |  |  |  |
| DS-1604ZJ | DS-1604ZJ-BOX-POLE | DS-1681ZJ | DS-1661ZJ | DS-1100KI |
|  |  |  |  |  |

*DS-1673ZJ should be used with DS-1661ZJ or DS-1662ZJ.

Distributed by

**HIKVISION®****Headquarters**

No.555 Qianmo Road, Binjiang District,
Hangzhou 310051, China
T +86-571-8807-5998
overseasbusiness@hikvision.com

Hikvision USA
T +1-909-895-0400
sales.usa@hikvision.com

Hikvision Australia
T +61-2-8599-4233
salesau@hikvision.com

Hikvision India
T +91-22-28469900
sales@pramahikvision.com

Hikvision Canada
T +1-866-200-6690
sales.canada@hikvision.com

Hikvision Thailand
T +662-275-9949
sales.thailand@hikvision.com

Hikvision Europe
T +31-23-5542770
sales.eu@hikvision.com

Hikvision Italy
T +39-0438-6902
info.it@hikvision.com

Hikvision Brazil
T +55 11 3318-0050
Latam.support@hikvision.com

Hikvision Turkey
T +90 (216)521 7070- 7074
sales.tr@hikvision.com

Hikvision Malaysia
T +601-7652-2413
sales.my@hikvision.com

Hikvision UK & Ireland
T +01628-902140
sales.uk@hikvision.com

Hikvision South Africa
Tel: +27 (10) 0351172
sale.africa@hikvision.com

Hikvision France
T +33(0)1-85-330-450
info.fr@hikvision.com

Hikvision Kazakhstan
T +7-727-9730667
nikia.panfilov@hikvision.ru

Hikvision Vietnam
T +84-974270888
sales.vt@hikvision.com

Hikvision UAE
T +971-4-4432090
salesme@hikvision.com

Hikvision Singapore
T +65-6684-4718
sg@hikvision.com

Hikvision Spain
T +34-91-737-16-55
info.es@hikvision.com

Hikvision Tashkent
T +99-87-1238-9438
uzb@hikvision.ru

Hikvision Hong Kong
T +852-2151-1761
info.hk@hikvision.com

Hikvision Russia
T +7-495-669-67-99
saleru@hikvision.com

Hikvision Korea
T +82-(0)31-731-8817
sales.korea@hikvision.com

Hikvision Poland
T +48-22-460-01-50
info.pl@hikvision.com

Hikvision Indonesia
T +62-21-2933759
Sales.Indonesia@hikvision.com

Hikvision Colombia
sales.colombia@hikvision.com