



TAKE TOTAL CONTROL OF
VEHICLE ACCESS
**SMART PARKING ACCESS
SOLUTION**

 smart solution **2.0**

WITH HIKVISION AS YOUR INTEGRATION PARTNER, YOU WILL STAND ON A SOLID FOUNDATION

RAPID GROWTH

Hikvision is the world's leading supplier of video surveillance products and solutions, featuring the industry's strongest R&D workforce and state-of-the-art manufacturing facilities. In just 15 years, Hikvision has developed from being a single-product provider to a complete product and solution provider and a global market leader.

GLOBAL REACH

- 33 Regional subsidiaries
- 57% of Employees in International Business Centre are locals

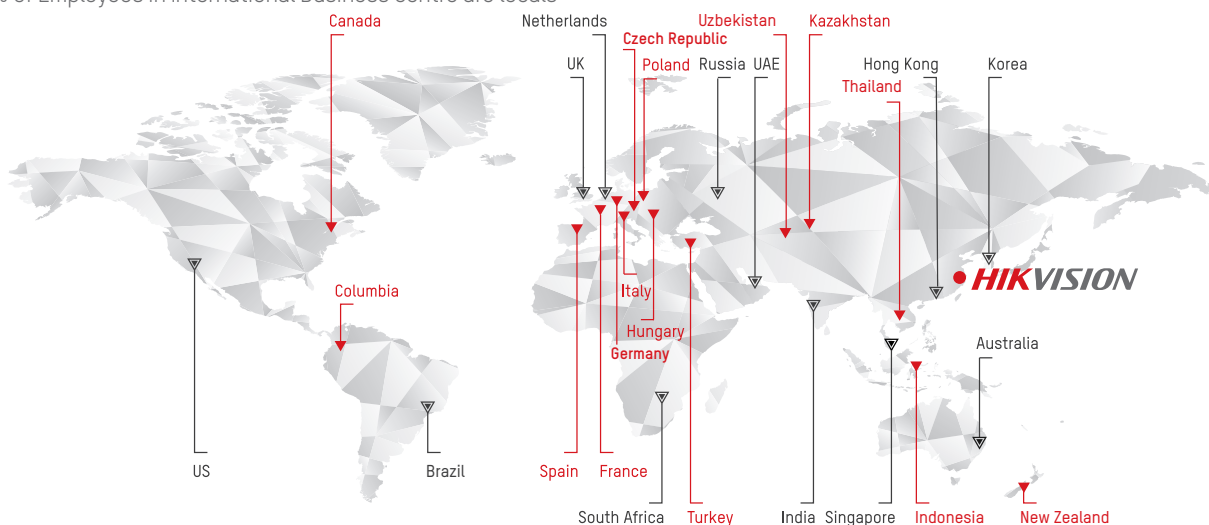

PARKING ACCESS SOLUTION APPLICATIONS

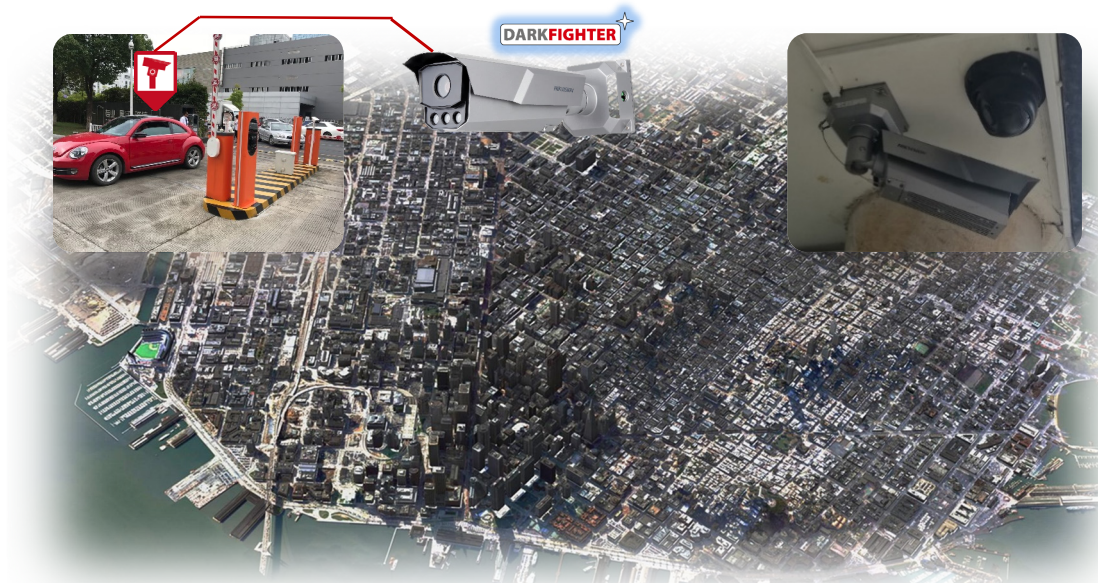

PARKING ENTRANCE

SMART SOLUTION FOR ACCESS

- Reduced administrative effort and costs at the entrance & exit
- Non-stop passing through the barrier with the authorisation via ANPR
- Ensures 24/7 surveillance of entire parking areas
- Captures reliable, high-definition footage for post-event investigation



Parking area

Wide open area, requires HD surveillance for capture of details of parking-related events.

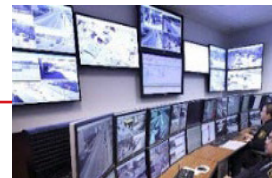
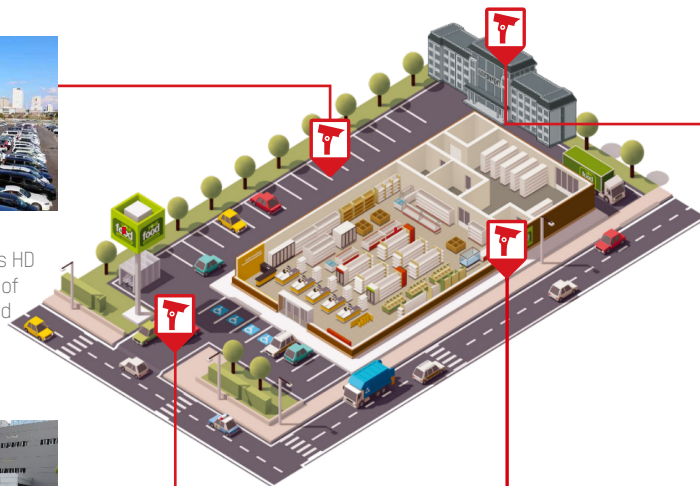

Management Centre

Efficient and flexible management of customer's vehicle and parking place resource. Quick location of a specific vehicle's parking event from historical mass data for post event investigation.

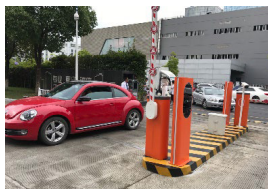

Security booth

Clear visibility in strong sunlight conditions, VIP customer vehicle auto release, Abnormal vehicle entrance event quick response.



Perimeter

Keep the wide perimeter secure and stay vigilant 7*24 hour to unexpected event.

ENTRANCE & EXIT



ANPR, Access Management, Monitoring

- Built-in License Plate Recognition algorithm
- Black/Whitelist configuration and comparison in the camera
- Barrier control by the camera

DarkFighter® and True WDR technologies, as well as optional IR, ensure crisp, clear images and video of each vehicle for recognition and recording.





Barrier Trigger Radar & Anti-fall Radar

- Easier installation and maintenance – no need to remove pavement for the sensing coil
- Extra safety – both vehicles and pedestrians benefit from protection
- Robust design – free from environmental influences including light, dust, rain and snow
- Trigger radar detects approaching vehicle and triggers ANPR and barrier
- Safety sensor ensures the barrier remains open when passageway is not clear

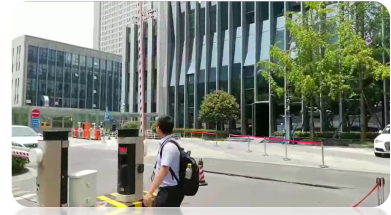
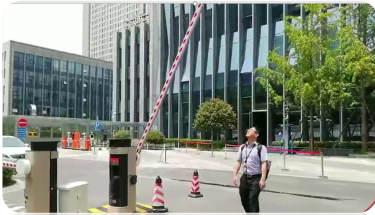

Outdoor LED Display Panel Integration

- By integrating an LED display panel at the entrance, all available parking resources and information can be easily displayed for customers
- Show the vehicle plate recognition result for drivers, to indicate driver related information when barrier doesn't open and help driver to acknowledge the vehicle plate clearly



Automated Model

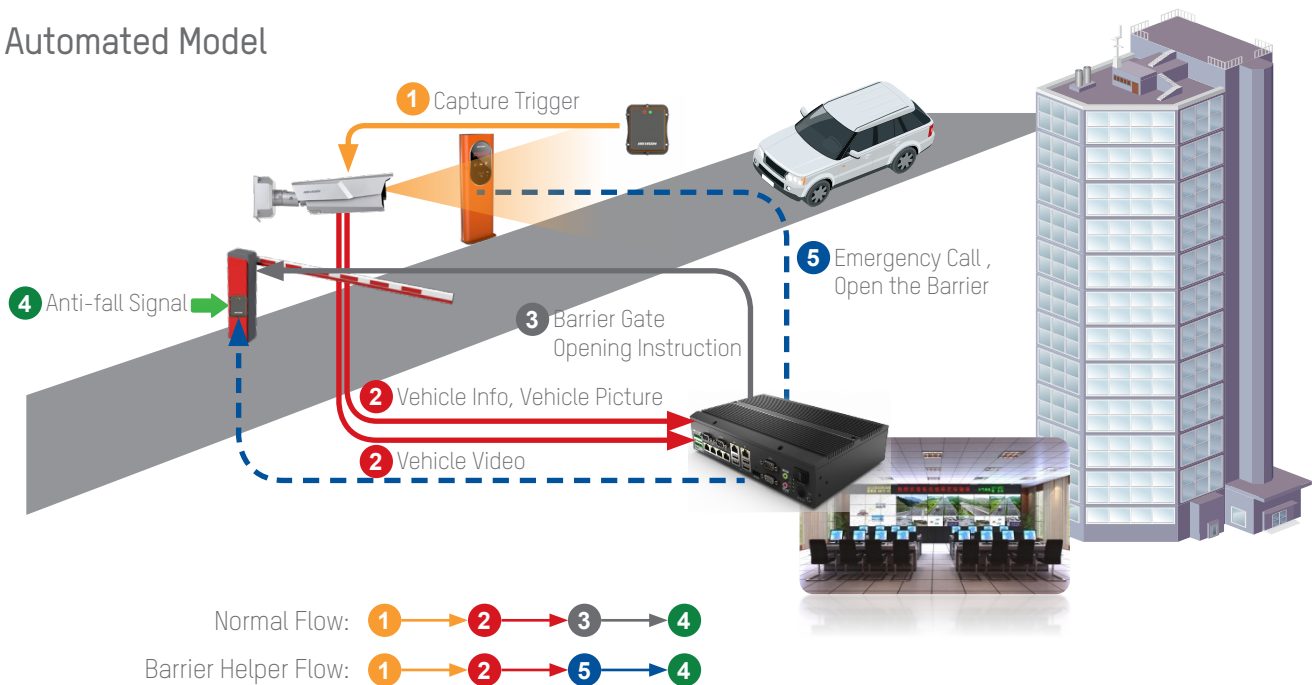

PARKING ENTRANCE

Managed Model

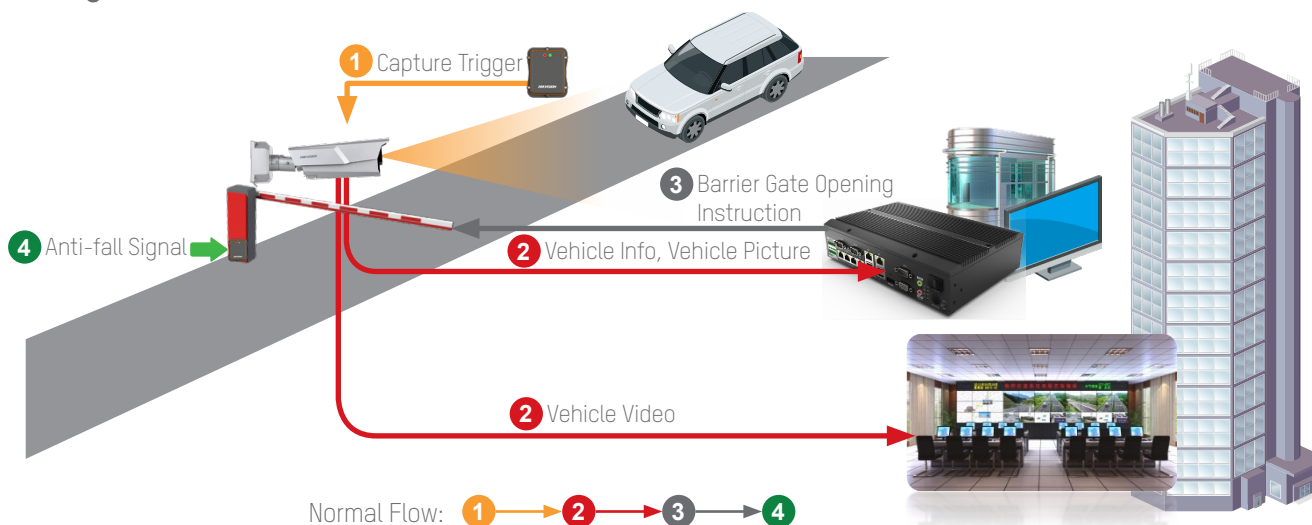

ANPR Camera

- Automatic number plate recognition
- Upload vehicle plate information and picture to back-end device
- Black/white list management and barrier control off-line

Sensing radar

- Easier installation and maintenance
- Extra safety - both vehicles and pedestrians benefit from protection
- Robust design - Free from environmental influences including light, dust, rain and snow

Two radars for each access lane:

- Trigger radar detects approaching vehicle and triggers ANPR and barrier
- Safety sensor ensures the barrier remains open when passageway is not clear

Recommendation 1

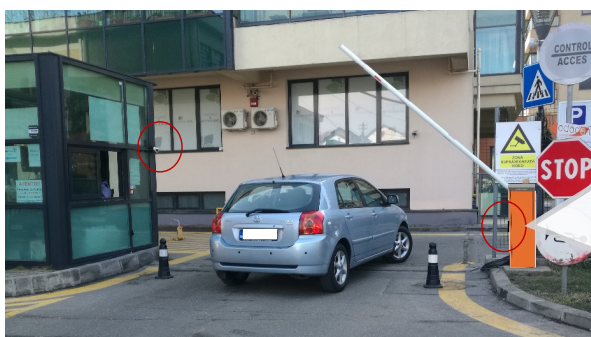

ANPR NVR

- Vehicle number plate & vehicle picture storage
- Vehicle's passing-through video clip storage
- Black/white list management, alarm notification (support up to 10,000 plate numbers)
- Simple road barrier control via I/O interface, no manual correction, no manual barrier control

Advantages

Easy-to-use, a true system which is also simple to deploy. Ideal for a small entrance control system.

Recommendation 2

Access Control Terminal

- Vehicle number plate & vehicle picture storage
- Vehicle's passing-through video clip storage
- Black/white list management, alarm notification (support up to 5,000 plate numbers)
- Special parking alarming, including overtime stay, list expiration check, unauthorised period access etc.
- Road barrier control, support error correction, auto/manual barrier control, vehicle auto-matching etc.
- Simple road barrier control via I/O interface, number plate manual correction, number plate manual barrier control
- Available parking lots counting, support data output to 3rd party LED indicators
- Support data analysis, including vehicle traffic flow report, average parking time report etc.



Advantages

- A comprehensive system, dedicated entrance control terminal with rich interfaces to connect external devices, ideal for a mid-large sized location with video surveillance, management, reporting and multi-sites deployment. Customisation support to meet more business requirements.

PARKING AREA & PERIMETER MONITORING



Large parking lots require vigilant management to ensure the flow of traffic and HD footage and to resolve disputes when accidents happen. Hikvision's solution provides Smart features to keep parking areas operating efficiently and visitors happy.

DarkFighter® cameras: Parking area lighting can be a tremendous challenge, but Hikvision's DarkFighter® camera captures sharp color images – even at low light levels.

PARKING ENTRANCE

PARKING ACCESS SOLUTION ARCHITECTURE

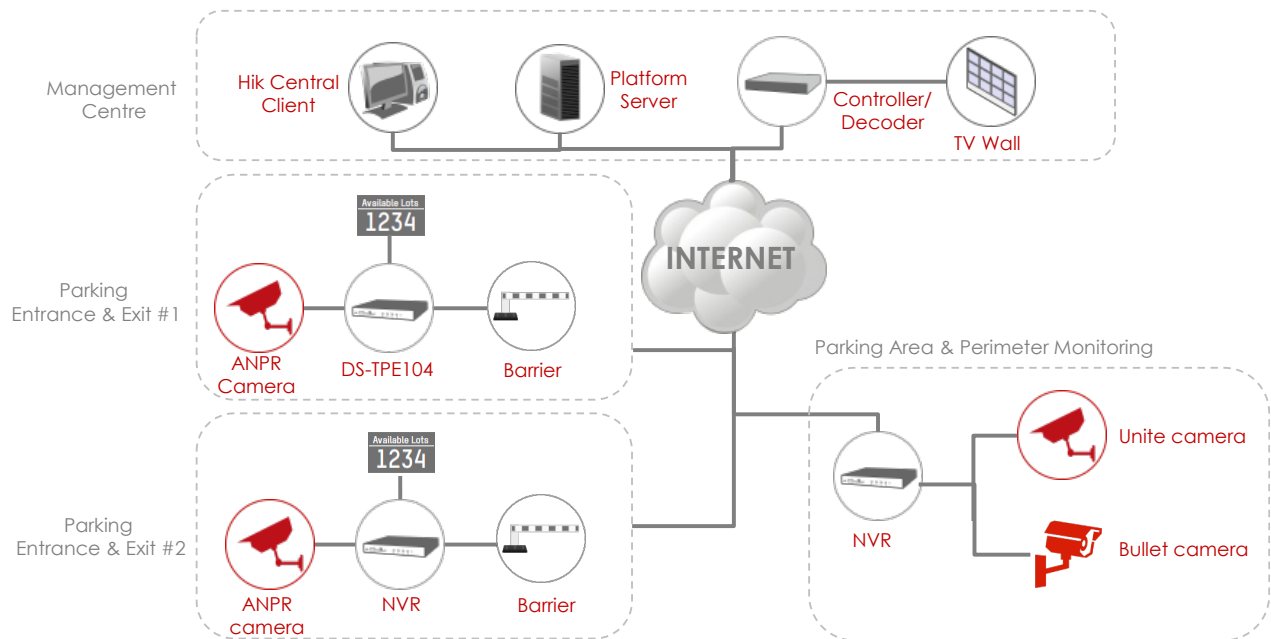

PARKING ACCESS SOLUTION APPLICATIONS

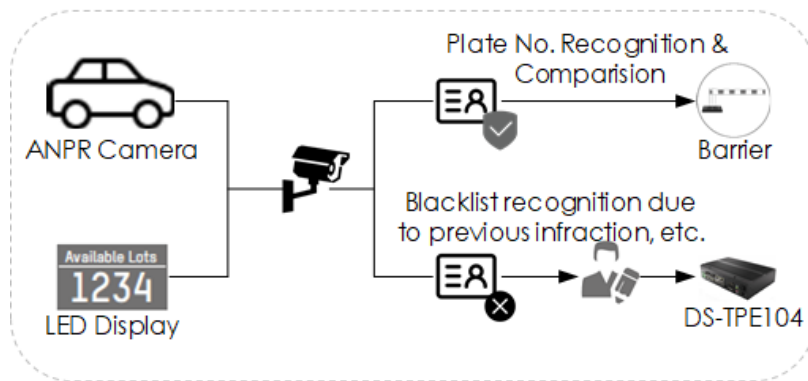

- Automatic Number Plate Recognition – High-definition image captured and video stored locally in Entrance & Exit control terminal
- Automatic barrier can be opened for whitelisted vehicles. The barrier can remain in place and alarm sent for blacklisted vehicles
- Plate number can be manually corrected by management personnel to avoid congestion in the entrance & exit in case of recognition failure
- Black/whitelists can be modified easily at each guard office according to user authority
- Smart vehicle-access event searching based on time or full or partial plate number
- Local HDMI/VGI output support
- LED displays the available lot information in real time to notify customers of open stalls, hours of operation, etc.

KEY TECHNOLOGY

More efficient plate matching



VS

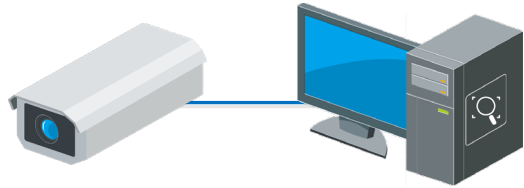

Front-end match

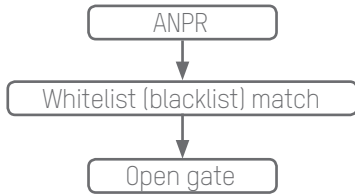

<

Back-end match

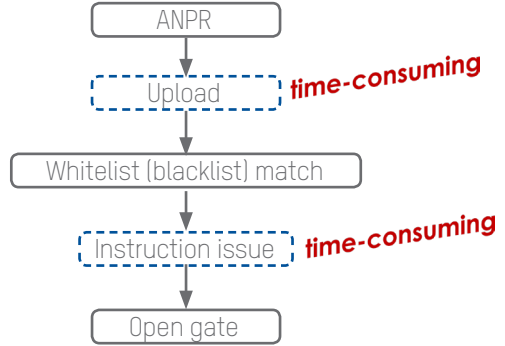

More efficient and lower risk of car damage



VS



Free-flow

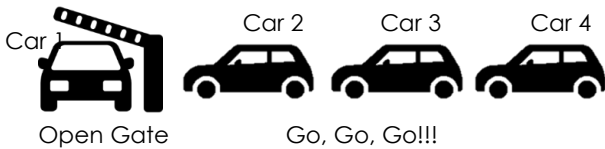

<

Stop & Go, one by one

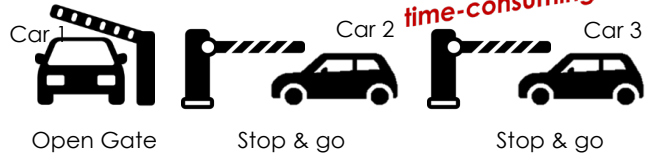

3 Anti-Glare

High night image quality in spite of high beam lights

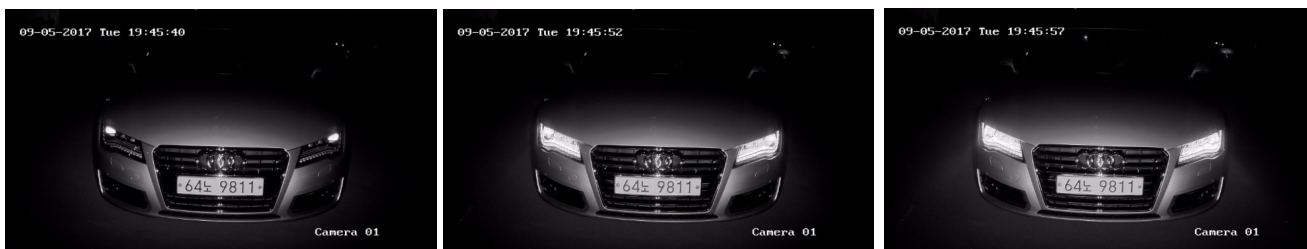

No lights

Low beam lights

High beam lights

4 Open Protocol for integration

Provide abundant data through ISAPI of different product combinations

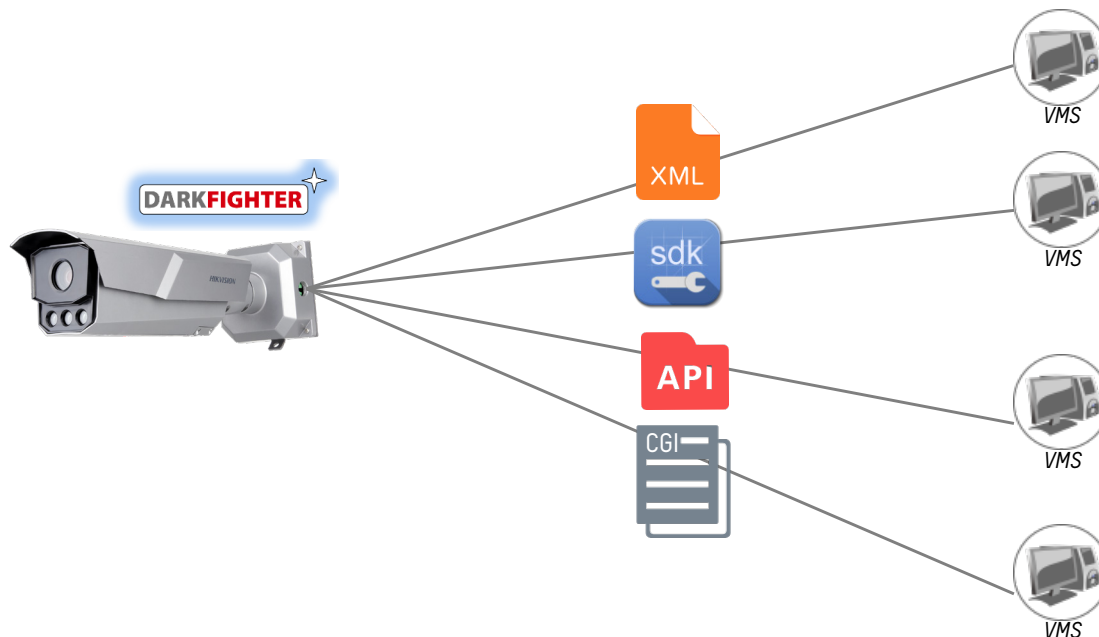

MANAGEMENT CENTRE

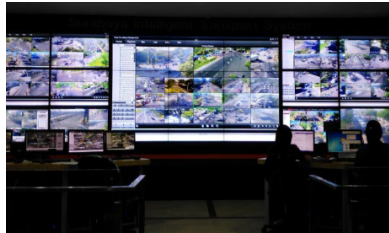

Compiling all the critical video from daily operations, the central office management centre is the core of a total CCTV system.

It provides the utmost reliability and manageability for data protection and alarm response. It also provides a means for improvement in business operations.

- **Video management platform:** The HikCentral Video Platform or iVMS-5200E platform is the core of the CCTV system to manage, view live, play back, and control all the daily operations on all connected devices.
- **Monitor display system:** Everything from standalone monitors to expansive TV walls.

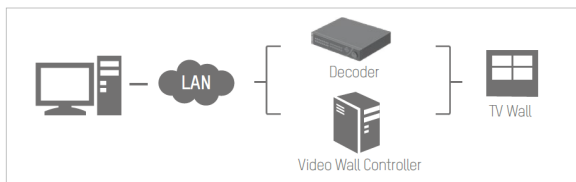

Hikvision display system

- LCD/LED/DLP video wall displays of different sizes are available to meet any requirement
- Powerful Decoder/Controller products support flexible screen jointing and window roaming
- One system supports integration of up to 72 screens into one video wall
- Supports multiple signal input types – Including DVI – to display signals from PCs on video walls

Mega Data Management Smart Search and Play Back

- Fully compatible with Hikvision Smart IPCs
- Quick, easy search for snapshots and recorded video based on plate numbers or keywords
- Playback the desired event footage at standard speed and fast-forward to skip past unrelated video

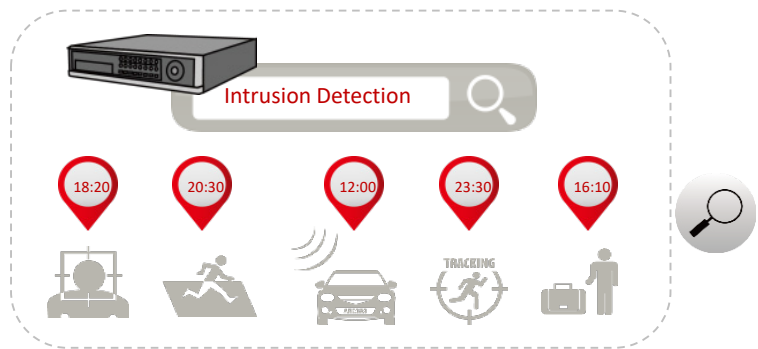

Multiple parking violation alarms to expedite response

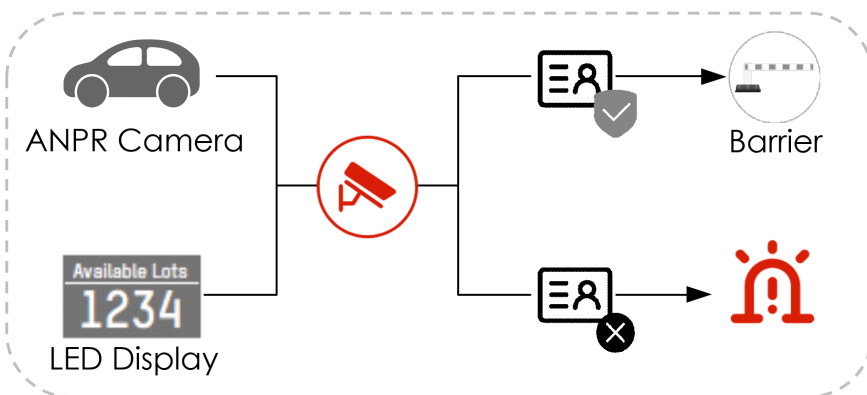

- An alarm will be triggered when a vehicle is recognised as included on blacklist; the barrier can remain closed to prohibit entry by that vehicle
- Whitelist Expiration Alarm: When a vehicle on a time-limited whitelist attempts to enter and/or park after expiration, an alarm will be triggered. This function is especially useful for hotel parking, visitor parking in residential areas, etc

Whitelist Expiration / Blacklist Alarm

PARKING ENTRANCE

- An alarm will be triggered when a vehicle remains in a parking area after business hours or other specified period
- Helps parking area management personnel quickly identify how many and which vehicles remain in a parking area after business hours or other specified period

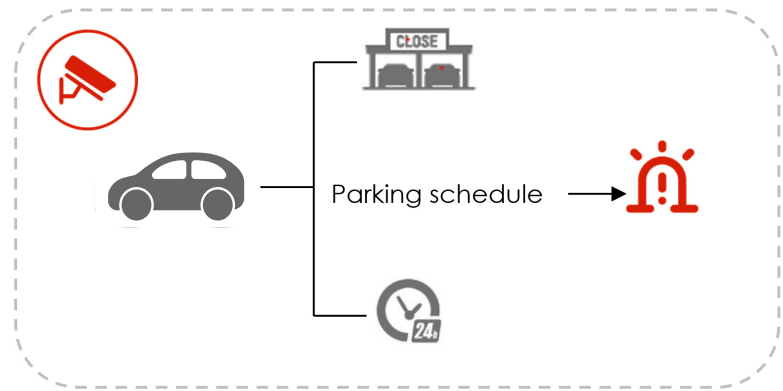

Parking after closing time / forbidden parking periods

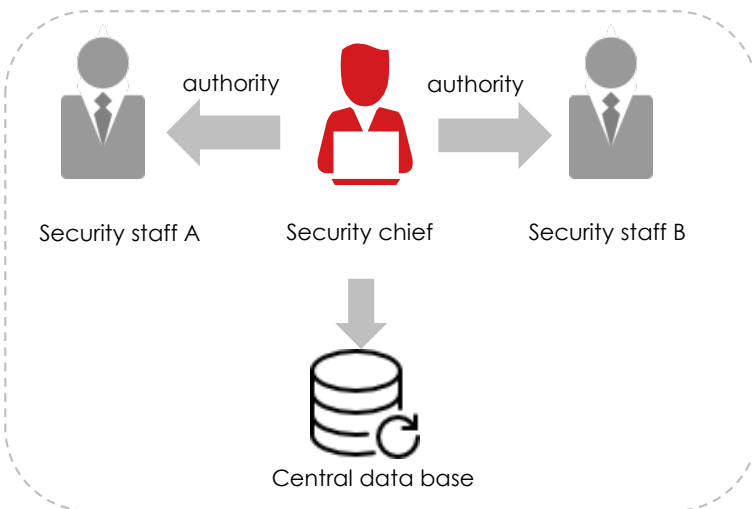

Centralised management security operator authority

- Centralised management of security personnel and authorities
- Security personnel have assigned authority levels, such as live view, playback, area cameras, or PTZ control
- Higher permission-level users have priority control over the system, i.e., they can takeover PTZ control, force logout of lower-level users, and more

High data safety Auto Network Replenishment (ANR)

- Auto backup on SD card when network is disconnected
- Video data will be transferred from SD card to NVR when network connection is restored
- Using Hikvision Micro SD cards for ANR storage is recommended for best performance

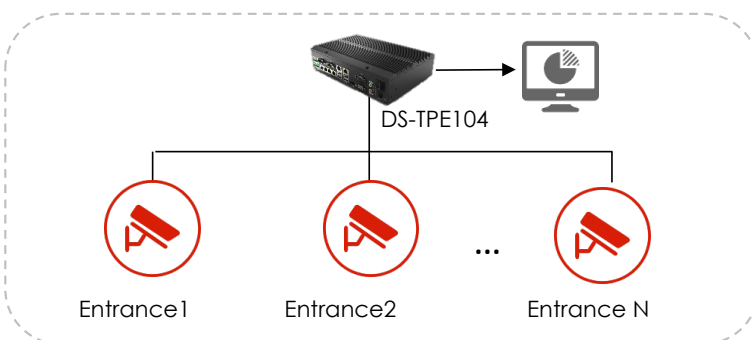
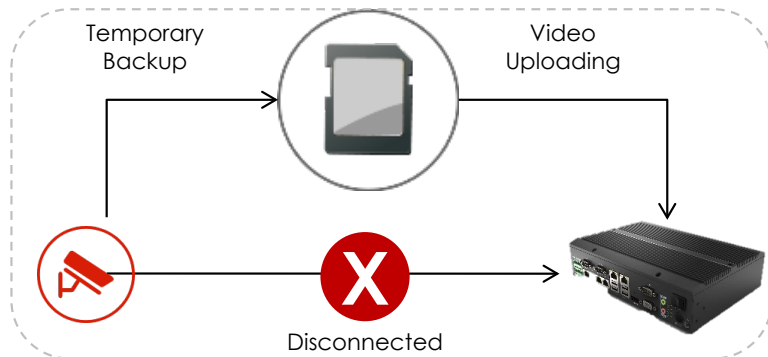

Business Intelligence Reports

- Generation of multiple parking area reports, including reports of multiple entries & exits, etc.
- Business reports inform management personnel of daily parking and visitor statistics, such as normal parking times, etc.

PRODUCT SHOWCASE



DS-TCM203/3813
ANPR Unit

- 2 MP, CMOS, 1920 x 1080, built-in LPR algorithm
- Integrated camera, housing, lens, power adaptor, supplement Lights
- Motorized lens
- Software one-key focus, easy debugging
- Built in whitelist, LPR identification support, barrier / gate control , audio output



DS-TVL224-4-5Y
ESE Outdoor LED Display

- Four lines of text, LED outdoor Display
- Integrates with speaker
- LED Brightness: 1,200 cd
- Colours: Red, yellow, green
- Pixel Resolution: 64 x 64
- Dot Pitch: P4.75
- Dimensions: 364 x 484 x 60mm



DS-TPE104(2T)
Control Terminal

- 4 Channels of lanes access
- 4 x 10/100 Mbps Ethernet ports, 2 x 1000 Mbps Ethernet ports, dual NICs
- 2 x RS485 ports, 3 x RS232 ports
- 4 x Relay ports support barrier / gate control
- 1 x Audio Output
- 2TB HDD included



DS-TME401/402-TL-S
Entrance / Exit Controller

- Entrance, HDD not included
- Supports chat, no card output, support LED audio remind,
- Supports to charge and allow car when system offline.



DS-7716/32NI-I4(-I4/16P)
ANPR NVR

- 160/256Mbps Bit Rate Input Max(up to 16/32-ch IP video)
- Third-party network cameras supported
- Up to 12MP resolution recording
- Support H.265/H.264+/H.264 video formats
- HDMI output at up to 4K (3840 x 2160) resolution
- 4 SATA, 2 USB 2.0, 1 USB 3.0
- *-I4/16P series support 16 independent PoE network interfaces



DS-9632/64NI-I8
ANPR NVR

- Support ANPR Cameras
- Maximum 320Mbps bitrate Input
- 200Mbps bitrate input (RAID enabled)
- Support 3rd party network cameras
- Up to 12MP resolution recording
- Support H.264/H.264+/H.265 video format
- 2x HDMI & 2x VGA output (3840x2160)
- Support RAID0, 1, 5, 10
- Support redundant power supply
- Dual digital network interfaces
- 8x SATA, 1x eSATA, 2x USB2.0, 1x USB3.0
- 19-inch rack-mounted 2U chassis



DS-96128/256NI-F16/F24 (/H)
ANPR NVR

- Maximum 400/640Mbps bitrate Input
- Support 3rd party network cameras
- Up to 8MP resolution recording
- HDMI & VGA output (1920x1080p)
- Support RAID0, 1, 5, 10
- Support redundant power supply
- F16: 16x SATA; F24: 24x SATA
- 1x eSATA, 1x mini SAS, 3x USB 2.0
- /H: support up to 12-ch HDMI output & LCD touch screen

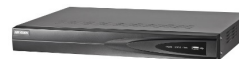

DS-7604NI-K1(/4P)
DS-7608/16NI-K2(/16P)
DS-7716/32NI-K4(/16P)
ANPR NVR

- Maximum 40/160Mbps bitrate Input
- Support 3rd party network cameras
- Up to 8MP resolution recording
- HDMI & VGA output (1920x1080p)
- Support RAID0, 1, 5, 10
- Support redundant power supply
- K1: 1 SATA; K2: 2 SATA ; K4: 4 SATA
- /P: built-in PoE switch ports

PARKING ENTRANCE

SUCCESS STORIES

The Parking Lot Guidance Solution, Zabrze, Poland



HIKVISION's Access control system provide the efficiency of access such as video recognition making non-stopping for entrance & exit , replace manual entrance control with ANPR technique, automatic control enhances the efficiency.

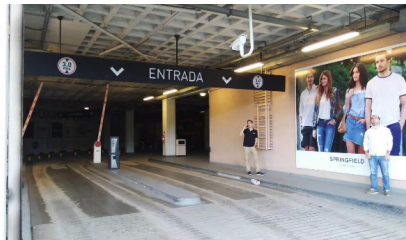

03-07-2018 Wed 17:22:16

Camera 01

Main Stream | Sub-Stream | Third Stream | Manual Capture | Record

Second-L | Armed

ID	Capture Time	Plate Color	Plate Number	Picture Position
180	20180307172211195			C:\Users\Administrator\ITCP Web\ScenePics\normalType\20180307\
179	20180307172211195			C:\Users\Administrator\ITCP Web\ScenePics\normalType\20180307\20180307172211195.jpg
178	20180307172000394			C:\Users\Administrator\ITCP Web\ScenePics\normalType\20180307\
177	20180307172000394			C:\Users\Administrator\ITCP Web\ScenePics\normalType\20180307\20180307172000394.jpg
176	20180307171922354			C:\Users\Administrator\ITCP Web\ScenePics\normalType\20180307\

EX-657NH | EX657NH | Measure Plate | Open Folder

Supplement Light | Image | Entrance/Exit

F1

Control Constant Light According to Brightness Condition

Control Constant Light According to Time Schedule

Start Time: 17:00

End Time: 08:00

Save

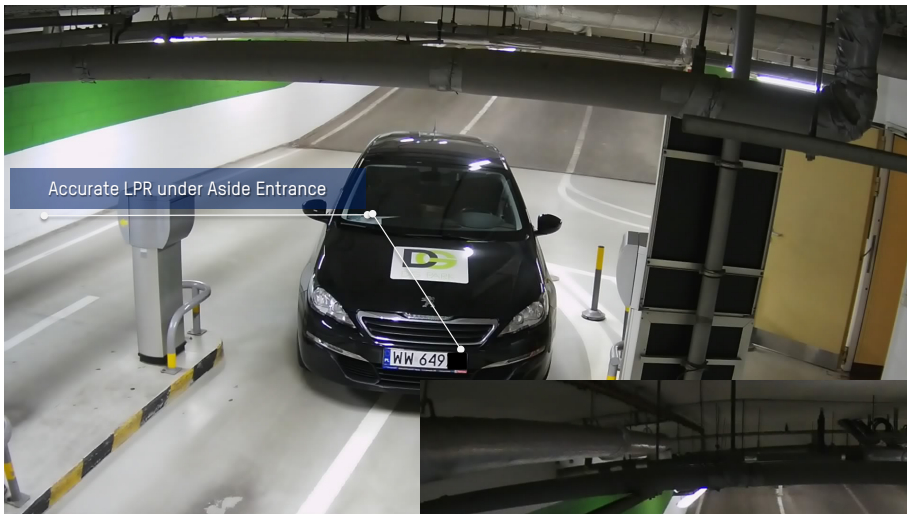

Lane: Capture Time:2018-04-15 21:42

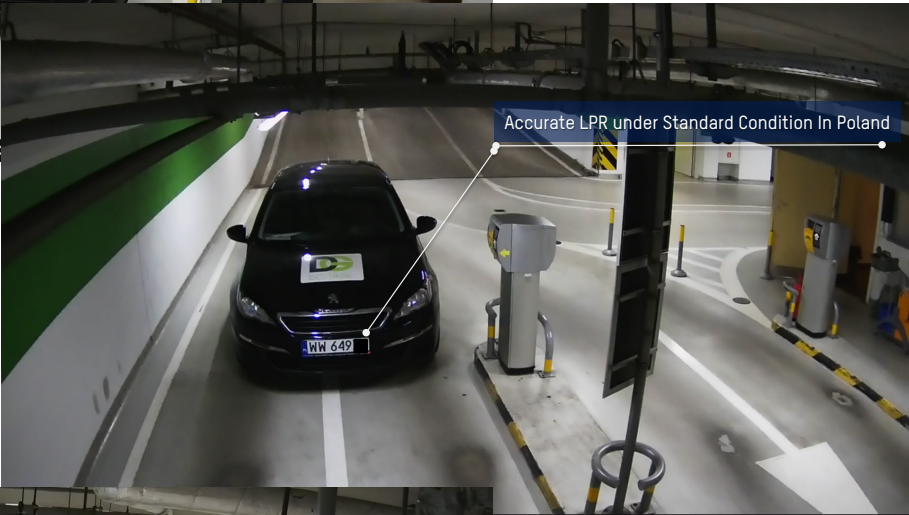

Accurate LPR under Standard Condition In Poland

9.904 Plate No:WW649

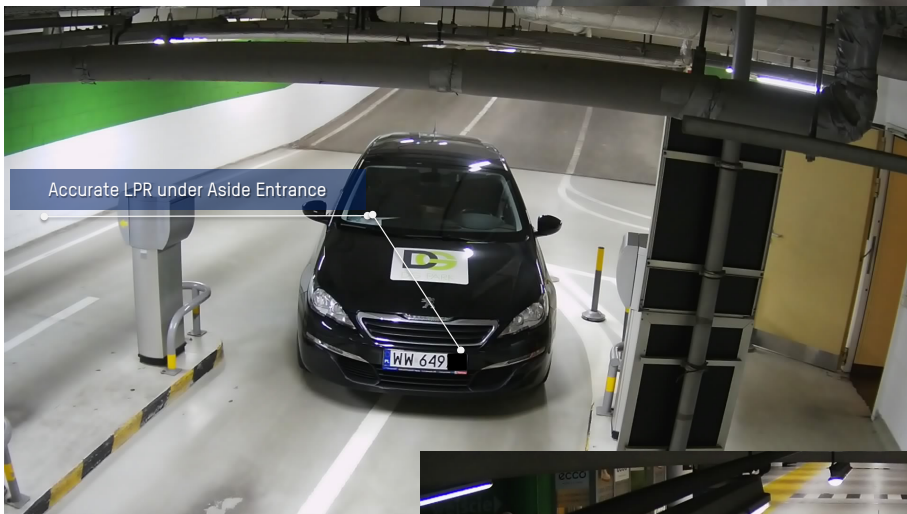

Lane: Capture Time:2018-04-15 21:42

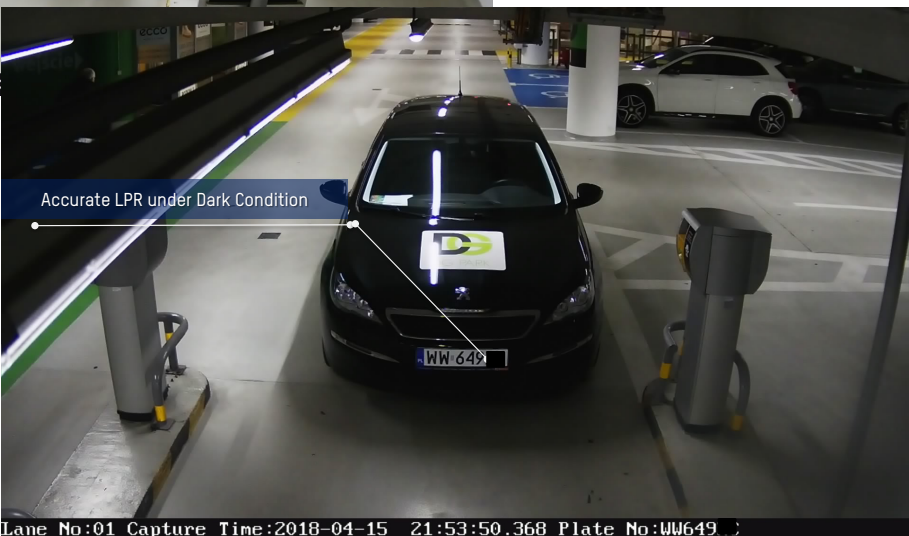

Accurate LPR under Dark Condition

Lane No:01 Capture Time:2018-04-15 21:53:50.368 Plate No:WW649

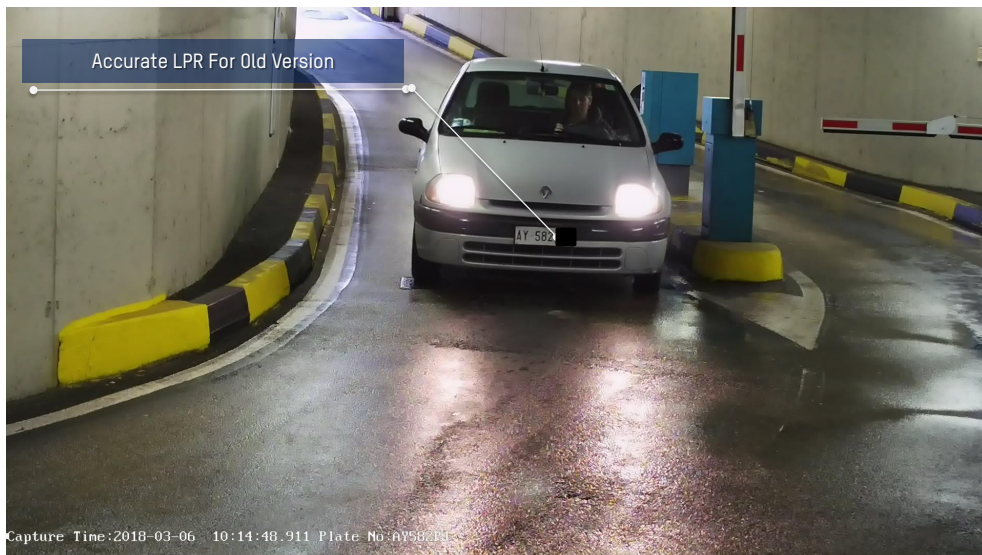



TAKE TOTAL CONTROL OF
VEHICLE ACCESS
SMART PARKING ACCESS SOLUTION



Hikvision Headquarters

No.555 Qianmo Road
310052 Hangzhou
China
T +86 571 88075998
sales@hikvision.com

Hikvision Europe

Dirk Storklaan 3
2132 PX Hoofddorp
The Netherlands
T +31 23 5542770
info.eu@hikvision.com

Hikvision France

6 rue Paul Cézanne,
93360 Neuilly-Plaisance
France
T +33 (0)1 85330450
info.fr@hikvision.com

Hikvision Italy

Via Abruzzo 12
Z.I. San Giacomo
31029 Vittorio Veneto
TV Italy
T +39 0438 6902
info.it@hikvision.com

Hikvision Poland

The Park, Office Building A
Krakowiaków 50
02-255 Warsaw, Poland
T +48 22 4600150
info.pl@hikvision.com

Hikvision Spain

Calle de Almazara 9
28760 Tres Cantos
Madrid, Spain
T +34 91 7371655
info.es@hikvision.com

Hikvision Czech

BETA Building, Vyskocilova
1481/4, Prague 4
Czech Republic
T +42 29 6182640
info.cz@hikvision.com

Hikvision Germany

Flughafenstr. 21
63263 Neu-Isenburg
Zeppelinheim, Germany
T +49 69 401507290
sales.dach@hikvision.com