

## DS-2XM6726G1-I(D)(M)(/ND) Mobile Dome Camera



- High quality imaging with 2MP resolution
- 2/2.8/4/6/8 mm fixed lens
- Clear imaging against strong back light due to 120 dB WDR technology
- Water and dust resistant (IP67) and vandal resistant (IK10)

## ▪ Specification

Camera	
Sensor	1/2.8" CMOS Progressive Scan
Resolution	2MP
Min. Illumination	0.01 Lux @ (F1.6, AGC ON)
Shutter Speed	1/3 s to 1/100,000 s
Wide Dynamic Range	120 dB
Day & Night	IR Cut Filter
Angle Adjustment	Pan: -30°~+30°, tilt: 0°~75°, rotate: 0°~360°
P/N	PAL: 25fps NTSC: 30fps
Protection Level	IP67, IK10
White Balance	Support four white balance configurations: fluorescent lamp, incandescent lamp, warm lamp and natural light; Support manual/automatic white balance adjustment.
Lens	
Lens Type	2mm/2.8mm/4mm/6mm/8mm
Focal Length & FOV	2 mm, horizontal FOV 132°, vertical FOV 77°, diagonal FOV 152° 2.8 mm, horizontal FOV 105°, vertical FOV 56°, diagonal FOV 126° 4 mm, horizontal FOV 87°, vertical FOV 44°, diagonal FOV 104° 6 mm, horizontal FOV 53°, vertical FOV 28°, diagonal FOV 62° 8 mm, horizontal FOV 41°, vertical FOV 23°, diagonal FOV 46°
Lens Mount	M12
Aperture	2mm: F2.25 2.8 /4/6 /8mm: F1.6
Focus	Manual focus
Illuminator	
IR Range	Up to 20m
IR Wavelength	850nm
Supplement Light Type	Infrared fill light lamp
Smart Supplement Light	Support
Video	
Max. Resolution	1920×1080
Main Stream	50Hz: 25fps (1920x1080, 1280 x 960, 1280x720) 60Hz: 30fps (1920x1080, 1280 x 960, 1280x720)
Sub-Stream	50Hz: 25fps (704x576, 640x480, 352x288, 320x240) 60Hz: 30fps (704x576, 640x480, 352x288, 320x240)
Third Stream	50Hz: 25fps (1920x1080, 1280 x 960, 1280x720) 60Hz: 30fps (1920x1080, 1280 x 960, 1280x720)
Video Compression	Main stream: H.264, H.265, H.264+, H.265+ Sub-stream: H.264, H.265, MJPEG, H.264+, H.265+ Third stream: H.264, H.265, H.264+, H.265+
Video Bit Rate	256 Kbps to 12Mbps
H.264 Type	Baseline Profile/Main Profile/High Profile
H.265 Type	Main Profile
Bit Rate Control	Constant Bit Rate, Variable Bit Rate
Stream Type	Main stream, sub stream, third stream

Scalable Video Coding (SVC)	H.264 and H.265 encoding
Region of Interest (ROI)	Support 2 fixed region for (main/sub) stream
<b>Audio</b>	
Audio Compression	G711U, G711A, G726, AAC, G722, PCM, AAC
Audio Bit Rate	64Kbps
Audio Sampling Rate	16 kHz
Environment Noise Filtering	Yes
<b>Network</b>	
Protocols	TCP/IP, ICMP, HTTP, HTTPS, FTP, DHCP, DNS, DDNS, Email ,RTP, RTSP, RTCP, NTP, UPnP, SMTP, SNMP, ICMP 802.1X, QoS, IPv6, Bonjour, ISUP5.0
Simultaneous Live View	Up to 8 channels
API	ONVIF (PROFILE S, PROFILE G, PROFILE T), ISAPI, SDK
User/Host	Up to 16 users, 3 levels: Administrator, Operator and User
Web Browser	IE8+, Chrome45+, Edge41+, Firefox45+
<b>Image</b>	
Image Settings	Support rotation mode. Browser and client software can adjust brightness, contrast, saturation and sharpness.
Day/Night Switch	Day/Night/Auto/Schedule
Image Enhancement	BLC, HLC, 3D DNR
SNR	> 50 dB
Privacy Mask	Enables configuration, and supports drawing of up to 4 areas
Picture Overlay	Support image overlay, uploading images, enabling, coordinates, etc.
Target Cropping	Support (only the third stream)
Backlight Compensation(BLC)	Support up, down, left, right, center and custom backlight compensation adjustment
<b>Interface</b>	
Ethernet Interface	-ID: 1 RJ45 10M/100M self-adaptive Ethernet port -IM/ND, IDM: 1 four-core M12 aviation plug
On-Board Storage	Built-in micro SD/SDHC/SDXC slot, up to 256 GB
Audio	1 built-in mic, mono sound
Video Output	Not supported
Reset Key	Yes
Interface Style	Interpolate
<b>Event</b>	
Basic Event	Motion detection, video tampering alarm
Smart Event	Line crossing detection Intrusion detection Region entrance detection Region exiting detection Unattended baggage detection Object removal detection Object detection: detects faces and upload images Scene change detection Defocus detection
Linkage	Upload to FTP, notify monitoring center, send email, trigger recording
<b>General</b>	
Camera Material	Metal

Camera Dimension	Camera: $\Phi$ 110 mm $\times$ 57.4 mm (4.3" $\times$ 2.26")
Package Dimension	Package : 252 $\times$ 160 $\times$ 95mm (9.9" $\times$ 6.3" $\times$ 3.7")
Camera Weight	Camera: Approx. 452 g (1 lb.)
Startup and Operating Conditions	-30 °C to 75°C (-22 °F to 167°F), humidity less than 95% or less (non-condensing)
General Function	Anti-flicker, heartbeat, mirror
Power	PoE: 0.30 A to 0.20 A, max: 7.5 W DC: 0.83 A to 0.21 A, max: 7.5 W
Power Supply	-ID: 9-36 V& PoE (802.3af, 36 V to 57 V) -IDM: 9-36 V& PoE (802.3af, 36 V to 57 V) -IM/ND: PoE (802.3af, 36 V to 57 V)
Power Interface	-ID: $\Phi$ 5.5 mm coaxial power plug, DC power supply, or PoE power supply -IM/ND: four-core M12 aviation plug, PoE power supply
Language	English, French, German, Russian, Italian, Korean, Portuguese, Spanish, Turkish, Polish, Czech
Software Reset	Support
Cable Length	50 cm
<b>Selection Parameter</b>	
PoE Support	PoE (802.3af)
<b>Approval</b>	
Class	Class B
EMC	FCC (47 CFR Part 15, Subpart B); CE-EMC (EN 55032: 2015, EN 61000-3-2: 2014, EN 61000-3-3: 2013, EN 50130-4: 2011 +A1: 2014);
Safety	UL (UL 60950-1); CB (IEC 60950-1:2005 + Am 1:2009 + Am 2:2013); CE-LVD (EN 60950-1:2005 + Am 1:2009 + Am 2:2013);
Environment	CE-RoHS (2011/65/EU);
Protection	IK10(IEC 62262:2002)
Automotive and Railway	EN50155-2017(EN 50155:2017, EN 50121-3-2:2016, IEC 60068-2-1:2007, IEC 60068-2-2:2007, IEC 60068-2-30:2005, IEC 61373:2010); EN45545 (EN 45545-2:2013+A1:2015); E-MARK (ECE R10)

## ▪ Available Model

DS-2XM6726G1-IDM(2mm/2.8mm/4mm/6mm)(AE)

DS-2XM6726G1-IM/ND(2mm/2.8mm/4mm/6mm)(AE)

DS-2XM6726G1-ID(2mm/2.8mm/4mm/6mm)(AE)

▪ Dimension

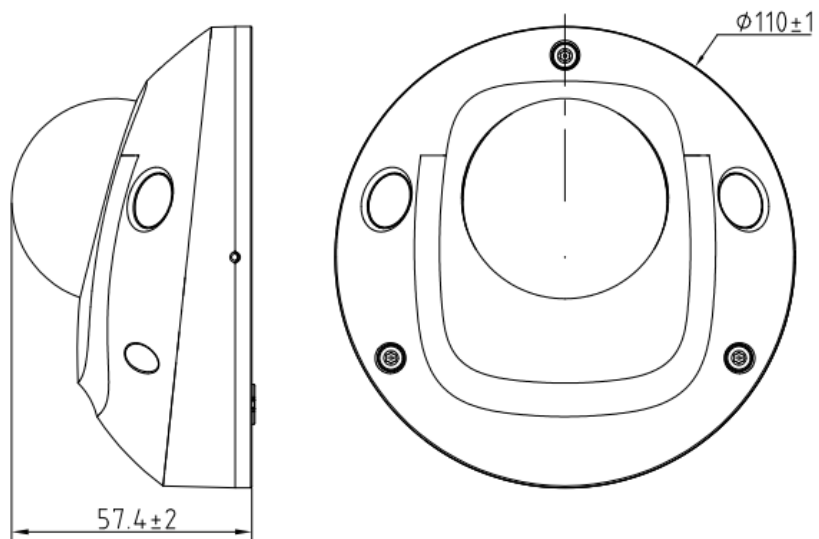

Unit: mm

▪

## Interface Definition

Model	Interface Type	Interface Form	Interface Definition	Interface Illustration
XM67	ID	RJ45/F	1.IPC_TX+ 2.IPC_TX- 3.IPC_RX+ 4.IDLE4 5.IDLE5 6.IPC_RX- 7.IDLE7 8.IDLE8	
		DC/F	Core: IPC_POWER Shell: IPC_GND	
	IDM	M12D4F	1.IPC_TX+ 2.IPC_RX+ 3.IPC_TX- 4.IPC_RX-	
		MOLEX-2M	1.IPC_POWER 2.IPC_GND	
	IM/ND	M12D4F	1.IPC_TX+ 2.IPC_RX+ 3.IPC_TX- 4.IPC_RX-	

### Headquarters

No.555 Qianmo Road, Binjiang District,  
 Hangzhou 310051, China  
 T +86-571-8807-5998  
 www.hikvision.com



Follow us on social media to get the latest product and solution information.

