

DS-2TD1217-3/QA Thermographic Network Turret Camera



Hikvision DS-2TD1217-3/QA Thermal & Optical Bi-spectrum Network Turret Camera supports video analysis for perimeter protection, and also temperature exception alarm for early fire prevention. With the deep learning algorithm, it can realize high precision VCA detection and real-time alarm. These camera series can be widely applied to villas, communities, parking lots, warehouses, construction sites, waste incineration plants, manufacturing workshops, etc.

- 160 × 120 resolution, 17 μm, VOx UFPA, NETD < 40 mK (25 °C, F# = 1.1)
- High accuracy temperature exception alarm, -20 °C to 150 °C (-4 °F to 302 °F) ± 8 °C (±14.4 °F)
- Image processing technology: linear, histogram, self-adaptive thermal AGC mode, DDE, 3D DNR
- Support smoking detection algorithm
- Support sun-reflection filter
- High quality detector with 10 years guarantee

▪ Specification

Thermal Module	
Image Sensor	Vanadium Oxide Uncooled Focal Plane Arrays
Resolution	160 × 120
Pixel Pitch	17 μm
Spectral Range	8 μm to 14 μm
NETD	<40 mK (@ 25 °C, F# = 1.1)
Focal Length	3.1 mm
IFOV	5.48 mrad
Field of View	50.0° × 37.2° (H × V)
Min. Focusing Distance	0.2 m
Aperture	F1.1
Digital Zoom	× 2, × 4
Optical Module	
Image Sensor	1/2.7" Progressive Scan CMOS
Resolution	2688 × 1520
Min. Illumination	0.0089Lux @(F1.6,AGC ON) ,0 Lux with IR
Shutter Speed	1 s to 1/100,000 s
Focal Length	4 mm
Field of View	84.0° × 44.8° (H × V)
Aperture (Range)	F1.6
WDR	120 dB
Image Effect	
Target Coloration	Yes. Supported in white hot and black hot mode.
Illuminator	
IR Distance	Up to 15 m
IR Intensity and Angle	Automatically adjusted
Audible and Visual Alarm	
White Light Range	Up to 30 m
Visual Alarm	Yes. White light alarm with adjustable flashing frequencies
Audio alarm	Yes, for two types of audible alarm (VCA, Temperature) 2 preset voice alerts (one for each) 6 importable user-defined voice alerts (4 options shared in the two types)
Smart Function	
VCA	4 VCA rule types (line crossing, intrusion, region entrance, and region exiting), up to 8 VCA rules in total.
Temperature Measurement	3 temperature measurement rule types, 21 rules in total (10 points, 10 areas, and 1 line)
Temperature Range	- 20 °C to 150 °C (- 4 °F to 302 °F)
Temperature Accuracy	± 8 °C (± 14.4 °F)
General Function	Fire detection, smoking detection, sun-reflection filter,

Video and Audio	
Main Stream	Thermal: 25 fps (1280 × 720, 704 × 576, 640 × 480, 352 × 288, 320 × 240) Optical: 50 Hz: 25 fps (2688 × 1520, 1920 × 1080, 1280 × 720) 60Hz: 30 fps (2688 × 1520, 1920 × 1080, 1280 × 720)
Sub-stream	Thermal: 25 fps (704 × 576, 352 × 288, 320 × 240) Optical: 50 Hz: 25 fps (704 × 576, 352 × 288) 60 Hz: 30 fps (704 × 480, 352 × 240)
Video Compression	Main Stream: H.265/H.264 Sub-Stream: H.265/H.264/MJPEG
Audio Compression	G.722.1/G.711ulaw/G.711alaw/MP2L2/G.726/PCM
Network	
Protocols	IPv4/IPv6, HTTP, HTTPS, 802.1x, QoS, FTP, SMTP, UPnP, SNMP, DNS, DDNS, NTP, RTSP, RTCP, RTP, TCP, UDP, IGMP, ICMP, DHCP, PPPoE,TLS
Network Storage	MicroSD/SDHC/SDXC card (up to 256 G) local storage, NAS (NFS, SMB/CIFS), Auto Network Replenishment (ANR)
API	ISAPI, HIKVISION SDK,ISUP, and third-party management platform, Open Network Video Interface,ONVIF (Profile S, Profile G, Profile T)
Simultaneous Live View	Up to 20 channels
User/Host level	Up to 32 users, 3 levels: Administrator, Operator, User
Security	User authentication (ID and PW), MAC address binding, HTTPS encryption, IEEE 802.1x(EAP-MD5, EAP-TLS), access control, IP address filtering
Client	iVMS-4200, Hik-Connect
Web Browser	Live view (plug-in allowed) : Internet Explorer 11 Live view (plug-in free) : Chrome 57.0 +, Firefox 52.0 + Local service : Chrome 57.0 +, Firefox 52.0 +
Interface	
Alarm Input	1, alarm input (0-5 VDC)
Alarm Output	1, alarm output (alarm response actions configurable)
Alarm Action	SD recording/Relay output/Smart capture/FTP upload/Email linkage
Audio Input	1, 3.5 mm Mic in/Line in interface Line input: 2 - 2.4 V [p-p], output impedance: 1 KΩ ± 10%
Audio Output	Linear level, impedance: 600 Ω
Communication Interface	1, RJ45 10 M/100 M Self-adaptive Ethernet interface. 1, RS-485 interface (half duplex)
General	
Web Client Language	32 languages English, Russian, Estonian, Bulgarian, Hungarian, Greek, German, Italian, Czech, Slovak, French, Polish, Dutch, Portuguese, Spanish, Romanian, Danish, Swedish, Norwegian, Finnish, Croatian, Slovenian, Serbian, Turkish, Korean, Traditional Chinese, Thai, Vietnamese, Japanese, Latvian, Lithuanian, Portuguese (Brazil)
Power Supply	12 VDC ± 25%, φ 5.5 mm coaxial power plug PoE (802.3af, class 3)

Power Consumption	12 VDC \pm 25%: 0.5 A, Max 6 W PoE (802.3af, class 3): 42.5 V to 57 V, 0.14 A to 0.22 A, Max 6.5 W
Working Temperature/Humidity	Temperature: - 40 °C to 65 °C (- 40 °F to 149 °F) Humidity: 95% or less
Protection Level	IP67 Standard TVS 6000V lightning protection, surge protection, voltage transient protection
Dimensions	138.3 mm \times 138.3 mm \times 123.1 mm (5.45" \times 5.45" \times 4.85 ")
Weight	940 g (2.07 lb)

▪ Range Table

Detection Range (Vehicles: 1.4 \times 4.0 m)	Detection Range (Humans: 1.8 \times 0.5 m)	Recognition Range (Vehicles: 1.4 \times 4.0 m)	Recognition Range (Humans: 1.8 \times 0.5 m)	Identification Range (Vehicles: 1.4 \times 4.0 m)	Identification Range (Humans: 1.8 \times 0.5 m)	Smoking Detection
280 m	91m	70 m	23 m	35 m	11 m	3.1m

▪ DORI

VCA Range (Vehicles: 1.4 \times 4.0 m)	VCA Range (Humans: 1.8 \times 0.5 m)	Temperature Measurement (Object: 0.2 \times 0.2 m)	Temperature Measurement (Object: 1 \times 1 m)	Fire Detection (Object: 0.2 \times 0.2m)
43 m	15 m	6.82m	34.1 m	31m

▪ Available Model





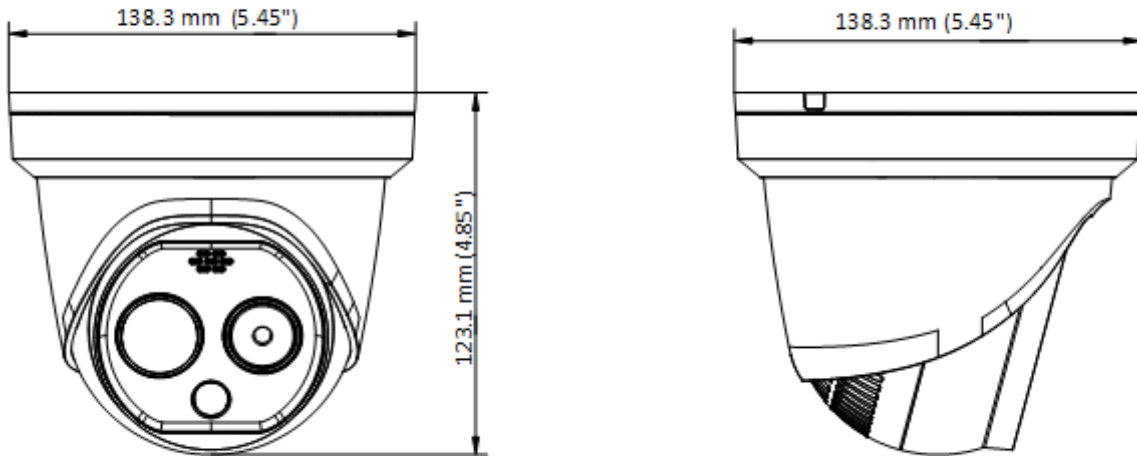

DS-2TD1217-3/QA

▪ **Dimension**



▪ **Accessory**

▪ **Optional**

DS-1273ZJ-140 Wall mount	DS-1273ZJ-140B Wall mount	DS-1271ZJ-140 Pendant Mount	DS-1275ZJ-SUS Vertical pole mount	DS-1276ZJ-SUS Corner mount
				
DS-1280ZJ-DM21 Junction box	DS-1273ZJ-140(BLACK) Wall mount			
				

COMPLIANCE NOTICE: The thermal series products might be subject to export controls in various countries or regions, including without limitation, the United States, European Union, United Kingdom and/or other member countries of the Wassenaar Arrangement. Please consult your professional legal or compliance expert or local government authorities for any necessary export license requirements if you intend to transfer, export, re-export the thermal series products between different countries.

Headquarters

No.555 Qianmo Road, Binjiang District,
Hangzhou 310051, China
T +86-571-8807-5998
www.hikvision.com



Follow us on social media to get the latest product and solution information.

