

HIKVISION

Body Camera Quick Start Guide



Scan the QR code for User
Manual.



Scan the QR code for
Portable Device Assistant
application.



See Far, Go Further

Quick Start Guide

© 2019 Hangzhou Hikvision Digital Technology Co., Ltd.
All rights reserved.

This Manual is the property of Hangzhou Hikvision Digital Technology Co., Ltd. or its affiliates (hereinafter referred to as “Hikvision”), and it cannot be reproduced, changed, translated, or distributed, partially or wholly, by any means, without the prior written permission of Hikvision. Unless otherwise expressly stated herein, Hikvision does not make any warranties, guarantees or representations, express or implied, regarding to the Manual, any information contained herein.

About this Manual

The Manual includes instructions for using and managing the Product. Pictures, charts, images and all other information hereinafter are for description and explanation only. The information contained in the Manual is subject to change, without notice, due to firmware updates or other reasons. Please find the latest version of this Manual at the Hikvision website (<http://www.hikvision.com/en/>).

Please use this Manual with the guidance and assistance of professionals trained in supporting the Product.

Trademarks Acknowledgement

- **HIKVISION** and other Hikvision’s trademarks and logos are the properties of Hikvision in various jurisdictions.
- Other trademarks and logos mentioned are the properties of their respective owners.

LEGAL DISCLAIMER

TO THE MAXIMUM EXTENT PERMITTED BY APPLICABLE LAW, THIS MANUAL AND THE PRODUCT DESCRIBED, WITH ITS HARDWARE, SOFTWARE AND FIRMWARE, ARE PROVIDED “AS IS” AND “WITH ALL FAULTS AND ERRORS”. HIKVISION MAKES NO WARRANTIES, EXPRESS OR IMPLIED, INCLUDING WITHOUT LIMITATION, MERCHANTABILITY, SATISFACTORY QUALITY, OR FITNESS FOR A PARTICULAR PURPOSE. THE USE OF THE PRODUCT BY YOU IS AT YOUR OWN RISK. IN NO EVENT WILL HIKVISION BE LIABLE TO YOU FOR ANY SPECIAL, CONSEQUENTIAL, INCIDENTAL, OR INDIRECT DAMAGES, INCLUDING, AMONG OTHERS, DAMAGES FOR LOSS OF BUSINESS PROFITS, BUSINESS INTERRUPTION, OR LOSS OF DATA, CORRUPTION OF SYSTEMS, OR LOSS OF DOCUMENTATION, WHETHER BASED ON BREACH OF CONTRACT, TORT (INCLUDING NEGLIGENCE), PRODUCT LIABILITY, OR OTHERWISE, IN CONNECTION WITH THE USE OF THE PRODUCT, EVEN IF HIKVISION HAS BEEN ADVISED OF THE POSSIBILITY OF SUCH DAMAGES OR LOSS.

YOU ACKNOWLEDGE THAT THE NATURE OF INTERNET PROVIDES FOR INHERENT SECURITY RISKS, AND HIKVISION SHALL NOT TAKE ANY RESPONSIBILITIES FOR ABNORMAL OPERATION, PRIVACY LEAKAGE OR OTHER DAMAGES RESULTING FROM CYBER-ATTACK, HACKER ATTACK, VIRUS INSPECTION, OR OTHER INTERNET SECURITY RISKS; HOWEVER, HIKVISION WILL PROVIDE TIMELY TECHNICAL SUPPORT IF REQUIRED.

YOU AGREE TO USE THIS PRODUCT IN COMPLIANCE WITH ALL APPLICABLE LAWS, AND YOU ARE SOLELY RESPONSIBLE FOR ENSURING THAT YOUR USE CONFORMS TO THE APPLICABLE LAW. ESPECIALLY, YOU ARE RESPONSIBLE, FOR USING THIS PRODUCT IN A MANNER THAT DOES NOT INFRINGE ON THE RIGHTS OF THIRD PARTIES, INCLUDING WITHOUT LIMITATION, RIGHTS OF PUBLICITY, INTELLECTUAL PROPERTY RIGHTS, OR DATA PROTECTION AND OTHER PRIVACY RIGHTS. YOU

SHALL NOT USE THIS PRODUCT FOR ANY PROHIBITED END-USES, INCLUDING THE DEVELOPMENT OR PRODUCTION OF WEAPONS OF MASS DESTRUCTION, THE DEVELOPMENT OR PRODUCTION OF CHEMICAL OR BIOLOGICAL WEAPONS, ANY ACTIVITIES IN THE CONTEXT RELATED TO ANY NUCLEAR EXPLOSIVE OR UNSAFE NUCLEAR FUEL-CYCLE, OR IN SUPPORT OF HUMAN RIGHTS ABUSES.

IN THE EVENT OF ANY CONFLICTS BETWEEN THIS MANUAL AND THE APPLICABLE LAW, THE LATER PREVAILS.

Regulatory Information

FCC Information

Please take attention that changes or modification not expressly approved by the party responsible for compliance could void the user's authority to operate the equipment.

FCC compliance: Please take attention that changes or modification not expressly approved by the party responsible for compliance could void the user's authority to operate the equipment.

Note: This product has been tested and found to comply with the limits for a Class B digital device, pursuant to Part 15 of the FCC Rules. These limits are designed to provide reasonable protection against harmful interference in a residential installation. This product generates, uses, and can radiate radio frequency energy and, if not installed and used in accordance with the instructions, may cause harmful interference to radio communications. However, there is no guarantee that interference will not occur in a particular installation. If this product does cause harmful interference to radio or television reception, which can be determined by turning the equipment off and on, the user is encouraged to try to correct the interference by one or more of the following measures:

- Reorient or relocate the receiving antenna.
- Increase the separation between the equipment and receiver.
- Connect the equipment into an outlet on a circuit different from that to which the receiver is connected.
- Consult the dealer or an experienced radio/TV technician for help.

This equipment should be installed and operated with a minimum distance 20cm between the radiator and your body.

FCC Conditions

This device complies with part 15 of the FCC Rules. Operation is subject to the following two conditions:

1. This device may not cause harmful interference.
2. This device must accept any interference received, including interference that may cause undesired operation.

EU Conformity Statement



This product and - if applicable - the supplied accessories too are marked with "CE" and comply therefore with the applicable harmonized European standards listed under the Radio Equipment Directive 2014/53./EU, the EMC Directive 2014/30/EU, the LVD Directive 2014/35/EU, the RoHS Directive 2011/65/EU.

2012/19/EU (WEEE directive): Products marked with this symbol cannot be disposed of as unsorted municipal waste in the European Union. For proper recycling, return this product to your local supplier upon the purchase of equivalent new



equipment, or dispose of it at designated collection points. For more information see: www.recyclethis.info. 2006/66/EC (battery directive): This product contains a



battery that cannot be disposed of as unsorted municipal waste in the European Union. See the product documentation for specific battery information. The battery is marked with this symbol, which may

include lettering to indicate cadmium (Cd), lead (Pb), or mercury (Hg). For proper recycling, return the battery to your supplier or to a designated collection point. For more information, see: www.recyclethis.info.

Industry Canada ICES-003 Compliance

This device meets the CAN ICES-3 (B)/NMB-3(B) standards requirements.

This device complies with Industry Canada licence-exempt RSS standard(s). Operation is subject to the following two conditions:

- 1) this device may not cause interference, and
- 2) this device must accept any interference, including interference that may cause undesired operation of the device.

Le présent appareil est conforme aux CNR d'Industrie Canada applicables aux appareils radioexempts de licence. L'exploitation est autorisée aux deux conditions suivantes :

- 1) l'appareil ne doit pas produire de brouillage, et
- 2) l'utilisateur de l'appareil doit accepter tout brouillage radioélectrique subi, même si le brouillage est susceptible d'en compromettre le fonctionnement.



Under Industry Canada regulations, this radio transmitter may only operate using an antenna of a type and maximum (or lesser) gain approved for the transmitter by Industry Canada. To reduce potential radio interference to other users, the antenna type and its gain should be so chosen that the equivalent isotropically radiated power (e.i.r.p.) is not more than that necessary for successful communication.

Conformément à la réglementation d'Industrie Canada, le présent émetteur radio peut

fonctionner avec une antenne d'un type et d'un gain maximal (ou inférieur) approuvé pour l'émetteur par Industrie Canada. Dans le but de réduire les risques de brouillage radioélectrique à l'intention des autres utilisateurs, il faut choisir le type d'antenne et son gain de sorte que la puissance isotrope rayonnée équivalente (p.i.r.e.) ne dépasse pas l'intensité nécessaire à l'établissement d'une communication satisfaisante.

Symbol Conventions

The symbols that may be found in this document are defined as follows.

Symbol	Description
	Provides additional information to emphasize or supplement important points of the main text.
	Indicates a potentially hazardous situation, which if not avoided, could result in equipment damage, data loss, performance degradation, or unexpected results.



Indicates a hazard with a high level of risk, which if not avoided, will result in death or serious injury.

Safety Instruction



- Proper configuration of all passwords and other security settings is the responsibility of the installer and/or end-user.
- In the use of the product, you must be in strict compliance with the electrical safety regulations of the nation and region. Please refer to technical specifications for detailed information.
- Input voltage should meet both the SELV (Safety Extra Low Voltage) and the Limited Power Source with 5 VDC according to the IEC60950-1 standard. Please refer to technical specifications for detailed information.
- DO NOT connect several devices to one power adapter as adapter overload may cause over-heating or a fire hazard.
- Please make sure that the plug is firmly connected to the power socket.
- If smoke, odor or noise rise from the device, turn off the power at once and unplug the power cable, and then please contact the service center.

Preventive and Cautionary Tips

Before connecting and operating your device, please be advised of the following tips:

- The device is only applicable to the area of which the altitude is under 2,000 m.
- The device is only applicable to the non-tropical area.
- Using battery of incorrect model may cause explosion. Handle the used battery according to the local requirements.
- Discard the scrapped battery according to the local laws and regulations. If there is no law or regulation about battery, discard it in the electronic equipment waste bin and keep it far away from children.
- DO NOT expose the battery (including battery pack or assembled battery) in overheated environment such as sunlight and fire.
- DO NOT place the device near exposed fire, such as a burned candle.
- Avoid the device from water.
- Make sure that all the related equipment is power-off during the installation.
- DO NOT place the product in high-temperature or damp environment, and DO NOT expose it to high electromagnetic radiation.
- If the product does not function properly, please contact your dealer or the nearest service center. DO NOT disassemble the product for repair or maintenance by yourself.
- Only use the battery, power adapter and assembly parts specified by the manufacturer.
- Consult the authorized dealer or technician from Hikvision for any question and request for product using.

1 Product Introduction

1.1 Introduction

Body camera (hereinafter referred to as device) highly integrates with record, local storage, GPS, etc. It is embedded with positioning module with high sensitivity and ultra-low consumption, locating the occurring position of events accurately. It can record the process and condition of events completely via recorded video and audio. You can also tag the important data for future search.

It is small and light, convenient to carry, and can be worn on the shoulder, satisfying the requirement of mobile duty and evidence record for single person. It is widely applicable to public security protection, city management, industry and commerce, etc.

1.2 Key Feature

- Full HD record.
- Supports GPS, and the position information can be uploaded to the command center in real time.
- Supports IR night vision. Even in low illumination condition, the facial characteristics in recorded video are clear.
- Waterproof, dustproof, and fall protection, adaptable to all-weather field operation.
- Wi-Fi accessible.

NOTE

The functions vary with different models. The actual product prevails.

1.3 Appearance

The device appearance is shown as Figure 1-1.

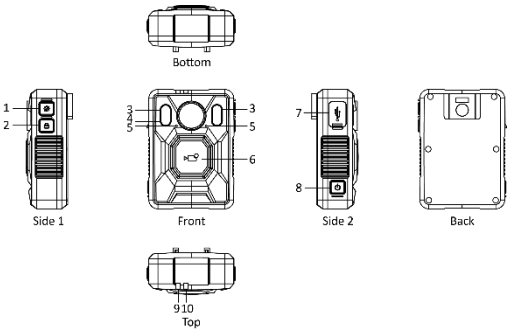



Figure 1-1 Appearance

The appearance description is shown as Table 1-1.

Table 1-1 Appearance Description

No.	Name	Description
1	Mute button	<ul style="list-style-type: none">● After the device starts up, hold it to enable mute mode. Then indicators, LED light, IR light, and vibration will be disabled.● In mute mode, hold it to disable mute mode.

No.	Name	Description
2	Tag button/LED light button	<ul style="list-style-type: none"> • During record, press it to make a tag for the important data. • After the device starts up, hold it to turn on LED light for light supplement or emergency illumination. Hold it again to turn off LED light.
3	IR lights	<ul style="list-style-type: none"> • If you set IR as Open, the IR lights will be enabled during record or live view of network transmission. • If you set IR as Auto, the IR lights will be enabled automatically during record or live view of network transmission when the illumination is insufficient. <p> NOTE You can set IR via Body Camera Assistant software. Refer to User Manual for details.</p>
4	LED light	<p>After the device starts up, hold LED light button to turn on LED light for light supplement or emergency illumination. Hold it again to turn off LED light.</p> <p> NOTE If you turn on LED light while IR function is enabled already, the IR function will be disabled forcedly. After you turn off LED light, the IR function will restore to be enabled.</p>
5	MIC	For voice collection.
6	Record	<ul style="list-style-type: none"> • After the device starts up, press it to enable record. • During record, hold it disable record.
7	Mini USB interface	For charging, data transmission, and debugging.
8	On/Off button	<ul style="list-style-type: none"> • Hold it for three seconds to turn on the device.

No.	Name	Description
		<ul style="list-style-type: none"> • After the device starts up, hold it for three seconds to turn off the device.
9	Indicator 1	<ul style="list-style-type: none"> • The device is being turned on: Indicator 1 changes to red and then becomes unlit. Indicator 2 becomes solid green. • The device is recording: Indicator 1 flashes in red slowly, and indicator 2 is solid green. • The device is in pre-record: Indicator 1 flashes in green slowly, and indicator 2 is solid green. • The device is in low power: Indicator 1 flashes in red fast, and indicator 2 stays the former status. • The device is out of memory: Indicator 1 stays the former status, and indicator 2 flashes in yellow fast. • The device is being charged after it is off: Indicator 1 is solid red, and indicator 2 is unlit. • The device is being charged after it is on: Indicator 1 is solid red, and indicator 2 is solid green. • The device is fully charged after it is off: Indicator 1 is solid green, and indicator 2 is unlit. • The device is fully charged after it is on: Indicator 1 is solid green, and indicator 2 is solid green.
	Indicator 2	

2 Installation

2.1 Install Shoulder Clip

Install the shoulder clip if you want to wear the device on your shoulder.

Steps:

1. Insert the shoulder clip down into the slot on the device back.

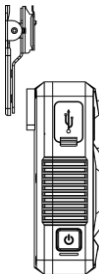

Figure 2-1 Install Shoulder Clip

2. Check if the clip is inserted into the slot firmly.

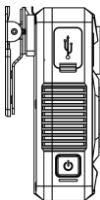

Figure 2-2 Successful Installation

2.2 Uninstall Shoulder Clip

You can uninstall the shoulder clip if you do not want to wear the device on your shoulder.

Steps:

1. Press the buckles on both sides of the clip inwards with your fingers.

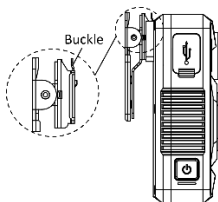



Figure 2-3 Press Buckles

2. Slide the clip upwards to uninstall it.

3 Basic Operation

3.1 Startup and Shutdown

- Startup: Hold  for 3 seconds until indicator 1 displays red. After a small period of time, the device vibrates for 0.5 second, indicator 1 becomes unlit, and indicator 2 changes to solid green, indicating the device has started up.

- **Shutdown:** Hold  for 3 seconds. Then the device vibrates for 0.5 second, and the two indicators becomes unlit, indicating the device is shut down.



Vibration is enabled by default. You can disable vibration via Body Camera Assistant software. Refer to User Manual for details.

3.2 Charge

When the device is in low power, Indicator 1 flashes in red fast, and indicator 2 stays the former status. Charge it in time.

Steps:

1. Open the Mini USB interface cover.
2. Insert one end of USB cable to the Mini USB interface, and the other end to the charger.





- Use the matched charger to charge the device.
- Quick charging is enabled by default. In quick charging mode, record and other functions will be disabled. You can disable the function via Body Camera Assistant software. Refer to User Manual for details.

3.3 Turn on/off LED Light

When the environment is dim or dark, or in emergency condition, you can hold  to turn on LED light for light supplement or emergency illumination. Hold the button again to turn off LED light.

3.4 Record

- After the device starts up, press , and the device vibrates for 0.5 second, indicating record is enabled.
- During record, hold , and the device vibrates for 0.5 second, indicating record is disabled.



If you have enabled post-record, during record, hold , and the device vibrates for 1 second. After the set post-record time is up, the device vibrates for 0.5 second, and the post-record ends. For post-record settings, refer to User Manual for details.

3.5 Tag Important Data

You can tag the important data of the video for future search.



During record, press  to make a tag, and the device vibrates for 0.5 second, indicating tagging starts. The tagged files are named with IMP to distinguish with untagged files.



- Tagging only takes effect with the current record. When the record ends, tagging stops.
- You cannot cancel tagging after it starts.

3.6 Enable/Disable Mute Mode

You can enable mute mode, in which the indicators, LED light, IR lights, and vibration will be disabled.

- After the device starts up, hold  to enable mute mode.
- In mute mode, hold  to disable the mode, and the device vibrates for 0.5 second, indicating the mute mode is disabled.

3.7 Alarm

When the memory is insufficient or the power is low, the device will alarm automatically.

- When the memory is insufficient, indicator 1 stays the former status, indicator 2 flashes in yellow fast, and the device vibrates for 0.5 second twice every 30 seconds.
- When the power is low, indicator 1 flashes in red fast, indicator 2 stays the former status, and the device vibrates for 0.5 second twice every 30 seconds.

 NOTE

- When the memory is insufficient, it is recommended to back up the data and clear the internal storage to avoid the normal usage. For backup, refer to User Manual for details.
- When the power is low, charge the device in time. Refer to 3.2 *Charge*.

4 Body Camera Assistant Operation

You can log in to the device via Body Camera Assistant to view logs and videos, and configure parameters remotely.

 NOTE

- Get Body Camera Assistant from the official website (<https://www.hikvision.com/en/>).
- Assistant mentioned below refers to Body Camera Assistant.

4.1 Install Assistant

Install Body Camera Assistant according to the operating system of your computer.

Steps:

1. Double-click the application to start installing.

 NOTE

- Install BodyCameraAssistant-win32.exe if your computer is in 32-bit operating system.
 - Install BodyCameraAssistant-win64.exe if your computer is in 64-bit operating system.
2. Follow the wizard to install the assistant.

4.2 Log in

Log in to the device via the assistant to operate.

Before you start

Connect the device to your computer with the USB cable, and turn on the device.

1. Double-click the icon of Body Camera Assistant to start it.
2. Click **Recognize device** to start recognizing. Then the recognized device will be listed.



Figure 4-1 Recognized Device

3. Click the recognized device, input device password, and then click **Login** to log in.

 NOTE

The device default password is 123456. Change the password in time. Refer to User Manual for details.

4.3 Log out

1. Click  on the upper left corner of the interface.



Figure 4-2 Log out

2. Click **Exit** to log out of the assistant.

5 FAQ

5.1 Why does the device fail to start up?

- The device is out of power. Shut down the device and connect it to the charger to charge for at least 20 minutes.

5.2 Why does the device fail to record?

- There is insufficient memory. Back up the data in the device and clear the storage.
- Formatting storage error. Format the device via Body Camera Assistant.

5.3 Why cannot the device be configured after it is connected to the computer?

- Exit from Body Camera Assistant installed on the computer.
- Unplug and then plug the USB cable.

5.4 Why cannot the devcie be logged in to via Body Camera Assistant?

- If you forget the password, reset the password.
- Password is incorrect. Log in with the right password.
- Reboot the device, and connect it to the computer again.