

DS-2CD2163G2-LI(S)(2U)

6 MP Acusense Smart Hybrid Light Fixed Dome Network Camera

AcuSense



- High quality imaging with 6 MP resolution
- Acusense: Focus on human and vehicle classification based on deep learning
- Smart Hybrid Light: Integrates IR and White lights, 4 supplemental lighting modes
- -2U: Built-in dual microphone for real-time high quality audio security
- Clear imaging against strong back light due to 120 dB true WDR technology
- Efficient H.265+ compression technology
- Water and dust resistant (IP67) and vandal-resistant (IK10)

▪ Specification

| Camera | |
|-----------------------------|--|
| Image Sensor | 1/2.4" Progressive Scan CMOS |
| Max. Resolution | 3200 × 1800 |
| Min. Illumination | Color: 0.005 Lux @ (F1.6, AGC ON),B/W: 0 Lux with IR |
| Shutter Time | 1/3 s to 1/100,000 s |
| Day & Night | IR cut filter |
| Angle Adjustment | Pan: 0° to 355°,tilt: 0° to 75°,rotate: 0° to 355° |
| Lens | |
| Lens Type | Fixed focal lens, 2.8 and 4 mm optional |
| Focal Length & FOV | 2.8 mm, horizontal FOV 105°, vertical FOV 55°, diagonal FOV 127° 4 mm, horizontal FOV 78°, vertical FOV 38°, diagonal FOV 96° |
| Lens Mount | M12 |
| Iris Type | Fixed |
| Aperture | F1.6 |
| Depth of Field | 2.8 mm: 1.8 m to ∞ 4 mm: 3.1 m to ∞ |
| DORI | |
| DORI | 2.8 mm, D: 76 m, O: 30 m, R: 15 m, I: 7 m 4 mm, D: 115 m, O: 45 m, R: 23 m, I: 11 m |
| Illuminator | |
| Supplement Light Type | IR,White Light |
| Supplement Light Range | Up to 30 m |
| Smart Supplement Light | Yes |
| IR Wavelength | 850 nm |
| Video | |
| Main Stream | 50 Hz: 25 fps (3200 × 1800, 2688 × 1520, 1920 × 1080, 1280 × 720) 60 Hz: 30 fps (3200 × 1800, 2688 × 1520, 1920 × 1080, 1280 × 720) |
| Sub-Stream | 50 Hz: 25 fps (1280 × 720, 640 × 480, 640 × 360) 60 Hz: 30 fps (1280 × 720, 640 × 480, 640 × 360) |
| Third Stream | 50 Hz: 10 fps (1920 × 1080, 1280 × 720, 640 × 480, 640 × 360) 60 Hz: 10 fps (1920 × 1080, 1280 × 720, 640 × 480, 640 × 360) *Third stream is supported under certain settings. |
| Video Compression | Main stream: H.265/H.264/H.264+/H.265+, Sub-stream: H.265/H.264/MJPEG, Third stream: H.265/H.264, *Third stream is supported under certain settings. |
| Video Bit Rate | 32 Kbps to 16 Mbps |
| H.264 Type | Baseline Profile,Main Profile,High Profile |
| H.265 Type | Main Profile |
| Scalable Video Coding (SVC) | H.264 and H.265 encoding |
| Bit Rate Control | CBR,VBR |
| Region of Interest (ROI) | 1 fixed region for main stream and sub-stream |
| Target Cropping | Yes |

| Audio | |
|-----------------------------|---|
| Audio Compression | -2U: G.711/G.722.1/G.726/MP2L2/PCM/MP3/AAC-LC |
| Audio Bit Rate | -2U: 64 Kbps (G.711ulaw/G.711alaw)/16 Kbps (G.722.1)/16 Kbps (G.726)/32 to 160 Kbps (MP2L2)/8 to 320 Kbps (MP3)/16 to 64 Kbps (AAC-LC) |
| Audio Sampling Rate | -2U: 8 kHz/16 kHz/32 kHz/48 kHz |
| Environment Noise Filtering | -2U: Yes |
| Network | |
| Protocols | TCP/IP, ICMP, HTTP, HTTPS, FTP, DHCP, DNS, DDNS, RTP, RTSP, RTCP, NTP, UPnP, SMTP, IGMP, 802.1X, QoS, IPv4, IPv6, UDP, Bonjour, SSL/TLS, PPPoE, SNMP, WebSocket, WebSockets |
| Simultaneous Live View | Up to 6 channels |
| API | Open Network Video Interface (Profile S, Profile G),ISAPI,SDK,ISUP |
| Security | Password protection, complicated password, HTTPS encryption, IP address filter, Security Audit Log, basic and digest authentication for HTTP/HTTPS, TLS 1.1/1.2/1.3, WSSE and digest authentication for Open Network Video Interface |
| User/Host | Up to 32 users 3 user levels: administrator, operator, and user |
| Client | iVMS-4200,Hik-Connect,Hik-Central |
| Network Storage | NAS (NFS, SMB/CIFS),Auto Network Replenishment (ANR), Together with high-end Hikvision memory card, memory card encryption and health detection are supported. |
| Web Browser | Plug-in required live view: IE 11, Plug-in free live view: Chrome 80+, Firefox 80+, Edge 89+, Safari 13+, Local service: Chrome 80+, Firefox 80+, Edge 89+, Safari 13+ |
| Image | |
| Image Parameters Switch | Yes |
| Day/Night Switch | Day,Night,Auto,Schedule |
| Wide Dynamic Range (WDR) | 120 dB |
| SNR | ≥ 52 dB |
| Image Enhancement | BLC,HLC,3D DNR |
| Privacy Mask | 8 programmable polygon privacy masks |
| Interface | |
| Ethernet Interface | 1 RJ45 10 M/100 M self-adaptive Ethernet port |
| On-Board Storage | Built-in memory card slot, support microSD/microSDHC/microSDXC card, up to 512 GB |
| Alarm | -S: 1 input, 1 output (max. 12 VDC, 30 mA) |
| Reset Key | Yes |
| Audio | Built-in Microphone: -2U: Dual Array Microphone -S: 1 input (line in), two-core terminal block, max. input amplitude: 3.3 Vpp, input impedance: 4.7 KΩ, interface type: non-equilibrium 1 output (line out), two-core terminal block, max. output amplitude: 3.3 Vpp, output impedance: 100 Ω, interface type: non-equilibrium |
| Event | |
| Basic Event | Motion detection (support alarm triggering by specified target types (human and vehicle)),video tampering alarm,exception |

| | |
|----------------------------------|---|
| Smart Event | Unattended baggage detection, object removal detection |
| Linkage | Upload to FTP/NAS/memory card,notify surveillance center,send email,trigger recording,trigger capture,-S: trigger alarm output |
| Deep Learning Function | |
| Perimeter Protection | Line crossing, intrusion, region entrance, region exiting Support alarm triggering by specified target types (human and vehicle) |
| General | |
| Power | 12 VDC \pm 25%, 0.65 A, max. 7.8 W, \varnothing 5.5 mm coaxial power plug,reverse polarity protection, PoE: IEEE 802.3af, Class 3, max. 9.5 W |
| Material | Base: aluminum alloy, cover: aluminum alloy |
| Dimension | \varnothing 121.5 mm \times 97.6 mm (\varnothing 4.78" \times 3.84") |
| Package Dimension | 150 mm \times 150 mm \times 141 mm (5.91" \times 5.91" \times 5.55") |
| Weight | Approx. 600 g (1.3 lb.) |
| With Package Weight | Approx. 840 g (1.9 lb.) |
| Storage Conditions | -30 °C to 60 °C (-22 °F to 140 °F). Humidity 95% or less (non-condensing) |
| Startup and Operating Conditions | -30 °C to 60 °C (-22 °F to 140 °F). Humidity 95% or less (non-condensing) |
| Language | 33 languages: English, Russian, Estonian, Bulgarian, Hungarian, Greek, German, Italian, Czech, Slovak, French, Polish, Dutch, Portuguese, Spanish, Romanian, Danish, Swedish, Norwegian, Finnish, Croatian, Slovenian, Serbian, Turkish, Korean, Traditional Chinese, Thai, Vietnamese, Japanese, Latvian, Lithuanian, Portuguese (Brazil), Ukrainian |
| General Function | Heartbeat,mirror,flash log,password reset via email,pixel counter,anti-banding |
| Approval | |
| EMC | CE-EMC: EN 55032:2015+A1:2020, EN 50130-4:2011+A1:2014, EN IEC 61000-3-2:2019+A1:2021, EN 61000-3-3:2013+A1:2019+A2:2021, RCM: AS/NZS CISPR 32: 2015, IC: ICES-003: Issue 7, KC: KN32: 2015, KN35: 2015 |
| Safety | CB: IEC 62368-1: 2014+A11, CE-LVD: EN 62368-1: 2014/A11: 2017, BIS: IS 13252 (Part 1): 2010/IEC 60950-1: 2005, LOA: IEC/EN 60950-1 |
| Environment | CE-RoHS: 2011/65/EU, WEEE: 2012/19/EU, Reach: Regulation (EC) No 1907/2006 |
| Protection | IP67: IEC 60529-2013,IK10: IEC 62262:2002 |

▪ Typical Application

Hikvision products are classified into three levels according to their anti-corrosion performance. Refer to the following description to choose for your using environment.

This model has NO SPECIFIC PROTECTION

| Level | Description |
|----------------------|--|
| Top-level protection | Hikvision products at this level are equipped for use in areas where professional anti-corrosion protection is a must. Typical application scenarios include coastlines, |

| | |
|------------------------|--|
| | docks, chemical plants, and more. |
| Moderate protection | Hikvision products at this level are equipped for use in areas with moderate anti-corrosion demands. Typical application scenarios include coastal areas about 2 kilometers (1.24 miles) away from coastlines, as well as areas affected by acid rain. |
| No specific protection | Hikvision products at this level are equipped for use in areas where no specific anti-corrosion protection is needed. |

▪ **Available Model**





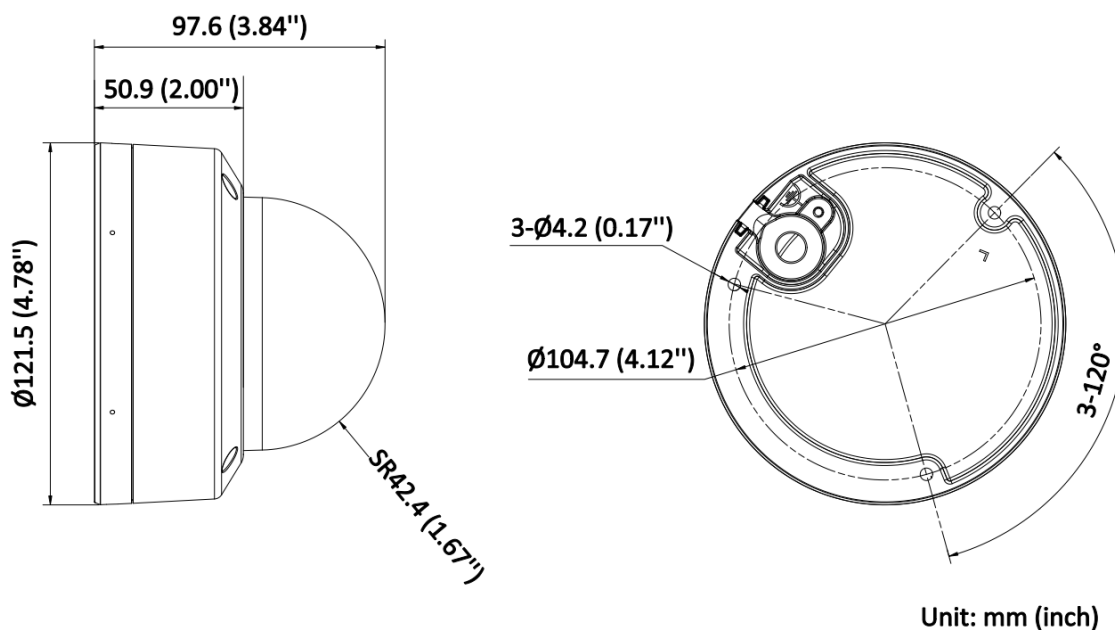











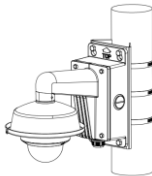
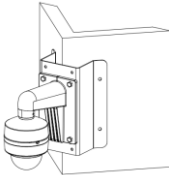

- DS-2CD2163G2-LI(2.8mm)
- DS-2CD2163G2-LI(4mm)
- DS-2CD2163G2-LIS2U(2.8mm)
- DS-2CD2163G2-LIS2U(4mm)
- DS-2CD2163G2-LIS2U(2.8mm)(Black)

▪ **Dimension**



▪ **Accessory**

▪ **Optional**

| DS-1272ZJ-120 Wall mount | DS-1272ZJ-120B Wall mount | DS-1271ZJ-120 Pendant Mount | DS-1275ZJ-SUS Vertical pole mount | DS-1276ZJ-SUS Corner mount |
|---|---|---|---|---|
|  |  |  |  |  |
|  |  |  |  |  |
| DS-1280ZJ-DM46 Junction box | DS-2280ZJ-WA120 Junction box | DS-2210ZJ-WA-120 Pendant Mount | DS-2200ZJ-WA-120 Wall mount | DS-2200ZJ-WAJ-120 Wall mount |
|  |  |  |  |  |
|  |  |  |  |  |

Headquarters

No.555 Qianmo Road, Binjiang District,
Hangzhou 310051, China
T +86-571-8807-5998
www.hikvision.com



Follow us on social media to get the latest product and solution information.

