

## iDS-2CD70C5G0/H-AP 12 MP Box Network Camera



Hikvision has been dedicated to develop products with security since established. Hikvision always follows security by design principle and has adopted many methods of security technologies into our product development lifecycle, including terminal security, data security, application security, network security, and privacy protection. In the meantime, the security technologies used by Hikvision are all in compliance with local applicable laws and safety regulations. These security measures could enhance product's cyber security protection capability and protect your devices as well as your data from malicious cyber attacks.

- Hikvision Embedded Open Platform 2.0 for 3rd party integration
- Supports 2 Tops computing power, 150 MB system memory, 800 MB smart RAM, and 2 GB eMMC storage for sharing resources
- High quality imaging with 12 MP resolution
- Excellent low-light performance via DarkFighter technology
- Clear imaging against strong back light due to DWDR technology
- Efficient H.265+ compression technology to save bandwidth and storage
- 5 streams to meet a wide variety of applications
- Built-in microphone for real-time audio security

## ▪ Specification

Camera	
Image Sensor	1/1.7" Progressive Scan CMOS
Max. Resolution	4000 × 3000
Min. Illumination	Color: 0.009 Lux @ (F1.2, AGC ON),B/W: 0.0009 Lux @ (F1.2, AGC ON),B/W: 0 Lux with IR
Shutter Time	1 s to 1/100,000 s
Day & Night	IR cut filter
Lens	
Lens Mount	CS mount
HEOP	
Open Resources	Memory: 150 MB, Smart RAM: 800 MB, eMMC: 2 GB
Computing Power	2 TOPS
Open Capability	HEOP 2.0 OpendevSDK
Deep Learning Structure	Caffe,PyTorch,TensorFlow
Programming Language	C,C++
Video	
Main Stream	50 Hz: 25 fps (4096 × 2160, 3840 × 2160, 3072 × 1728, 2560 × 1440, 1920 × 1080, 1280 × 720) 60 Hz: 30 fps (4096 × 2160, 3840 × 2160, 3072 × 1728, 2560 × 1440, 1920 × 1080, 1280 × 720) 50 Hz: 25 fps (4000 × 3000) 60 Hz: 30 fps (4000 × 3000)
Sub-Stream	50 Hz: 25 fps (704 × 576, 640 × 480) 60 Hz: 30 fps (704 × 480, 640 × 480)
Third Stream	50 Hz: 25 fps (1920 × 1080, 1280 × 720, 704 × 576, 640 × 480) 60 Hz: 30 fps (1920 × 1080, 1280 × 720, 704 × 480, 640 × 480)
Fourth Stream	50 Hz: 25 fps (704 × 576, 640 × 480) 60 Hz: 30 fps (704 × 480, 640 × 480)
Fifth Stream	50 Hz: 25 fps (704 × 576, 640 × 480) 60 Hz: 30 fps (704 × 480, 640 × 480)
Video Compression	Main stream: H.265+/H.265/H.264+/H.264, Sub-stream: H.265/H.264/MJPEG, Third stream: H.265/H.264, Fourth stream: H.265/H.264/MJPEG, Fifth stream: H.265/H.264/MJPEG
Video Bit Rate	32 Kbps to 16 Mbps
H.264 Type	Baseline Profile,Main Profile,High Profile
H.265 Type	Main Profile
Bit Rate Control	CBR,VBR
Scalable Video Coding (SVC)	H.264 and H.265 encoding
Region of Interest (ROI)	4 fixed regions for each stream
Target Cropping	Yes

Audio	
Audio Type	Mono sound
Audio Compression	G.711/G.722.1/G.726/MP2L2/PCM/MP3/AAC-LC
Audio Bit Rate	64 Kbps (G.711ulaw/G.711alaw)/16 Kbps (G.722.1)/16 Kbps (G.726)/32 to 192 Kbps (MP2L2)/8 to 320 Kbps (MP3)/16 to 64 Kbps (AAC-LC)
Audio Sampling Rate	8 kHz/16 kHz/32 kHz/44.1 kHz/48 kHz
Environment Noise Filtering	Yes
Network	
Protocols	TCP/IP, ICMP, HTTP, HTTPS, FTP, DHCP, DNS, DDNS, RTP, SRTP, RTSP, RTCP, PPPoE, NTP, UPnP, SMTP, SNMP, IGMP, 802.1X, QoS, IPv6, UDP, Bonjour, WebSocket, WebSockets
Simultaneous Live View	Up to 20 channels
API	Open Network Video Interface (Profile S, Profile G),ISAPI,SDK,ISUP
User/Host	Up to 32 users 3 user levels: administrator, operator, and user
Security	Password protection, complicated password, HTTPS encryption, 802.1X authentication (EAP-TLS, EAP-LEAP, EAP-MD5), watermark, IP address filter, basic and digest authentication for HTTP/HTTPS, WSSE and digest authentication for Open Network Video Interface, RTP/RTSP OVER HTTPS, Control Timeout Settings, Security Audit Log, TLS 1.1, TLS 1.2, TLS 1.3
Client	iVMS-4200,Hik-Connect
Web Browser	Plug-in required live view: IE 10, IE 11, Plug-in free live view: Chrome 57.0+, Firefox 52.0+, Edge 89+, Safari 11+, Local service: Chrome 57.0+, Firefox 52.0+, Edge 89+
Network Storage	NAS (NFS, SMB/CIFS),Auto Network Replenishment (ANR), Together with high-end Hikvision memory card, memory card encryption and health detection are supported.
Image	
Image Parameters Switch	Yes
Image Settings	Rotate mode,saturation,brightness,contrast,sharpness,AGC,white balance,adjustable by client software or web browser
Day/Night Switch	Day,Night,Auto,Schedule,Alarm Trigger
Wide Dynamic Range (WDR)	Digital WDR
Image Enhancement	BLC,HLC,3D DNR,Defog
Privacy Mask	8 programmable polygon privacy masks, mask color or mosaic configurable
Picture Overlay	LOGO picture can be overlaid on video with 128 × 128 24 bit bmp format.
Interface	
Video Output	1 Vp-p Composite Output (75 Ω/CVBS) (Only for debugging)
Ethernet Interface	1 RJ45 10 M/100 M/1000 M self-adaptive Ethernet port
On-Board Storage	Built-in memory card slot, support microSD/microSDHC/microSDXC card, up to 256 GB
Built-in Microphone	Yes,1 built-in microphone
Audio	1 input (line in), 3.5 mm connector, three-contact, max. input amplitude: 3.3 Vpp, input impedance: 4.7 KΩ, interface type: non-equilibrium, 1 output (line out), 3.5 mm connector, three-contact, max. output amplitude: 3.3 Vpp, output impedance: 100 Ω, interface type: non-equilibrium, mono sound
Alarm	2 inputs, 2 outputs (max. 24 VDC/24 VAC, 1 A)

RS-485	1 RS-485 (Half duplex, HIKVISION, Pelco-P, Pelco-D, self-adaptive)
Reset Key	Yes
Power Output	12 VDC, max. 100 mA
<b>Event</b>	
Basic Event	Motion detection,video tampering alarm,network disconnected,IP address conflict,illegal login,HDD full,HDD error,abnormal restart,video quality diagnosis
Smart Event	scene change detection,audio exception detection,defocus detection
Linkage	Upload to FTP/NAS/memory card,notify surveillance center,send email,trigger alarm output,trigger recording,trigger capture,audible warning
<b>General</b>	
Power	12 VDC $\pm$ 20%, 0.7 A, max. 8.4 W,three-core terminal block,reverse polarity protection, 24 VAC $\pm$ 20%, 0.59 A, max. 8.0 W, PoE: IEEE 802.3af, Type 1, Class 3, 36 V to 57 V, 0.26 A to 0.17 A, max. 9.2 W
Material	Aluminum alloy body
Dimension	142.5 mm $\times$ 69.8 mm $\times$ 68 mm (5.61" $\times$ 2.75" $\times$ 2.68")
Package Dimension	315 mm $\times$ 140 mm $\times$ 140 mm (12.4" $\times$ 5.51" $\times$ 5.51")
Weight	Approx. 755 g (1.66 lb.)
With Package Weight	Approx. 1120 g (2.47 lb.)
Storage Conditions	-40 °C to 60 °C (-40 °F to 140 °F). Humidity 95% or less (non-condensing)
Startup and Operating Conditions	-30 °C to 60 °C (-22 °F to 140 °F). Humidity 95% or less (non-condensing)
Language	33 languages: English, Russian, Estonian, Bulgarian, Hungarian, Greek, German, Italian, Czech, Slovak, French, Polish, Dutch, Portuguese, Spanish, Romanian, Danish, Swedish, Norwegian, Finnish, Croatian, Slovenian, Serbian, Turkish, Korean, Traditional Chinese, Thai, Vietnamese, Japanese, Latvian, Lithuanian, Portuguese (Brazil), Ukrainian
General Function	Heartbeat,one-key reset,mirror,password protection,pixel counter,anti-banding
<b>Approval</b>	
EMC	CE-EMC: EN 55032: 2015, EN 61000-3-2:2019, EN 61000-3-3: 2013+A1:2019, EN 50130-4: 2011 +A1: 2014, RCM: AS/NZS CISPR 32: 2015, IC: ICES-003: Issue 7, KC: KN32: 2015, KN35: 2015
Safety	UL: UL 62368-1, CB: IEC 62368-1: 2014+A11, CE-LVD: EN 62368-1: 2014/A11: 2017, BIS: IS 13252 (Part 1): 2010/IEC 60950-1: 2005, LOA: IEC/EN 60950-1
Environment	CE-RoHS: 2011/65/EU, WEEE: 2012/19/EU, Reach: Regulation (EC) No 1907/2006

▪ **Physical Interface**

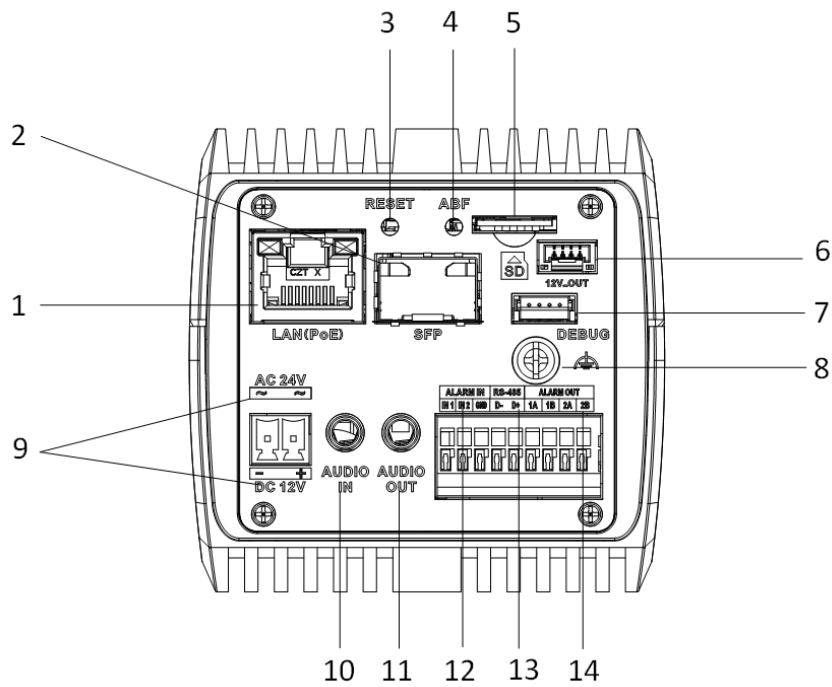

\*Note: The interface varies depending on the model. Please refer to the actual product.

▪ **Available Model**

iDS-2CD70C5G0/H-AP



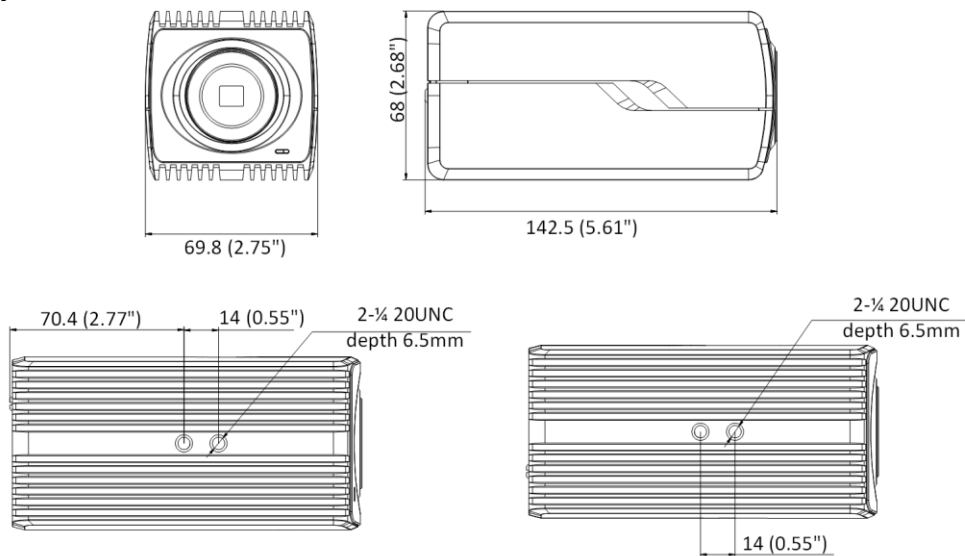











▪ **Dimension**



Unit: mm (inch)

▪ **Accessory**

▪ **Optional**

<b>DS-1292ZJ</b> Wall mount	<b>DS-1293ZJ</b> Wall mount	<b>DS-1299ZJ</b> Pendant Mount	<b>DS-1269ZJ</b> Pendant Mount	<b>DS-1214ZJ</b> Horizontal pole mount
				
<b>DS-1233ZJ</b> Pendant Mount	<b>DS-1332HZ</b> Indoor Housing	<b>DS-1331HZ-W</b> Outdoor Housing	<b>HV3816P-8MPIR</b> Mega-pixel P-Iris Lens	<b>HV1140P-8MPIR</b> Mega-pixel P-Iris Lens
				
<b>HV3816D-8MPIR</b> Mega-pixel Auto-Iris Lens	<b>HV1140D-8MPIR</b> Mega-pixel Auto-Iris Lens	<b>HV0733D-6MP</b> Mega-pixel Auto-Iris Lens	<b>HV0415D-MP</b> Mega-pixel Auto-Iris Lens	<b>DS-2202ZJ</b> Wall mount
				

**Headquarters**

No.555 Qianmo Road, Binjiang District,  
Hangzhou 310051, China  
T +86-571-8807-5998  
www.hikvision.com



Follow us on social media to get the latest product and solution information.

