



Unboxing and Tutorial Analog PIR System

Title:	Unboxing and Tutorial Analog PIR System	Version:	v1.0	Date:	3/28/2020
Product:	Cameras, DVR			Page:	of 14

Preparation

1. Camera mode: DS-2CE12DFT-PIRXOF
2. DVR mode: DS-7216HUHI-K2 4.21.000 build190722

Unboxing and Tutorial Analog PIR System

1. Topology

When build an Analog PIR system, you will need DVR and PIR cameras.

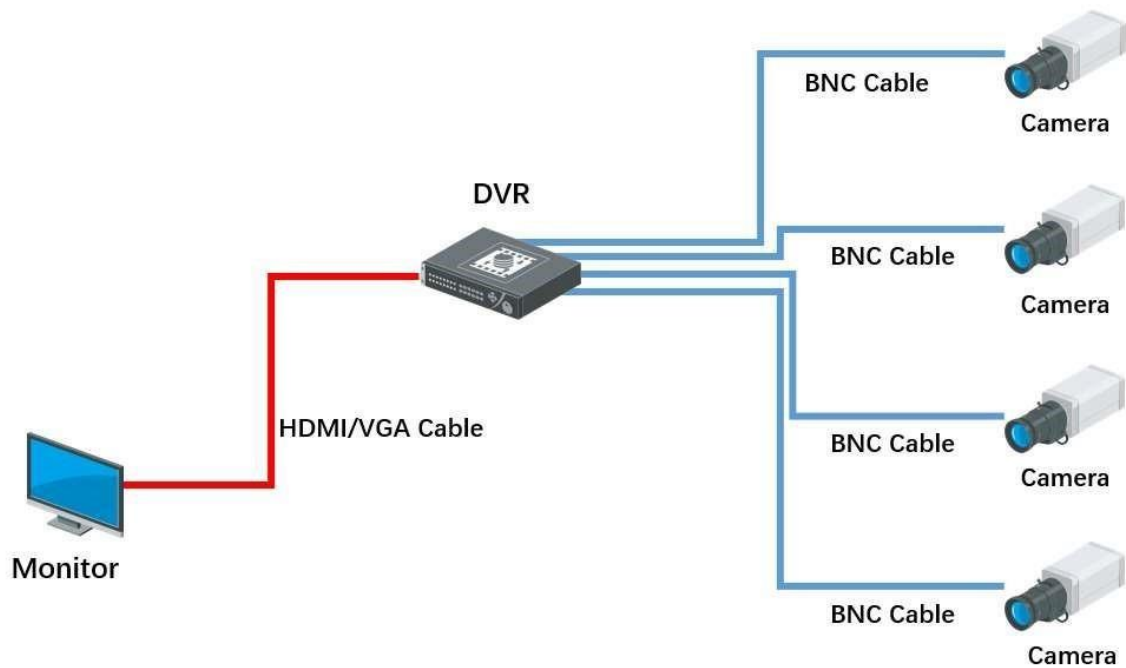

2. Unboxing

Take out the DVR, accessories and cameras from the box, prepare the waterproof tape, HDD, network cables, HDMI/VGA cable and monitor.

Title:	Unboxing and Tutorial Analog PIR System	Version:	v1.0	Date:	3/28/2020
Product:	Cameras, DVR			Page:	of 14



3. Installation

- a) Paste the Drill Template to the wall or ceil and follow the prompt to drill screw hole.



- b) Drive in the expansion screw to the screw hole

Title:	Unboxing and Tutorial Analog PIR System	Version:	v1.0	Date:	3/28/2020
Product:	Cameras, DVR			Page:	of 14



c) Fix the camera to the wall or ceil with screw.



d) Loosen the screws and adjust the lens angel to modify device angel.

Title:	Unboxing and Tutorial Analog PIR System	Version:	v1.0	Date:	3/28/2020
Product:	Cameras, DVR			Page:	of 14



e) Insert the BNC interface with the BNC cable

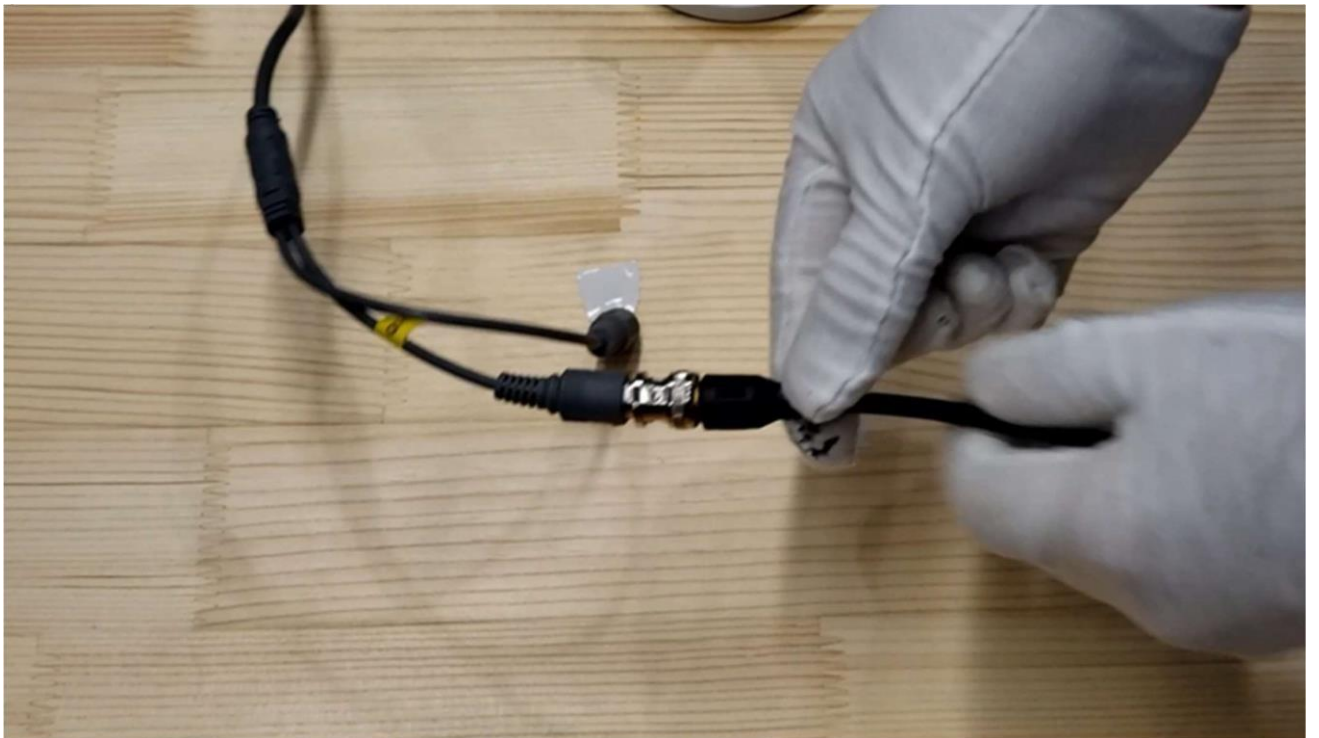

f) Wrap waterproof tape around the BNC cable and power cable

Title:	Unboxing and Tutorial Analog PIR System	Version:	v1.0	Date:	3/28/2020
Product:	Cameras, DVR			Page:	of 14



Note: Waterproof protection is a must!

g) Remove protective film



4. Install HDD into DVR

a) Loosen screws and remove cover of DVR

Title:	Unboxing and Tutorial Analog PIR System	Version:	v1.0	Date:	3/28/2020
Product:	Cameras, DVR			Page:	of 14



b) Connect cables to HDD

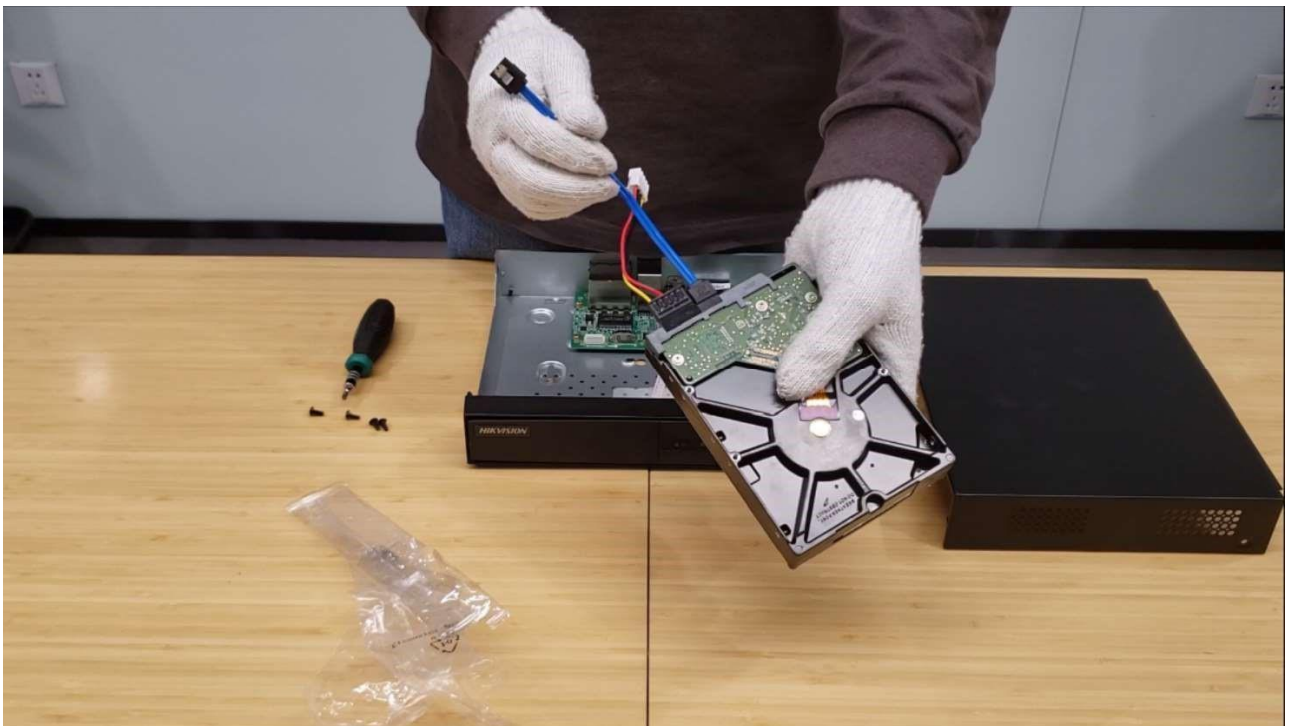

c) Fix HDD to DVR bottom

Title:	Unboxing and Tutorial Analog PIR System	Version:	v1.0	Date:	3/28/2020
Product:	Cameras, DVR			Page:	of 14



d) Connect cables to DVR



e) Install the cover back

Title:	Unboxing and Tutorial Analog PIR System	Version:	v1.0	Date:	3/28/2020
Product:	Cameras, DVR			Page:	of 14



Note: The HDD model should in the HDD Compatible List

5. Connection

- a) Connect the cameras to the BNC interfaces of the DVR with the coaxial cables.



- b) Connect the DVR to a monitor with the HDMI cable.
c) Connect the power adaptor and the mouse.

Title:	Unboxing and Tutorial Analog PIR System	Version:	v1.0	Date:	3/28/2020
Product:	Cameras, DVR			Page:	of 14



6. Configuration

1.1 PIR Function Configuration

The new DFT-PIRXO series camera could not only provide 7*24 full-color monitoring, but also a combination of PIR function together with sound-light alarm.

The connected DVR should be –M series v4.20.200, and general DVR v 4.21.000. If it's connected to other DVR, Trigger Alarm Output will be enabled automatically and will not be changed.

a) Go to MAIN MENU-SMART LIGHT to set the details.

Firstly, Threshold means the time to turn on or turn off the light, the lower threshold is, the later to switch.

Secondly, the level means the brightness of light, the higher level is, the higher brightness the light is. Normally, the level parameter is 5.

Thirdly, Smart light mode could be adjust to mode 1 and mode 2. Mode 1 could induce brightness by prolonging the exposure time. And mode 2 is the normal model.

Title:	Unboxing and Tutorial Analog PIR System	Version:	v1.0	Date:	3/28/2020
Product:	Cameras, DVR			Page:	of 14

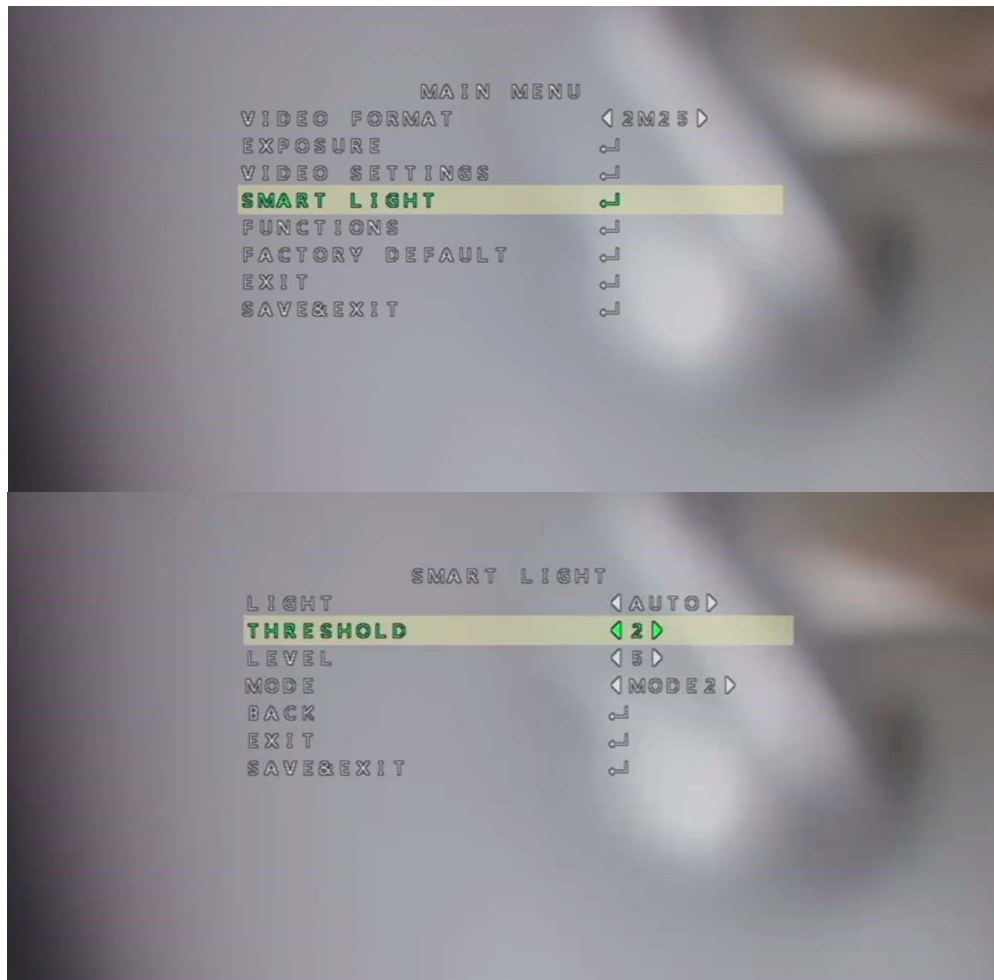

b) Go to MAIN MENU- FUNCTIONS to set the details

PIR Level which ranges from 1~5, which represents the sensitivity. The higher the value is, the easier the PIR event will be triggered;

PIR DET MODE could be selected as OUTDOOR (default) and INDOOR. Indoor mode is more sensitive together with a rapid response speed, which is suitable for a small monitoring environment. While the outdoor mode has a more precise response to human, influencing factors like hot wind and sunshine could be filtered efficiently, which is suitable for large-scale monitoring;

ALARM TIME (5s, 10s, 15s, 30s, and 60s optional) is the time per event lasts. If a certain event is triggered and you set the time to 5s, the alarm will be stopped after 5s; if there is a new alarm triggered before the former alarm stops, the alarm will last for a new 5s regardless of the former one.

Title:	Unboxing and Tutorial Analog PIR System	Version:	v1.0	Date:	3/28/2020
Product:	Cameras, DVR			Page:	of 14

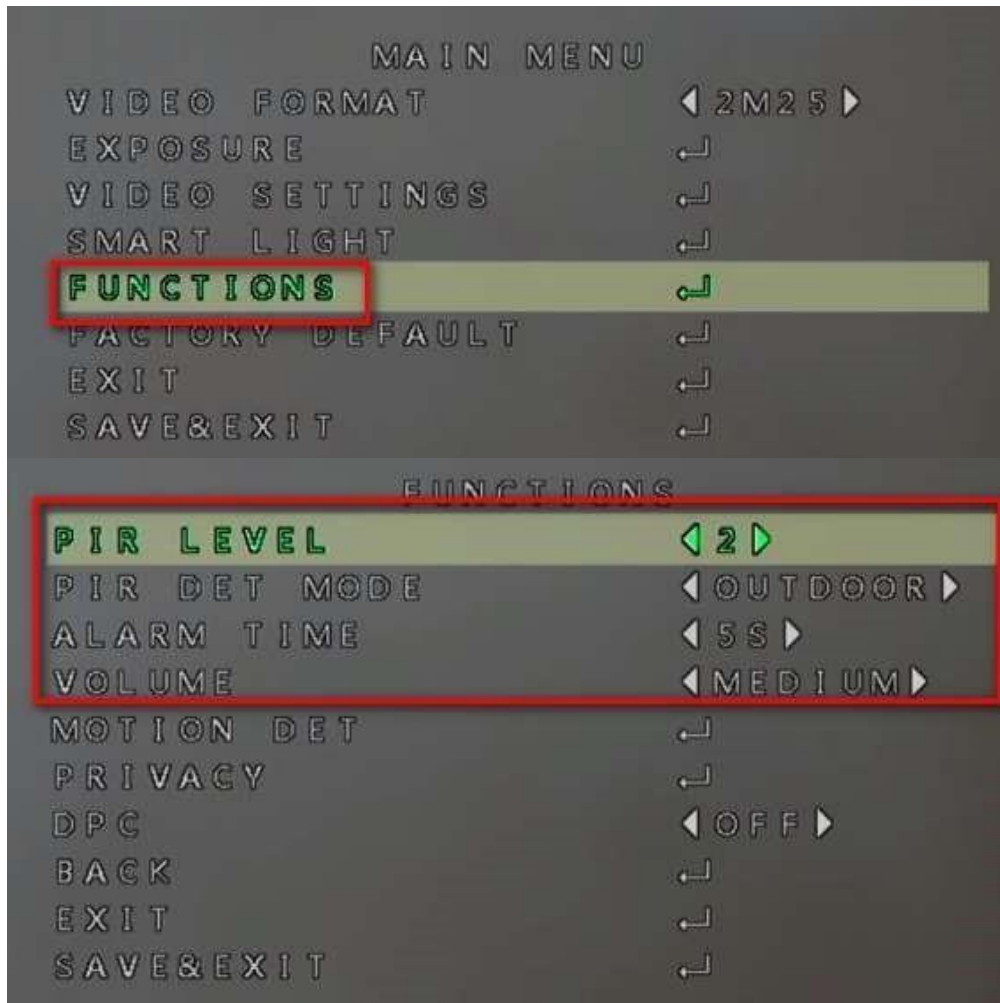

1.2 Linkage Action Configuration

In DVR local configuration interface configuration-Event-Smart Event, you will find there are three new options in the linkage action of the events, which are respectively flashing light alarm, alarm out alarm (-PIRXO has a physical alarm out interface) and sound alarm ;

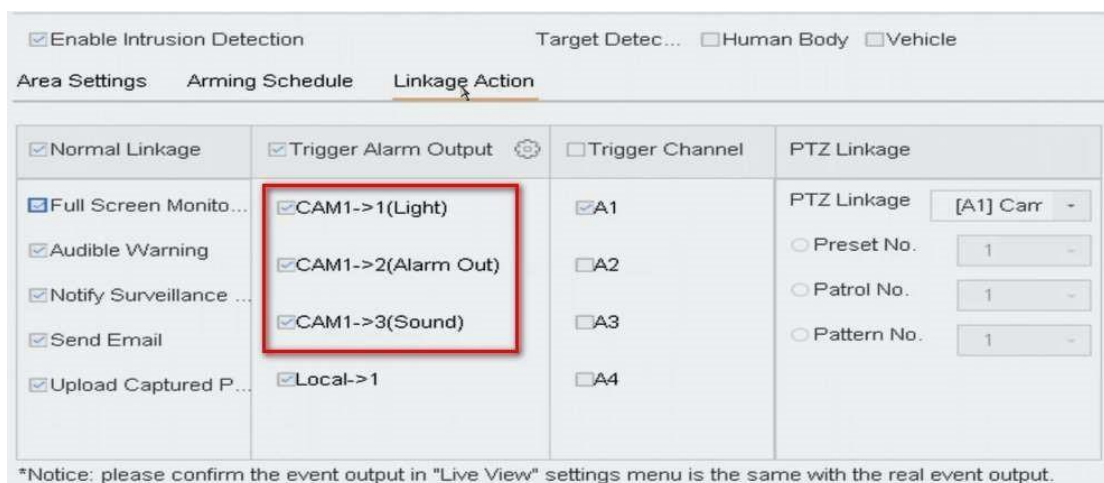

Title:	Unboxing and Tutorial Analog PIR System	Version:	v1.0	Date:	3/28/2020
Product:	Cameras, DVR			Page:	of 14

Click the setting icon to set the arming schedule.

If you have succeed in configuring the sound-light alarm, the next time an event is detected, it would keep flashing in blue & red and beeping then stop.

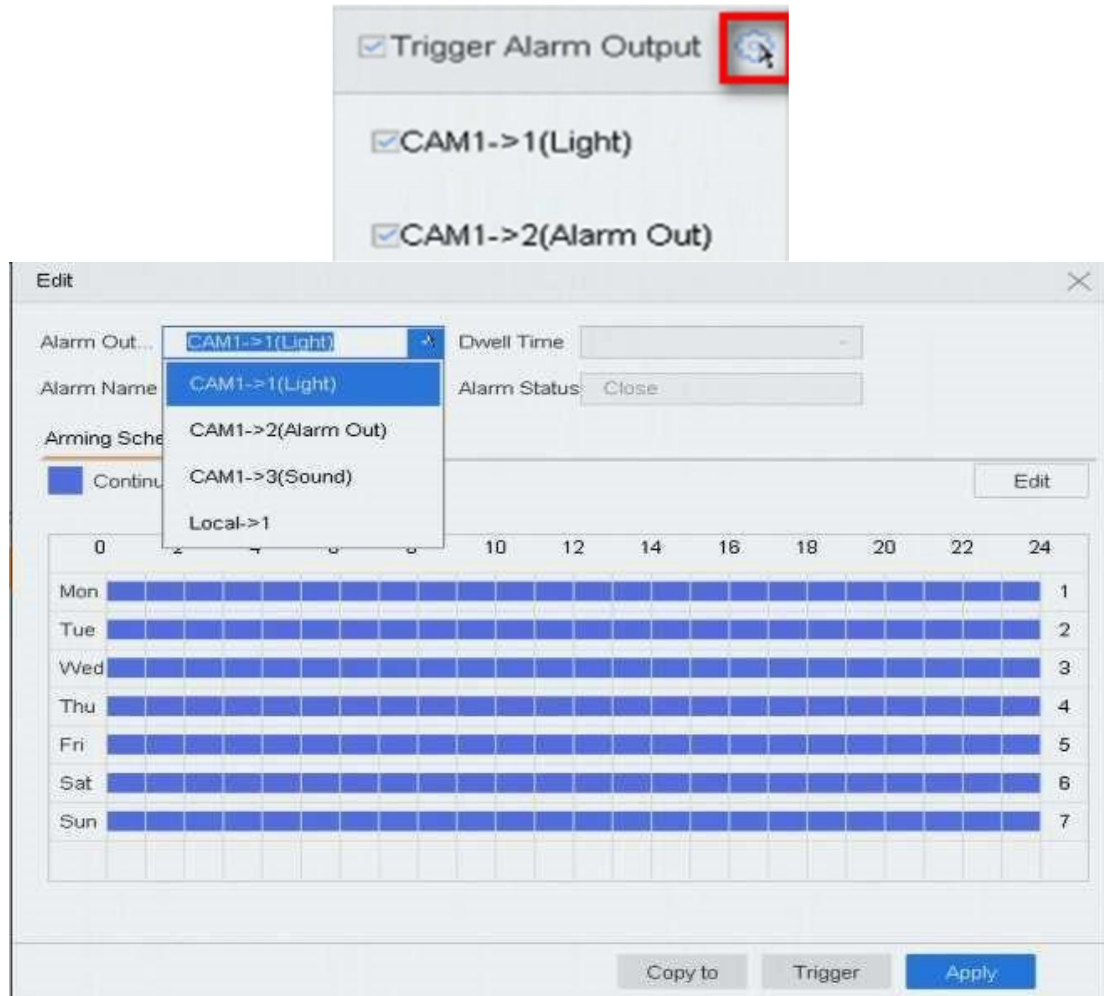

Title:	Unboxing and Tutorial Analog PIR System	Version:	v1.0	Date:	3/28/2020
Product:	Cameras, DVR			Page:	of 14

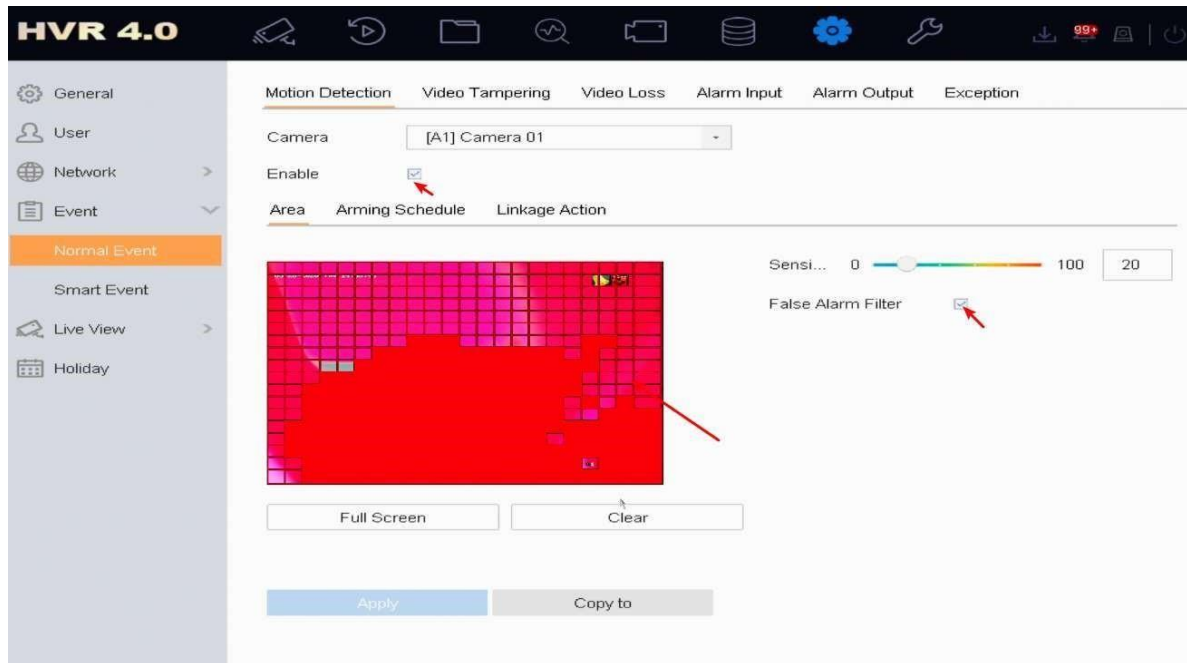

7. Checklist

No.	Details	Yes/No?
1	Are the camera coaxial cable and power cord waterproof?	
2	Are all cameras live view normally?	
3	Are the siren and flashing alarm normally?	
4	Is the status of HDD normal?	
5	Are playback of all camera videos normal?	

8. FAQ

a) Camera PIR detection function oversensitive

Check the installation, and avoid to install the PIR camera directly towards the window or door, while the hot airflow/thermal resource at the window/door or the human body movement itself will lead to a camera PIR detection false triggering.

b) Camera PIR detection function insensitive

- Within the PIR camera detection coverage area, kindly advice to deploy the camera in the vertical position of the human body moving direction. And do not put the partitions like large furniture, bonsai

Title:	Unboxing and Tutorial Analog PIR System	Version:	v1.0	Date:	3/28/2020
Product:	Cameras, DVR			Page:	of 14

and so on in the PIR camera detection area which may isolate the target infrared radiation and can't get an effective PIR detection.

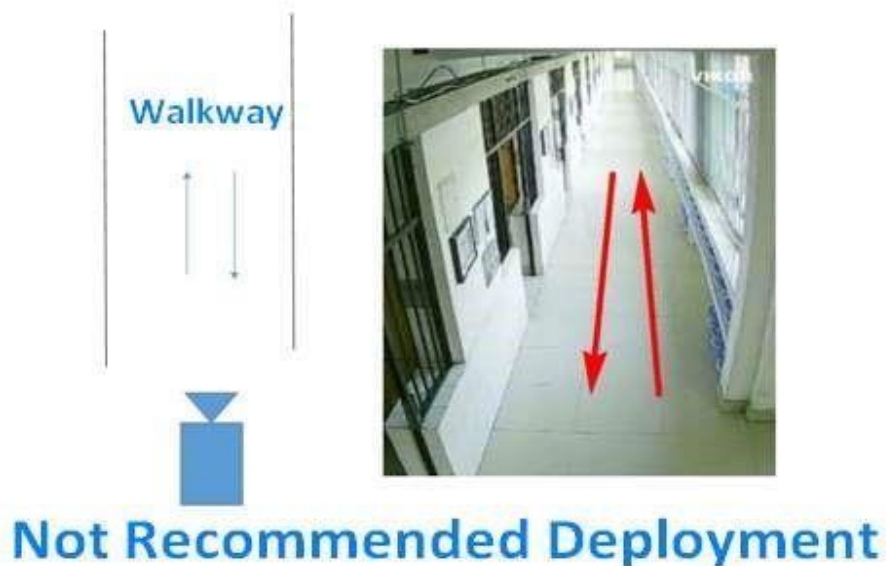

c) Why my DVR don't have any light or sound function in Linkage Action?

- Please check the firmware of DVR, must above 4.21.000 of K series, 4.30.101 of F series, so that you can set the linkage action.

d) Any advice of installation?

- The recommend installation height of the PIR camera is about 2.5 meter, which will farthest avoid the false triggering caused by the animals on the ground and the hot airflow/thermal resource. And the PIR camera should keep a distance/far away from heat recourse like Air condition, Refrigerator, Stove and so on.



See Far, Go Further