

A nighttime cityscape with a digital overlay of glowing lines and nodes. The background shows a city skyline with illuminated buildings. Overlaid on this are numerous vertical lines of varying colors (blue, purple, pink) that end in small glowing circles. These lines are interconnected by a network of thin, curved lines at the bottom. A large, semi-transparent blue arc is visible in the upper right corner. The overall aesthetic is futuristic and technological.

PRODUCT QUICK GUIDE

CCTV SOLUTION PRODUCTS

2021 H1

HIKVISION[®]

CONTENTS

001

Network Camera

- 002 DeepinView Series
- 009 Ultra Series
- 025 Special Series

028

PTZ Dome Camera

- 029 Ultra Series
- 038 Special Series

041

Panoramic Camera

- 042 PanoVu Series
- 046 Fisheye Series

048

Explosion-Proof & Anti-Corrosion Series

- 049 Explosion-Proof Series
- 053 Anti-Corrosion Series

055

NVR

- 056 DeepinMind Series
- 061 Ultra Series
- 065 Pro Series
- 069 Workstation Series

071

Network Storage

- 072 Hybrid SAN
- 076 Cluster Storage

078

Data Center

- 079 DeepinMind Server
- 083 General Purpose Server

085

Thermal

- 086** HeatPro Series
- 088** Security Group Cameras
- 093** Thermographic Group Products
- 097** Temperature Screening Products

100

Commercial Display

- 101** LCD Video Wall
- 104** LED Display
- 110** Interactive Display
- 111** Digital Signage

113

Decoder

- 114** Decoder

116

Video Wall Controller

- 117** Video Wall Controller

118

Software

- 119** HikCentral Professional
- 120** HikCentral Enterprise-Commercial
- 121** HikCentral Enterprise-Retail
- 122** HikCentral Enterprise-Industrial
- 123** HikCentral Enterprise-Education
- 124** HikCentral Master
- 125** HikCentral-Workstation
- 127** Blazer Pro

128

Accessories

174

DORI Distance

DEEP LEARNING

Deep Learning is the new buzzword in science and technology.

A technology with innumerable applications, Deep Learning is beginning to influence many aspects of our lives. When it comes to the field of video & image analytics, Deep Learning applications have grown rapidly in recent years, benefiting from sophisticated algorithms based on neural networks. Now, Hikvision's DeepinView Series Cameras and DeepinMind Series NVRs and Servers will lead the way in this new world of security technology by making invisible intelligence visible for users, and then putting that intelligence to good use.

And what can Hikvision's Deep Learning products do? Facial Detection is only the beginning. With analytics that take business solutions into the next century, and with automated alarm accuracy above 90%, this technology is a step above and beyond video security as we know it.

Hikvision's Deep Learning technology filters insignificant objects and movements in a scene that would trigger conventional alarm systems. Vehicle data gets recorded and shapes the database to perform numerous security functions. People Counting systems give businesses an edge in marketing and conversion rates.

Across the board, Hikvision's Deep Learning Solutions are adding value on multiple levels – today and tomorrow.



Facial Recognition



Vehicle Identification



Human & Vehicle
Classification (AcuSense)



People Counting



Hard Hat Detection



More



ULTRA-LOW LIGHT

DarkFighter & DarkFighterX

With the deepening of security awareness and the building boom of safe cities, high-quality video security has become a basic requirement. Since night hours make up almost half of the security recording, and since most crime happens at night, improving low-light video quality is the most critical problem in the video security industry today.

DarkFighter – Stunning color video in near darkness

Featuring a large HD progressive scan CMOS sensor, Hikvision's DarkFighter Technology captures excellent color imaging in extremely dark environments – even down to 0.002 lux – and automatically switches to monochrome by removing the IR filter to boost sensitivity when illumination is lower than 0.002 lux. All the while, DarkFighter maintains superlative image quality.

DarkFighterX – Dual-sensor imaging for full color images

DarkFighterX's technology is based on the retinal imaging that human eyes use to process color and brightness. This human-like technology features an innovative dual-sensor design – one sensor for IR imaging that guarantees image brightness, the other sensor for visible light that guarantees vivid color. These signals are then combined into one bright, full-color image.

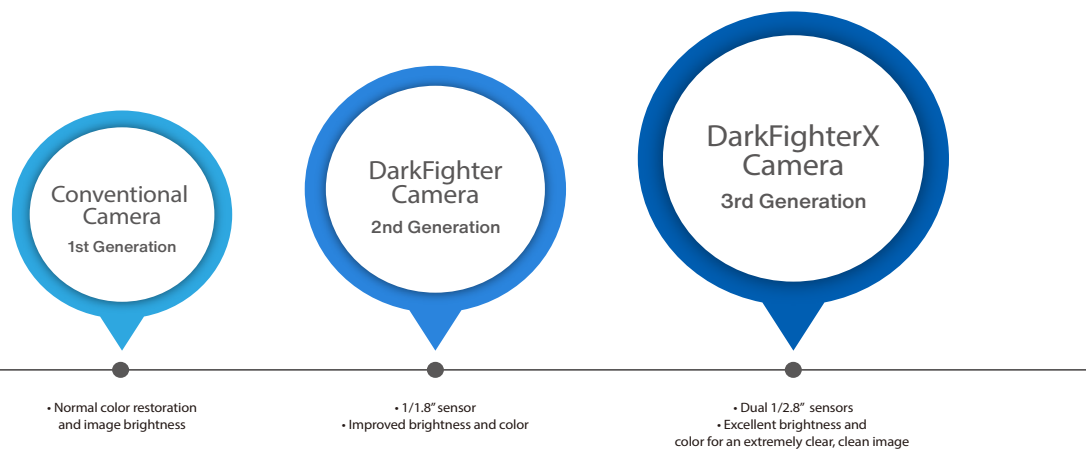

HIKVISION ACUSENSE

A sense of safety is one of the most basic human needs, and that goes for both personal and property safety. And this is exactly why people install security systems in their homes and businesses.

Compared to conventional sensor-based alarm systems, a video-based security system that utilizes cameras has several advantages: the ability to watch events in real-time over the live feed, capture critical data around those events, and provide solid and accurate evidence for law enforcement.

AcuSense technology adds a touch of intelligence to Hikvision's popular cameras and video recorders, making them perfect for an accessible and intelligent security system. Based on Deep Learning technology, AcuSense helps you focus on human and vehicle events in two ways: alarms will only trigger when the preset type of intrusion takes place, and video footage is sorted by target-type categories for easier searching through recorded footage. Strobe light and audio alarms serve as virtual security guards, protecting users from potential risks by warding off intruders. When emergencies occur, related videos are classified into human and vehicle categories for quick search and retrieval.

Sophisticated, highly effective, and affordable, the AcuSense solution provides SMB owners and operators an intelligent and easy-to-use protection system for their property and assets, while helping resellers build a uniquely competitive go-to-market proposition.

AcuSense

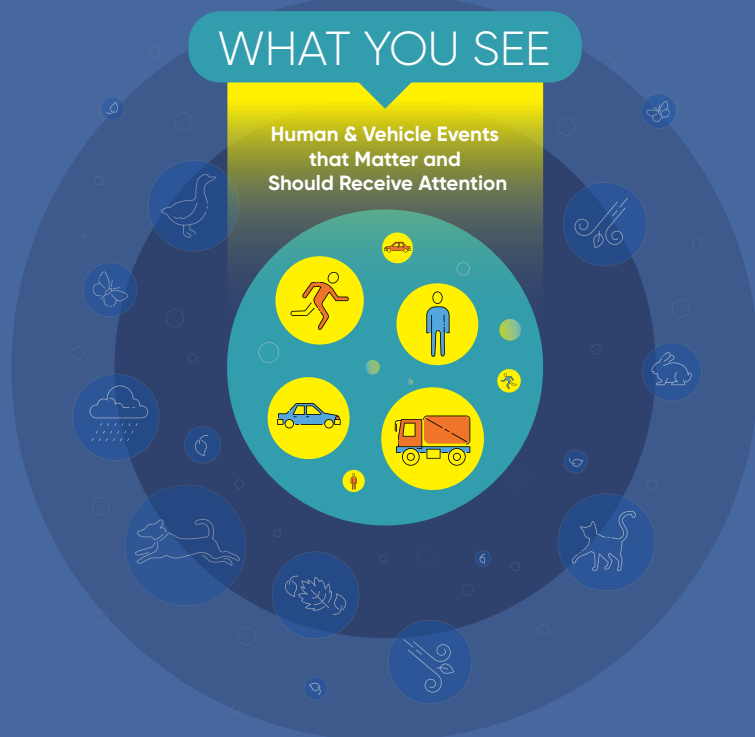

FOCUS
and ACT

AcuSense
Technology



ColorVu
Series Camera



24 Hours \times 7 Colorful Imaging

View in color,
Even in darkness

HIKVISION COLORVU

Darkness provides cover for theft, trespassing, and other crimes. When incidents occur at night, dim, low-quality images from conventional cameras miss or lose critical details. Cameras with infrared LEDs are able to provide extra light for clearer image, but in black-and-white.

But now, imagine capturing vivid, colorful details – such as the color of people’s clothing or of a car – even in total darkness. Hikvision ColorVu Technology makes this possible.

Hikvision ColorVu Technology enables front-end products to capture details in low light with three advantages: advanced hardware, superior ISP algorithm, and reliable quality control. ColorVu technology employs two specific breakthroughs in hardware technology: advanced lenses and powerful sensors. These lenses reach up to F1.0, allowing more light to enter and thereby increasing image brightness. Next, high-sensitivity sensors vastly improve the utilization of that light. The frontier ISP algorithm realizes precise color rendition to produce accurate colorful images. Moreover, active alignment technology guarantees the focusing performance of lenses in the mass production of ultra-high definition ColorVu products, resulting in superlative quality control.

Extreme light conditions are also taken into consideration in the design process. Some cameras are equipped with warm, natural-looking supplemental lighting. This way, when there is no light source whatsoever – even starlight or street lights – they can guarantee colorful imaging. For most scenes, the environmental light is bright enough for ColorVu cameras to render vivid color without supplemental lighting.

ColorVu

LIGHTFIGHTER

140 dB WDR

Hikvision is set to reach new heights in extremely high contrast imaging with the ultra-high 140 dB WDR “LightFighter” technology for exceptional, industry-leading visibility in brightly lit or high-contrast environments. The result of this cutting-edge advancement is crystal-clear, detail-rich images with true color reproduction in lighting conditions that would defeat conventional WDR technology.

The key to the performance of the LightFighter technology is the industry-leading WDR system that allows cameras to record greater scene details even where the intensity of illumination varies considerably, such as backlighting when very dark and very bright areas appear simultaneously in the field of view. The 140 dB WDR in the LightFighter offers 100 times more powerful enhancement than the conventional 120 dB WDR systems.

LightFighter is particularly suited to intense backlight situations, and is the ideal technology for cameras pointing towards windows and entrance doors.



4K

With the development of 4K technology quickly coming into focus, opportunities to use this technology in security will continue to grow. As a leading IoT solution provider with video as its core competency, Hikvision has paid close attention to the rise of 4K and has launched a total 4K system to harness this technology in the global security industry.

Without complementary 4K components, such as monitors and NVRs, 4K cameras cannot be used to their full potential, and therefore have little practical use in security applications.

By building a total system – complete with cameras, NVRs, etc. – Hikvision strives to provide a system that is more helpful and more useful to its customers. The Hikvision 4K system, which comes equipped with a variety of smart functions, satisfies the security industry's need for advanced analytics with ultra-high resolution video.

Recently, Hikvision has released an 8K camera which monitors large scenes over long distances. This one camera does the work that once required several cameras, thus reducing installation and maintenance costs.



Network Camera

002 DeepinView Series

009 Ultra Series

025 Special Series



DeepinView Series Network Cameras

Deeper Intelligence for Expansive Security

- High performance and intelligent products with Deep Learning algorithms and high performance GPU
- The 2nd-generation DeepinView Series supports multiple algorithms in one device for a variety of scenarios. Additionally, it integrates multiple lenses to simultaneously capture sharp details and the big picture for extensive situational awareness.
- People counting, dual-lens people counting, multi-target-type detection, ANPR, vehicle appearance analysis, hard hat detection, facial recognition, perimeter protection, and queue management.
- DeepinView Series products are edge nodes in the AI Cloud architecture, focusing on multidimensional data collection and front-end intelligent processing.









9 series







Model	IDS-2PT9A144MXS-D/T2(1352/6)
Image	 DeepinView
Image Sensor	1/1.8" progressive scan CMOS
Max. Resolution	2560 × 1440
Video Compression	H.265+/H.265/H.264+/H.264/MJPEG
Min. Illumination	Panoramic Camera: Color: 0.002 Lux@(F1.0, AGC ON) Tracking PTZ Camera: Color: 0.0035 Lux@(F1.6, AGC ON)
WDR	120dB WDR
Lens	Panoramic Camera:6mm Tracking PTZ Camera:13mm to 52mm
FOV	Panoramic Camera:Horizontal FOV 54° Tracking PTZ Camera: Horizontal FOV 32° to 8°
Max. IR Range	40m
VCA	Multi-Target-Type Detection, Face Capture, Face Comparison
Frame Rate	50Hz: 25fps (2560 × 1440, 1920 × 1080, 1280 × 960, 1280 × 720) 60Hz: 30fps (2560 × 1440, 1920 × 1080, 1280 × 960, 1280 × 720)
Streams	3
Protection Level	IP66
Angle Adjustment	Pan: 0° to 210°, tilt: -15° to 22°
Operating Temperature	Outdoor: -40°C to 70°C (-40°F to 158°F)
Humidity	≤ 90%
Local Storage	Built-in memory card slot, support microSD/microSDHC/microSDXC (up to 256 GB)
Indoor/Outdoor	Outdoor
Audio I/O	1-ch audio input and 1-ch audio output
Alarm I/O	1-ch alarm input and 1-ch alarm output, support alarm linkage: Memory Card Recording/Alarm Output/Notify Surveillance Center/Upload to FTP/Send Email
Power	36 VDC ± 25%, two core terminal block





8 series

Model	IDS-2CD814660-IZS	IDS-2CD8A4660-IZHS	IDS-2CD8C4660-XZS(11-40/4)	IDS-2CD8C4660P-XZS(10-50/4)
Image	 DeepinView	 DeepinView	 DeepinView	 DeepinView
Image Sensor	1/1.8" Progressive Scan CMOS	1/1.8" Progressive Scan CMOS	1/1.8" Progressive Scan CMOS	1/1.8" Progressive Scan CMOS
Max. Resolution	2560 × 1440	2560 × 1440	2560 × 1440	2560 × 1440
Video Compression	Main stream: H.265+/H.265/H.264+/H.264 Sub-stream/Third stream/Fourth stream/Fifth stream/custom stream: H.265/H.264/MJPEG	Main stream: H.265+/H.265/H.264+/H.264 Sub-stream/Third stream/Fourth stream/Fifth stream/custom stream: H.265/H.264/MJPEG	Main stream: H.265+/H.265/H.264+/H.264 Sub-stream/Third stream/Fourth stream/Fifth stream/custom stream: H.265/H.264/MJPEG	Main stream: H.265+/H.265/H.264+/H.264 Sub-stream/Third stream/Fourth stream/Fifth stream/custom stream: H.265/H.264/MJPEG
Min. Illumination	Color: 0.0045 Lux @ (F1.8, AGC ON), 0 Lux with IR	Color: 0.0045 Lux @ (F1.8, AGC ON), 0 Lux with IR	Color: 0.0001 Lux @ (F1.4, AGC ON), 0 Lux with IR	Color: 0.0002 Lux @ (F1.2, AGC ON), 0 Lux with IR
WDR	140dB	140dB	120dB	120dB
Lens	8 to 32 mm	8 to 32 mm	11 to 40 mm and 4mm	10 to 50 mm and 4mm
FOV	Motorized lens, 8 to 32 mm Horizontal FOV 40° to 16°, vertical FOV 22° to 9°, diagonal FOV 46° to 18°	Motorized lens, 8 to 32 mm Horizontal FOV 38° to 15°, vertical FOV 21° to 9°, diagonal FOV 43° to 18°	Motorized lens, 11 to 40 mm Horizontal FOV 37° to 11.5°, vertical FOV 20.2° to 6.5°, diagonal FOV 43.2° to 13.2° 4mm Horizontal FOV 89°, vertical FOV 46.5°	Motorized lens, 10 to 50 mm Horizontal FOV 39.9° to 9.5°, vertical FOV 22.0° to 5.3°, diagonal FOV 46.3° to 10.9° 4mm Horizontal FOV 160°, vertical FOV 48°
Max. IR Range	Up to 30 m	Up to 100 m	80m	80m
VCA	Deep Learning-based algorithm: Face Capture, Face Recognition, Face Attributes Traditional algorithm: Motion detection, video tampering alarm, exception, Face Detection	Deep Learning-based algorithm: Face Capture, Face Recognition, Face Attributes Traditional algorithm: Motion detection, video tampering alarm, exception, Face Detection	Deep Learning-based algorithm: Face Capture, Face Recognition Traditional algorithm: Motion detection, video tampering alarm, exception, Face Detection	Deep Learning-based algorithm: Face Capture, Face Recognition, multi-target-detection, Face de-duplication Traditional algorithm: Motion detection, video tampering alarm, exception, Face Detection
Frame Rate	50Hz: 25fps (2560 × 1440, 1920 × 1080, 1280 × 720) 60Hz: 30fps (2560 × 1440, 1920 × 1080, 1280 × 720)	50Hz: 25fps (2560 × 1440, 1920 × 1080, 1280 × 720) 60Hz: 30fps (2560 × 1440, 1920 × 1080, 1280 × 720)	50Hz: 25fps (2560 × 1440, 1920 × 1080, 1280 × 720) 60Hz: 30fps (2560 × 1440, 1920 × 1080, 1280 × 720)	50Hz: 25fps (2560 × 1440, 1920 × 1080, 1280 × 720) 60Hz: 30fps (2560 × 1440, 1920 × 1080, 1280 × 720)
Streams	5+5	5+5	5	5
Protection Level	IP66	IP67	IP67	IP66
Angle Adjustment	Pan: 0° to 355°, tilt: 0° to 75°, rotate: 0° to 355°	Pan: 0° to 355°, tilt: 0° to 75°, rotate: 0° to 355°	-	-
Operating Temperature	-30 °C to 60 °C (-22 °F to 140 °F)	-30 °C to 60 °C (-22 °F to 140 °F)	-30 °C to 60 °C (-22 °F to 140 °F)	-30 °C to 60 °C (-22 °F to 140 °F)
Humidity	Humidity 95% or less (non-condensing)	Humidity 95% or less (non-condensing)	Humidity 95% or less (non-condensing)	Humidity 95% or less (non-condensing)
Local Storage	Support Micro SD/SDHC/SDXC card (256G) local storage	Support Micro SD/SDHC/SDXC card (256G) local storage	Support Micro SD/SDHC/SDXC card (256G) local storage	Support Micro SD/SDHC/SDXC card (128G) local storage, NAS INFS,SMB/CIFS), ANR
Indoor/Outdoor				
Audio I/O	1 input (line in, 3.5 mm), 1 output (line out, 3.5 mm), 1 built-in mic	1 input (line in, 3.5 mm), 1 output (line out, 3.5 mm)	2 input (line in, 3.5 mm), 1 output (line out, 3.5 mm)	1 input (line in, 3.5 mm), 1 output (line out, 3.5 mm)
Alarm I/O	1 input, 1 output (max. 24 VDC/VAC, 1A)	2 inputs, 2 outputs (max. 24 VDC, 1 A)	3 inputs, 2 outputs (max. 24 VDC or 24VDC, 1 A)	2 inputs, 2 outputs (max. 24 VDC, 1 A)
Power	12 VDC ±20%, reverse polarity protection; two-core terminal block; 24 VAC±20%; PoE (802.3at, type 2, class 4)	12 VDC ±20%, reverse polarity protection; three-core terminal block; PoE (802.3at, type 2, class 4)	24 VAC	24 VAC



Model	IDS-2CD702660-[AP]	IDS-2CD704660-[AP]/[F11]	IDS-2CD708660-AP	IDS-2CD70C560-AP	IDS-2CD712660-IZS	IDS-2CD714660-IZS
Image	 DeepinView	 DeepinView	 DeepinView	 DeepinView	 DeepinView	 DeepinView
Image Sensor	1/1.8" Progressive Scan CMOS	1/1.8" Progressive Scan CMOS	1/1.8" Progressive Scan CMOS	1/1.7" Progressive Scan CMOS	1/1.8" Progressive Scan CMOS	1/1.8" Progressive Scan CMOS
Max. Resolution	1920 × 1080	2680 × 1520	3840 × 2160	4000 × 3000	1920 × 1080	2680 × 1520
Video Compression	Main stream: H.265+/H.265/H.264+/H.264 Sub-stream/Third stream/Fourth stream/Fifth stream/custom stream:H.265/H.264/MJPEG	Main stream: H.265+/H.265/H.264+/H.264 Sub-stream/Third stream/Fourth stream/Fifth stream/custom stream:H.265/H.264/MJPEG	Main stream: H.265+/H.265/H.264+/H.264 Sub-stream/Third stream/Fourth stream/Fifth stream/custom stream:H.265/H.264/MJPEG	Main stream: H.265+/H.265/H.264+/H.264 Sub-stream/Third stream/Fourth stream/Fifth stream/custom stream:H.265/H.264/MJPEG	Main stream: H.265+/H.265/H.264+/H.264 Sub-stream/Third stream/Fourth stream/Fifth stream/custom stream:H.265/H.264/MJPEG	Main stream: H.265+/H.265/H.264+/H.264 Sub-stream/Third stream/Fourth stream/Fifth stream/custom stream:H.265/H.264/MJPEG
Min. Illumination	Color: 0.001 Lux @ (F1.2, AGC ON); B/W: 0.0003 Lux @ (F1.2, AGC ON)	Color: 0.001 Lux @ (F1.2, AGC ON); B/W: 0.0003 Lux @ (F1.2, AGC ON)	Color: 0.009 Lux @ (F1.2, AGC ON); B/W: 0.0009 Lux @ (F1.2, AGC ON)	Color: 0.009 Lux @ (F1.2, AGC ON); B/W: 0.0009 Lux @ (F1.2, AGC ON)	Color: 0.001 Lux @ (F1.2, AGC ON); B/W: 0.0003 Lux @ (F1.2, AGC ON)	Color: 0.001 Lux @ (F1.2, AGC ON); B/W: 0.0003 Lux @ (F1.2, AGC ON)
WDR	140 dB	140 dB	120 dB	DWDR	140 dB	140 dB
Lens	CS mount	CS mount	CS mount	CS mount	2.8 to 12 mm or 8 to 32 mm	2.8 to 12 mm or 8 to 32 mm
FOV	-	-	-	-	2.8 to 12 mm, horizontal FOV 107.3° to 39.8°, vertical FOV 55.9° to 22.3°, diagonal FOV 130.1° to 45.7° 8 to 32 mm, horizontal FOV 40.3° to 14.4°, vertical FOV 22.1° to 8.2°, diagonal FOV 46.9° to 16.5°	2.8 to 12 mm, horizontal FOV 114.5° to 41.8°, vertical FOV 59.3° to 23.6°, diagonal FOV 141.1° to 48° 8 to 32 mm, horizontal FOV 42.5° to 15.1°, vertical FOV 23.3° to 8.64°, diagonal FOV 49.6° to 17.3°
Max. IR Range	-	-	-	-	2.8 to 12 mm: 30 m 8 to 32 mm: 50 m	2.8 to 12 mm: 30 m 8 to 32 mm: 50 m
VCA	Deep Learning-based algorithm: Multi-target-type Detection, Face Comparison, Face Capture, Face Recognition, Face Attributes, Premier Protection, Queue Management, Face Counting, Hard Hat Detection Traditional algorithm: Motion detection, video tampering alarm, exception, Counting	Deep Learning-based algorithm: Multi-target-type Detection, Face Comparison, Face Capture, Face Recognition, Face Attributes, Premier Protection, Queue Management, Face Counting, Hard Hat Detection Traditional algorithm: Motion detection, video tampering alarm, exception, Counting	Deep Learning-based algorithm: Multi-target-type Detection, Face Comparison, Face Capture, Face Recognition, Face Attributes, Premier Protection, Queue Management, Face Counting, Hard Hat Detection Traditional algorithm: Motion detection, video tampering alarm, exception, Counting	Deep Learning-based algorithm: Multi-target-type Detection, Face Comparison, Face Capture, Face Recognition, Face Attributes, Premier Protection, Queue Management, Face Counting, Hard Hat Detection Traditional algorithm: Motion detection, video tampering alarm, exception, Counting	Deep Learning-based algorithm: Multi-target-type Detection, Face Comparison, Face Capture, Face Recognition, Face Attributes, Premier Protection, Queue Management Traditional algorithm: Motion detection, video tampering alarm, exception, Counting	Deep Learning-based algorithm: Multi-target-type Detection, Face Comparison, Face Capture, Face Recognition, Face Attributes, Premier Protection, Queue Management Traditional algorithm: Motion detection, video tampering alarm, exception, Counting
Frame Rate	50Hz: 50fps (1920 × 1080, 1280 × 720) 60Hz: 60fps (1920 × 1080, 1280 × 720)	50Hz: 25fps (2680 × 1520, 2560 × 1440, 1920 × 1080, 1280 × 720) 60Hz: 30fps (2680 × 1520, 2560 × 1440, 1920 × 1080, 1280 × 720)	50Hz: 25fps (3840 × 2160, 3200 × 1800, 2560 × 1440, 1920 × 1080, 1280 × 720) 60Hz: 30fps (3840 × 2160, 3200 × 1800, 2560 × 1440, 1920 × 1080, 1280 × 720)	50Hz: 25fps (4096 × 2160, 3840 × 2160, 3072 × 1728, 2560 × 1440, 1920 × 1080, 1280 × 720) 60Hz: 30fps (4096 × 2160, 3840 × 2160, 3072 × 1728, 2560 × 1440, 1920 × 1080, 1280 × 720) 50Hz: 20fps (4000 × 3000); 60Hz: 20fps (4000 × 3000)	50Hz: 50fps (1920 × 1080, 1280 × 720) 60Hz: 60fps (1920 × 1080, 1280 × 720)	50Hz: 25fps (2680 × 1520, 2560 × 1440, 1920 × 1080, 1280 × 720) 60Hz: 30fps (2680 × 1520, 2560 × 1440, 1920 × 1080, 1280 × 720)
Streams	5+5	5+5	5+5	5+5	5+5	5+5
Protection Level	-	-	-	-	IK10	IK10
Angle Adjustment	-	-	-	-	Pan: 0° to 355°, tilt: 0° to 75°, rotate: 0° to 355°	Pan: 0° to 355°, tilt: 0° to 75°, rotate: 0° to 355°
Operating Temperature	-30 °C to 60 °C (-22 °F to 140 °F).	-30 °C to 60 °C (-22 °F to 140 °F).	-30 °C to 60 °C (-22 °F to 140 °F).	-30 °C to 60 °C (-22 °F to 140 °F).	-30 °C to 60 °C (-22 °F to 140 °F)	-30 °C to 60 °C (-22 °F to 140 °F)
Humidity	95% or less (non-condensing)	Humidity 95% or less (non-condensing)	Humidity 95% or less (non-condensing)	Humidity 95% or less (non-condensing)	Humidity 95% or less (non-condensing)	Humidity 95% or less (non-condensing)
Local Storage	Built-in micro SD/SDHC/SDXC slot, up to 256 GB	Built-in micro SD/SDHC/SDXC slot, up to 256 GB	Built-in micro SD/SDHC/SDXC slot, up to 256 GB	Built-in micro SD/SDHC/SDXC slot, up to 256 GB	Built-in micro SD/SDHC/SDXC slot, up to 256 GB	Built-in micro SD/SDHC/SDXC slot, up to 256 GB
Indoor/Outdoor	Indoor	Indoor	Indoor	Indoor	Indoor	Indoor
Audio I/O	1 inputs (line in), 1 output (line out), 3.5 mm connector, 2 channels, 1 built-in microphone	1 inputs (line in), 1 output (line out), 3.5 mm connector, 2 channels, 1 built-in microphone	1 inputs (line in), 1 output (line out), 3.5 mm connector, 2 channels, 1 built-in microphone	1 inputs (line in), 1 output (line out), 3.5 mm connector, 2 channels, 1 built-in microphone	1 input (line in), 3.5 mm connector; 1 output (line out), 3.5 mm connector, mono sound, 1 built-in microphone	1 input (line in), 3.5 mm connector; 1 output (line out), 3.5 mm connector, 1 built-in microphone
Alarm I/O	2 inputs, 2 outputs (max. 24 VDC, 1A)	2 inputs, 2 outputs (max. 24 VDC, 1A)	2 inputs, 2 outputs (max. 24 VDC, 1A)	2 inputs, 2 outputs (max. 24 VDC, 1A)	1 input, 1 output (max. 24 VDC, 1 A)	1 input, 1 output (max. 24 VDC, 1 A)
Power	12 VDC ± 20%, two-core terminal block, reverse polarity protection; 24 VAC ± 20%; PoE: 802.3af, Type 1 Class 3	12 VDC ± 20%, two-core terminal block, reverse polarity protection; 24 VAC ± 20%; PoE: 802.3af, Type 1 Class 3	12 VDC ± 20%, two-core terminal block, reverse polarity protection; 24 VAC ± 20%; PoE: 802.3af, Type 1 Class 3	12 VDC ± 20%, two-core terminal block, reverse polarity protection; 24 VAC ± 20%; PoE: 802.3af, Type 1 Class 3	12 VDC ± 20%, two-core terminal block, reverse polarity protection; 24 VAC ± 20%; PoE: 802.3af, Type 1 Class 3	12 VDC ± 20%, two-core terminal block, reverse polarity protection; 24 VAC ± 20%; PoE: 802.3af, Type 1 Class 3

Model	IDS-2CD718660-IZS	IDS-2CD71C560-IZS	IDS-2CD752660-IZHS(Y)(R)	IDS-2CD754660-IZHS(Y)(R)	IDS-2CD758660-IZHS(Y)(R)	IDS-2CD75C560-IZHS(Y)(R)	
Image	 DeepinView	 DeepinView	 DeepinView	 DeepinView	 DeepinView	 DeepinView	
Image Sensor	1/1.8" Progressive Scan CMOS	1/1.7" Progressive Scan CMOS	1/1.8" Progressive Scan CMOS	1/1.8" Progressive Scan CMOS	1/1.8" Progressive Scan CMOS	1/1.7" Progressive Scan CMOS	
Max. Resolution	3840 × 2160	4000 × 3000	1920 × 1080	2680 × 1520	3840 × 2160	4000 × 3000	
Video Compression	Main stream: H.265+/H.265/H.264+/ H.264 Sub-stream/Third stream/Fourth stream/Fifth stream/custom stream: H.265/H.264/MJPEG	Main stream: H.265+/H.265/H.264+/ H.264 Sub-stream/Third stream/Fourth stream/Fifth stream/custom stream: H.265/H.264/MJPEG	Main stream: H.265+/H.265/H.264+/ H.264 Sub-stream/Third stream/Fourth stream/Fifth stream/custom stream: H.265/H.264/MJPEG	Main stream: H.265+/H.265/H.264+/ H.264 Sub-stream/Third stream/Fourth stream/Fifth stream/custom stream: H.265/H.264/MJPEG	Main stream: H.265+/H.265/H.264+/ H.264 Sub-stream/Third stream/Fourth stream/Fifth stream/custom stream: H.265/H.264/MJPEG	Main stream: H.265+/H.265/H.264+/ H.264 Sub-stream/Third stream/Fourth stream/Fifth stream/custom stream: H.265/H.264/MJPEG	
Min. Illumination	Color: 0.009 Lux @ (F1.2, AGC ON); B/W: 0.0009 Lux @ (F1.2, AGC ON)	Color: 0.009 Lux @ (F1.2, AGC ON); B/W: 0.0009 Lux @ (F1.2, AGC ON)	Color: 0.001 Lux @ (F1.2, AGC ON); B/W: 0.0003 Lux @ (F1.2, AGC ON)	Color: 0.001 Lux @ (F1.2, AGC ON); B/W: 0.0003 Lux @ (F1.2, AGC ON)	Color: 0.009 Lux @ (F1.2, AGC ON); B/W: 0.0009 Lux @ (F1.2, AGC ON)	Color: 0.009 Lux @ (F1.2, AGC ON); B/W: 0.0009 Lux @ (F1.2, AGC ON)	
WDR	120 dB	DWDR	140 dB	140 dB	120 dB	DWDR	
Lens	2.8 to 12 mm or 8 to 32 mm	2.8 to 12 mm or 8 to 32 mm	2.8 to 12 mm or 8 to 32 mm	2.8 to 12 mm or 8 to 32 mm	2.8 to 12 mm or 8 to 32 mm	2.8 to 12 mm or 8 to 32 mm	
FOV	2.8 to 12 mm, horizontal FOV 112.3° to 41.2°, vertical FOV 58° to 23.1°, diagonal FOV 137.3° to 47.3° 8 to 32 mm, horizontal FOV 41.8° to 14.9°, vertical FOV 22.92° to 8.48°, diagonal FOV 48.7° to 17°	2.8 to 12 mm, horizontal FOV 96° to 46.2°, vertical FOV 69.2° to 27.2°, diagonal FOV 131° to 45.2° 8 to 32 mm, horizontal FOV 37.8° to 13.6°, vertical FOV 27.8° to 10.3°, diagonal FOV 48.6° to 17.4°	2.8 to 12 mm, horizontal FOV 107.3° to 39.8°, vertical FOV 55.9° to 22.3°, diagonal FOV 130.1° to 45.7° 8-32mm, horizontal FOV 40.3° to 14.4°, vertical FOV 22.1° to 8.2°, diagonal FOV 46.9° to 16.5°	2.8 to 12 mm, horizontal FOV 114.5° to 41.8°, vertical FOV 59.3° to 23.6°, diagonal FOV 141.1° to 48° 8 to 32mm, horizontal FOV 42.5° to 15.1°, vertical FOV 23.3° to 8.64°, diagonal FOV 49.6° to 17.3°	2.8 to 12 mm, horizontal FOV 112.3° to 41.2°, vertical FOV 58° to 23.1°, diagonal FOV 137.3° to 47.3° 8 to 32 mm, horizontal FOV 41.8° to 14.9°, vertical FOV 22.9° to 8.5°, diagonal FOV 48.7° to 17°	2.8 to 12 mm, horizontal FOV 96° to 46.2°, vertical FOV 69.2° to 27.2°, diagonal FOV 131° to 45.2° 8 to 32 mm, horizontal FOV 37.8° to 13.6°, vertical FOV 27.8° to 10.3°, diagonal FOV 48.6° to 17.4°	2.8 to 12 mm, horizontal FOV 96° to 46.2°, vertical FOV 69.2° to 27.2°, diagonal FOV 131° to 45.2° 8 to 32 mm, horizontal FOV 37.8° to 13.6°, vertical FOV 27.8° to 10.3°, diagonal FOV 48.6° to 17.4°
Max. IR Range	2.8 to 12 mm: 30 m 8 to 32 mm: 50 m	2.8 to 12 mm: 30 m 8 to 32 mm: 50 m	2.8 to 12 mm: 30 m 8 to 32 mm: 50 m	2.8 to 12 mm: 30 m 8 to 32 mm: 50 m	2.8 to 12 mm: 30 m 8 to 32 mm: 50 m	2.8 to 12 mm: 30 m 8 to 32 mm: 50 m	
VCA	Deep Learning-based algorithm: Multi-target-type Detection, Face Comparison, Face Capture, Face Recognition, Face Attributes, Premier Protection, Queue Management Traditional algorithm: Motion detection, video tampering alarm, exception, Counting	Deep Learning-based algorithm: Multi-target-type Detection, Face Comparison, Face Capture, Face Recognition, Face Attributes, Premier Protection, Queue Management Traditional algorithm: Motion detection, video tampering alarm, exception, Counting	Deep Learning-based algorithm: Multi-target-type Detection, Face Comparison, Face Capture, Face Recognition, Face Attributes, Premier Protection, Queue Management Traditional algorithm: Motion detection, video tampering alarm, exception, Counting	Deep Learning-based algorithm: Multi-target-type Detection, Face Comparison, Face Capture, Face Recognition, Face Attributes, Premier Protection, Queue Management Traditional algorithm: Motion detection, video tampering alarm, exception, Counting	Deep Learning-based algorithm: Multi-target-type Detection, Face Comparison, Face Capture, Face Recognition, Face Attributes, Premier Protection, Queue Management Traditional algorithm: Motion detection, video tampering alarm, exception, Counting	Deep Learning-based algorithm: Multi-target-type Detection, Face Comparison, Face Capture, Face Recognition, Face Attributes, Premier Protection, Queue Management Traditional algorithm: Motion detection, video tampering alarm, exception, Counting	
Frame Rate	50Hz: 25fps (3840 × 2160, 3200 × 1800, 2560 × 1440, 1920 × 1080, 1280 × 720) 60Hz: 30fps (3840 × 2160, 3200 × 1800, 2560 × 1440, 1920 × 1080, 1280 × 720)	50Hz: 25fps (4096 × 2160, 3840 × 2160, 3072 × 1728, 2560 × 1440, 1920 × 1080, 1280 × 720) 60Hz: 30fps (4096 × 2160, 3840 × 2160, 3072 × 1728, 2560 × 1440, 1920 × 1080, 1280 × 720) 50Hz: 20fps (4000 × 3000) 60Hz: 20fps (4000 × 3000)	50 Hz: 50 fps (1920 × 1080, 1280 × 720) 60 Hz: 60 fps (1920 × 1080, 1280 × 720)	50 Hz: 25 fps (2680 × 1520, 2560 × 1440, 1920 × 1080, 1280 × 720) 60 Hz: 30 fps (2680 × 1520, 2560 × 1440, 1920 × 1080, 1280 × 720)	50 Hz: 25 fps (3840 × 2160, 3200 × 1800, 2560 × 1440, 1920 × 1080, 1280 × 720) 60 Hz: 30 fps (3840 × 2160, 3200 × 1800, 2560 × 1440, 1920 × 1080, 1280 × 720)	50 Hz: 25 fps (4096 × 2160, 3840 × 2160, 3072 × 1728, 2560 × 1440, 1920 × 1080, 1280 × 720) 60 Hz: 30 fps (4096 × 2160, 3840 × 2160, 3072 × 1728, 2560 × 1440, 1920 × 1080, 1280 × 720) 50 Hz: 20 fps (4000 × 3000) 60 Hz: 20 fps (4000 × 3000)	
Streams	5+5	5+5	5+5	5+5	5+5	5+5	
Protection Level	IK10	IK10	IP67,IK10	IP67,IK10	IP67,IK10	IP67,IK10	
Angle Adjustment	Pan: 0° to 355°, tilt: 0° to 75°, rotate: 0° to 355°	Pan: 0° to 355°, tilt: 0° to 75°, rotate: 0° to 355°	Pan: 0° to 355°, tilt: 0° to 75°, rotate: 0° to 355°	Pan: 0° to 355°, tilt: 0° to 75°, rotate: 0° to 355°	Pan: 0° to 355°, tilt: 0° to 75°, rotate: 0° to 355°	Pan: 0° to 355°, tilt: 0° to 75°, rotate: 0° to 355°	
Operating Temperature	-30 °C to 60 °C [-22 °F to 140 °F]	-30 °C to 60 °C [-22 °F to 140 °F]	-40 °C to 60 °C [-22 °F to 140 °F]	-40 °C to 60 °C [-22 °F to 140 °F]	-40 °C to 60 °C [-22 °F to 140 °F]	-40 °C to 60 °C [-22 °F to 140 °F]	
Humidity	Humidity 95% or less (non-condensing)	Humidity 95% or less (non-condensing)	Humidity 95% or less (non-condensing)	Humidity 95% or less (non-condensing)	Humidity 95% or less (non-condensing)	Humidity 95% or less (non-condensing)	
Local Storage	Built-in micro SD/SDHC/SDXC slot, up to 256 GB	Built-in micro SD/SDHC/SDXC slot, up to 256 GB	Built-in micro SD/SDHC/SDXC slot, up to 256 GB	Built-in micro SD/SDHC/SDXC slot, up to 256 GB	Built-in micro SD/SDHC/SDXC slot, up to 256 GB	Built-in micro SD/SDHC/SDXC slot, up to 256 GB	
Indoor/Outdoor	Indoor	Indoor	Outdoor	Outdoor	Outdoor	Outdoor	
Audio I/O	1 input (line in), 3.5 mm connector,; 1 output (line out), 3.5 mm connector, mono sound, 1 built-in microphone	1 input (line in), 3.5 mm connector,; 1 output (line out), 3.5 mm connector, mono sound, 1 built-in microphone	With -R: 2 built-in microphone Without -R: 1 input (line in), 3.5 mm connector, 1 output (line out), 3.5 mm connector, mono sound	With -R: 2 built-in microphone Without -R: 1 input (line in), 3.5 mm connector, 1 output (line out), 3.5 mm connector, mono sound	With -R: 2 built-in microphone Without -R: 1 input (line in), 3.5 mm connector, 1 output (line out), 3.5 mm connector, mono sound	With -R: 2 built-in microphone Without -R: 1 input (line in), 3.5 mm connector, 1 output (line out), 3.5 mm connector, mono sound	
Alarm I/O	1 input, 1 output (max. 24 VDC, 1 A)	1 input, 1 output (max. 24 VDC, 1 A)	1 input, 1 output (max. 24 VDC, 1 A)	1 input, 1 output (max. 24 VDC, 1 A)	1 input, 1 output (max. 24 VDC, 1 A)	1 input, 1 output (max. 24 VDC, 1 A)	
Power	12 VDC ± 20%, two-core terminal block, reverse polarity protection; 24 VAC ± 20%; PoE: 802.3af, Type 1 Class 3	12 VDC ± 20%, two-core terminal block, reverse polarity protection; 24 VAC ± 20%; PoE: 802.3af, Type 1 Class 3	12 VDC ± 20%, 10 to 48 VDC, two-core terminal block, reverse polarity protection; 24 VAC ± 20%, 15 to 36 VDC; PoE: 802.3at, Type 1, Class 4	12 VDC ± 20%, 10 to 48 VDC, two-core terminal block, reverse polarity protection; 24 VAC ± 20%, 15 to 36 VDC; PoE: 802.3at, Type 1, Class 4	12 VDC ± 20%, 10 to 48 VDC, two-core terminal block, reverse polarity protection; 24 VAC ± 20%, 15 to 36 VDC; PoE: 802.3at, Type 1, Class 4	12 VDC ± 20%, 10 to 48 VDC, two-core terminal block, reverse polarity protection; 24 VAC ± 20%, 15 to 36 VDC; PoE: 802.3at, Type 1, Class 4	12 VDC ± 20%, 10 to 48 VDC, two-core terminal block, reverse polarity protection; 24 VAC ± 20%, 15 to 36 VDC; PoE: 802.3at, Type 1, Class 4

Model	IDS-2CD7A2660-IZHS(Y)(R)	IDS-2CD7A4660-IZHS(Y)(R)	IDS-2CD7A8660-IZHS(Y)(R)	IDS-2CD7AC560-IZHS(Y)(R)	IDS-2CD702660/E-IHSY(R)	IDS-2CD704660/E-IHSY(F11)(R)	
Image	 DeepinView	 DeepinView	 DeepinView	 DeepinView	 DeepinView	 DeepinView	
Image Sensor	1/1.8" Progressive Scan CMOS	1/1.8" Progressive Scan CMOS	1/1.8" Progressive Scan CMOS	1/1.7" Progressive Scan CMOS	1/1.8" Progressive Scan CMOS	1/1.8" Progressive Scan CMOS	
Max. Resolution	1920 × 1080	2680 × 1520	3840 × 2160	4000 × 3000	1920 × 1080	2680 × 1520	
Video Compression	Main stream: H.265+/H.265/H.264+ / H.264 Sub-stream/Third stream/Fourth stream/Fifth stream/custom stream: H.265/H.264/MJPEG	Main stream: H.265+/H.265/H.264+ / H.264 Sub-stream/Third stream/Fourth stream/Fifth stream/custom stream: H.265/H.264/MJPEG	Main stream: H.265+/H.265/H.264+ / H.264 Sub-stream/Third stream/Fourth stream/Fifth stream/custom stream: H.265/H.264/MJPEG	Main stream: H.265+/H.265/H.264+ / H.264 Sub-stream/Third stream/Fourth stream/Fifth stream/custom stream: H.265/H.264/MJPEG	Main stream: H.265+/H.265/H.264+ / H.264 Sub-stream/Third stream/Fourth stream/Fifth stream/custom stream: H.265/H.264/MJPEG	Main stream: H.265+/H.265/H.264+ / H.264 Sub-stream/Third stream/Fourth stream/Fifth stream/custom stream: H.265/H.264/MJPEG	
Min. Illumination	Color: 0.001 Lux @ (F1.2, AGC ON); B/W: 0.0003 Lux @ (F1.2, AGC ON)	Color: 0.001 Lux @ (F1.2, AGC ON); B/W: 0.0003 Lux @ (F1.2, AGC ON)	Color: 0.009 Lux @ (F1.2, AGC ON); B/W: 0.0009 Lux @ (F1.2, AGC ON)	Color: 0.009 Lux @ (F1.2, AGC ON); B/W: 0.0009 Lux @ (F1.2, AGC ON)	Color: 0.002 Lux @ (F1.4, AGC ON); B/W: 0.0002 Lux @ (F1.4, AGC ON)	Color: 0.002 Lux @ (F1.4, AGC ON); B/W: 0.0002 Lux @ (F1.4, AGC ON)	
WDR	140 dB	140 dB	120 dB	DWDR	140 dB	140 dB	
Lens	2.8 to 12 mm or 8 to 32 mm	2.8 to 12 mm or 8 to 32 mm	2.8 to 12 mm or 8 to 32 mm	2.8 to 12 mm or 8 to 32 mm	CS mount	CS mount	
FOV	2.8 to 12 mm, horizontal FOV: 107.3° to 39.8°, vertical FOV: 55.9° to 22.3°, diagonal FOV: 130.1° to 45.7° 8 to 32 mm, horizontal FOV: 40.3° to 14.4°, vertical FOV: 22.1° to 8.2°, diagonal FOV: 46.9° to 16.5°	2.8 to 12 mm, horizontal FOV: 114.5° to 41.8°, vertical FOV: 59.3° to 23.6°, diagonal FOV: 141.1° to 48° 8 to 32 mm, horizontal FOV: 42.5° to 15.1°, vertical FOV: 23.3° to 8.64°, diagonal FOV: 49.6° to 17.3°	2.8 to 12 mm, horizontal FOV: 112.3° to 41.2°, vertical FOV: 58° to 23.1°, diagonal FOV: 137.3° to 47.3° 8 to 32 mm, horizontal FOV: 41.8° to 14.9°, vertical FOV: 22.92° to 8.48°, diagonal FOV: 48.7° to 17°	2.8 to 12 mm, horizontal FOV: 96.2° to 36.4°, vertical FOV: 69.3° to 27.2°, diagonal FOV: 129.4° to 45.5° 8 to 32 mm, horizontal FOV: 40.2° to 14.4°, vertical FOV: 29.6° to 10.8°, diagonal FOV: 51.47° to 17.8°	3.8 to 16 mm, horizontal FOV: 109.1° to 29.6°, vertical FOV: 61.3° to 16.8°, diagonal FOV: 125.1° to 33.9° 11 to 40 mm, horizontal FOV: 39.1° to 12.1°, vertical FOV: 21.4° to 6.8°, diagonal FOV: 45.8° to 13.9°	3.8 to 16 mm, horizontal FOV: 109.1° to 29.6°, vertical FOV: 61.3° to 16.8°, diagonal FOV: 125.1° to 33.9° 11 to 40 mm, horizontal FOV: 39.1° to 12.1°, vertical FOV: 21.4° to 6.8°, diagonal FOV: 45.8° to 13.9°	3.8 to 16 mm, horizontal FOV: 109.1° to 29.6°, vertical FOV: 61.3° to 16.8°, diagonal FOV: 125.1° to 33.9° 11 to 40 mm, horizontal FOV: 39.1° to 12.1°, vertical FOV: 21.4° to 6.8°, diagonal FOV: 45.8° to 13.9°
Max. IR Range	2.8 to 12 mm: 50 m 8 to 32 mm: 80 m	2.8 to 12 mm: 50 m 8 to 32 mm: 80 m	2.8 to 12 mm: 50 m 8 to 32 mm: 80 m	2.8 to 12 mm: 50 m 8 to 32 mm: 80 m	3.8 to 12 mm: 80 m 11 to 40 mm: 120 m	3.8 to 16 mm: 80 m 11 to 40 mm: 120 m	
VCA	Deep Learning-based algorithm: Multi-target-type Detection, Face Comparison, Face Capture, Face Recognition, Face Attributes, Premier Protection, Queue Management Traditional algorithm: Motion detection, video tampering alarm, exception, Counting	Deep Learning-based algorithm: Multi-target-type Detection, Face Comparison, Face Capture, Face Recognition, Face Attributes, Premier Protection, Queue Management Traditional algorithm: Motion detection, video tampering alarm, exception, Counting	Deep Learning-based algorithm: Multi-target-type Detection, Face Comparison, Face Capture, Face Recognition, Face Attributes, Premier Protection, Queue Management Traditional algorithm: Motion detection, video tampering alarm, exception, Counting	Deep Learning-based algorithm: Multi-target-type Detection, Face Comparison, Face Capture, Face Recognition, Face Attributes, Premier Protection, Queue Management Traditional algorithm: Motion detection, video tampering alarm, exception, Counting	Deep Learning-based algorithm: Multi-target-type Detection, Face Comparison, Face Capture, Face Recognition, Face Attributes, Premier Protection, Queue Management Traditional algorithm: Motion detection, video tampering alarm, exception, Counting	Deep Learning-based algorithm: Multi-target-type Detection, Face Comparison, Face Capture, Face Recognition, Face Attributes, Premier Protection, Queue Management Traditional algorithm: Motion detection, video tampering alarm, exception, Counting	
Frame Rate	50Hz: 50fps (1920 × 1080, 1280 × 720) 60Hz: 60fps (1920 × 1080, 1280 × 720)	50Hz: 25fps (2680 × 1520, 2560 × 1440, 1920 × 1080, 1280 × 720) 60Hz: 30fps (2680 × 1520, 2560 × 1440, 1920 × 1080, 1280 × 720)	50Hz: 25 fps (3840 × 2160, 3200 × 1800, 2560 × 1440, 1920 × 1080, 1280 × 720) 60Hz: 30 fps (3840 × 2160, 3200 × 1800, 2560 × 1440, 1920 × 1080, 1280 × 720)	50Hz: 25fps (4096 × 2160, 3840 × 2160, 3072 × 1728, 2560 × 1440, 1920 × 1080, 1280 × 720) 60Hz: 30fps (4096 × 2160, 3840 × 2160, 3072 × 1728, 2560 × 1440, 1920 × 1080, 1280 × 720) 50Hz: 20fps (4000 × 3000) 60Hz: 20fps (4000 × 3000)	50 Hz: 50 fps (1920 × 1080, 1280 × 720) 60 Hz: 60 fps (1920 × 1080, 1280 × 720)	50 Hz: 25 fps (2680 × 1520, 2560 × 1440, 1920 × 1080, 1280 × 720) 60 Hz: 30 fps (2680 × 1520, 2560 × 1440, 1920 × 1080, 1280 × 720)	
Streams	5+5	5+5	5+5	5+5	5+5	5+5	
Protection Level	IP67, IK10	IP67, IK10	IP67, IK10	IP67, IK10	IP66, IK10	IP66, IK10	
Angle Adjustment	Bracket, pan: 0° to 355°, tilt: 0° to 90°, rotate: 0° to 360°	Bracket, pan: 0° to 355°, tilt: 0° to 90°, rotate: 0° to 360°	Bracket, pan: 0° to 355°, tilt: 0° to 90°, rotate: 0° to 360°	Bracket, pan: 0° to 355°, tilt: 0° to 90°, rotate: 0° to 360°	-	-	
Operating Temperature	-40 °C to 60 °C [-22 °F to 140 °F]	-40 °C to 60 °C [-22 °F to 140 °F]	-40 °C to 60 °C [-22 °F to 140 °F]	-40 °C to 60 °C [-22 °F to 140 °F]	-40 °C to 65 °C [-40 °F to 149 °F]	-40 °C to 65 °C [-40 °F to 149 °F]	
Humidity	Humidity 95% or less (non-condensing)	Humidity 95% or less (non-condensing)	Humidity 95% or less (non-condensing)	Humidity 95% or less (non-condensing)	95% or less (non-condensing)	Humidity 95% or less (non-condensing)	
Local Storage	Built-in micro SD/SDHC/SDXC slot, up to 256 GB	Built-in micro SD/SDHC/SDXC slot, up to 256 GB	Built-in micro SD/SDHC/SDXC slot, up to 256 GB	Built-in micro SD/SDHC/SDXC slot, up to 256 GB	Built-in micro SD/SDHC/SDXC slot, up to 256 GB	Built-in micro SD/SDHC/SDXC slot, up to 256 GB	
Indoor/Outdoor	Outdoor	Outdoor	Outdoor	Outdoor	Outdoor	Outdoor	
Audio I/O	With -R: not support with -IZHSY 1 input (line in), 3.5 mm connector, 1 output (line out), 3.5 mm connector, mono sound	With -R: not support with -IZHSY 1 input (line in), 3.5 mm connector, 1 output (line out), 3.5 mm connector, mono sound	With -R: not support with -IZHSY 1 input (line in), 3.5 mm connector, 1 output (line out), 3.5 mm connector, mono sound	With -R: not support with -IZHSY 1 input (line in), 3.5 mm connector, 1 output (line out), 3.5 mm connector, mono sound	With -R: not support Without -R: 1 input (line in), 1 output (line out), 3.5 mm connector, 2 channels	With -R: not support Without -R: 1 input (line in), 1 output (line out), 3.5 mm connector, 2 channels	
Alarm I/O	2 input, 2 outputs (max. 24 VDC, 1 A)	2 input, 2 outputs (max. 24 VDC, 1 A)	2 input, 2 outputs (max. 24 VDC, 1 A)	2 input, 2 outputs (max. 24 VDC, 1 A)	2 inputs, 2 outputs (max. 24 VDC, 1 A)	2 inputs, 2 outputs (max. 24 VDC, 1 A)	
Power	12 VDC ± 20%, three-core terminal block, reverse polarity protection; PoE: 802.3at, Type 2 Class 4	12 VDC ± 20%, three-core terminal block, reverse polarity protection; PoE: 802.3at, Type 2 Class 4	12 VDC ± 20%, three-core terminal block, reverse polarity protection; PoE: 802.3at, Type 2 Class 4	12 VDC ± 20%, three-core terminal block, reverse polarity protection; PoE: 802.3at, Type 2 Class 4	12 VDC ± 20%, two-core terminal block, reverse polarity protection; 24 VAC ± 20%; PoE: 802.3bt, Type3, Class 5	12 VDC ± 20%, two-core terminal block, reverse polarity protection; 24 VAC ± 20%; PoE: 802.3bt, Type3, Class 5	

Model	IDS-2CD708660/E-IHSY(R)	IDS-2CD70C560/E-IHSY(R)	IDS-2CD7A2660/P-IZHS(Y)	IDS-2CD7A4660/P-IZHS(Y)
Image	 DeepinView NEW	 DeepinView NEW	 DeepinView NEW ANPR	 DeepinView NEW HOT NEW
Image Sensor	1/1.8" Progressive Scan CMOS	1/1.8" Progressive Scan CMOS	1/1.8" Progressive Scan CMOS	1/1.8" Progressive Scan CMOS
Max. Resolution	3840 × 2160	4000 × 3000	1920 × 1080	2680 × 1520
Video Compression	Main stream: H.265+/H.265/H.264+/H.264 Sub-stream/Third stream/Fourth stream/Fifth stream/ custom stream:H.265/H.264/MJPEG	Main stream: H.265+/H.265/H.264+/H.264 Sub-stream/Third stream/Fourth stream/Fifth stream/ custom stream:H.265/H.264/MJPEG	Main stream: H.265+/H.265/H.264+/H.264 Sub-stream/Third stream/Fourth stream/Fifth stream/ custom stream:H.265/H.264/MJPEG	Main stream: H.265+/H.265/H.264+/H.264 Sub-stream/Third stream/Fourth stream/Fifth stream/ custom stream:H.265/H.264/MJPEG
Min. Illumination	Color: 0.002 Lux @ (F1.4, AGC ON); B/W: 0.0002 Lux @ (F1.4, AGC ON)	Color: 0.002 Lux @ (F1.4, AGC ON); B/W: 0.0002 Lux @ (F1.4, AGC ON)	Color: 0.001 Lux @ (F1.2, AGC ON); B/W: 0.0003 Lux @ (F1.2, AGC ON)	Color: 0.001 Lux @ (F1.2, AGC ON); B/W: 0.0003 Lux @ (F1.2, AGC ON)
WDR	120 dB	DWDR	140 dB	140 dB
Lens	CS mount	CS mount	2.8 to 12 mm or 8 to 32 mm	2.8 to 12 mm or 8 to 32 mm
FOV	3.8 to 16 mm, horizontal FOV: 107.4° to 29.1°, vertical FOV: 60.0° to 16.5°, diagonal FOV: 123.1° to 33.4° 11 to 40 mm, horizontal FOV: 38.4° to 11.9°, vertical FOV: 20.9° to 6.7°, diagonal FOV: 44.9° to 13.7°	3.8 to 16 mm, horizontal FOV: 103.5° to 28.1°, vertical FOV: 77.3° to 21.1°, diagonal FOV: 129.3° to 35.0° 11 to 40 mm, horizontal FOV: 36.9° to 11.5°, vertical FOV: 27.1° to 8.6°, diagonal FOV: 47.5° to 14.4°	2.8 to 12 mm, horizontal FOV: 107.3° to 39.8°, vertical FOV: 55.9° to 22.3°, diagonal FOV: 130.1° to 45.7° 8 to 32 mm, horizontal FOV: 40.3° to 14.4°, vertical FOV: 22.1° to 8.2° diagonal FOV: 46.9° to 16.5°	2.8 to 12 mm, horizontal FOV: 114.5° to 41.8°, vertical FOV: 59.3° to 23.6°, diagonal FOV: 141.1° to 48° 8 to 32 mm, horizontal FOV: 42.5° to 15.1°, vertical FOV: 23.3° to 8.64°, diagonal FOV: 49.6° to 17.3°
Max. IR Range	3.8 to 16 mm: 80 m 11 to 40 mm: 120 m	3.8 to 16 mm: 80 m 11 to 40 mm: 120 m	2.8-12mm:50m 8-32mm:100m	2.8-12mm:50m 8-32mm:100m
VCA	Deep Learning-based algorithm: Multi-target-type Detection, Face Comparison, Face Capture, Face Recognition, Face Attributes, Premier Protection, Queue Management Traditional algorithm: Motion detection, video tampering alarm, exception, Counting	Deep Learning-based algorithm: Multi-target-type Detection, Face Comparison, Face Capture, Face Recognition, Face Attributes, Premier Protection, Queue Management Traditional algorithm: Motion detection, video tampering alarm, exception, Counting	Deep Learning-based algorithm: Premier Protection, Road Traffic and Vehicle Detection Traditional algorithm: Motion detection, video tampering alarm, exception	Deep Learning-based algorithm: Premier Protection, Road Traffic and Vehicle Detection Traditional algorithm: Motion detection, video tampering alarm, exception
Frame Rate	50Hz: 25fps (3840 × 2160, 3200 × 1800, 2560 × 1440, 1920 × 1080, 1280 × 720) 60Hz: 30fps (3840 × 2160, 3200 × 1800, 2560 × 1440, 1920 × 1080, 1280 × 720)	50 Hz: 25 fps (4096 × 2160, 3840 × 2160, 3072 × 1728, 2560 × 1440, 1920 × 1080, 1280 × 720) 60 Hz: 30 fps (4096 × 2160, 3840 × 2160, 3072 × 1728, 2560 × 1440, 1920 × 1080, 1280 × 720) 50 Hz: 20 fps (4000 × 3000) 60 Hz: 20 fps (4000 × 3000)	50Hz: 50fps (1920 × 1080, 1280 × 720) 60Hz: 60fps (1920 × 1080, 1280 × 720)	50Hz: 25fps (2680 × 1520, 2560 × 1440, 1920 × 1080, 1280 × 720) 60Hz: 30fps (2680 × 1520, 2560 × 1440, 1920 × 1080, 1280 × 720)
Streams	5+5	5+5	5+5	5+5
Protection Level	IP66, IK10	IP66, IK10	IP67, IK10	IP67, IK10
Angle Adjustment	-	-	Bracket, pan: 0° to 355°, tilt: 0° to 90°, rotate: 0° to 360°	Bracket, pan: 0° to 355°, tilt: 0° to 90°, rotate: 0° to 360°
Operating Temperature	-40 °C to 65 °C (-40 °F to 149 °F)	-40 °C to 65 °C (-40 °F to 149 °F)	-40 °C to 60 °C (-22 °F to 140 °F)	-40 °C to 60 °C (-22 °F to 140 °F)
Humidity	Humidity 95% or less (non-condensing)	Humidity 95% or less (non-condensing)	Humidity 95% or less (non-condensing)	Humidity 95% or less (non-condensing)
Local Storage	Built-in micro SD/SDHC/SDXC slot, up to 256 GB	Built-in micro SD/SDHC/SDXC slot, up to 256 GB	Built-in micro SD/SDHC/SDXC slot, up to 256 GB	Built-in micro SD/SDHC/SDXC slot, up to 256 GB
Indoor/Outdoor	Outdoor	Outdoor	Outdoor	
Audio I/O	With -R: not support Without -R: 1 input (line in), 1 output (line out), 3.5 mm connector, 2 channels	With -R: not support Without -R: 1 input (line in), 1 output (line out), 3.5 mm connector, 2 channels	Without -Y: not support with -Y 1 input (line in), 3.5 mm connector, 1 output (line out), 3.5 mm connector, mono sound	Without -Y: not support with -Y 1 input (line in), 3.5 mm connector, 1 output (line out), 3.5 mm connector, mono sound
Alarm I/O	2 inputs, 2 outputs (max. 24 VDC, 1A)	2 inputs, 2 outputs (max. 24 VDC, 1A)	2 input, 2 outputs (max. 24 VDC, 1 A)	2 input, 2 outputs (max. 24 VDC, 1 A)
Power	12 VDC ± 20%, two-core terminal block, reverse polarity protection; 24 VAC ± 20%; PoE: 802.3bt, Type3, Class 5	12 VDC ± 20%, two-core terminal block, reverse polarity protection; 24 VAC ± 20%; PoE: 802.3bt, Type3, Class 5	12 VDC ± 20%, three-core terminal block, reverse polarity protection; PoE: 802.3at, Type 2 Class 4	12 VDC ± 20%, three-core terminal block, reverse polarity protection; PoE: 802.3at, Type 2 Class 4

Model	IDS-2CD702660/EP-IHSY	IDS-2CD704660/EP-IHSY
Image	 NEW ANPR DeepinView	 NEW ANPR DeepinView
Image Sensor	1/1.8" Progressive Scan CMOS	1/1.8" Progressive Scan CMOS
Max. Resolution	1920 × 1080	2688 × 1520
Video Compression	Main stream: H.265+/H.265/H.264+/H.264 Sub-stream/third stream/fourth stream/fifth stream/custom stream: H.265/H.264/MJPEG	Main stream: H.265+/H.265/H.264+/H.264Sub-stream/Third stream/Fourth stream/Fifth stream/custom stream:H.265/H.264/MJPEG
Min. Illumination	Color: 0.002 Lux @ (F1.4, AGC ON); B/W: 0.002 Lux @ (F1.4, AGC ON)	Color: 0.002 Lux @ (F1.4, AGC ON); B/W: 0.002 Lux @ (F1.4, AGC ON)
WDR	140 dB	140 dB
Lens	CS mount	CS mount
FOV	3.8 to 16 mm, horizontal FOV: 109.1° to 29.6°, vertical FOV: 61.3° to 16.8°, diagonal FOV: 125.1° to 33.9° 11 to 40 mm, horizontal FOV: 39.1° to 12.1°, vertical FOV: 21.4° to 6.8°, diagonal FOV: 45.8° to 13.9°	3.8 to 16 mm, horizontal FOV: 109.1° to 29.6°, vertical FOV: 61.3° to 16.8°, diagonal FOV: 125.1° to 33.9° 11 to 40 mm, horizontal FOV: 39.1° to 12.1°, vertical FOV: 21.4° to 6.8°, diagonal FOV: 45.8° to 13.9°
Max. IR Range	3.8 to 16 mm: 80 m 11 to 40 mm: 120 m	3.8 to 16 mm: 80 m 11 to 40 mm: 120 m
VCA	Deep Learning-based algorithm: Premier Protection, Road Traffic and Vehicle Detection Traditional algorithm: Motion detection, video tampering alarm, exception	Deep Learning-based algorithm: Premier Protection, Road Traffic and Vehicle Detection Traditional algorithm: Motion detection, video tampering alarm, exception
Frame Rate	50Hz: 50fps (1920 × 1080, 1280 × 720) 60Hz: 60fps (1920 × 1080, 1280 × 720)	50Hz: 25fps (2688 × 1520, 2560 × 1440, 1920 × 1080, 1280 × 720) 60Hz: 30fps (2688 × 1520, 2560 × 1440, 1920 × 1080, 1280 × 720)
Streams	5+5	5+5
Protection Level	IP66, IK10	IP66, IK10
Angle Adjustment	-	-
Operating Temperature	-40 °C to 65 °C (-40 °F to 149 °F)	-40 °C to 65 °C (-40 °F to 149 °F)
Humidity	Humidity 95% or less (non-condensing)	Humidity 95% or less (non-condensing)
Local Storage	Built-in micro SD/SDHC/SDXC slot, up to 256 GB	Built-in micro SD/SDHC/SDXC slot, up to 256 GB
Indoor/Outdoor	Outdoor	Outdoor
Audio I/O	1 inputs (line in), 1 output (line out), 3.5 mm connector, 2 channels,	1 input (line in), 1 output (line out), 3.5 mm connector, 2 channels,
Alarm I/O	2 inputs, 2 outputs (max. 24 VDC, 1A)	2 inputs, 2 outputs (max. 24 VDC, 1 A)
Power	12 VDC ± 20%, two-core terminal block, reverse polarity protection; 24 VAC ± 20%; PoE: 802.3bt, Type3 Class 5	12 VDC ± 20%, two-core terminal block, reverse polarity protection; 24 VAC ± 20%; PoE: 802.3bt, Type3, Class 5



Model	DS-2CD682560/C-IS	DS-2CD682560/C-IVS
Image	 HOT DeepinView	 HOT DeepinView
Image Sensor	1/1.2.7" Progressive Scan CMOS	1/1.2.7" Progressive Scan CMOS
Max. Resolution	1920 × 1080	1920 × 1080
Video Compression	Main stream: H.265+/H.265/H.264+/H.264 Sub stream: H.265/H.264/MJPEG	Main stream: H.265+/H.265/H.264+/H.264 Sub stream: H.265/H.264/MJPEG
Min. Illumination	Color: 0.0176 Lux @ (F2.25, AGC ON) B/W: 0.0035 Lux @ (F2.2.5, AGC ON)	Color: 0.0176 Lux @ (F2.25, AGC ON) B/W: 0.0035 Lux @ (F2.2.5, AGC ON)
WDR	Digital WDR	Digital WDR
Lens	2 mm	2 mm
FOV	Horizontal FOV 104.5°, vertical FOV 70.5°, diagonal FOV 112°	Horizontal FOV 104.5°, vertical FOV 70.5°, diagonal FOV 112°
Max. IR Range	6 m	6 m
VCA	Counts people entering and exiting separately Supports real-time uploading and uploading by statistic cycle Sends email reports on daily, weekly, monthly or annually basis Supports target filtering by height	Counts people entering and exiting separately Supports real-time uploading and uploading by statistic cycle Sends email reports on daily, weekly, monthly or annually basis Supports target filtering by height
Frame Rate	50Hz: 25fps (1920 × 1080, 1280 × 720); 60Hz: 30fps (1920 × 1080, 1280 × 720)	50Hz: 25fps (1920 × 1080, 1280 × 720); 60Hz: 30fps (1920 × 1080, 1280 × 720)
Streams	2	2
Protection Level	-	IP67
Angle Adjustment	-	-
Operating Temperature	-30 °C to +45 °C (-22 °F to +113 °F)	-30 °C to +45 °C (-22 °F to +113 °F)
Humidity	95% or less (non-condensing)	95% or less (non-condensing)
Local Storage	-	-
Indoor/Outdoor	Indoor	Outdoor
Audio I/O	1 built-in mic -S: 1 input (line in, two-core terminal block), 1 output (two-core terminal block), mono sound	1 built-in mic -S: 1 input (line in, two-core terminal block), 1 output (two-core terminal block), mono sound
Alarm I/O	1 input, 1 output (max. 24 VDC, 1 A)	1 input, 1 output (max. 24 VDC, 1 A)
Power	12 VDC±20%, reverse polarity protection, Ø5.5mm coaxial power plug 12 VDC, PoE (36 to 57 VDC, 802.3af), Calss3	12 VDC±20%, reverse polarity protection, Ø5.5mm coaxial power plug 12 VDC, PoE (36 to 57 VDC, 802.3af), Calss3

Ultra Series Network Cameras

- › Ultra Series Cameras easily meet the requirements for projects with surprisingly high performance, excellent stability and network security
- › Excellent adaptability to lighting conditions with DarkFighter and ColorVu technologies
- › False alarm reduction through human and vehicle target classification based on AcuSense technology
- › Excellent stability: dual-file system backup, wide voltage range, NEMA 4X anti-corrosion, etc.
- › Loaded with advanced security functionalities to increase your system's cyber defense capabilities, including 802.1x EAP-TLS 1.2, security audit log, stream encryption, SFTP, SD card encryption, etc.
- › Supports HEOP, Metadata, ONVIF, ISAPI, SDK, and E-Home to make integration easier



Model	DS-2CD502660-(AP)	DS-2CD504660-(AP)	DS-2CD508560-(AP)	DS-2CD50C560-(AP)
Image	 DarkFighter ⁺	 DarkFighter ⁺		
Image Sensor	1/1.8" Progressive Scan CMOS	1/1.8" Progressive Scan CMOS	1/1.8" Progressive Scan CMOS	1/1.7" Progressive Scan CMOS
Max. Resolution	1920 × 1080	2560 × 1440	3840 × 2160	4000 × 3000
Video Compression	H.265 / H.265+ / H.264+ / H.264 / MJPEG	H.265 / H.265+ / H.264+ / H.264 / MJPEG	H.265 / H.265+ / H.264+ / H.264 / MJPEG	H.265 / H.265+ / H.264+ / H.264 / MJPEG
Min. Illumination	Color: 0.002 Lux @ (F1.2, AGC ON); B/W: 0.0002 Lux @ (F1.2, AGC ON)	Color: 0.002 Lux @ (F1.2, AGC ON); B/W: 0.0002 Lux @ (F1.2, AGC ON)	Color: 0.007 Lux @ (F1.2, AGC ON); B/W: 0.0007 Lux @ (F1.2, AGC ON)	Color: 0.008 Lux @ (F1.2, AGC ON); B/W: 0.0008 Lux @ (F1.2, AGC ON); 0 Lux with IR
WDR	140 dB	140 dB	120 dB	DWDR
Lens	-	-	-	-
FOV	-	-	-	-
Max. IR Range	-	-	-	-
VCA	Line crossing detection, intrusion detection, region entrance detection, region exiting detection, unattended baggage detection, object removal detection	Line crossing detection, intrusion detection, region entrance detection, region exiting detection, unattended baggage detection, object removal detection	Line crossing detection, intrusion detection, region entrance detection, region exiting detection, unattended baggage detection, object removal detection	Line crossing detection, intrusion detection, region entrance detection, region exiting detection, unattended baggage detection, object removal detection
Frame Rate	50Hz: 50fps (1920×1080, 1280×960, 1280×720) 60Hz: 60fps (1920×1080, 1280×960, 1280×720)	50Hz: 25fps (2560 × 1440, 1920 × 1080, 1280 × 720) 60Hz: 30fps (2560 × 1440, 1920 × 1080, 1280 × 720)	50Hz: 25fps (3840×2160, 3200×1800, 2560×1440, 1920×1080, 1280×720) 60Hz: 30fps (3840×2160, 3200×1800, 2560×1440, 1920×1080, 1280×720)	50Hz: 20fps(4000 × 3000), 25fps (4096 × 2160, 3840 × 2160, 3072 × 1728, 2560 × 1440, 1920 × 1080, 1280 × 720) 60Hz: 20fps(4000 × 3000), 30fps (4096 × 2160, 3840 × 2160, 3072 × 1728, 2560 × 1440, 1920 × 1080, 1280 × 720)
Multi-Streaming	5+5	5+5	5+5	5+5
Protection Level	-	-	-	-
Angle Adjustment	-	-	-	-
Operating Temperature	-30 °C to 60 °C (-22 °F to 140 °F)	-30 °C to 60 °C (-22 °F to 140 °F)	-30 °C to 60 °C (-22 °F to 140 °F)	-30 °C to 60 °C (-22 °F to 140 °F)
Operating Humidity	humidity 95% or less (non-condensing)	humidity 95% or less (non-condensing)	Humidity 95% or less (non-condensing)	Humidity 95% or less (non-condensing)
Local Storage	Built-in micro SD/SDHC/SDXC slot, up to 256 GB	Built-in micro SD/SDHC/SDXC slot, up to 256 GB	Built-in micro SD/SDHC/SDXC slot, up to 256 GB	Built-in micro SD/SDHC/SDXC slot, up to 256 GB
Audio I/O	1 input (line in), 1 output (line out), mono	1 input (line in), 1 output (line out), mono	1 input (line in), 1 output (line out), mono	1 input (line in), 1 output (line out), mono
Alarm I/O	2 inputs, 2 outputs	2 inputs, 2 outputs	2 inputs, 2 outputs	2 inputs, 2 outputs
Installation	-	-	-	-
Power Supply	12 VDC is recommended, 10 to 48 VDC; 24 VAC (-25%, +24.9%); two-core terminal block; PoE (802.3af, class 3); Reverse polarity protection	12 VDC is recommended, 10 to 48 VDC; 24 VAC (-25%, +24.9%); two-core terminal block; PoE (802.3af, class 3); Reverse polarity protection	12 VDC is recommended, 10 to 48 VDC; 24 VAC (-25%, +24.9%); two-core terminal block; PoE (802.3af, class 3); Reverse polarity protection	12 VDC is recommended, 10 to 48 VDC; 24 VAC (-25%, +24.9%); two-core terminal block; PoE (802.3af, class 3); Reverse polarity protection

Model	DS-2CD512660-IZS	DS-2CD514660-IZS	DS-2CD518560-IZS	DS-2CD51C560-IZS
Image	 	 		
Image Sensor	1/1.8" Progressive Scan CMOS	1/1.8" Progressive Scan CMOS	1/1.8" Progressive Scan CMOS	1/1.7" Progressive Scan CMOS
Max. Resolution	1920×1080	2560 × 1440	3840×2160	4000×3000
Video Compression	H.265 / H.265+ / H.264+ / H.264 / MJPEG	H.265 / H.265+ / H.264+ / H.264 / MJPEG	H.265 / H.265+ / H.264+ / H.264 / MJPEG	H.265 / H.265+ / H.264+ / H.264 / MJPEG
Min. Illumination	Color: 0.002 Lux @ (F1.2, AGC ON), 0 Lux with IR	Color: 0.002 Lux @ (F1.2, AGC ON), 0 Lux with IR	Color: 0.007 Lux @ (F1.2, AGC ON), 0 Lux with IR	Color: 0.008 Lux @ (F1.2, AGC ON), 0 Lux with IR
WDR	140 dB	140 dB	120 dB	DWDR
Lens	2.8 to 12 mm	2.8 to 12 mm	2.8 to 12 mm	2.8 to 12 mm
FOV	horizontal FOV 103.3° to 38.6°, vertical FOV 54.2° to 21.9°, diagonal FOV 124.2° to 44.3°	horizontal FOV 109.2° to 38.9°, vertical FOV 56.2° to 21.9°, diagonal FOV 134.5° to 45°	horizontal FOV 112.4° to 41°, vertical FOV 58° to 23°, diagonal FOV 137° to 47°	horizontal FOV 101° to 36.1°, vertical FOV 72° to 27.2°, diagonal FOV 130° to 45.2°
Max. IR Range	30 m	30 m	30 m	30 m
VCA	Line crossing detection, intrusion detection, region entrance detection, region exiting detection, unattended baggage detection, object removal detection	Line crossing detection, intrusion detection, region entrance detection, region exiting detection, unattended baggage detection, object removal detection	Line crossing detection, intrusion detection, region entrance detection, region exiting detection, unattended baggage detection, object removal detection	Line crossing detection, intrusion detection, region entrance detection, region exiting detection, unattended baggage detection, object removal detection
Frame Rate	50Hz: 50fps (1920×1080, 1280×960, 1280×720) 60Hz: 60fps (1920×1080, 1280×960, 1280×720)	50Hz: 25fps (2560 × 1440, 1920 × 1080, 1280 × 720) 60Hz: 30fps (2560 × 1440, 1920 × 1080, 1280 × 720)	50Hz: 25fps (3840×2160, 3200×1800, 2560×1440, 1920×1080, 1080×720) 60Hz: 30fps (3840×2160, 3200×1800, 2560×1440, 1920×1080, 1080×720)	50Hz: 20fps(4000 × 3000), 25fps (4096 × 2160, 3840 × 2160, 3072 × 1728, 2560 × 1440, 1920 × 1080, 1280 × 720) 60Hz: 20fps(4000 × 3000), 30fps (4096 × 2160, 3840 × 2160, 3072 × 1728, 2560 × 1440, 1920 × 1080, 1280 × 720)
Multi-Streaming	5+5	5+5	5+5	5+5
Protection Level	IK10	IK10	IK10	IK10
Angle Adjustment	Pan: 0° to 355°, tilt: 0° to 75°, rotate: 0° to 355°	Pan: 0° to 355°, tilt: 0° to 75°, rotate: 0° to 355°	Pan: 0° to 355°, tilt: 0° to 75°, rotate: 0° to 355°	Pan: 0° to 355°, tilt: 0° to 75°, rotate: 0° to 355°
Operating Temperature	-30 °C to 60 °C (-22 °F to 140 °F)	-30 °C to 60 °C (-22 °F to 140 °F)	-30 °C to 60 °C (-22 °F to 140 °F)	-30 °C to 60 °C (-22 °F to 140 °F)
Operating Humidity	humidity 95% or less (non-condensing)	humidity 95% or less (non-condensing)	humidity 95% or less (non-condensing)	humidity 95% or less (non-condensing)
Local Storage	Built-in micro SD/SDHC/SDXC slot, up to 256 GB	Built-in micro SD/SDHC/SDXC slot, up to 256 GB	Built-in micro SD/SDHC/SDXC slot, up to 256 GB	Built-in micro SD/SDHC/SDXC slot, up to 256 GB
Audio I/O	1 input (line in, 3.5 mm), 1 output (line out, 3.5 mm), mono sound	1 input (line in, 3.5 mm), 1 output (line out, 3.5 mm), mono sound	1 input (line in, 3.5 mm), 1 output (line out, 3.5 mm), mono sound	1 input (line in, 3.5 mm), 1 output (line out, 3.5 mm), mono sound
Alarm I/O	1 input, 1 output	1 input, 1 output	1 input, 1 output	1 input, 1 output
Installation	-	-	-	-
Power Supply	12 VDC is recommended, 10 to 48 VDC; reverse polarity protection; two-core terminal block; PoE (802.3af, class 3)	12 VDC is recommended, 10 to 48 VDC; reverse polarity protection; two-core terminal block; PoE (802.3af, class 3)	12 VDC is recommended, 10 to 48 VDC; reverse polarity protection; two-core terminal block; PoE (802.3af, class 3)	12 VDC is recommended, 10 to 48 VDC; reverse polarity protection; two-core terminal block; PoE (802.3af, class 3)

Model	DS-2CD5A2660-IZ(H)S	DS-2CD5A2660-IZ(H)SY	DS-2CD5A4660-IZ(H)S	DS-2CD5A4660-IZ(H)SY	DS-2CD5A8560-IZ(H)S	DS-2CD5AC560-IZ(H)S
Image	 DarkFighter	 DarkFighter	 DarkFighter	 DarkFighter		
Image Sensor	1/1.8" Progressive Scan CMOS	1/1.8" Progressive Scan CMOS	1/1.8" Progressive Scan CMOS	1/1.8" Progressive Scan CMOS	1/1.8" Progressive Scan CMOS	1/1.7" Progressive Scan CMOS
Max. Resolution	1920×1080	1920×1080	2560 × 1440	2560 × 1440	3840 × 2160	4000×3000
Video Compression	H.265 / H.265+ / H.264+ / H.264 / MJPEG	H.265 / H.265+ / H.264+ / H.264 / MJPEG	H.265 / H.265+ / H.264+ / H.264 / MJPEG	H.265 / H.265+ / H.264+ / H.264 / MJPEG	H.265 / H.265+ / H.264+ / H.264 / MJPEG	H.265 / H.265+ / H.264+ / H.264 / MJPEG
Min. Illumination	Color: 0.004 Lux @ (F1.6, AGC ON), 0 Lux with IR	Color: 0.002 Lux @ (F1.2, AGC ON), 0 Lux with IR	Color: 0.005 Lux @ (F1.8, AGC ON), 0 Lux with IR on	Color: 0.002 Lux @ (F1.2, AGC ON), 0 Lux with IR on	Color: 0.016 Lux @ (F1.8, AGC ON), 0 Lux with IR on	Color: 0.018 Lux @ (F1.8, AGC ON), 0 Lux with IR on
WDR	140 dB	140 dB	140 dB	140 dB	120 dB	DWDR
Lens	2.8 to 12 mm, 8 to 32 mm	2.8 to 12 mm	2.8 to 12 mm, 8 to 32mm	2.8 to 12 mm	2.8 to 12 mm, 8 to 32 mm	2.8 to 12 mm
FOV	2.8 to 12 mm, horizontal FOV 103.3° to 38.6°, vertical FOV 54.2° to 21.9°, diagonal FOV 124.2° to 44.3° 8 to 32 mm, horizontal FOV 42.5° to 13.4°, vertical FOV 23.4° to 7.7°, diagonal FOV 49° to 15.3°	2.8 to 12 mm, horizontal FOV 103.3° to 38.6°, vertical FOV 54.2° to 21.9°, diagonal FOV 124.2° to 44.3°	2.8 to 12 mm, horizontal FOV 109.2° to 38.9°, vertical FOV 56.2° to 21.9°, diagonal FOV 134.5° to 45° 8 to 32 mm, horizontal FOV 37.7° to 15.2°, vertical FOV 21° to 8.6°, diagonal FOV 43.3° to 17.24°	2.8 to 12 mm, horizontal FOV 109.2° to 38.9°, vertical FOV 56.2° to 21.9°, diagonal FOV 134.5° to 45°	2.8 to 12 mm, horizontal FOV 112.4° to 41°, vertical FOV 58° to 23°, diagonal FOV 137° to 47° 8 to 32 mm, horizontal FOV 39° to 15.6°, vertical FOV 21.8° to 8.9°, diagonal FOV 45° to 17.8°	2.8 to 12 mm, horizontal FOV 101° to 36.1°, vertical FOV 72° to 27.2°, diagonal FOV 130° to 45.2°
Max. IR Range	2.8 to 12 mm lens: 50 m 8 to 32 mm lens: 100 m	50 m	2.8-12 mm lens: 50 m 8-32 mm lens: 100 m	50 m	2.8-12 mm lens: 50 m 8-32 mm lens: 100 m	50 m
VCA	Line crossing detection, intrusion detection, region entrance detection, region exiting detection, unattended baggage detection, object removal detection	Line crossing detection, intrusion detection, region entrance detection, region exiting detection, unattended baggage detection, object removal detection	Line crossing detection, intrusion detection, region entrance detection, region exiting detection, unattended baggage detection, object removal detection	Line crossing detection, intrusion detection, region entrance detection, region exiting detection, unattended baggage detection, object removal detection	Line crossing detection, intrusion detection, region entrance detection, region exiting detection, unattended baggage detection, object removal detection	Line crossing detection, intrusion detection, region entrance detection, region exiting detection, unattended baggage detection, object removal detection
Frame Rate	50Hz: 50fps (1920×1080, 1280×960, 1280×720) 60Hz: 60fps (1920×1080, 1280×960, 1280×720)	50Hz: 25fps (1920 × 1080, 1280 × 960, 1280 × 720), 50fps (1920 × 1080, 1280 × 960, 1280 × 720) 60Hz: 30fps (1920 × 1080, 1280 × 960, 1280 × 720), 60fps (1920 × 1080, 1280 × 960, 1280 × 720)	50Hz: 25fps (2560 × 1440, 1920 × 1080, 1280 × 720) 60Hz: 30fps (2560 × 1440, 1920 × 1080, 1280 × 720)	50Hz: 25fps (2560 × 1440, 1920 × 1080, 1280 × 720) 60Hz: 30fps (2560 × 1440, 1920 × 1080, 1280 × 720)	50Hz: 25fps (3840×2160, 3200×1800, 2560×1440, 1920×1080, 1280×720) 60Hz: 30fps (3840×2160, 3200×1800, 2560×1440, 1920×1080, 1280×720)	50Hz: 20fps(4000 × 3000), 25fps (4096 × 2160, 3840 × 2160, 3072 × 1728, 2560 × 1440, 1920 × 1080, 1280 × 720) 60Hz: 20fps(4000 × 3000), 30fps (4096 × 2160, 3840 × 2160, 3072 × 1728, 2560 × 1440, 1920 × 1080, 1280 × 720)
Multi-Streaming	5+5	5+5	5+5	5+5	5+5	5+5
Protection Level	IP67, IK10	IP67, IK10, Anti-Corrosion Standard: NEMA 4X	IP67, IK10	IP67, IK10, Anti-Corrosion Standard: NEMA 4X	IP67, IK10	IP67, IK10
Angle Adjustment	Bracket, pan: 0° to 355°, tilt: 0° to 90°, rotate: 0° to 360°	Bracket, pan: 0° to 355°, tilt: 0° to 75°, rotate: 0° to 360°	Bracket, pan: 0° to 355°, tilt: 0° to 90°, rotate: 0° to 360°	Bracket, pan: 0° to 355°, tilt: 0° to 90°, rotate: 0° to 360°	Bracket, pan: 0° to 355°, tilt: 0° to 90°, rotate: 0° to 360°	Bracket, pan: 0° to 355°, tilt: 0° to 90°, rotate: 0° to 360°
Operating Temperature	-30 °C to 65°C (-22 °F to 149 °F), -H: -40 °C to 65 °C (-40 °F to 149 °F)	-30 °C to 65°C (-22 °F to 149 °F), -H: -40 °C to 65 °C (-40 °F to 149 °F)	-30 °C to 65°C (-22 °F to 149 °F), -H: -40 °C to 65 °C (-40 °F to 149 °F)	-30 °C to 65°C (-22 °F to 149 °F), -H: -40 °C to 65 °C (-40 °F to 149 °F)	-30 °C to 65°C (-22 °F to 149 °F), -H: -40 °C to 65 °C (-40 °F to 149 °F)	-30 °C to 65°C (-22 °F to 149 °F), -H: -40 °C to 65 °C (-40 °F to 149 °F)
Operating Humidity	Humidity 95% or less (non-condensing)	Humidity 95% or less (non-condensing)	Humidity 95% or less (non-condensing)	Humidity 95% or less (non-condensing)	Humidity 95% or less (non-condensing)	Humidity 95% or less (non-condensing)
Local Storage	Built-in micro SD/SDHC/SDXC slot, up to 256 GB	Built-in micro SD/SDHC/SDXC slot, up to 256 GB	Built-in micro SD/SDHC/SDXC slot, up to 256 GB	Built-in micro SD/SDHC/SDXC slot, up to 256 GB	Built-in micro SD/SDHC/SDXC slot, up to 256 GB	Built-in micro SD/SDHC/SDXC slot, up to 256 GB
Audio I/O	-	-	-	-	-	-
Alarm I/O	2 inputs, 2 outputs	2 inputs, 2 outputs	2 inputs, 2 outputs	2 inputs, 2 outputs	2 inputs, 2 outputs	2 inputs, 2 outputs
Installation	-	-	-	-	-	-
Power Supply	12 VDC ± 20%, two-core terminal block; reverse polarity protection, PoE (802.3at, class 4)	12 VDC ± 20%, three-core terminal block; reverse polarity protection, PoE (802.3at, type 2, class 4)	12 VDC ± 20%, two-core terminal block; reverse polarity protection, PoE (802.3at, class 4)	12 VDC ± 20%, three-core terminal block; reverse polarity protection, PoE (802.3at, type 2, class 4)	12 VDC ± 20%, two-core terminal block; reverse polarity protection, PoE (802.3at, class 4)	12 VDC ± 20%, two-core terminal block; reverse polarity protection, PoE (802.3at, class 4)

Model	DS-2CD552660-IZ(H)S	DS-2CD552660-IZ(H)SY	DS-2CD554660-IZ(H)S	DS-2CD554660-IZ(H)SY	DS-2CD558560-IZ(H)S	DS-2CD55C560-IZ(H)S	
Image	 DarkFighter	 DarkFighter	 DarkFighter HOT	 DarkFighter HOT			
Image Sensor	1/1.8" Progressive Scan CMOS	1/1.8" Progressive Scan CMOS	1/1.8" Progressive Scan CMOS	1/1.8" Progressive Scan CMOS	1/1.8" Progressive Scan CMOS	1/1.7" Progressive Scan CMOS	
Max. Resolution	1920×1080	1920×1080	2560 × 1440	2560 × 1440	3840 × 2160	4000 × 3000	
Video Compression	H.265 / H.265+ / H.264+ / H.264 / MJPEG	H.265 / H.265+ / H.264+ / H.264 / MJPEG	H.265 / H.265+ / H.264+ / H.264 / MJPEG	H.265 / H.265+ / H.264+ / H.264 / MJPEG	H.265 / H.265+ / H.264+ / H.264 / MJPEG	H.265 / H.265+ / H.264+ / H.264 / MJPEG	
Min. Illumination	Color: 0.004 Lux @ (F1.6, AGC ON), 0 Lux with IR	Color: 0.002 Lux @ (F1.2, AGC ON), 0 Lux with IR	Color: 0.005 Lux @ (F1.8, AGC ON), 0 Lux with IR	Color: 0.002 Lux @ (F1.2, AGC ON), 0 Lux with IR	Color: 0.016 Lux @ (F1.8, AGC ON), 0 Lux with IR	Color: 0.008 Lux @ (F1.2, AGC ON), 0 Lux with IR	
WDR	140 dB	140 dB	140 dB	140 dB	120 dB	DWDR	
Lens	2.8 to 12 mm, 8 to 32 mm	2.8 to 12 mm	2.8 to 12 mm, 8 to 32 mm	2.8 to 12 mm	2.8 to 12 mm, 8 to 32 mm	2.8 to 12 mm	
FOV	2.8 to 12 mm, horizontal FOV 103.3° to 38.6°, vertical FOV 54.2° to 21.9°, diagonal FOV 124.2° to 44.3° 8 to 32 mm, horizontal FOV 42.5° to 13.4°, vertical FOV 23.4° to 7.7°, diagonal FOV 49° to 15.3°	2.8 to 12 mm, horizontal FOV 103.3° to 38.6°, vertical FOV 54.2° to 21.9°, diagonal FOV 124.2° to 44.3°	2.8 to 12 mm, horizontal FOV 109.2° to 38.9°, vertical FOV 56.2° to 21.9°, diagonal FOV 134.5° to 45° 8 to 32 mm, horizontal FOV 37.7° to 15.2°, vertical FOV 21° to 8.6°, diagonal FOV 43.4° to 17.24°	2.8 to 12 mm, horizontal FOV 109.2° to 38.9°, vertical FOV 56.2° to 21.9°, diagonal FOV 134.5° to 45°	2.8 to 12 mm, horizontal FOV 112.4° to 41°, vertical FOV 58° to 23°, diagonal FOV 137° to 47° 8 to 32 mm, horizontal FOV 39° to 15.6°, vertical FOV 21.8° to 8.9°, diagonal FOV 45° to 17.8°	2.8 to 12 mm, horizontal FOV 101° to 36.1°, vertical FOV 72° to 27.2°, diagonal FOV 130° to 45.2°	
Max. IR Range	2.8 to 12 mm lens: 30 m 8 to 32 mm lens: 50 m	30 m	2.8-12 mm lens: 30 m 8-32 mm lens: 50 m	30 m	2.8-12 mm lens: 30 m 8-32 mm lens: 50 m	30 m	
VCA	Line crossing detection, intrusion detection, region entrance detection, region exiting detection, unattended baggage detection, object removal detection	Line crossing detection, intrusion detection, region entrance detection, region exiting detection, unattended baggage detection, object removal detection	Line crossing detection, intrusion detection, region entrance detection, region exiting detection, unattended baggage detection, object removal detection	Line crossing detection, intrusion detection, region entrance detection, region exiting detection, unattended baggage detection, object removal detection	Line crossing detection, intrusion detection, region entrance detection, region exiting detection, unattended baggage detection, object removal detection	Line crossing detection, intrusion detection, region entrance detection, region exiting detection, unattended baggage detection, object removal detection	
Frame Rate	50Hz: 50fps (1920×1080, 1280×960, 1280×720) 60Hz: 60fps (1920×1080, 1280×960, 1280×720)	50Hz: 50fps (1920 × 1080, 1280 × 960, 1280 × 720) 60Hz: 60fps (1920 × 1080, 1280 × 960, 1280 × 720)	50Hz: 25fps (2560 × 1440, 1920 × 1080, 1280 × 720) 60Hz: 30fps (2560 × 1440, 1920 × 1080, 1280 × 720)	50Hz: 25fps (2560 × 1440, 1920 × 1080, 1280 × 720) 60Hz: 30fps (2560 × 1440, 1920 × 1080, 1280 × 720)	50Hz: 25fps (3840×2160, 3200×1080, 2560×1440, 1920×1080, 1080×720) 60Hz: 30fps (3840×2160, 3200×1080, 2560×1440, 1920×1080, 1080×720)	50Hz: 20fps(4000 × 3000), 25fps (4096 × 2160, 3840 × 2160, 3072 × 1728, 2560 × 1440, 1920 × 1080, 1280 × 720) 60Hz: 20fps(4000 × 3000), 30fps (4096 × 2160, 3840 × 2160, 3072 × 1728, 2560 × 1440, 1920 × 1080, 1280 × 720)	
Multi-Streaming	5+5	5+5	5+5	5+5	5+5	5+5	
Protection Level	IP67, IK10	IP67, IK10 Anti-Corrosion Standard: NEMA 4X	IP67, IK10	IP67, IK10 Anti-Corrosion Standard: NEMA 4X	IP67, IK10	IP67, IK10	
Angle Adjustment	Pan: 0° to 355°, tilt: 0° to 75°, rotate: 0° to 355°	Pan: 0° to 355°, tilt: 0° to 75°, rotate: 0° to 355°	Pan: 0° to 355°, tilt: 0° to 75°, rotate: 0° to 355°	Pan: 0° to 355°, tilt: 0° to 75°, rotate: 0° to 355°	Pan: 0° to 355°, tilt: 0° to 75°, rotate: 0° to 355°	Pan: 0° to 355°, tilt: 0° to 75°, rotate: 0° to 355°	
Operating Temperature	-30 °C to 65°C (-22 °F to 149 °F), -H: -40 °C to 65 °C (-40 °F to 149 °F)	-30 °C to 65°C (-22 °F to 149 °F), -H: -40 °C to 65 °C (-40 °F to 149 °F)	-30 °C to 65°C (-22 °F to 149 °F), -H: -40 °C to 65 °C (-40 °F to 149 °F)	-30 °C to 65°C (-22 °F to 149 °F), -H: -40 °C to 65 °C (-40 °F to 149 °F)	-30 °C to 65°C (-22 °F to 149 °F), -H: -40 °C to 65 °C (-40 °F to 149 °F)	-30 °C to 65°C (-22 °F to 149 °F), -H: -40 °C to 65 °C (-40 °F to 149 °F)	
Operating Humidity	humidity 95% or less (non-condensing)	humidity 95% or less (non-condensing)	humidity 95% or less (non-condensing)	humidity 95% or less (non-condensing)	humidity 95% or less (non-condensing)	humidity 95% or less (non-condensing)	
Local Storage	Built-in micro SD/SDHC/SDXC slot, up to 256 GB	Built-in micro SD/SDHC/SDXC slot, up to 256 GB	Built-in micro SD/SDHC/SDXC slot, up to 256 GB	Built-in micro SD/SDHC/SDXC slot, up to 256 GB	Built-in micro SD/SDHC/SDXC slot, up to 256 GB	Built-in micro SD/SDHC/SDXC slot, up to 256 GB	
Audio I/O	1-ch 3.5 mm input (line in), 1-ch 3.5 mm output (line out), mono	1-ch 3.5 mm input (line in), 1-ch 3.5mm output, mono	1-ch 3.5 mm input (line in), 1-ch 3.5mm output, mono	1-ch 3.5 mm input (line in), 1-ch 3.5mm output, mono	1-ch 3.5 mm input (line in), 1-ch 3.5mm output, mono	1-ch 3.5 mm input (line in), 1-ch 3.5mm output, mono	
Alarm I/O	1 input, 1 output	1 input, 1 output	1 input, 1 output	1 input, 1 output	1 input, 1 output	1 input, 1 output	
Installation	-	-	-	-	-	-	
Power Supply	12 VDC is recommended, 10 to 48 VDC; reverse polarity protection; two-core terminal block; PoE (802.3at, class 4)	12 VDC is recommended, 10 to 48 VDC; reverse polarity protection; two-core terminal block; PoE (802.3at, class 4)	12 VDC is recommended, 10 to 48 VDC; reverse polarity protection; two-core terminal block; PoE (802.3at, class 4)	12 VDC is recommended, 10 to 48 VDC; reverse polarity protection; two-core terminal block; PoE (802.3at, class 4)	12 VDC is recommended, 10 to 48 VDC; reverse polarity protection; two-core terminal block; PoE (802.3at, class 4)	12 VDC is recommended, 10 to 48 VDC; reverse polarity protection; two-core terminal block; PoE (802.3at, class 4)	12 VDC is recommended, 10 to 48 VDC; reverse polarity protection; two-core terminal block; PoE (802.3at, class 4)

Model	DS-2CD4A4560-IZ(H)S	DS-2CD4B2560-IZS	DS-2CD4C26FWD-(A)(P)	DS-2CD4C36FWD-(A)(P)
Image				
Image Sensor	1/2.5" progressive scan CMOS	1/2.8" Progressive Scan CMOS	1/1.8" Progressive Scan CMOS	1/2.8" Progressive Scan CMOS
Max. Resolution	2560 × 1440	1920 × 1080	1920 × 1080	2048 × 1536
Video Compression	H.265+ / H.265 / H.264+ / H.264 / MJPEG	H.265+ / H.265 / H.264+ / H.264 / MJPEG	H.265+ / H.265 / H.264+ / H.264 / MJPEG	H.265+ / H.265 / H.264+ / H.264 / MJPEG
Min. Illumination	Color: 0.007 Lux @(F1.2, AGC ON), 0.01 Lux @(F1.4, AGC ON)	0.005 Lux @(F1.2, AGC ON), 0.007 Lux @(F1.4, AGC ON)	Color: 0.002 Lux @(F1.2, AGC ON) B/W: 0.0002 Lux @(F1.2, AGC ON), 0 Lux with IR	Color: 0.005 Lux @(F1.2, AGC ON) B/W: 0.0005 Lux @(F1.2, AGC ON), 0 Lux with IR
WDR	105 dB	120 dB	120 dB	120 dB
Lens	4.7 to 94 mm	4.7 to 65.8 mm	-	-
FOV	Horizontal FOV 58.248° - 2.896° Vertical FOV 33.602° - 1.644° Diagonal FOV 65.868° - 3.31°	4.7 to 65.8 mm @F1.4, horizontal FOV 54.84° to 3.12°, vertical FOV 31.62° to 1.76°, diagonal FOV 62.08° to 3.58°	-	-
Max. IR Range	150 m	120 m	-	-
VCA	Line crossing detection, intrusion detection, region entrance detection, region exiting detection, unattended baggage detection, object removal detection	Line crossing detection, intrusion detection, region entrance detection, region exiting detection, unattended baggage detection, object removal detection	Line crossing detection, intrusion detection, region entrance detection, region exiting detection, unattended baggage detection, object removal detection	Line crossing detection, intrusion detection, region entrance detection, region exiting detection, unattended baggage detection, object removal detection
Frame Rate	50Hz: 25fps (2560 × 1440, 2304 × 1296, 1920 × 1080, 1280 × 960, 1280 × 720) 60Hz: 30fps (2560 × 1440, 2304 × 1296, 1920 × 1080, 1280 × 960, 1280 × 720)	"50Hz: 25fps (1920 × 1080, 1280 × 960, 1280 × 720) 60Hz: 30fps (1920 × 1080, 1280 × 960, 1280 × 720)"	50Hz: 25fps (1920 × 1080, 1280 × 960, 1280 × 720) 60Hz: 30fps (1920 × 1080, 1280 × 960, 1280 × 720)	50Hz: 25fps (2048 × 1536, 1920 × 1080, 1280 × 960, 1280 × 720) 60Hz: 30fps (2048 × 1536, 1920 × 1080, 1280 × 960, 1280 × 720)
Multi-Streaming	€3.00	€3.00	€3.00	€3.00
Protection Level	IP67	IP67	-	-
Angle Adjustment	Pan: 0° to 360°, tilt: 0° to 90°, rotate: 0° to 360°	Pan: 0° to 360°, tilt: 0° to 90°, rotate: 0° to 360°	-	-
Operating Temperature	-IZS: -30 °C to 60 °C (-22 °F to 140 °F) -IZ(H)S: -40 °C to 60 °C (-40 °F to 140 °F)	-30 °C to 60 °C (-22 °F to 140 °F)	-30 °C - 60 °C (-22 °F - 140 °F)	-30 °C - 60 °C (-22 °F - 140 °F)
Operating Humidity	humidity 95% or less (non-condensing)	humidity 95% or less (non-condensing)	humidity 95% or less (non-condensing)	humidity 95% or less (non-condensing)
Local Storage	Built-in Micro SD/SDHC/SDXC slot, up to 128 GB	Support Micro SD/SDHC/SDXC card (128G)	Built-in Micro SD/SDHC/SDXC slot, up to 128 GB	Built-in Micro SD/SDHC/SDXC slot, up to 128 GB
Audio I/O	1 input (line in/mic in), 1 output (line out), mono	1 input (line in), 1 output (line out), mono	1-ch 3.5mm audio input(line in/mic in), 1-ch 3.5mm audio output 1 build-in microphone(can be turned off)	1-ch 3.5mm audio input(line in/mic in), 1-ch 3.5mm audio output 1 build-in microphone(can be turned off)
Alarm I/O	1 input, 1 output	1 input, 1 output	1 input, 1 output	1 input, 1 output
Power Supply	12 VDC ± 20%, PoE (802.3at, class 4), three-core terminal blocks	12 VDC ± 20%, PoE (802.3at, class 4), three-core terminal blocks	12 VDC ± 25%, 24 VDC ± 25%, PoE (802.3af, class 3) Terminal block	12 VDC ± 25%, 24 VDC ± 25%, PoE (802.3af, class 3) Terminal block

Model	DS-2CD3T23G1-I/4G	DS-2CD3B26G2T-IZHS(Y)	DS-2CD3B46G2T-IZHS(Y)	DS-2CD3B86G2T-IZHS(Y)	DS-2CD3D26G2T-IZHS(Y)	DS-2CD3D46G2T-IZHS(Y)
Image	 4G	 DarkFighter	 DarkFighter	 DarkFighter	 DarkFighter	 DarkFighter
Image Sensor	1/2.8" Progressive Scan CMOS	1/1.8" Progressive Scan CMOS	1/1.8" Progressive Scan CMOS	1/1.8" Progressive Scan CMOS	1/1.8" Progressive Scan CMOS	1/1.8" Progressive Scan CMOS
Max. Resolution	1920 × 1080	1920 × 1080	2688 × 1520	3840 × 2160	1920 × 1080	2688 × 1520
Video Compression	H.265 / H.264 / MJPEG / H.264+ / H.265+	H.265 / H.264 / MJPEG / H.264+ / H.265+	H.265 / H.264 / MJPEG / H.264+ / H.265+	H.265 / H.264 / MJPEG / H.264+ / H.265+	H.265 / H.264 / MJPEG / H.264+ / H.265+	H.265 / H.264 / MJPEG / H.264+ / H.265+
Min. Illumination	0.004 Lux @ (F1.4, AGC ON)	0.0014 Lux @ (F1.4, AGC ON), 0 Lux with IR on	0.0014 Lux @ (F1.4, AGC ON), 0 Lux with IR on	0.004 Lux @ (F1.4, AGC ON), 0 Lux with IR on	0.0014 Lux @ (F1.4, AGC ON), 0 Lux with IR on	0.0014 Lux @ (F1.4, AGC ON), 0 Lux with IR on
WDR	120 dB	140 dB	140 dB	120 dB	140 dB	140 dB
Lens	2.8 mm, 4 mm, 8 mm	"2.8 to 12 mm 8 to 32 mm"	"2.8 to 12 mm 8 to 32 mm"	"2.8 to 12 mm 8 to 32 mm"	"2.8 to 12 mm 8 to 32 mm"	"2.8 to 12 mm 8 to 32 mm"
FOV	2.8 mm @1.4: Horizontal FOV: 107°, vertical FOV: 57°, diagonal FOV: 128° 4 mm @F1.4: Horizontal FOV: 86°, vertical FOV: 46°, diagonal FOV: 102° 8 mm @F1.6: Horizontal FOV: 41°, vertical FOV: 22°, diagonal FOV: 47°	2.8 to 12 mm: horizontal FOV: 107.4° to 39.8°, vertical FOV: 56° to 22.3°, diagonal FOV: 130° to 45.7° 8 to 32 mm: horizontal FOV: 42.5° to 15.1°, vertical FOV: 23.4° to 8.6°, diagonal FOV: 49.6° to 17.3°	2.8 to 12 mm: horizontal FOV 107.4° to 39.8°, vertical FOV 56° to 22.3°, diagonal FOV 130° to 45.7° 8 to 32 mm: horizontal FOV 42.5° to 15.1°, vertical FOV 23.4° to 8.6°, diagonal FOV 49.6° to 17.3°	2.8 to 12 mm: horizontal FOV 107.4° to 39.8°, vertical FOV 56° to 22.3°, diagonal FOV 130° to 45.7° 8 to 32 mm: horizontal FOV 41.8° to 14.9°, vertical FOV 22.9° to 8.5°, diagonal FOV 48.7° to 17.1°	2.8 to 12 mm, horizontal FOV 114.5° to 41.8°, vertical FOV 59.3° to 23.6°, diagonal FOV 141.1° to 48.1° 8 to 32 mm, horizontal FOV 42.5° to 15.1°, vertical FOV 23.4° to 8.6°, diagonal FOV 49.6° to 17.3°	2.8 to 12 mm, horizontal FOV 114.5° to 41.8°, vertical FOV 59.3° to 23.6°, diagonal FOV 141.1° to 48.1° 8 to 32 mm, horizontal FOV 42.5° to 15.1°, vertical FOV 23.4° to 8.6°, diagonal FOV 49.6° to 17.3°
Max. IR Range	30 m	2.8 to 12 mm: 60 m 8 to 32 mm: 100 m	2.8 to 12 mm: 60 m 8 to 32 mm: 100 m	2.8 to 12 mm: 60 m 8 to 32 mm: 100 m	2.8 to 12 mm: 40 m 8 to 32 mm: 60 m	2.8 to 12 mm: 40 m 8 to 32 mm: 60 m
VCA	Line crossing detection, intrusion detection, region entrance detection, region exiting detection	Line crossing detection, intrusion detection, region entrance detection, region exiting detection	Line crossing detection, intrusion detection, region entrance detection, region exiting detection	Line crossing detection, intrusion detection, region entrance detection, region exiting detection	Line crossing detection, intrusion detection, region entrance detection, region exiting detection	Line crossing detection, intrusion detection, region entrance detection, region exiting detection
Frame Rate	50Hz: 25fps (1920 × 1080, 1280 × 960, 1280 × 720) 60Hz: 30fps (1920 × 1080, 1280 × 960, 1280 × 720)	50Hz: 25fps (1920 × 1080, 1280 × 720) 60Hz: 30fps (1920 × 1080, 1280 × 720)	50Hz: 25 fps (2688 × 1520, 2304 × 1296, 1920 × 1080, 1280 × 720) 60Hz: 30 fps (2688 × 1520, 2304 × 1296, 1920 × 1080, 1280 × 720)	50Hz: 20 fps (3840 × 2160, 3072 × 1728) 25 fps (2688 × 1520, 1920 × 1080, 1280 × 720) 60Hz: 20 fps (3840 × 2160, 3072 × 1728) 30 fps (2688 × 1520, 1920 × 1080, 1280 × 720)	50Hz: 25fps (1920 × 1080, 1280 × 720) 60Hz: 30fps (1920 × 1080, 1280 × 720)	50Hz: 25 fps (2688 × 1520, 2304 × 1296, 1920 × 1080, 1280 × 720) 60Hz: 30 fps (2688 × 1520, 2304 × 1296, 1920 × 1080, 1280 × 720)
Multi-Streaming	3	4	4	4	4	4
Protection Level	IP67	IP67,IK10	IP67,IK10	IP67,IK10	IP67,IK10	IP67,IK10
Angle Adjustment	Pan: 0° to 360°, tilt: 0° to 90°, rotate: 0° to 360°	Pan: 0° to 360°, tilt: 0° to 90°, rotate: 0° to 360°	Pan: 0° to 360°, tilt: 0° to 90°, rotate: 0° to 360°	Pan: 0° to 360°, tilt: 0° to 90°, rotate: 0° to 360°	Pan: 0° to 355°, tilt: 0° to 75°, rotate: 0° to 355°	Pan: 0° to 355°, tilt: 0° to 75°, rotate: 0° to 355°
Operating Temperature	-40 °C to +60 °C (-40 °F to +140 °F)	-40 °C to +60 °C (-40 °F to +140 °F)	-40 °C to +60 °C (-40 °F to +140 °F)	-40 °C to +60 °C (-40 °F to +140 °F)	-40 °C to +60 °C (-40 °F to +140 °F)	-40 °C to +60 °C (-40 °F to +140 °F)
Operating Humidity	95% or less	95% or less	95% or less	95% or less	95% or less	95% or less
Local Storage	256 GB	256 GB	256 GB	256 GB	256 GB	256 GB
Audio I/O	-	1 in, 1 out	1 in, 1 out	1 in, 1 out	1 in, 1 out	1 in, 1 out
Alarm I/O	-	3 in, 3 out	3 in, 3 out	3 in, 3 out	2 in, 2 out	2 in, 2 out
Power Supply	12 VDC ± 20%	12 VDC ± 25%, 13W 24 VAC ± 20%, 13W PoE (802.3at, 42.5V to 57V), 15W	12 VDC ± 25%, 13W 24 VAC ± 20%, 13W PoE (802.3at, 42.5V to 57V), 15W	12 VDC ± 25%, 13W 24 VAC ± 20%, 13W PoE (802.3at, 42.5V to 57V), 15W	12 VDC ± 25%, 10.8W 24 VAC ± 20%, 10.8W PoE (802.3af, 36V to 57V), 12.9W	12 VDC ± 25%, 10.8W 24 VAC ± 20%, 10.8W PoE (802.3af, 36V to 57V), 12.9W





DS-2CD3D8662T-IZHS(Y)	DS-2CD3D8662T-IZHS(Y)	DS-2CD302662-IS	DS-2CD305662-IS	DS-2CD308662-IS	DS-2CD312662-IS(U)	DS-2CD315662-IS(U)	
Image	 DarkFighter						
Image Sensor	1/1.8" Progressive Scan CMOS	1/2.8" Progressive Scan CMOS	1/2.7" Progressive Scan CMOS	1/1.8" Progressive Scan CMOS	1/2.8" Progressive Scan CMOS	1/2.7" Progressive Scan CMOS	
Max. Resolution	3840 × 2160	1920 × 1080	2592 × 1944	3840 × 2160	1920 × 1080	2592 × 1944	
Video Compression	H.265 / H.264 / MJPEG / H.264+ / H.265+	H.265 / H.264 / MJPEG / H.264+ / H.265+	H.265 / H.264 / MJPEG / H.264+ / H.265+	H.265 / H.264 / MJPEG / H.264+ / H.265+	H.265 / H.264 / MJPEG / H.264+ / H.265+	H.265 / H.264 / MJPEG / H.264+ / H.265+	
Min. Illumination	0.004 Lux @ (F1.4, AGC ON), 0 Lux with IR on	0.002 Lux @ (F1.4, AGC ON), 0 Lux with IR on	0.003 Lux @ (F1.4, AGC ON), 0 Lux with IR on	0.003 Lux @ (F1.6, AGC ON), 0 Lux with IR on	0.002 Lux @ (F1.4, AGC ON), 0 Lux with IR on	0.003 Lux @ (F1.4, AGC ON), 0 Lux with IR on	
WDR	120 dB	120 dB	120 dB	120 dB	120 dB	120 dB	
Lens	2.8 to 12 mm, 8 to 32 mm	2.8 mm, 4 mm, 6 mm	2.8 mm, 4 mm, 6 mm	2.8 mm, 4 mm, 6 mm	2.8 mm, 4 mm, 6 mm	2.8 mm, 4 mm, 6 mm	
FOV	2.8 to 12 mm: horizontal FOV 112.3° to 41.2°, vertical FOV: 58° to 23°, diagonal FOV 137.3° to 47.3° 8 to 32 mm: horizontal FOV 41.8° to 14.9°, vertical FOV 22.9° to 8.5°, diagonal FOV 48.7° to 17.1°	2.8 mm, horizontal FOV 107°, vertical FOV 57°, diagonal FOV 129° 4 mm, horizontal FOV 86°, vertical FOV 47°, diagonal FOV 102° 6 mm, horizontal FOV 55°, vertical FOV 29°, diagonal FOV 65°	2.8 mm, horizontal FOV 97°, vertical FOV 71°, diagonal FOV 129° 4 mm, horizontal FOV 78°, vertical FOV 58°, diagonal FOV 102° 6 mm, horizontal FOV 44°, vertical FOV 34°, diagonal FOV 54°	2.8 mm, horizontal FOV 111°, vertical FOV 59°, diagonal FOV 131° 4 mm, horizontal FOV 87°, vertical FOV 47°, diagonal FOV 102° 6 mm, horizontal FOV 51°, vertical FOV 28°, diagonal FOV 60°	2.8 mm, horizontal FOV 107°, vertical FOV 57°, diagonal FOV 129° 4 mm, horizontal FOV 86°, vertical FOV 47°, diagonal FOV 102° 6 mm, horizontal FOV 55°, vertical FOV 29°, diagonal FOV 65°	2.8 mm, horizontal FOV 97°, vertical FOV 71°, diagonal FOV 129° 4 mm, horizontal FOV 78°, vertical FOV 58°, diagonal FOV 102° 6 mm, horizontal FOV 44°, vertical FOV 34°, diagonal FOV 54°	2.8 mm, horizontal FOV 97°, vertical FOV 71°, diagonal FOV 129° 4 mm, horizontal FOV 78°, vertical FOV 58°, diagonal FOV 102° 6 mm, horizontal FOV 44°, vertical FOV 34°, diagonal FOV 54°
Max. IR Range	2.8 to 12 mm: 40 m, 8 to 32 mm: 60 m	40 m	40 m	40 m	40 m	40 m	
VCA	Line crossing detection, intrusion detection, region entrance detection, region exiting detection	Line crossing detection, intrusion detection, region entrance detection, region exiting detection	Line crossing detection, intrusion detection, region entrance detection, region exiting detection	Line crossing detection, intrusion detection, region entrance detection, region exiting detection	Line crossing detection, intrusion detection, region entrance detection, region exiting detection	Line crossing detection, intrusion detection, region entrance detection, region exiting detection	
Frame Rate	50Hz: 20 fps (3840 × 2160, 3072 × 1728) 25 fps (2688 × 1520, 1920 × 1080, 1280 × 720) 60Hz: 20 fps (3840 × 2160, 3072 × 1728) 30 fps (2688 × 1520, 1920 × 1080, 1280 × 720)	50Hz: 50fps (1920 × 1080, 1280 × 720) 60Hz: 60fps (1920 × 1080, 1280 × 720)	50Hz: 20 fps (2592 × 1944) 25 fps (2688 × 1520, 2304 × 1296, 1920 × 1080, 1280 × 720) 60Hz: 20 fps (2592 × 1944) 30 fps (2688 × 1520, 2304 × 1296, 1920 × 1080, 1280 × 720)	50Hz: 20 fps (3840 × 2160, 3072 × 1728) 25 fps (2688 × 1520, 1920 × 1080, 1280 × 720) 60Hz: 20 fps (3840 × 2160, 3072 × 1728) 30 fps (2688 × 1520, 1920 × 1080, 1280 × 720)	50Hz: 50fps (1920 × 1080, 1280 × 720) 60Hz: 60fps (1920 × 1080, 1280 × 720)	50Hz: 20 fps (2592 × 1944) 25 fps (2688 × 1520, 2304 × 1296, 1920 × 1080, 1280 × 720) 60Hz: 20 fps (2592 × 1944) 30 fps (2688 × 1520, 2304 × 1296, 1920 × 1080, 1280 × 720)	50Hz: 20 fps (2592 × 1944) 25 fps (2688 × 1520, 2304 × 1296, 1920 × 1080, 1280 × 720) 60Hz: 20 fps (2592 × 1944) 30 fps (2688 × 1520, 2304 × 1296, 1920 × 1080, 1280 × 720)
Multi-Streaming	4	4	4	4	4	4	
Protection Level	IP67,IK10	IP67	IP67	IP67	IP67,IK10	IP67,IK10	
Angle Adjustment	Pan: 0° to 355°, tilt: 0° to 75°, rotate: 0° to 355°	Pan: 0° to 360°, tilt: 0° to 90°, rotate: 0° to 360°	Pan: 0° to 360°, tilt: 0° to 90°, rotate: 0° to 360°	Pan: 0° to 360°, tilt: 0° to 90°, rotate: 0° to 360°	Pan: 0° to 355°, tilt: 0° to 75°, rotate: 0° to 355°	Pan: 0° to 355°, tilt: 0° to 75°, rotate: 0° to 355°	
Operating Temperature	-40 °C to +60 °C (-40 °F to +140 °F)	-30 °C to +60 °C (-22 °F to +140 °F)	-30 °C to +60 °C (-22 °F to +140 °F)	-30 °C to +60 °C (-22 °F to +140 °F)	-30 °C to +60 °C (-22 °F to +140 °F)	-30 °C to +60 °C (-22 °F to +140 °F)	
Operating Humidity	95% or less	95% or less	95% or less	95% or less	95% or less	95% or less	
Local Storage	256 GB	256 GB	256 GB	256 GB	256 GB	256 GB	
Audio I/O	1 in, 1 out	1 in, 1 out	1 in, 1 out	1 in, 1 out	1 in, 1 out, Built-in microphone(-U)	1 in, 1 out, Built-in microphone(-U)	
Alarm I/O	2 in, 2 out	1 in, 1 out	1 in, 1 out	1 in, 1 out	1 in, 1 out	1 in, 1 out	
Power Supply	12 VDC ± 25%, 10.8W 24 VAC ± 20%, 10.8W PoE (802.3af, 36V to 57V), 12.9W	12 VDC ± 25%, 7.2W PoE (802.3af, 36V to 57V), 8.5W	12 VDC ± 25%, 7.2W PoE (802.3af, 36V to 57V), 8.5W	12 VDC ± 25%, 7.2W PoE (802.3af, 36V to 57V), 8.5W	12 VDC ± 25%, 6.5W PoE (802.3af, 36V to 57V), 7.5W	12 VDC ± 25%, 6.5W PoE (802.3af, 36V to 57V), 7.5W	12 VDC ± 25%, 6.5W PoE (802.3af, 36V to 57V), 7.5W

DS-2CD3D86G2T-IZHS(Y)	DS-2CD3186G2-IS(U) NEW	DS-2CD3326G2-IS NEW	DS-2CD3356G2-IS NEW	DS-2CD3386G2-IS NEW	DS-2CD3T26G2-4IS NEW	DS-2CD3T56G2-4IS NEW
Image						
Image Sensor	1/1.8" Progressive Scan CMOS	1/2.8" Progressive Scan CMOS	1/2.7" Progressive Scan CMOS	1/1.8" Progressive Scan CMOS	1/2.8" Progressive Scan CMOS	1/2.7" Progressive Scan CMOS
Max. Resolution	3840 × 2160	1920 × 1080	2592 × 1944	3840 × 2160	1920 × 1080	2592 × 1944
Video Compression	H.265 / H.264 / MJPEG / H.264+ / H.265+	H.265 / H.264 / MJPEG / H.264+ / H.265+	H.265 / H.264 / MJPEG / H.264+ / H.265+	H.265 / H.264 / MJPEG / H.264+ / H.265+	H.265 / H.264 / MJPEG / H.264+ / H.265+	H.265 / H.264 / MJPEG / H.264+ / H.265+
Min. Illumination	0.003 Lux @ (F1.6, AGC ON), 0 Lux with IR on	0.002 Lux @ (F1.4, AGC ON), 0 Lux with IR on	0.003 Lux @ (F1.4, AGC ON), 0 Lux with IR on	0.003 Lux @ (F1.6, AGC ON), 0 Lux with IR on	0.002 Lux @ (F1.4, AGC ON), 0 Lux with IR on	0.003 Lux @ (F1.4, AGC ON), 0 Lux with IR on
WDR	120 dB	120 dB	120 dB	120 dB	120 dB	120 dB
Lens	2.8 mm, 4 mm, 6 mm	2.8 mm, 4 mm, 6 mm	2.8 mm, 4 mm, 6 mm	2.8 mm, 4 mm, 6 mm	2.8 mm, 4 mm, 6 mm, 12 mm	2.8 mm, 4 mm, 6 mm, 12 mm
FOV	2.8 mm, horizontal FOV 111°, vertical FOV 59°, diagonal FOV 131° 4 mm, horizontal FOV 87°, vertical FOV 47°, diagonal FOV 102° 6 mm, horizontal FOV 51°, vertical FOV 28°, diagonal FOV 60°	2.8 mm, horizontal FOV 107°, vertical FOV 57°, diagonal FOV 129° 4 mm, horizontal FOV 86°, vertical FOV 47°, diagonal FOV 102° 6 mm, horizontal FOV 55°, vertical FOV 29°, diagonal FOV 65°	2.8 mm, horizontal FOV 97°, vertical FOV 71°, diagonal FOV 129° 4 mm, horizontal FOV 78°, vertical FOV 58°, diagonal FOV 102° 6 mm, horizontal FOV 44°, vertical FOV 34°, diagonal FOV 54°	2.8 mm, horizontal FOV 111°, vertical FOV 59°, diagonal FOV 131° 4 mm, horizontal FOV 87°, vertical FOV 47°, diagonal FOV 102° 6 mm, horizontal FOV 51°, vertical FOV 28°, diagonal FOV 60°	2.8 mm, horizontal FOV 107°, vertical FOV 57°, diagonal FOV 129° 4 mm, horizontal FOV 86°, vertical FOV 47°, diagonal FOV 102° 6 mm, horizontal FOV 55°, vertical FOV 29°, diagonal FOV 65° 12 mm, horizontal FOV 25°, vertical FOV 14°, diagonal FOV 29°	2.8 mm, horizontal FOV 97°, vertical FOV 71°, diagonal FOV 129° 4 mm, horizontal FOV 78°, vertical FOV 58°, diagonal FOV 102° 6 mm, horizontal FOV 44°, vertical FOV 34°, diagonal FOV 54° 12 mm, horizontal FOV 23°, vertical FOV 18°, diagonal FOV 29°
Max. IR Range	40 m	40 m	40 m	40 m	90 m	90 m
VCA	Line crossing detection, intrusion detection, region entrance detection, region exiting detection	Line crossing detection, intrusion detection, region entrance detection, region exiting detection	Line crossing detection, intrusion detection, region entrance detection, region exiting detection	Line crossing detection, intrusion detection, region entrance detection, region exiting detection	Line crossing detection, intrusion detection, region entrance detection, region exiting detection	Line crossing detection, intrusion detection, region entrance detection, region exiting detection
Frame Rate	50Hz: 20 fps (3840 × 2160, 3072 × 1728) 25 fps (2688 × 1520, 1920 × 1080, 1280 × 720) 60Hz: 20 fps (3840 × 2160, 3072 × 1728) 30 fps (2688 × 1520, 1920 × 1080, 1280 × 720)	50Hz: 50fps (1920 × 1080, 1280 × 720) 60Hz: 60fps (1920 × 1080, 1280 × 720)	50Hz: 20 fps (2592 × 1944) 25 fps (2688 × 1520, 2304 × 1296, 1920 × 1080, 1280 × 720) 60Hz: 20 fps (2592 × 1944) 30 fps (2688 × 1520, 2304 × 1296, 1920 × 1080, 1280 × 720)	50Hz: 20 fps (3840 × 2160, 3072 × 1728) 25 fps (2688 × 1520, 1920 × 1080, 1280 × 720) 60Hz: 20 fps (3840 × 2160, 3072 × 1728) 30 fps (2688 × 1520, 1920 × 1080, 1280 × 720)	50Hz: 50fps (1920 × 1080, 1280 × 720) 60Hz: 60fps (1920 × 1080, 1280 × 720)	50Hz: 20 fps (2592 × 1944) 25 fps (2688 × 1520, 2304 × 1296, 1920 × 1080, 1280 × 720) 60Hz: 20 fps (2592 × 1944) 30 fps (2688 × 1520, 2304 × 1296, 1920 × 1080, 1280 × 720)
Multi-Streaming	4	4	4	4	4	4
Protection Level	IP67,IK10	IP67	IP67	IP67	IP67	IP67
Angle Adjustment	Pan: 0° to 355°, tilt: 0° to 75°, rotate: 0° to 355°	Pan: 0° to 360°, tilt: 0° to 75°, rotate: 0° to 360°	Pan: 0° to 360°, tilt: 0° to 75°, rotate: 0° to 360°	Pan: 0° to 360°, tilt: 0° to 75°, rotate: 0° to 360°	Pan: 0° to 360°, tilt: 0° to 90°, rotate: 0° to 360°	Pan: 0° to 360°, tilt: 0° to 90°, rotate: 0° to 360°
Operating Temperature	-30 °C to +60 °C (-22 °F to +140 °F)	-30 °C to +60 °C (-22 °F to +140 °F)	-30 °C to +60 °C (-22 °F to +140 °F)	-30 °C to +60 °C (-22 °F to +140 °F)	-30 °C to +60 °C (-22 °F to +140 °F)	-30 °C to +60 °C (-22 °F to +140 °F)
Operating Humidity	95% or less	95% or less	95% or less	95% or less	95% or less	95% or less
Local Storage	256 GB	256 GB	256 GB	256 GB	256 GB	256 GB
Audio I/O	1 in, 1 out, Built-in microphone(-U)	1 in, 1 out	1 in, 1 out	1 in, 1 out	1 in, 1 out	1 in, 1 out
Alarm I/O	1 in, 1 out	1 in, 1 out	1 in, 1 out	1 in, 1 out	2 in, 2 out	2 in, 2 out
Power Supply	12 VDC ± 25%, 6.5W PoE (802.3af, 36V to 57V), 7.5W	12 VDC ± 25%, 5.8W PoE (802.3af, 36V to 57V), 6.8W	12 VDC ± 25%, 5.8W PoE (802.3af, 36V to 57V), 6.8W	12 VDC ± 25%, 5.8W PoE (802.3af, 36V to 57V), 6.8W	12 VDC ± 25%, 13W PoE (802.3at, 42.5V to 57V), 14W	12 VDC ± 25%, 13W PoE (802.3at, 42.5V to 57V), 14W







DS-2CD3D8662T-IZHS(Y)	DS-2CD3T8662-4IS	DS-2CD362662-IZS	DS-2CD362662T-IZS	DS-2CD365662-IZS	DS-2CD365662T-IZS	DS-2CD368662-IZS	
Image	 NEW	 NEW	 NEW	 NEW	 NEW	 NEW	
Image Sensor	1/1.8" Progressive Scan CMOS	1/2.8" Progressive Scan CMOS	1/2.8" Progressive Scan CMOS	1/2.7" Progressive Scan CMOS	1/2.7" Progressive Scan CMOS	1/1.8" Progressive Scan CMOS	
Max. Resolution	3840 × 2160	1920 × 1080	1920 × 1080	2592 × 1944	2592 × 1944	3840 × 2160	
Video Compression	H.265 / H.264 / MJPEG / H.264+ / H.265+	H.265 / H.264 / MJPEG / H.264+ / H.265+	H.265 / H.264 / MJPEG / H.264+ / H.265+	H.265 / H.264 / MJPEG / H.264+ / H.265+	H.265 / H.264 / MJPEG / H.264+ / H.265+	H.265 / H.264 / MJPEG / H.264+ / H.265+	
Min. Illumination	0.003 Lux @ (F1.4, AGC ON), 0 Lux with IR on	0.002 Lux @ (F1.4, AGC ON), 0 Lux with IR on	0.002 Lux @ (F1.4, AGC ON), 0 Lux with IR on	0.002 Lux @ (F1.4, AGC ON), 0 Lux with IR on	0.003 Lux @ (F1.4, AGC ON), 0 Lux with IR on	0.003 Lux @ (F1.6, AGC ON), 0 Lux with IR on	
WDR	120 dB	120 dB	120 dB	120 dB	120 dB	120 dB	
Lens	2.8 mm, 4 mm, 6 mm, 12 mm	2.7 to 13.5 mm, 7 to 35 mm	2.7 to 13.5 mm, 7 to 35 mm	2.7 to 13.5 mm, 7 to 35 mm	2.7 to 13.5 mm, 7 to 35 mm	2.7 to 13.5 mm, 7 to 35 mm	
FOV	2.8 mm, horizontal FOV 111°, vertical FOV 59°, diagonal FOV 131° 4 mm, horizontal FOV 87°, vertical FOV 47°, diagonal FOV 102° 6 mm, horizontal FOV 51°, vertical FOV 28°, diagonal FOV 60° 12 mm, horizontal FOV 24°, vertical FOV 14°, diagonal FOV 27°	2.7 to 13.5 mm: horizontal FOV 112.5° to 34°, vertical FOV 57.2° to 18.9°, diagonal FOV 138.1° to 39.1° 7 to 35 mm: horizontal FOV 29.7° to 10.9°, vertical FOV 16.5° to 6.2°, diagonal FOV 34.3° to 12.4°	2.7 to 13.5 mm: horizontal FOV 112.5° to 34°, vertical FOV 57.2° to 18.9°, diagonal FOV 138.1° to 39.1° 7 to 35 mm: horizontal FOV 29.7° to 10.9°, vertical FOV 16.5° to 6.2°, diagonal FOV 34.3° to 12.4°	2.7 to 13.5 mm: horizontal FOV 101° to 31°, vertical FOV 72.2° to 23.4°, diagonal FOV 138.8° to 39.8° 7 to 35 mm: horizontal FOV 27.2° to 10.4°, vertical FOV 20.3° to 7.5°, diagonal FOV 34.4° to 12.5°	2.7 to 13.5 mm: horizontal FOV 101° to 31°, vertical FOV 72.2° to 23.4°, diagonal FOV 138.8° to 39.8° 7 to 35 mm: horizontal FOV 27.2° to 10.4°, vertical FOV 20.3° to 7.5°, diagonal FOV 34.4° to 12.5°	2.7 to 13.5 mm: horizontal FOV 108.1° to 45.5°, vertical FOV 58.4° to 25.7°, diagonal FOV 127.3° to 52.1° 7 to 35 mm: horizontal FOV 41.8° to 14.9°, vertical FOV 22.9° to 8.5°, diagonal FOV 48.7° to 17.1°	2.7 to 13.5 mm: horizontal FOV 108.1° to 45.5°, vertical FOV 58.4° to 25.7°, diagonal FOV 127.3° to 52.1° 7 to 35 mm: horizontal FOV 41.8° to 14.9°, vertical FOV 22.9° to 8.5°, diagonal FOV 48.7° to 17.1°
Max. IR Range	90 m	60 m	2.7 to 13.5 mm: 60 m 7 to 35 mm: 100 m	60 m	2.7 to 13.5 mm: 60 m 7 to 35 mm: 100 m	60 m	
VCA	Line crossing detection, intrusion detection, region entrance detection, region exiting detection	Line crossing detection, intrusion detection, region entrance detection, region exiting detection	Line crossing detection, intrusion detection, region entrance detection, region exiting detection	Line crossing detection, intrusion detection, region entrance detection, region exiting detection	Line crossing detection, intrusion detection, region entrance detection, region exiting detection	Line crossing detection, intrusion detection, region entrance detection, region exiting detection	
Frame Rate	50Hz: 20 fps (3840 × 2160, 3072 × 1728) 25 fps (2688 × 1520, 1920 × 1080, 1280 × 720) 60Hz: 20 fps (3840 × 2160, 3072 × 1728) 30 fps (2688 × 1520, 1920 × 1080, 1280 × 720)	50Hz: 50fps (1920 × 1080, 1280 × 720) 60Hz: 60fps (1920 × 1080, 1280 × 720)	50Hz: 50fps (1920 × 1080, 1280 × 720) 60Hz: 60fps (1920 × 1080, 1280 × 720)	50Hz: 20 fps (2592 × 1944) 25 fps (2688 × 1520, 2304 × 1296, 1920 × 1080, 1280 × 720) 60Hz: 20 fps (2592 × 1944) 30 fps (2688 × 1520, 2304 × 1296, 1920 × 1080, 1280 × 720)	50Hz: 20 fps (2592 × 1944) 25 fps (2688 × 1520, 2304 × 1296, 1920 × 1080, 1280 × 720) 60Hz: 20 fps (2592 × 1944) 30 fps (2688 × 1520, 2304 × 1296, 1920 × 1080, 1280 × 720)	50Hz: 20 fps (3840 × 2160, 3072 × 1728) 25 fps (2688 × 1520, 1920 × 1080, 1280 × 720) 60Hz: 20 fps (3840 × 2160, 3072 × 1728) 30 fps (2688 × 1520, 1920 × 1080, 1280 × 720)	50Hz: 20 fps (3840 × 2160, 3072 × 1728) 25 fps (2688 × 1520, 1920 × 1080, 1280 × 720) 60Hz: 20 fps (3840 × 2160, 3072 × 1728) 30 fps (2688 × 1520, 1920 × 1080, 1280 × 720)
Multi-Streaming	4	4	4	4	4	4	
Protection Level	IP67	IP67,IK10	IP67,IK10	IP67,IK10	IP67,IK10	IP67,IK10	
Angle Adjustment	Pan: 0° to 360°, tilt: 0° to 90°, rotate: 0° to 360°	Pan: 0° to 355°, tilt: 0° to 90°, rotate: 0° to 360°	Pan: 0° to 360°, tilt: 0° to 90°, rotate: 0° to 360°	Pan: 0° to 355°, tilt: 0° to 90°, rotate: 0° to 360°	Pan: 0° to 360°, tilt: 0° to 90°, rotate: 0° to 360°	Pan: 0° to 355°, tilt: 0° to 90°, rotate: 0° to 360°	
Operating Temperature	-30 °C to +60 °C (-22 °F to +140 °F)	-30 °C to +60 °C (-22 °F to +140 °F)	-30 °C to +60 °C (-22 °F to +140 °F)	-30 °C to +60 °C (-22 °F to +140 °F)	-30 °C to +60 °C (-22 °F to +140 °F)	-30 °C to +60 °C (-22 °F to +140 °F)	
Operating Humidity	95% or less	95% or less	95% or less	95% or less	95% or less	95% or less	
Local Storage	256 GB	256 GB	256 GB	256 GB	256 GB	256 GB	
Audio I/O	1 in, 1 out	1 in, 1 out	1 in, 1 out	1 in, 1 out	1 in, 1 out	1 in, 1 out	
Alarm I/O	2 in, 2 out	1 in, 1 out	2 in, 2 out	1 in, 1 out	2 in, 2 out	1 in, 1 out	
Power Supply	12 VDC ± 25%, 13W PoE (802.3at, 42.5V to 57V), 14W	12 VDC ± 25%, 13W PoE (802.3at, 42.5V to 57V), 15W	12 VDC ± 25%, 13.5W PoE (802.3at, 42.5V to 57V), 15W	12 VDC ± 25%, 13W PoE (802.3at, 42.5V to 57V), 15W	12 VDC ± 25%, 13.5W PoE (802.3at, 42.5V to 57V), 15W	12 VDC ± 25%, 13W PoE (802.3at, 42.5V to 57V), 15W	

DS-2CD3D86G2T-IZHS(Y)	DS-2CD3686G2T-IZS	DS-2CD3726G2-IZS	DS-2CD3726G2T-IZS	DS-2CD3756G2-IZS	DS-2CD3756G2T-IZS	DS-2CD3786G2-IZS	
Image	 NEW	 NEW	 NEW	 NEW	 NEW	 NEW	
Image Sensor	1/1.8" Progressive Scan CMOS	1/2.8" Progressive Scan CMOS	1/2.8" Progressive Scan CMOS	1/2.7" Progressive Scan CMOS	1/2.7" Progressive Scan CMOS	1/1.8" Progressive Scan CMOS	
Max. Resolution	3840 × 2160	1920 × 1080	1920 × 1080	2592 × 1944	2592 × 1944	3840 × 2160	
Video Compression	H.265 / H.264 / MJPEG / H.264+ / H.265+	H.265 / H.264 / MJPEG / H.264+ / H.265+	H.265 / H.264 / MJPEG / H.264+ / H.265+	H.265 / H.264 / MJPEG / H.264+ / H.265+	H.265 / H.264 / MJPEG / H.264+ / H.265+	H.265 / H.264 / MJPEG / H.264+ / H.265+	
Min. Illumination	0.003 Lux @ (F1.6, AGC ON), 0 Lux with IR on	0.002 Lux @ (F1.4, AGC ON), 0 Lux with IR on	0.002 Lux @ (F1.4, AGC ON), 0 Lux with IR on	0.003 Lux @ (F1.4, AGC ON), 0 Lux with IR on	0.003 Lux @ (F1.4, AGC ON), 0 Lux with IR on	0.003 Lux @ (F1.6, AGC ON), 0 Lux with IR on	
WDR	120 dB	120 dB	120 dB	120 dB	120 dB	120 dB	
Lens	2.7 to 13.5 mm, 7 to 35 mm	2.7 to 13.5 mm, 7 to 35 mm	2.7 to 13.5 mm, 7 to 35 mm	2.7 to 13.5 mm, 7 to 35 mm	2.7 to 13.5 mm, 7 to 35 mm	2.7 to 13.5 mm, 7 to 35 mm	
FOV	2.7 to 13.5 mm: horizontal FOV 108.1° to 45.5°, vertical FOV 58.4° to 25.7°, diagonal FOV 127.3° to 52.1° 7 to 35 mm: horizontal FOV 41.8° to 14.9°, vertical FOV 22.9° to 8.5°, diagonal FOV 48.7° to 17.1°	2.7 to 13.5 mm: horizontal FOV 112.5° to 34°, vertical FOV 57.2° to 18.9°, diagonal FOV 138.1° to 39.1° 7 to 35 mm: horizontal FOV 29.7° to 10.9°, vertical FOV 16.5° to 6.2°, diagonal FOV 34.3° to 12.4°	2.7 to 13.5 mm: horizontal FOV 112.5° to 34°, vertical FOV 57.2° to 18.9°, diagonal FOV 138.1° to 39.1° 7 to 35 mm: horizontal FOV 29.7° to 10.9°, vertical FOV 16.5° to 6.2°, diagonal FOV 34.3° to 12.4°	2.7 to 13.5 mm: horizontal FOV 101° to 31°, vertical FOV 72.2° to 23.4°, diagonal FOV 138.8° to 39.8° 7 to 35 mm: horizontal FOV 27.2° to 10.4°, vertical FOV 20.3° to 7.5°, diagonal FOV 34.4° to 12.5°	2.7 to 13.5 mm: horizontal FOV 101° to 31°, vertical FOV 72.2° to 23.4°, diagonal FOV 138.8° to 39.8° 7 to 35 mm: horizontal FOV 27.2° to 10.4°, vertical FOV 20.3° to 7.5°, diagonal FOV 34.4° to 12.5°	2.7 to 13.5 mm: horizontal FOV 101° to 31°, vertical FOV 72.2° to 23.4°, diagonal FOV 138.8° to 39.8° 7 to 35 mm: horizontal FOV 27.2° to 10.4°, vertical FOV 20.3° to 7.5°, diagonal FOV 34.4° to 12.5°	2.7 to 13.5 mm: horizontal FOV 108.1° to 45.5°, vertical FOV 58.4° to 25.7°, diagonal FOV 127.3° to 52.1° 7 to 35 mm: horizontal FOV 41.8° to 14.9°, vertical FOV 22.9° to 8.5°, diagonal FOV 48.7° to 17.1°
Max. IR Range	2.7 to 13.5 mm: 60 m 7 to 35 mm: 100 m	40 m	2.7 to 13.5 mm: 40 m 7 to 35 mm: 60 m	40 m	2.7 to 13.5 mm: 40 m 7 to 35 mm: 60 m	40 m	
VCA	Line crossing detection, intrusion detection, region entrance detection, region exiting detection	Line crossing detection, intrusion detection, region entrance detection, region exiting detection	Line crossing detection, intrusion detection, region entrance detection, region exiting detection	Line crossing detection, intrusion detection, region entrance detection, region exiting detection	Line crossing detection, intrusion detection, region entrance detection, region exiting detection	Line crossing detection, intrusion detection, region entrance detection, region exiting detection	
Frame Rate	50Hz: 20 fps (3840 × 2160, 3072 × 1728) 25 fps (2688 × 1520, 1920 × 1080, 1280 × 720) 60Hz: 20 fps (3840 × 2160, 3072 × 1728) 30 fps (2688 × 1520, 1920 × 1080, 1280 × 720)	50Hz: 50fps (1920 × 1080, 1280 × 720) 60Hz: 60fps (1920 × 1080, 1280 × 720)	50Hz: 50fps (1920 × 1080, 1280 × 720) 60Hz: 60fps (1920 × 1080, 1280 × 720)	50Hz: 20 fps (2592 × 1944) 25 fps (2688 × 1520, 2304 × 1296, 1920 × 1080, 1280 × 720) 60Hz: 20 fps (2592 × 1944) 30 fps (2688 × 1520, 2304 × 1296, 1920 × 1080, 1280 × 720)	50Hz: 20 fps (2592 × 1944) 25 fps (2688 × 1520, 2304 × 1296, 1920 × 1080, 1280 × 720) 60Hz: 20 fps (2592 × 1944) 30 fps (2688 × 1520, 2304 × 1296, 1920 × 1080, 1280 × 720)	50Hz: 20 fps (2592 × 1944) 25 fps (2688 × 1520, 2304 × 1296, 1920 × 1080, 1280 × 720) 60Hz: 20 fps (2592 × 1944) 30 fps (2688 × 1520, 2304 × 1296, 1920 × 1080, 1280 × 720)	50Hz: 20 fps (3840 × 2160, 3072 × 1728) 25 fps (2688 × 1520, 1920 × 1080, 1280 × 720) 60Hz: 20 fps (3840 × 2160, 3072 × 1728) 30 fps (2688 × 1520, 1920 × 1080, 1280 × 720)
Multi-Streaming	4	4	4	4	4	4	
Protection Level	IP67,IK10	IP67,IK10	IP67,IK10	IP67,IK10	IP67,IK10	IP67,IK10	
Angle Adjustment	Pan: 0° to 360°, tilt: 0° to 90°, rotate: 0° to 360°	Pan: 0° to 355°, tilt: 0° to 75°, rotate: 0° to 355°	Pan: 0° to 355°, tilt: 0° to 75°, rotate: 0° to 355°	Pan: 0° to 355°, tilt: 0° to 75°, rotate: 0° to 355°	Pan: 0° to 355°, tilt: 0° to 75°, rotate: 0° to 355°	Pan: 0° to 355°, tilt: 0° to 75°, rotate: 0° to 355°	
Operating Temperature	-30 °C to +60 °C (-22 °F to +140 °F)	-30 °C to +60 °C (-22 °F to +140 °F)	-30 °C to +60 °C (-22 °F to +140 °F)	-30 °C to +60 °C (-22 °F to +140 °F)	-30 °C to +60 °C (-22 °F to +140 °F)	-30 °C to +60 °C (-22 °F to +140 °F)	
Operating Humidity	95% or less	95% or less	95% or less	95% or less	95% or less	95% or less	
Local Storage	256 GB	256 GB	256 GB	256 GB	256 GB	256 GB	
Audio I/O	1 in, 1 out	1 in, 1 out	1 in, 1 out	1 in, 1 out	1 in, 1 out	1 in, 1 out	
Alarm I/O	3 in, 3 out	1 in, 1 out	2 in, 2 out	1 in, 1 out	2 in, 2 out	1 in, 1 out	
Power Supply	12 VDC ± 25%, 13.5W PoE (802.3af, 42.5V to 57V), 15W	12 VDC ± 25%, 11W PoE (802.3af, 36V to 57V), 12.9W	12 VDC ± 25%, 11W PoE (802.3af, 36V to 57V), 12.9W	12 VDC ± 25%, 11W PoE (802.3af, 36V to 57V), 12.9W	12 VDC ± 25%, 11W PoE (802.3af, 36V to 57V), 12.9W	12 VDC ± 25%, 11W PoE (802.3af, 36V to 57V), 12.9W	

DS-2CD3D8662T-IZHS(Y)	DS-2CD378662T-IZS	DS-2CD304762-LS	DS-2CD334762-LSU	DS-2CD302662-IU/SL	DS-2CD305662-IU/SL	DS-2CD332662-ISU/SL
Image	 NEW	 NEW	 NEW	 NEW	 NEW	 NEW
Image Sensor	1/1.8" Progressive Scan CMOS	1/1.8" Progressive Scan CMOS	1/1.8" Progressive Scan CMOS	1/2.8" Progressive Scan CMOS	1/2.7" Progressive Scan CMOS	1/2.8" Progressive Scan CMOS
Max. Resolution	3840 × 2160	2688 × 1520	2688 × 1520	1920 × 1080	2592 × 1944	1920 × 1080
Video Compression	H.265 / H.264 / MJPEG / H.264+ / H.265+	H.265 / H.264 / MJPEG / H.264+ / H.265+	H.265 / H.264 / MJPEG / H.264+ / H.265+	H.265 / H.264 / MJPEG / H.264+ / H.265+	H.265 / H.264 / MJPEG / H.264+ / H.265+	H.265 / H.264 / MJPEG / H.264+ / H.265+
Min. Illumination	0.003 Lux @ (F1.6, AGC ON), 0 Lux with IR on	0.0005 Lux @ (F1.0, AGC ON), 0 Lux with light	0.0005 Lux @ (F1.0, AGC ON), 0 Lux with light	0.002 Lux @ (F1.4, AGC ON), 0 Lux with IR on	0.003 Lux @ (F1.4, AGC ON), 0 Lux with IR on	0.002 Lux @ (F1.4, AGC ON), 0 Lux with IR on
WDR	120 dB	130 dB	130 dB	120 dB	120 dB	120 dB
Lens	"2.7 to 13.5 mm 7 to 35 mm"	2.8 mm, 4 mm, 6 mm	2.8 mm, 4 mm, 6 mm	2.8 mm, 4 mm, 6 mm	2.8 mm, 4 mm, 6 mm	2.8 mm, 4 mm, 6 mm
FOV	"2.7 to 13.5 mm: horizontal FOV 108.1° to 45.5°, vertical FOV 58.4° to 25.7°, diagonal FOV 127.3° to 52.1° 7 to 35 mm: horizontal FOV 41.8° to 14.9°, vertical FOV 22.9° to 8.5°, diagonal FOV 48.7° to 17.1°"	"2.8 mm, horizontal FOV 109°, vertical FOV 55°, diagonal FOV 138° 4 mm, horizontal FOV 94°, vertical FOV 49°, diagonal FOV 113° 6 mm, horizontal FOV 57°, vertical FOV 32°, diagonal FOV 66°"	"2.8 mm, horizontal FOV 109°, vertical FOV 55°, diagonal FOV 138° 4 mm, horizontal FOV 94°, vertical FOV 49°, diagonal FOV 113° 6 mm, horizontal FOV 57°, vertical FOV 32°, diagonal FOV 66°"	"2.8 mm, horizontal FOV 107°, vertical FOV 57°, diagonal FOV 129° 4 mm, horizontal FOV 86°, vertical FOV 47°, diagonal FOV 102° 6 mm, horizontal FOV 55°, vertical FOV 29°, diagonal FOV 65°"	"2.8 mm, horizontal FOV 97°, vertical FOV 71°, diagonal FOV 129° 4 mm, horizontal FOV 78°, vertical FOV 58°, diagonal FOV 102° 6 mm, horizontal FOV 44°, vertical FOV 34°, diagonal FOV 54°"	"2.8 mm, horizontal FOV 107°, vertical FOV 57°, diagonal FOV 129° 4 mm, horizontal FOV 86°, vertical FOV 47°, diagonal FOV 102° 6 mm, horizontal FOV 55°, vertical FOV 29°, diagonal FOV 65°"
Max. IR Range	"2.7 to 13.5 mm: 40 m 7 to 35 mm: 60 m"	40 m	40 m	40 m	40 m	40 m
VCA	Line crossing detection, intrusion detection, region entrance detection, region exiting detection	Line crossing detection, intrusion detection, region entrance detection, region exiting detection	Line crossing detection, intrusion detection, region entrance detection, region exiting detection	Line crossing detection, intrusion detection, region entrance detection, region exiting detection	Line crossing detection, intrusion detection, region entrance detection, region exiting detection	Line crossing detection, intrusion detection, region entrance detection, region exiting detection
Frame Rate	"50Hz: 20 fps (3840 × 2160, 3072 × 1728) 25 fps (2688 × 1520, 1920 × 1080, 1280 × 720) 60Hz: 20 fps (3840 × 2160, 3072 × 1728) 30 fps (2688 × 1520, 1920 × 1080, 1280 × 720)"	"50Hz: 25 fps (2688 × 1520, 2304 × 1296, 1920 × 1080, 1280 × 720) 60Hz: 30 fps (2688 × 1520, 2304 × 1296, 1920 × 1080, 1280 × 720)"	"50Hz: 25 fps (2688 × 1520, 2304 × 1296, 1920 × 1080, 1280 × 720) 60Hz: 30 fps (2688 × 1520, 2304 × 1296, 1920 × 1080, 1280 × 720)"	"50Hz: 25fps (1920 × 1080, 1280 × 720) 60Hz: 30fps (1920 × 1080, 1280 × 720)"	"50Hz: 20 fps (2592 × 1944) 25 fps (2688 × 1520, 2304 × 1296, 1920 × 1080, 1280 × 720) 60Hz: 20 fps (2592 × 1944) 30 fps (2688 × 1520, 2304 × 1296, 1920 × 1080, 1280 × 720)"	"50Hz: 25fps (1920 × 1080, 1280 × 720) 60Hz: 30fps (1920 × 1080, 1280 × 720)"
Multi-Streaming	4	4	4	4	4	4
Protection Level	IP67,IK10	IP67	IP67	IP67	IP67	IP67
Angle Adjustment	Pan: 0° to 355°, tilt: 0° to 75°, rotate: 0° to 355°	Pan: 0° to 360°, tilt: 0° to 90°, rotate: 0° to 360°	Pan: 0° to 360°, tilt: 0° to 75°, rotate: 0° to 360°	Pan: 0° to 360°, tilt: 0° to 90°, rotate: 0° to 360°	Pan: 0° to 360°, tilt: 0° to 90°, rotate: 0° to 360°	Pan: 0° to 360°, tilt: 0° to 75°, rotate: 0° to 360°
Operating Temperature	-30 °C to +60 °C (-22 °F to +140 °F)	-30 °C to +60 °C (-22 °F to +140 °F)	-30 °C to +60 °C (-22 °F to +140 °F)	-30 °C to +60 °C (-22 °F to +140 °F)	-30 °C to +60 °C (-22 °F to +140 °F)	-30 °C to +60 °C (-22 °F to +140 °F)
Operating Humidity	95% or less	95% or less	95% or less	95% or less	95% or less	95% or less
Local Storage	256 GB	256 GB	256 GB	256 GB	256 GB	256 GB
Audio I/O	1 in, 1 out	1 in, 1 out	1 in, 1 out, Built-in microphone	1 built-in microphone 1 built-in speaker	1 built-in microphone 1 built-in speaker	1 in, 1 out, Built-in microphone Built-in speaker
Alarm I/O	2 in, 2 out	2 in, 2 out	1 in, 1 out	-	-	1 in, 1 out
Power Supply	"12 VDC ± 25%, 11W PoE (802.3af, 36V to 57V), 12.9W"	12 VDC ± 25%, 7.5W PoE (802.3af, 36V to 57V), 9W	12 VDC ± 25%, 7.2W PoE (802.3af, 36V to 57V), 8.2W	12 VDC ± 25%, 6.5W PoE (802.3af, 36V to 57V), 8W	12 VDC ± 25%, 6.5W PoE (802.3af, 36V to 57V), 8W	12 VDC ± 25%, 7.2W PoE (802.3af, 36V to 57V), 8.2W

DS-2CD3D86G2T-IZHS(Y)	DS-2CD3356G2-ISU/SL	DS-2CD3T26G2-ISU/SL	DS-2CD3T56G2-ISU/SL	DS-2CD302360-I	DS-2CD304360-I	DS-2CD306360-I
Image	 NEW	 NEW	 NEW			
Image Sensor	1/2.7" Progressive Scan CMOS	1/2.8" Progressive Scan CMOS	1/2.7" Progressive Scan CMOS	1/2.8" Progressive Scan CMOS	1/3" Progressive Scan CMOS	1/2.9" Progressive Scan CMOS
Max. Resolution	2592 × 1944	1920 × 1080	2592 × 1944	1920 × 1080	2688 × 1520	3072 × 2048
Video Compression	H.265 / H.264 / MJPEG / H.264+ / H.265+	H.265 / H.264 / MJPEG / H.264+ / H.265+	H.265 / H.264 / MJPEG / H.264+ / H.265+	H.265 / H.264 / MJPEG / H.264+ / H.265+	H.265 / H.264 / MJPEG / H.264+ / H.265+	H.265 / H.264 / MJPEG / H.264+ / H.265+
Min. Illumination	0.003 Lux @ (F1.4, AGC ON), 0 Lux with IR on	0.002 Lux @ (F1.4, AGC ON), 0 Lux with IR on	0.003 Lux @ (F1.4, AGC ON), 0 Lux with IR on	Color: 0.028 Lux @ (F2.0, AGC ON), 0 Lux with IR	Color: 0.018 Lux @ (F1.6, AGC ON), 0 Lux with IR	Color: 0.028 lux @(F2.0, AGC ON), 0 lux with IR
WDR	120 dB	120 dB	120 dB	120 dB	120 dB	120 dB
Lens	2.8 mm, 4 mm, 6 mm	2.8 mm, 4 mm, 6 mm	2.8 mm, 4 mm, 6 mm	2.8, 4 or 6 mm	2.8, 4 or 6 mm	2.8, 4 or 6 mm
FOV	2.8 mm, horizontal FOV 97°, vertical FOV 71°, diagonal FOV 129° 4 mm, horizontal FOV 78°, vertical FOV 58°, diagonal FOV 102° 6 mm, horizontal FOV 44°, vertical FOV 34°, diagonal FOV 54°	2.8 mm, horizontal FOV 107°, vertical FOV 57°, diagonal FOV 129° 4 mm, horizontal FOV 86°, vertical FOV 47°, diagonal FOV 102° 6 mm, horizontal FOV 55°, vertical FOV 29°, diagonal FOV 65°	2.8 mm, horizontal FOV 97°, vertical FOV 71°, diagonal FOV 129° 4 mm, horizontal FOV 78°, vertical FOV 58°, diagonal FOV 102° 6 mm, horizontal FOV 44°, vertical FOV 34°, diagonal FOV 54°	2.8 mm, horizontal FOV: 103°, vertical FOV: 59°, diagonal FOV: 118° 4 mm, horizontal FOV: 86°, vertical FOV: 46°, diagonal FOV: 102° 6 mm, horizontal FOV: 54°, vertical FOV: 30°, diagonal FOV: 62°	2.8 mm, horizontal FOV: 103°, vertical FOV: 58°, diagonal FOV: 123° 4 mm, horizontal FOV: 83°, vertical FOV: 45°, diagonal FOV: 99° 6 mm, horizontal FOV: 51°, vertical FOV: 29°, diagonal FOV: 58°	2.8 mm, horizontal FOV: 97°, vertical FOV: 63°, diagonal FOV: 120° 4 mm, horizontal FOV: 78°, vertical FOV: 50°, diagonal FOV: 97° 6 mm, horizontal FOV: 60°, vertical FOV: 39°, diagonal FOV: 75°
Max. IR Range	40 m	60 m	60 m	40 m	40 m	40 m
VCA	Line crossing detection, intrusion detection, region entrance detection, region exiting detection	Line crossing detection, intrusion detection, region entrance detection, region exiting detection	Line crossing detection, intrusion detection, region entrance detection, region exiting detection	Line crossing detection, intrusion detection, unattended baggage detection, object removal detection, face detection, scene change detection	Line crossing detection, intrusion detection, unattended baggage detection, object removal detection, face detection, scene change detection	Line crossing detection, intrusion detection, unattended baggage detection, object removal detection, face detection, scene change detection
Frame Rate	50Hz: 20 fps (2592 × 1944) 25 fps (2688 × 1520, 2304 × 1296, 1920 × 1080, 1280 × 720) 60Hz: 20 fps (2592 × 1944) 30 fps (2688 × 1520, 2304 × 1296, 1920 × 1080, 1280 × 720)	50Hz: 25fps (1920 × 1080, 1280 × 720) 60Hz: 30fps (1920 × 1080, 1280 × 720)	50Hz: 20 fps (2592 × 1944) 25 fps (2688 × 1520, 2304 × 1296, 1920 × 1080, 1280 × 720) 60Hz: 20 fps (2592 × 1944) 30 fps (2688 × 1520, 2304 × 1296, 1920 × 1080, 1280 × 720)	50Hz: 25fps (1920 × 1080, 1280 × 960, 1280 × 720) 60Hz: 30fps (1920 × 1080, 1280 × 960, 1280 × 720)	50Hz: 25fps (2688 × 1520, 2560 × 1440, 2304 × 1296, 1920 × 1080) 60Hz: 30fps (2688 × 1520, 2560 × 1440, 2304 × 1296, 1920 × 1080)	50Hz: 20 fps (3072 × 2048, 3072 × 1728, 2944 × 1656), 25 fps (2560 × 1440, 1920 × 1080, 1280 × 720) 60Hz: 20 fps (3072 × 2048, 3072 × 1728, 2944 × 1656), 30fps (2560 × 1440, 1920 × 1080, 1280 × 720)
Multi-Streaming	4	4	4	3	3	3
Protection Level	IP67	IP67	IP67	IP67	IP67	IP67
Angle Adjustment	Pan: 0° to 360°, tilt: 0° to 75°, rotate: 0° to 360°	Pan: 0° to 360°, tilt: 0° to 90°, rotate: 0° to 360°	Pan: 0° to 360°, tilt: 0° to 90°, rotate: 0° to 360°	Pan: 0° to 360°, tilt: 0° to 90°, rotate: 0° to 360°	Pan: 0° to 360°, tilt: 0° to 90°, rotate: 0° to 360°	Pan: 0° to 360°, tilt: 0° to 90°, rotate: 0° to 360°
Operating Temperature	-30 °C to +60 °C (-22 °F to +140 °F)	-30 °C to +60 °C (-22 °F to +140 °F)	-30 °C to +60 °C (-22 °F to +140 °F)	-30 °C to +60 °C (-22 °F to +140 °F)	-30 °C to +60 °C (-22 °F to +140 °F)	-30 °C to +60 °C (-22 °F to +140 °F)
Operating Humidity	95% or less	95% or less	95% or less	95% or less	95% or less	95% or less
Local Storage	256 GB	256 GB	256 GB	128 GB	128 GB	128 GB
Audio I/O	1 in, 1 out, Built-in microphone Built-in speaker	1 in, 1 out, Built-in microphone Built-in speaker	1 in, 1 out, Built-in microphone Built-in speaker	-	-	-
Alarm I/O	1 in, 1 out	2 in, 2 out	2 in, 2 out	-	-	-
Power Supply	12 VDC ± 25%, 7.8W PoE (802.3af, 36V to 57V), 8.8W	12 VDC ± 25%, 12W PoE (802.3at, 42.5V to 57V), 13W	12 VDC ± 25%, 12W PoE (802.3at, 42.5V to 57V), 13W	12 VDC ± 25%, 6W PoE (802.3af, 37V to 57V), 7.5W	12 VDC ± 25%, 6W PoE (802.3af, 37V to 57V), 7.5W	12 VDC ± 25%, 6W PoE (802.3af, 37V to 57V), 7.5W

Model	DS-2CD312360-I(S)	DS-2CD314360-I(S)	DS-2CD316360-I(S)	DS-2CD332360-I	DS-2CD334360-I	DS-2CD336360-I	
Image							
Image Sensor	1/2.8" Progressive Scan CMOS	1/3" Progressive Scan CMOS	1/2.9" Progressive Scan CMOS	1/2.8" Progressive Scan CMOS	1/3" Progressive Scan CMOS	1/2.9" Progressive Scan CMOS	
Max. Resolution	1920 × 1080	2688 × 1520	3072 × 2048	1920 × 1080	2688 × 1520	3072 × 2048	
Video Compression	H.265 / H.264 / MJPEG / H.264+ / H.265+	H.265 / H.264 / MJPEG / H.264+ / H.265+	H.265 / H.264 / MJPEG / H.264+ / H.265+	H.265 / H.264 / MJPEG / H.264+ / H.265+	H.265 / H.264 / MJPEG / H.264+ / H.265+	H.265 / H.264 / MJPEG / H.264+ / H.265+	
Min. Illumination	Color: 0.028 Lux @ (F2.0, AGC ON), 0 Lux with IR	Color: 0.018 Lux @ (F1.6, AGC ON), 0 Lux with IR	Color: 0.028 lux @ (F2.0, AGC ON), 0 lux with IR	Color: 0.028 Lux @ (F2.0, AGC ON), 0 Lux with IR	Color: 0.018 Lux @ (F1.6, AGC ON), 0 Lux with IR	Color: 0.028 lux @ (F2.0, AGC ON), 0 lux with IR	
WDR	120 dB	120 dB	120 dB	120 dB	120 dB	120 dB	
Lens	2.8, 4 or 6 mm	2.8, 4 or 6 mm	2.8, 4 or 6 mm	2.8, 4 or 6 mm	2.8, 4 or 6 mm	2.8, 4 or 6 mm	
FOV	2.8 mm, horizontal FOV: 114°, vertical FOV: 62°, diagonal FOV: 135° 4 mm, horizontal FOV: 86°, vertical FOV: 46°, diagonal FOV: 102° 6 mm, horizontal FOV: 54°, vertical FOV: 30°, diagonal FOV: 62°	2.8 mm, horizontal FOV: 103°, vertical FOV: 58°, diagonal FOV: 123° 4 mm, horizontal FOV: 83°, vertical FOV: 45°, diagonal FOV: 99° 6 mm, horizontal FOV: 51°, vertical FOV: 29°, diagonal FOV: 58°	2.8 mm, horizontal FOV: 97°, vertical FOV: 63°, diagonal FOV: 120° 4 mm, horizontal FOV: 78°, vertical FOV: 50°, diagonal FOV: 97° 6 mm, horizontal FOV: 60°, vertical FOV: 39°, diagonal FOV: 75°	2.8 mm, horizontal FOV: 114°, vertical FOV: 62°, diagonal FOV: 135° 4 mm, horizontal FOV: 86°, vertical FOV: 46°, diagonal FOV: 102° 6 mm, horizontal FOV: 54°, vertical FOV: 30°, diagonal FOV: 62°	2.8 mm, horizontal FOV: 103°, vertical FOV: 58°, diagonal FOV: 123° 4 mm, horizontal FOV: 83°, vertical FOV: 45°, diagonal FOV: 99° 6 mm, horizontal FOV: 51°, vertical FOV: 29°, diagonal FOV: 58°	2.8 mm, horizontal FOV: 97°, vertical FOV: 63°, diagonal FOV: 120° 4 mm, horizontal FOV: 78°, vertical FOV: 50°, diagonal FOV: 97° 6 mm, horizontal FOV: 60°, vertical FOV: 39°, diagonal FOV: 75°	2.8 mm, horizontal FOV: 97°, vertical FOV: 63°, diagonal FOV: 120° 4 mm, horizontal FOV: 78°, vertical FOV: 50°, diagonal FOV: 97° 6 mm, horizontal FOV: 60°, vertical FOV: 39°, diagonal FOV: 75°
Max. IR Range	40 m	40 m	40 m	40 m	40 m	40 m	
VCA	Line crossing detection, intrusion detection, unattended baggage detection, object removal detection, face detection, scene change detection	Line crossing detection, intrusion detection, unattended baggage detection, object removal detection, face detection, scene change detection	Line crossing detection, intrusion detection, unattended baggage detection, object removal detection, face detection, scene change detection	Line crossing detection, intrusion detection, unattended baggage detection, object removal detection, face detection, scene change detection	Line crossing detection, intrusion detection, unattended baggage detection, object removal detection, face detection, scene change detection	Line crossing detection, intrusion detection, unattended baggage detection, object removal detection, face detection, scene change detection	
Frame Rate	50Hz: 25fps (1920 × 1080, 1280 × 960, 1280 × 720) 60Hz: 30fps (1920 × 1080, 1280 × 960, 1280 × 720)	50Hz: 25fps (2688 × 1520, 2560 × 1440, 2304 × 1296, 1920 × 1080) 60Hz: 30fps (2688 × 1520, 2560 × 1440, 2304 × 1296, 1920 × 1080)	50Hz: 20 fps (3072 × 2048, 3072 × 1728, 2944 × 1656), 25 fps (2560 × 1440, 1920 × 1080, 1280 × 720) 60Hz: 20 fps (3072 × 2048, 3072 × 1728, 2944 × 1656), 30fps (2560 × 1440, 1920 × 1080, 1280 × 720)	50Hz: 25fps (1920 × 1080, 1280 × 960, 1280 × 720) 60Hz: 30fps (1920 × 1080, 1280 × 960, 1280 × 720)	50Hz: 25fps (2688 × 1520, 2560 × 1440, 2304 × 1296, 1920 × 1080) 60Hz: 30fps (2688 × 1520, 2560 × 1440, 2304 × 1296, 1920 × 1080)	50Hz: 20 fps (3072 × 2048, 3072 × 1728, 2944 × 1656), 25 fps (2560 × 1440, 1920 × 1080, 1280 × 720) 60Hz: 20 fps (3072 × 2048, 3072 × 1728, 2944 × 1656), 30fps (2560 × 1440, 1920 × 1080, 1280 × 720)	50Hz: 20 fps (3072 × 2048, 3072 × 1728, 2944 × 1656), 25 fps (2560 × 1440, 1920 × 1080, 1280 × 720) 60Hz: 20 fps (3072 × 2048, 3072 × 1728, 2944 × 1656), 30fps (2560 × 1440, 1920 × 1080, 1280 × 720)
Multi-Streaming	3	3	3	3	3	3	
Protection Level	IP67, IK10	IP67, IK10	IP67, IK10	IP67	IP67	IP67	
Angle Adjustment	Pan: 0° to 355°, tilt: 0° to 75°, rotate: 0° to 355°	Pan: 0° to 355°, tilt: 0° to 75°, rotate: 0° to 355°	Pan: 0° to 355°, tilt: 0° to 75°, rotate: 0° to 355°	Pan: 0° to 360°, tilt: 0° to 75°, rotate: 0° to 360°	Pan: 0° to 360°, tilt: 0° to 75°, rotate: 0° to 360°	Pan: 0° to 360°, tilt: 0° to 75°, rotate: 0° to 360°	
Operating Temperature	-30 °C to +60 °C (-22 °F to +140 °F)	-30 °C to +60 °C (-22 °F to +140 °F)	-30 °C to +60 °C (-22 °F to +140 °F)	-30 °C to +60 °C (-22 °F to +140 °F)	-30 °C to +60 °C (-22 °F to +140 °F)	-30 °C to +60 °C (-22 °F to +140 °F)	
Operating Humidity	95% or less	95% or less	95% or less	95% or less	95% or less	95% or less	
Local Storage	128 GB	128 GB	128 GB	128 GB	128 GB	128 GB	
Audio I/O	With -S model: 1 in, 1 out	With -S model: 1 in, 1 out	With -S model: 1 in, 1 out	-	-	-	
Alarm I/O	With -S model: 1 in, 1 out	With -S model: 1 in, 1 out	With -S model: 1 in, 1 out	-	-	-	
Power Supply	12 VDC ± 25%, 6W PoE (802.3af, class 3), 7.5W	12 VDC ± 25%, 6W PoE (802.3af, 37V to 57V), 7.5W	12 VDC ± 25%, 7.5W PoE (802.3af, 37V to 57V), 9W	12 VDC ± 25%, 6W PoE (802.3af, 37V to 57V), 7.5W	12 VDC ± 25%, 6W PoE (802.3af, 37V to 57V), 7.5W	12 VDC ± 25%, 6W PoE (802.3af, 37V to 57V), 7.5W	

Model	DS-2CD362361-IZ(S)	DS-2CD364361-IZ(S)	DS-2CD366361-IZ(S)	DS-2CD372361-IZ(S)	DS-2CD374361-IZ(S)	DS-2CD376361-IZ(S)
Image						
Image Sensor	1/2.8" Progressive Scan CMOS	1/3" Progressive Scan CMOS	1/2.9" Progressive Scan CMOS	1/2.8" Progressive Scan CMOS	1/3" Progressive Scan CMOS	1/2.9" Progressive Scan CMOS
Max. Resolution	1920 × 1080	2688 × 1520	3072 × 2048	1920 × 1080	2688 × 1520	3072 × 2048
Video Compression	H.265 / H.264 / MJPEG / H.264+ / H.265+	H.265 / H.264 / MJPEG / H.264+ / H.265+	H.265 / H.264 / MJPEG / H.264+ / H.265+	H.265 / H.264 / MJPEG / H.264+ / H.265+	H.265 / H.264 / MJPEG / H.264+ / H.265+	H.265 / H.264 / MJPEG / H.264+ / H.265+
Min. Illumination	Color: 0.018 Lux @ (F1.6, AGC ON), 0 Lux with IR	Color: 0.018 Lux @ (F1.6, AGC ON), 0 Lux with IR	Color: 0.018 Lux @ (F1.6, AGC ON), 0 Lux with IR	Color: 0.018 Lux @ (F1.6, AGC ON), 0 Lux with IR	Color: 0.018 Lux @ (F1.6, AGC ON), 0 Lux with IR	Color: 0.018 Lux @ (F1.6, AGC ON), 0 Lux with IR
WDR	120 dB	120 dB	120 dB	120 dB	120 dB	120 dB
Lens	2.7 to 13.5 mm	2.7 to 13.5 mm	2.7 to 13.5 mm	2.7 to 13.5 mm	2.7 to 13.5 mm	2.7 to 13.5 mm
FOV	horizontal FOV: 110° to 31° vertical FOV: 58° to 18° diagonal FOV: 136° to 36°	horizontal FOV: 104° to 29° vertical FOV: 55° to 17° diagonal FOV: 125° to 34°	Horizontal field of view: 88° to 27° Vertical field of view: 56° to 18° Diagonal field of view: 110° to 33°	horizontal FOV: 110° to 31° vertical FOV: 58° to 18° diagonal FOV: 136° to 36°	horizontal FOV: 104° to 29° vertical FOV: 55° to 17° diagonal FOV: 125° to 34°	Horizontal field of view: 88° to 27° Vertical field of view: 56° to 18° Diagonal field of view: 110° to 33°
Max. IR Range	60 m	60 m	60 m	40 m	40 m	40 m
VCA	Line crossing detection, intrusion detection, unattended baggage detection, object removal detection, face detection, scene change detection	Line crossing detection, intrusion detection, unattended baggage detection, object removal detection, face detection, scene change detection	Line crossing detection, intrusion detection, unattended baggage detection, object removal detection, face detection, scene change detection	Line crossing detection, intrusion detection, unattended baggage detection, object removal detection, face detection, scene change detection	Line crossing detection, intrusion detection, unattended baggage detection, object removal detection, face detection, scene change detection	Line crossing detection, intrusion detection, unattended baggage detection, object removal detection, face detection, scene change detection
Frame Rate	50Hz: 25fps (1920 × 1080, 1280 × 960, 1280 × 720) 60Hz: 30fps (1920 × 1080, 1280 × 960, 1280 × 720)	50Hz: 25fps (2688 × 1520, 2560 × 1440, 2304 × 1296, 1920 × 1080) 60Hz: 30fps (2688 × 1520, 2560 × 1440, 2304 × 1296, 1920 × 1080)	50Hz: 20 fps (3072 × 2048, 3072 × 1728, 2944 × 1656), 25 fps (2560 × 1440, 1920 × 1080, 1280 × 720) 60Hz: 20 fps (3072 × 2048, 3072 × 1728, 2944 × 1656), 30fps (2560 × 1440, 1920 × 1080, 1280 × 720)	50Hz: 25fps (1920 × 1080, 1280 × 960, 1280 × 720) 60Hz: 30fps (1920 × 1080, 1280 × 960, 1280 × 720)	50Hz: 25fps (2688 × 1520, 2560 × 1440, 2304 × 1296, 1920 × 1080) 60Hz: 30fps (2688 × 1520, 2560 × 1440, 2304 × 1296, 1920 × 1080)	50Hz: 20 fps (3072 × 2048, 3072 × 1728, 2944 × 1656), 25 fps (2560 × 1440, 1920 × 1080, 1280 × 720) 60Hz: 20 fps (3072 × 2048, 3072 × 1728, 2944 × 1656), 30fps (2560 × 1440, 1920 × 1080, 1280 × 720)
Multi-Streaming	3	3	3	3	3	3
Protection Level	IP67, IK10	IP67, IK10	IP67, IK10	IP67, IK10	IP67, IK10	IP67, IK10
Angle Adjustment	Pan: 0° to 360°, tilt: 0° to 90°, rotate: 0° to 360°	Pan: 0° to 360°, tilt: 0° to 90°, rotate: 0° to 360°	Pan: 0° to 355°, tilt: 0° to 90°, rotate: 0° to 355°	Pan: 0° to 355°, tilt: 0° to 75°, rotate: 0° to 355°	Pan: 0° to 355°, tilt: 0° to 75°, rotate: 0° to 355°	Pan: 0° to 355°, tilt: 0° to 75°, rotate: 0° to 355°
Operating Temperature	-30 °C to +60 °C (-22 °F to +140 °F)	-30 °C to +60 °C (-22 °F to +140 °F)	-30 °C to +60 °C (-22 °F to +140 °F)	-30 °C to +60 °C (-22 °F to +140 °F)	-30 °C to +60 °C (-22 °F to +140 °F)	-30 °C to +60 °C (-22 °F to +140 °F)
Operating Humidity	95% or less	95% or less	95% or less	95% or less	95% or less	95% or less
Local Storage	128 GB	128 GB	128 GB	128 GB	128 GB	128 GB
Audio I/O	With -S model: 1 in, 1 out	With -S model: 1 in, 1 out	With -S model: 1 in, 1 out	With -S model: 1 in, 1 out	With -S model: 1 in, 1 out	With -S model: 1 in, 1 out
Alarm I/O	With -S model: 1 in, 1 out	With -S model: 1 in, 1 out	With -S model: 1 in, 1 out	With -S model: 1 in, 1 out	With -S model: 1 in, 1 out	With -S model: 1 in, 1 out
Power Supply	12 VDC ± 25%, 14.5W PoE (802.3at, 42.5V to 57V), 18W	12 VDC ± 25%, 14.5W PoE (802.3at, 42.5V to 57V), 18W	12 VDC ± 25%, 14.5W PoE (802.3at, 42.5V to 57V), 18W	12 VDC ± 25%, 10W PoE (802.3af, 37V to 57V), 12W	12 VDC ± 25%, 10W PoE (802.3af, 37V to 57V), 12W	12 VDC ± 25%, 10W PoE (802.3af, 36V to 57V), 12W

Model	DS-2CD3T2360-2(SI)/4(S)	DS-2CD3T4360-2(SI)/4(S)	DS-2CD3T6360-2(SI)/4(S)	DS-2CD382360
Image				
Image Sensor	1/2.8" Progressive Scan CMOS	1/3" Progressive Scan CMOS	1/2.9" Progressive Scan CMOS	1/2.7" Progressive Scan CMOS
Max. Resolution	1920 × 1080	2688 × 1520	3072 × 2048	1920 × 1080
Video Compression	H.265 / H.264 / MJPEG / H.264+ / H.265+	H.265 / H.264 / MJPEG / H.264+ / H.265+	H.265 / H.264 / MJPEG / H.264+ / H.265+	H.265 / H.264 / MJPEG / H.264+ / H.265+
Min. Illumination	Color: 0.028 Lux @ (F2.0, AGC ON), 0 Lux with IR	Color: 0.018 Lux @ (F1.6, AGC ON), 0 Lux with IR	Color: 0.028 Lux @ (F2.0, AGC ON), 0 lux with IR	Color: 0.005 Lux @ (F1.2, AGC ON)
WDR	120 dB	120 dB	120 dB	DWDR
Lens	2.8, 4 or 6 mm	2.8, 4 or 6 mm	2.8, 4 or 6 mm	2.7 to 10 mm, 2.7 to 13 mm, or 5 to 50 mm
FOV	2.8 mm, horizontal FOV: 114°, vertical FOV: 62°, diagonal FOV: 135° 4 mm, horizontal FOV: 86°, vertical FOV: 46°, diagonal FOV: 102° 6 mm, horizontal FOV: 54°, vertical FOV: 30°, diagonal FOV: 62°	2.8 mm, horizontal FOV: 103°, vertical FOV: 58°, diagonal FOV: 123° 4 mm, horizontal FOV: 83°, vertical FOV: 45°, diagonal FOV: 99° 6 mm, horizontal FOV: 51°, vertical FOV: 29°, diagonal FOV: 58°	2.8 mm, horizontal FOV: 97°, vertical FOV: 63°, diagonal FOV: 120° 4 mm, horizontal FOV: 78°, vertical FOV: 50°, diagonal FOV: 97° 6 mm, horizontal FOV: 60°, vertical FOV: 39°, diagonal FOV: 75°	2.7 to 10 mm: horizontal FOV: 105.8° to 35.1°, vertical FOV: 55.8° to 19.7°, diagonal FOV: 126.5° to 40.3° 2.7 to 13 mm: horizontal FOV: 106.5° to 26.4°, vertical FOV: 58.4° to 14.9°, diagonal FOV: 123.6° to 30.3° 5 to 50 mm: horizontal FOV: 55.2° to 6.4°, vertical FOV: 31.1° to 3.6°, diagonal FOV: 63.2° to 7.3°
Max. IR Range	-2l: 60 m -4l: 90 m	-2l: 60 m -4l: 90 m	-2l: 60 m -4l: 90 m	-
VCA	Line crossing detection, intrusion detection, unattended baggage detection, object removal detection, face detection, scene change detection	Line crossing detection, intrusion detection, unattended baggage detection, object removal detection, face detection, scene change detection	Line crossing detection, intrusion detection, unattended baggage detection, object removal detection, face detection, scene change detection	Line crossing detection, intrusion detection
Frame Rate	50Hz: 25fps (1920 × 1080, 1280 × 960, 1280 × 720) 60Hz: 30fps (1920 × 1080, 1280 × 960, 1280 × 720)	50Hz: 25fps (2688 × 1520, 2560 × 1440, 2304 × 1296, 1920 × 1080) 60Hz: 30fps (2688 × 1520, 2560 × 1440, 2304 × 1296, 1920 × 1080)	50Hz: 20 fps (3072 × 2048, 3072 × 1728, 2944 × 1656), 25 fps (2560 × 1440, 1920 × 1080, 1280 × 720) 60Hz: 20 fps (3072 × 2048, 3072 × 1728, 2944 × 1656), 30fps (2560 × 1440, 1920 × 1080, 1280 × 720)	50Hz: 25fps (1920 × 1080, 1280 × 960, 1280 × 720) 60Hz: 30fps (1920 × 1080, 1280 × 960, 1280 × 720)
Multi-Streaming	3	3	3	3
Protection Level	IP67	IP67	IP67	-
Angle Adjustment	Pan: 0° to 360°, tilt: 0° to 100°, rotate: 0° to 360°	Pan: 0° to 360°, tilt: 0° to 100°, rotate: 0° to 360°	Pan: 0° to 360°, tilt: 0° to 100°, rotate: 0° to 360°	-
Operating Temperature	-30 °C to +60 °C [-22 °F to +140 °F]	-30 °C to +60 °C [-22 °F to +140 °F]	-30 °C to +60 °C [-22 °F to +140 °F]	-10 °C to 50 °C [14 °F to 122 °F]
Operating Humidity	95% or less	95% or less	95% or less	95% or less
Local Storage	128 GB	128 GB	128 GB	128 GB
Audio I/O	With -S model: 1 in, 1 out	With -S model: 1 in, 1 out	With -S model: 1 in, 1 out	1 in, 1 out, 1 mic in
Alarm I/O	With -S model: 1 in, 1 out	With -S model: 1 in, 1 out	With -S model: 1 in, 1 out	1 in, 1 out
Power Supply	2l: 12 VDC ± 25%, 7.5W PoE (802.3af, class 3), 9.5W 4l: 12 VDC ± 25%, 11.5W PoE (802.3af, class 3), 12.5W	2l: 12 VDC ± 25%, 7.5W PoE (802.3af, class 3), 9.5W 4l: 12 VDC ± 25%, 11.5W PoE (802.3af, class 3), 12.5W	2l: 12 VDC ± 25%, 7W PoE (802.3af, class 3), 8.5W 4l: 12 VDC ± 25%, 10W PoE (802.3af, class 3), 12W	DC: 12 V ± 25% AC: 24 V ± 20% PoE (802.3af, class 3), two-core terminal block

Special Series Network Cameras



Fits Anywhere, Monitors Everything

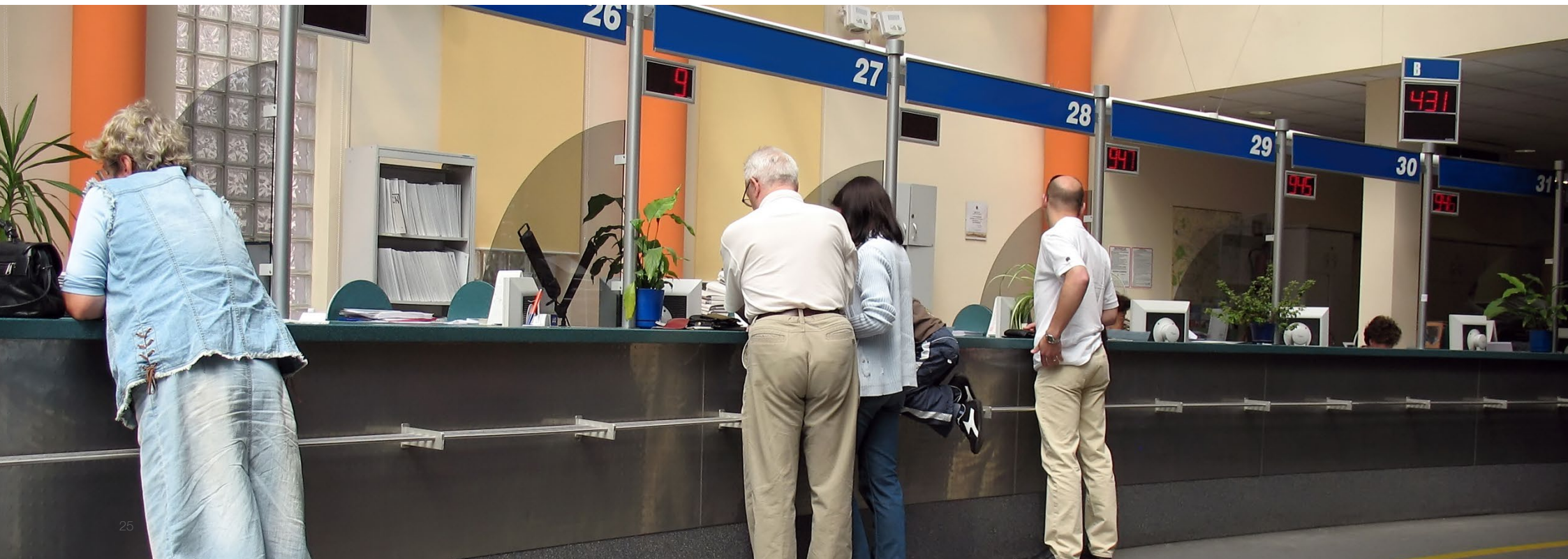

- › Covert design
- › Various lens options
- › Deep Learning face capture or ANPR (optional)
- › Dual channels on one camera
- › Standalone security site with solar panels and 4G connectivity



Model	DS-2CD642560-10	DS-2CD642560-20	DS-2CD642560-30	DS-2CD642560/F-11	DS-2CD642560/F-21	DS-2CD642560/F-31
Image				 Dual-lens	 Dual-lens	 Dual-lens
Image Sensor	1/2.8" Progressive Scan CMOS	1/2.8" Progressive Scan CMOS	1/2.8" Progressive Scan CMOS	1/2.8" Progressive Scan CMOS	1/2.8" Progressive Scan CMOS	1/2.8" Progressive Scan CMOS
Max. Resolution	1920 × 1080	1920 × 1080	1920 × 1080	1920 × 1080	1920 × 1080	1920 × 1080
Video Compression	Main stream: H.265+ / H.265 / H.264+ / H.264 Sub-stream: H.265 / H.264 / MJPEG Third stream: H.265 / H.264	Main stream: H.265+ / H.265 / H.264+ / H.264 Sub-stream: H.265 / H.264 / MJPEG Third stream: H.265 / H.264	Main stream: H.265+ / H.265 / H.264+ / H.264 Sub-stream: H.265 / H.264 / MJPEG Third stream: H.265 / H.264	Main stream: H.265+ / H.265 / H.264+ / H.264 Sub-stream: H.265 / H.264 / MJPEG	Main stream: H.265+ / H.265 / H.264+ / H.264 Sub-stream: H.265 / H.264 / MJPEG	Main stream: H.265+ / H.265 / H.264+ / H.264 Sub-stream: H.265 / H.264 / MJPEG
Min. Illumination	Color: 0.014 Lux @(F2.0, AGC ON) B/W: 0.0003 Lux @(F2.0, AGC ON)	Color: 0.014 Lux @(F2.0, AGC ON) B/W: 0.0003 Lux @(F2.0, AGC ON)	Color: 0.014 Lux @(F2.0, AGC ON) B/W: 0.0003 Lux @(F2.0, AGC ON)	Color: 0.006 Lux @ (F2.5, AGC ON) B/W: 0.003 Lux @(F2.5, AGC ON)	Color: 0.006 Lux @ (F2.5, AGC ON) B/W: 0.003 Lux @(F2.5, AGC ON)	Color: 0.006 Lux @ (F2.5, AGC ON) B/W: 0.003 Lux @(F2.5, AGC ON)
WDR	120 dB	120 dB	120 dB	120 dB	120 dB	120 dB
Lens	3.7 mm	2.8 or 3.7 mm	2.8, 4.0 or 6.0 mm	3.7 mm	2.8 or 3.7 mm	2, 2.8 or 4 mm
FOV	3.7mm:horizontal FOV 71°	2.8mm:horizontal FOV 88.2° 3.7mm:horizontal FOV 71°	2.8mm:horizontal FOV 104° 4.0mm:horizontal FOV 80° 6.0mm:horizontal FOV 50°	3.7mm:horizontal FOV 75° vertical FOV 41.5°, diagonal FOV 87°	2.8mm:horizontal FOV 94°, vertical FOV 51.5°, diagonal FOV 109° 3.7mm:horizontal FOV 75°, vertical FOV 41.5°, diagonal FOV 87°	2mm:horizontal FOV 132.8°, vertical FOV 77.5°, diagonal FOV 153° 2.8mm:horizontal FOV 110.5°, vertical FOV 60°, diagonal FOV 130° 4mm:horizontal FOV 86°, vertical FOV 45°, diagonal FOV 102°
Max. IR Range	-	-	-	-	-	-
VCA	Line crossing detection, intrusion detection, unattended baggage detection, object removal detection	Line crossing detection, intrusion detection, unattended baggage detection, object removal detection	Line crossing detection, intrusion detection, unattended baggage detection, object removal detection	Channel 1: Deep Learning face capture; line crossing detection, intrusion detection, region entrance, region exiting, unattended baggage, object removal; scene change detection, defocus detection, audio exception detection	Channel 1: Deep Learning face capture; line crossing detection, intrusion detection, region entrance, region exiting, unattended baggage, object removal; scene change detection, defocus detection, audio exception detection	Channel 1: Deep Learning face capture; line crossing detection, intrusion detection, region entrance, region exiting, unattended baggage, object removal; scene change detection, defocus detection, audio exception detection
Frame Rate	50Hz: 25fps (1920 × 1080, 1280 × 960, 1280 × 720) 60Hz: 30fps (1920 × 1080, 1280 × 960, 1280 × 720)	50Hz: 25fps (1920 × 1080, 1280 × 960, 1280 × 720) 60Hz: 30fps (1920 × 1080, 1280 × 960, 1280 × 720)	50Hz: 25fps (1920 × 1080, 1280 × 960, 1280 × 720) 60Hz: 30fps (1920 × 1080, 1280 × 960, 1280 × 720)	50Hz: 25fps (1920 × 1080, 1280 × 960, 1280 × 720) 60Hz: 30fps (1920 × 1080, 1280 × 960, 1280 × 720)	50Hz: 25fps (1920 × 1080, 1280 × 960, 1280 × 720) 60Hz: 30fps (1920 × 1080, 1280 × 960, 1280 × 720)	50Hz: 25fps (1920 × 1080, 1280 × 960, 1280 × 720) 60Hz: 30fps (1920 × 1080, 1280 × 960, 1280 × 720)
Multi-Streaming	3	3	3	2	2	2
Protection Level	-	-	-	-	-	L30: IP66 (2 mm: No)
Angle Adjustment	-	-	-	-	-	-
Operating Temperature	-10 °C to +40 °C (14 °F to +104 °F)	-10 °C to +40 °C (14 °F to +104 °F)	-10 °C to +40 °C (14 °F to +104 °F)	-30 °C to +60 °C (-22 °F to +140 °F)	-30 °C to +60 °C (-22 °F to +140 °F)	-30 °C to +60 °C (-22 °F to +140 °F)
Operating Humidity	5%- 95%	5%- 95%	5%- 95%	≤ 95%	≤ 95%	≤ 95%
Local Storage	128 GB	128 GB	128 GB	128 GB	128 GB	128 GB
Audio I/O	1 in, 1 out	1 in, 1 out	1 in, 1 out	1 in, 1 out	1 in, 1 out	1 in, 1 out
Alarm I/O	1 in, 1 out	1 in, 1 out	1 in, 1 out	2 in, 2 out	2 in, 2 out	2 in, 2 out
Installation	Indoor	Indoor	Indoor	Indoor	Indoor	Indoor
Power Supply	12 VDC ± 20%, two-core terminal block, PoE: (802.3af, class 2)	12 VDC ± 20%, two-core terminal block, PoE: (802.3af, class 2)	12 VDC ± 20%, two-core terminal block, PoE: (802.3af, class 2)	12 VDC + PoE, 8-36 VDC, two-core terminal block, PoE (802.3at, class 4)	12 VDC + PoE, 8-36 VDC, two-core terminal block, PoE (802.3at, class 4)	12 VDC + PoE, 8-36 VDC, two-core terminal block, PoE (802.3at, class 4)

Underwater Camera

Model	DS-2CD2D2160/(M)-DNF	DS-2CD2D1160/(M)-DNF
Image		
Image Sensor	1/2.7" Progressive Scan CMOS	1/2.7" Progressive Scan CMOS
Max. Resolution	1920 × 1080	1280 × 960
Video Compression	H.265 / H.264 / MJPEG	H.265 / H.264 / MJPEG
Min. Illumination	Without /M model: Color: 0.109 Lux @ (F2.5, AGC ON) B/W: 0.022 Lux @ (F2.5, AGC ON) With /M model: Color: 0.069 Lux @ (F2.0, AGC ON) B/W: 0.014 Lux @ (F2.0, AGC ON)	Without /M model: Color: 0.109 Lux @ (F2.5, AGC ON) B/W: 0.022 Lux @ (F2.5, AGC ON) With /M model: Color: 0.069 Lux @ (F2.0, AGC ON) B/W: 0.014 Lux @ (F2.0, AGC ON)
WDR	120 dB	120 dB
Lens	Without /M model: 3.7 mm With /M model: 2.8 mm, 4 mm	Without /M model: 3.7 mm With /M model: 2.8 mm, 4 mm
FOV	Without /M model: 3.7 mm horizontal FOV: 78°, vertical FOV: 43°, diagonal FOV: 90° With/M model: 2.8 mm horizontal FOV: 114°, vertical FOV: 62°, diagonal FOV: 135° 4 mm horizontal FOV: 86°, vertical FOV: 46°, diagonal FOV: 102.5°	Without /M model: 3.7 mm horizontal FOV: 51°, vertical FOV: 38°, diagonal FOV: 64° With /M model: 2.8 mm horizontal FOV: 74°, vertical FOV: 55°, diagonal FOV: 93° 4 mm horizontal FOV: 55°, vertical FOV: 41°, diagonal FOV: 70°
Max. IR Range	-	-
VCA	Line crossing detection, intrusion detection, region entrance detection, region exit detection, unattended baggage detection, object removal detection	Line crossing detection, intrusion detection, region entrance detection, region exit detection, unattended baggage detection, object removal detection
Frame Rate	50Hz: 25fps (1920 × 1080, 1280 × 960, 1280 × 720) 60Hz: 30fps (1920 × 1080, 1280 × 960, 1280 × 720)	50Hz: 25fps (1280 × 960, 1280 × 720) 60Hz: 30fps (1280 × 960, 1280 × 720)
Multi-Streaming	3	3
Protection Level	-	-
Operating Temperature	-30 °C to +60 °C [-22 °F to +140 °F]	-30 °C to +60 °C [-22 °F to +140 °F]
Operating Humidity	≤ 95%	≤ 95%
Local Storage	N/A	N/A
Audio I/O	1 in	1 in
Alarm I/O	N/A	N/A
Installation	Indoor	Indoor
Power Supply	12 VDC ± 20%	12 VDC ± 20%

Model	DS-2XC622460-L	DS-2XC622560-L
Image		
Image Sensor	1/2.8" Progressive Scan CMOS	1/2.8" Progressive Scan CMOS
Max. Resolution	1920 × 1080	1920 × 1080
Video Compression	H.265+ / H.265 / H.264+ / H.264 / MJPEG	H.265 / H.264 / MJPEG
Min. Illumination	Color: 0.003 Lux @ (F2.0, AGC ON) B/W: 0.0003 Lux @ (F2.0, AGC ON), 0 lux with white light	Color: 0.003 Lux @ (F2.0, AGC ON) B/W: 0.0003 Lux @ (F2.0, AGC ON)
WDR	120 dB	120 dB
Lens	2.0, 2.8 or 4.0 mm	2.0, 2.8 or 4.0 mm
FOV	2.0 mm @ F2.2, horizontal FOV 127.6°, vertical FOV 74.5°, diagonal FOV 145.9° 2.8 mm @ F1.6, horizontal FOV 108°, vertical FOV 56.7°, diagonal FOV 121.4° 4 mm @ F1.6, horizontal FOV 82°, vertical FOV 43.8°, diagonal FOV 96.5°	2.0 mm @ F2.0, horizontal FOV 127.6°, vertical FOV 77°, diagonal FOV 151° 2.8 mm @ F1.6, horizontal FOV 103°, vertical FOV 58.5°, diagonal FOV 127° 4 mm @ F1.6, horizontal FOV 82°, vertical FOV 46°, diagonal FOV 103°
Max. White Light Range	10 m	10 m
VCA	Line crossing detection, intrusion detection, region entrance detection, region exiting detection	Line crossing detection, intrusion detection, region entrance detection, region exiting detection
Frame Rate	50Hz: 25fps (1920 × 1080, 1280 × 960, 1280 × 720) 60Hz: 30fps (1920 × 1080, 1280 × 960, 1280 × 720)	50Hz: 25fps (1920 × 1080, 1280 × 960, 1280 × 720) 60Hz: 30fps (1920 × 1080, 1280 × 960, 1280 × 720)
Multi-Streaming	3	3
Protection Level	IP68	IP68
Operating Temperature	-30 °C to +60 °C [-22 °F to +140 °F]	-30 °C to +60 °C [-22 °F to +140 °F]
Operating Humidity	≤ 95%	≤ 95%
Local Storage	128 GB	128 GB
Audio I/O	-	-
Alarm I/O	-	-
Installation	Underwater, cable length 15 m (included)	Underwater, cable length 50 m (included)
Power Supply	36 VDC ± 20%, two-core terminal block, PoE (802.3at, class 3)	36 VDC ± 20%, two-core terminal block, PoE (802.3at, class 3)

Standalone Security Site

Model	DS-2XS6A2560-I/CH20S40
Image	
Image Sensor	1/2.8" Progressive Scan CMOS
Max. Resolution	1920 × 1080
Video Compression	H.265+/H.265/H.264+/H.264/MJPEG
Min. Illumination	Color: 0.004 Lux @ (F1.4, AGC ON), B/W: 0.002 Lux @ (F1.4, AGC ON), 0 Lux with IR on
WDR	120 dB
Lens	2.8, 4 or 8 mm
FOV	2.8 mm @1.4: Horizontal FOV: 107°, vertical FOV: 57°, diagonal FOV: 128° 4 mm @F1.4: Horizontal FOV: 86°, vertical FOV: 46°, diagonal FOV: 102° 8 mm @F1.6: Horizontal FOV: 41°, vertical FOV: 22°, diagonal FOV: 47°
Max. IR Range	30m
VCA	Line crossing detection, intrusion detection, region entrance detection, region exiting detection, Scene change detection
Frame Rate	50Hz: 25fps (1920 × 1080, 1280 × 960, 1280 × 720) 60Hz: 30fps (1920 × 1080, 1280 × 960, 1280 × 720)
Multi-Streaming	3
Protection Level	IP67
Operating Temperature	-5 °C to 55 °C
Operating Humidity	≤ 95%
Local Storage	Built-in 32 GB memory, 256 GB SD Card (optional)
Audio I/O	-
Alarm I/O	-
Installation	Outdoor
Power Supply	12 VDC ± 20%

PTZ Dome Camera

029 Ultra Series

038 Special Series







Ultra Series PTZ Cameras





Great Innovation, Inside and Out





- > H.265+/H.265 codec
- > 4K ultra HD
- > DarkFighterX technology
- > High resolution DarkFighter Deep Learning-based target classification algorithm for Auto-Tracking 3.0 and perimeter protection
- > False alarm reduction
- > Face capture and ANPR
- > Image enhancement including rapid focus, P-Iris, 140 dB WDR, and extended IR
- > High zoom ratio & optical image stabilization (OIS)
- > Supports IK10 & IP67, wiper
- > Supports ONVIF, ISAPI, and CGI
- > Supports Hikvision SDK and third-party management platform







Model	DS-2DF9C245IHS-DLW	DS-2DF9C435IHS-DLW
Image	 DarkFighterX + Deep Learning	 DarkFighterX + Deep Learning
Image Sensor	Dual-sensor, 1/1.8" progressive scan CMOS	Dual-sensor, 1/1.8" progressive scan CMOS
Max. Resolution	1920 × 1080	2688 × 1512
Video Compression	Main Stream: H.265+ / H.265 / H.264+ / H.264	Main Stream: H.265+ / H.265 / H.264+ / H.264
Lens	5.9 to 265 mm, 45x optical	5.9 to 206 mm, 35x optical
Angle of View	Horizontal field of view: 58.9° to 1.7°(wide-tele) Vertical field of view: 35.3° to 0.9°(wide-tele) Diagonal field of view: 65.9° to 1.9° (wide-tele)	Horizontal field of view: 58.9° to 2.2°(wide-tele) Vertical field of view: 35.3° to 1.2°(wide-tele) Diagonal field of view: 65.9° to 2.5° (wide-tele)
Min. Illumination	Color: 0.0005 Lux @(F1.6, AGC ON)	Color: 0.0005 Lux @(F1.6, AGC ON)
WDR	140 dB	140 dB
Max. IR Range	500 m	500 m
VCA	Face Capture, Road Traffic, Auto tracking 3.0 (support tracking specified target types such as human and vehicle), Event tracking Filtering out mistaken alarm caused by target types such as leaf, light, animal, and flag, etc. Intrusion Detection, Line Crossing Detection, Region Entrance Detection, Region Exiting Detection, Unattended Baggage Detection, Object Removal Detection, Audio Exception Detection	Face Capture, Road Traffic, Auto tracking 3.0 (support tracking specified target types such as human and vehicle), Event tracking Filtering out mistaken alarm caused by target types such as leaf, light, animal, and flag, etc. Intrusion Detection, Line Crossing Detection, Region Entrance Detection, Region Exiting Detection, Unattended Baggage Detection, Object Removal Detection, Audio Exception Detection
Frame Rate	50Hz: 25fps (1920 × 1080, 1280 × 960, 1280 × 720) 60Hz: 30fps (1920 × 1080, 1280 × 960, 1280 × 720)	50Hz: 25fps (2688 × 1512, 1920 × 1080, 1280 × 960, 1280 × 720) 60Hz: 30fps (2688 × 1512, 1920 × 1080, 1280 × 960, 1280 × 720)
Streams	3	3
Protection Level	IP 67 Standard. Lightning Protection, Surge Protection and Voltage Transient Protection, ±6kV Line to Gnd, ±3kV Line to Line, IEC61000-4-5	IP 67 Standard. Lightning Protection, Surge Protection and Voltage Transient Protection, ±6kV Line to Gnd, ±3kV Line to Line, IEC61000-4-5
Pan Range	360° endless	360° endless
Tilt Range	From -25° to 90°	From -25° to 90°
Pan Speed	Configurable, from 0.1°/s to 210°/s, Preset Speed: 280°/s	Configurable, from 0.1°/s to 210°/s, Preset Speed: 280°/s
Tilt Speed	Configurable, from 0.1°/s to 150°/s, Preset Speed: 250°/s	Configurable, from 0.1°/s to 150°/s, Preset Speed: 250°/s
Operating Temperature	Outdoor: -40°C to 70°C (-40°F to 158°F)	Outdoor: -40°C to 70°C (-40°F to 158°F)
Humidity	≤ 95%	≤ 95%
Local Storage	Built-in memory card slot, support Micro SD / SDHC / SDXC, up to 256 GB	Built-in memory card slot, support Micro SD / SDHC / SDXC, up to 256 GB
Audio I/O	1/1	1/1
Alarm I/O	7/2	7/2
Power	36 VDC	36 VDC



Model	DS-2DF8225IH-AEL(W)	DS-2DF8225IX-AEL(W)
Image	 DarkFighterX + Deep Learning	 DarkFighter + Deep Learning
Image Sensor	2 × 1/2.8" progressive scan CMOS	1/1.8" progressive scan CMOS
Max. Resolution	1920 × 1080	1920 × 1080
Video Compression	Main Stream: H.265+ / H.265 / H.264+ / H.264	Main Stream: H.265+ / H.265 / H.264+ / H.264
Lens	4.8 to 120 mm, 25x optical	5.9 to 147.5 mm, 25x optical
Angle of View	Horizontal field of view: 58.2° to 3.2° (wide-tele) Vertical field of view: 32.7° to 1.8° (wide-tele) Diagonal field of view: 66.8° to 3.7° (wide-tele)	Horizontal field of view: 59.8° to 3.3° (wide-tele), Vertical field of view: 33.7° to 1.9° (wide-tele), Diagonal field of view: 65° to 3.8° (wide-tele)
Min. Illumination	Color: 0.0004 Lux @(F1.5, AGC ON)	Color: 0.002 Lux @(F1.5, AGC ON)
WDR	120 dB	140 dB
Max. IR Range	200 m	400 m
VCA	Auto tracking 2.0 (support tracking specified target types such as human and vehicle), Event tracking Filtering out mistaken alarm caused by target types such as leaf, light, animal, and flag, etc. Intrusion Detection, Line Crossing Detection, Region Entrance Detection, Region Exiting Detection, Face Detection, Audio Exception Detection	Face Capture, Road Traffic, Auto tracking 2.0 (support tracking specified target types such as human and vehicle), Event tracking Filtering out mistaken alarm caused by target types such as leaf, light, animal, and flag, etc. Intrusion Detection, Line Crossing Detection, Region Entrance Detection, Region Exiting Detection, Unattended Baggage Detection, Object Removal Detection, Audio Exception Detection
Frame Rate	50Hz: 25fps (1920 × 1080, 1280 × 960, 1280 × 720) 60Hz: 30fps (1920 × 1080, 1280 × 960, 1280 × 720)	50Hz: 25fps (1920 × 1080, 1280 × 960, 1280 × 720) 60Hz: 30fps (1920 × 1080, 1280 × 960, 1280 × 720)
Streams	3	3
Protection Level	IP67 Standard. Lightning protection, surge protection and voltage transient protection meets IEC61000-4-2-2/3/4/5/6	Lightning Protection, Surge Protection and Voltage Transient Protection, ±6kV Line to Gnd, ±3kV Line to Line, IEC61000-4-5, IP67 Standard, IK10(without wiper)
Pan Range	360° endless	360° endless
Tilt Range	From -20° to 90°	From -20° to 90°
Pan Speed	Configurable, from 0.1°/s to 210°/s, Preset Speed: 280°/s	Configurable, from 0.1°/s to 210°/s, Preset Speed: 280°/s
Tilt Speed	Configurable, from 0.1°/s to 150°/s, Preset Speed: 250°/s	Configurable, from 0.1°/s to 150°/s, Preset Speed: 250°/s
Operating Temperature	Temperature: -40°C to 70°C (-40°F to 158°F)	Temperature: -40°C to 70°C (-40°F to 158°F)
Humidity	≤ 95%	≤ 95%
Local Storage	Built-in memory card slot, support Micro SD / SDHC / SDXC, up to 256 GB	Built-in memory card slot, support Micro SD / SDHC / SDXC, up to 256 GB
Audio I/O	1/1	1/1
Alarm I/O	7/2	7/2
Power	Without wiper: 24 VAC (Max. 68 W) , Hi-PoE (Max. 60 W) With Wiper: 24 VAC (Max. 70 W) , Hi-PoE (Max. 60 W)	24 VAC (Max. 60 W) , Hi-PoE (Max. 50 W)





Model	DS-2DF8242IX-AEL(W)	DS-2DF8425IX-AEL(W)	DS-2DF8442IXS-AEL(W)	DS-2DF8242IXS-AEL(W)	DS-2DF8A442IXS-AEL
Image	 NEW DarkFighter + Deep Learning	 HOT DarkFighter + Deep Learning	 NEW DarkFighter + Deep Learning	 NEW DarkFighter + Deep Learning	 NEW DarkFighter + Deep Learning
Image Sensor	1/1.8" progressive scan CMOS	1/1.8" progressive scan CMOS	1/1.8" progressive scan CMOS	1/1.8" progressive scan CMOS	1/1.8" progressive scan CMOS
Max. Resolution	1920 × 1080	2560 × 1440	2560 × 1440	1920 × 1080	2560 × 1440
Video Compression	Main Stream: H.265+ / H.265 / H.264+ / H.264	Main Stream: H.265+ / H.265 / H.264+ / H.264	Main Stream: H.265+ / H.265 / H.264+ / H.264	Main Stream: H.265+ / H.265 / H.264+ / H.264	Main Stream: H.265+ / H.265 / H.264+ / H.264
Lens	6.0 to 252 mm, 42x optical	5.9 to 147.5 mm, 25x optical	6.0 to 252 mm, 42x optical	6.0 to 252 mm, 42x optical	6.0 to 252 mm, 42x optical
Angle of View	Horizontal field of view: 56.6° to 1.7° (wide-tele), Vertical field of view: 33.7° to 0.9° (wide-tele), Diagonal field of view: 63.4° to 1.9° (wide-tele)	Horizontal field of view: 59.8° to 3.3° (wide-tele), Vertical field of view: 33.7° to 1.9° (wide-tele), Diagonal field of view: 65° to 3.8° (wide-tele)	Horizontal field of view: 56.6° to 1.7° (wide-tele), Vertical field of view: 33.7° to 0.9° (wide-tele), Diagonal field of view: 63.4° to 1.9° (wide-tele)	Horizontal field of view: 56.6° to 1.7° (wide-tele), Vertical field of view: 33.7° to 0.9° (wide-tele), Diagonal field of view: 63.4° to 1.9° (wide-tele)	Horizontal field of view: 56.6° to 1.7° (wide-tele), Vertical field of view: 33.7° to 0.9° (wide-tele), Diagonal field of view: 63.4° to 1.9° (wide-tele)
Min. Illumination	Color: 0.002 Lux @(F1.2, AGC ON)	Color: 0.002 Lux @(F1.5, AGC ON)	Color: 0.002 Lux @(F1.2, AGC ON)	Color: 0.002 Lux @(F1.2, AGC ON)	Color: 0.002 Lux @(F1.2, AGC ON)
WDR	140 dB	140 dB	140 dB	140 dB	140 dB
Max. IR Range	400 m	500 m	500 m	500 m	500 m
VCA	Face Capture, Road Traffic, Auto tracking 2.0 (support tracking specified target types such as human and vehicle), Event tracking Filtering out mistaken alarm caused by target types such as leaf, light, animal, and flag, etc. Intrusion Detection, Line Crossing Detection, Region Entrance Detection, Region Exiting Detection, Unattended Baggage Detection, Object Removal Detection, Audio Exception Detection	Face Capture, Road Traffic, Auto tracking 2.0 (support tracking specified target types such as human and vehicle), Event tracking Filtering out mistaken alarm caused by target types such as leaf, light, animal, and flag, etc. Intrusion Detection, Line Crossing Detection, Region Entrance Detection, Region Exiting Detection, Unattended Baggage Detection, Object Removal Detection, Audio Exception Detection	Face Capture, Road Traffic, Auto tracking 3.0 (support tracking specified target types such as human and vehicle), Event tracking Filtering out mistaken alarm caused by target types such as leaf, light, animal, and flag, etc. Intrusion Detection, Line Crossing Detection, Region Entrance Detection, Region Exiting Detection, Unattended Baggage Detection, Object Removal Detection, Audio Exception Detection	Face Capture, Road Traffic, Auto tracking 2.0 (support tracking specified target types such as human and vehicle), Event tracking Filtering out mistaken alarm caused by target types such as leaf, light, animal, and flag, etc. Intrusion Detection, Line Crossing Detection, Region Entrance Detection, Region Exiting Detection, Unattended Baggage Detection, Object Removal Detection, Audio Exception Detection	Face Capture, Road Traffic, Auto tracking 2.0 (support tracking specified target types such as human and vehicle), Event tracking Filtering out mistaken alarm caused by target types such as leaf, light, animal, and flag, etc. Intrusion Detection, Line Crossing Detection, Region Entrance Detection, Region Exiting Detection, Unattended Baggage Detection, Object Removal Detection, Audio Exception Detection
Frame Rate	50Hz: 25fps (1920 × 1080, 1280 × 960, 1280 × 720) 60Hz: 30fps (1920 × 1080, 1280 × 960, 1280 × 720)	50Hz: 25fps (2560 × 1440, 1920 × 1080, 1280 × 960, 1280 × 720) 60Hz: 30fps (2560 × 1440, 1920 × 1080, 1280 × 960, 1280 × 720)	50Hz: 25 fps (2560 × 1440, 1920 × 1080, 1280 × 960, 1280 × 720) 60Hz: 30 fps (2560 × 1440, 1920 × 1080, 1280 × 960, 1280 × 720)	50Hz: 25fps (1920 × 1080, 1280 × 960, 1280 × 720) 60Hz: 30fps (1920 × 1080, 1280 × 960, 1280 × 720)	50Hz: 25fps (2560 × 1440, 1920 × 1080, 1280 × 960, 1280 × 720); 50fps (2560 × 1440, 1920 × 1080, 1280 × 960, 1280 × 720); 60Hz: 30fps (2560 × 1440, 1920 × 1080, 1280 × 960, 1280 × 720); 60fps (2560 × 1440, 1920 × 1080, 1280 × 960, 1280 × 720);
Streams	3	3	3	3	3
Protection Level	Lightning Protection, Surge Protection and Voltage Transient Protection, ±6kV Line to Gnd, ±3kV Line to Line, IEC61000-4-5, IP67 Standard, IK10(without wiper)	Lightning Protection, Surge Protection and Voltage Transient Protection, ±6kV Line to Gnd, ±3kV Line to Line, IEC61000-4-5, IP67 Standard, IK10(without wiper)	Lightning Protection, Surge Protection and Voltage Transient Protection, ±6kV Line to Gnd, ±3kV Line to Line, IEC61000-4-5, IP67 Standard, IK10(without wiper)	Lightning Protection, Surge Protection and Voltage Transient Protection, ±6kV Line to Gnd, ±3kV Line to Line, IEC61000-4-5, IP67 Standard	Lightning Protection, Surge Protection and Voltage Transient Protection, ±6kV Line to Gnd, ±3kV Line to Line, IEC61000-4-5, IP67 Standard, IK10
Pan Range	360° endless	360° endless	360° endless	360° endless	360° endless
Tilt Range	From -20° to 90°	From -20° to 90°	From -20° to 90°	From -20° to 90°	From -20° to 90° (Auto-flip)
Pan Speed	Configurable, from 0.1°/s to 210°/s, Preset Speed: 280°/s	Configurable, from 0.1°/s to 210°/s, Preset Speed: 280°/s	Configurable, from 0.1°/s to 210°/s, Preset Speed: 280°/s	Configurable, from 0.1°/s to 210°/s, Preset Speed: 280°/s	Configurable, from 0.1°/s to 210°/s, Preset Speed: 280°/s
Tilt Speed	Configurable, from 0.1°/s to 150°/s, Preset Speed: 250°/s	Configurable, from 0.1°/s to 150°/s, Preset Speed: 250°/s	Configurable, from 0.1°/s to 150°/s, Preset Speed: 250°/s	Configurable, from 0.1°/s to 150°/s, Preset Speed: 250°/s	Configurable, from 0.1°/s to 150°/s, Preset Speed: 250°/s
Operating Temperature	Temperature: -40°C to 70°C (-40°F to 158°F)	Temperature: -40°C to 70°C (-40°F to 158°F)	Temperature: -40°C to 70°C (-40°F to 158°F)	Temperature: -40°C to 70°C (-40°F to 158°F)	Temperature: -40°C to 70°C (-40°F to 158°F)
Humidity	≤ 95%	≤ 95%	≤ 95%	≤ 95%	≤ 95%
Local Storage	Built-in memory card slot, support Micro SD/SDHC/SDXC, up to 256 GB	Built-in memory card slot, support Micro SD/SDHC/SDXC, up to 256 GB	Built-in memory card slot, support Micro SD/SDHC/SDXC, up to 256 GB	Built-in memory card slot, support Micro SD/SDHC/SDXC, up to 256 GB	Built-in memory card slot, support Micro SD/SDHC/SDXC, up to 256 GB
Audio I/O	1/1	1/1	1/1	1/1	1/1
Alarm I/O	7/2	7/2	7/2	7/2	7/2
Power	24 VAC (Max. 60 W) , Hi-PoE (Max. 50 W)	24 VAC (Max. 60 W) , Hi-PoE (Max. 50 W)	24 VAC (Max. 60 W) , Hi-PoE (Max. 50 W)	24 VAC (Max. 60 W) , Hi-PoE (Max. 50 W)	24 VAC (Max. 60 W) , Hi-PoE (Max. 50 W)



Model	DS-2DF8C260I5XS-AELW	DS-2DF8C448I5XS-AELW	DS-2DF8C848I5XS-AELW	DS-2DF8C842I5XS-AEL
Image	 DarkFighter + Deep Learning	 DarkFighter + Deep Learning	 DarkFighter + Deep Learning	 DarkFighter + Deep Learning
Image Sensor	1/1.8" progressive scan CMOS	1/1.8" progressive scan CMOS	1/1.8" progressive scan CMOS	1/1.2" progressive scan CMOS
Max. Resolution	1920 × 1080	2560 × 1440	3840 × 2160	3840 × 2160
Video Compression	Main Stream: H.265+ / H.265 / H.264+ / H.264	Main Stream: H.265+ / H.265 / H.264+ / H.264	Main Stream: H.265+ / H.265 / H.264+ / H.264	Main Stream: H.265+ / H.265 / H.264+ / H.264
Lens	6.0 to 360 mm, 60 × Optical	6.0 to 288 mm, 48 × Optical	6.0 to 288 mm, 48 × Optical	7.5 mm to 315 mm, 42 × Optical
Angle of View	Horizontal field of view: 60.0° to 2.0° (wide-tele), Vertical field of view: 35.8° to 1.2° (wide-tele), Diagonal field of view: 67.0° to 2.4° (wide-tele)	Horizontal field of view: 60.0° to 2.0° (wide-tele), Vertical field of view: 35.8° to 1.2° (wide-tele), Diagonal field of view: 67.0° to 2.4° (wide-tele)	Horizontal field of view: 60.0° to 2.0° (wide-tele), Vertical field of view: 35.8° to 1.2° (wide-tele), Diagonal field of view: 67.0° to 2.4° (wide-tele)	Horizontal field of view: 60.4° to 1.7° (wide-tele), Vertical field of view: 36.2° to 0.9° (wide-tele), Diagonal field of view: 67.8° to 2.2° (wide-tele)
Min. Illumination	Color: 0.002 Lux @ (F1.5, AGC ON), B/W: 0.0002 Lux @ (F1.5, AGC ON)	Color: 0.002 Lux @ (F1.5, AGC ON), B/W: 0.0002 Lux @ (F1.5, AGC ON)	Color: 0.002 Lux @ (F1.5, AGC ON), B/W: 0.0002 Lux @ (F1.5, AGC ON)	Color: 0.002 Lux @ (F1.6, AGC ON), B/W: 0.0002 Lux @ (F1.6, AGC ON), 0 Lux with IR
WDR	140 dB	140 dB	120 dB	120 dB
Max. IR Range	500 m	500 m	500 m	500 m
VCA	Multi-target-type Detection (support face and human body capture, and output linked information), Face capture, Road Traffic, People Arming, Vehicle Arming, Auto tracking 3.0 (support tracking specified target types such as human and vehicle), Event tracking Filtering out mistaken alarm caused by target types such as leaf, light, animal, and flag, etc. Intrusion Detection, Line Crossing Detection, Region Entrance Detection, Region Exiting Detection, Unattended Baggage Detection, Object Removal Detection, Audio Exception Detection	Multi-target-type Detection (support face and human body capture, and output linked information), Face capture, Road Traffic, People Arming, Vehicle Arming, Auto tracking 3.0 (support tracking specified target types such as human and vehicle), Event tracking Filtering out mistaken alarm caused by target types such as leaf, light, animal, and flag, etc. Intrusion Detection, Line Crossing Detection, Region Entrance Detection, Region Exiting Detection, Unattended Baggage Detection, Object Removal Detection, Audio Exception Detection	Multi-target-type Detection (support face and human body capture, and output linked information), Face capture, Road Traffic, People Arming, Vehicle Arming, Auto tracking 3.0 (support tracking specified target types such as human and vehicle), Event tracking Filtering out mistaken alarm caused by target types such as leaf, light, animal, and flag, etc. Intrusion Detection, Line Crossing Detection, Region Entrance Detection, Region Exiting Detection, Unattended Baggage Detection, Object Removal Detection, Audio Exception Detection	Multi-target-type Detection (support face and human body capture, and output linked information), Face capture, Road Traffic, People Arming, Vehicle Arming, Auto tracking 3.0 (support tracking specified target types such as human and vehicle), Event tracking Filtering out mistaken alarm caused by target types such as leaf, light, animal, and flag, etc. Intrusion Detection, Line Crossing Detection, Region Entrance Detection, Region Exiting Detection, Unattended Baggage Detection, Object Removal Detection, Audio Exception Detection
Frame Rate	50 Hz: 25 fps (1920 × 1080, 1280 × 960, 1280 × 720); 60 Hz: 30 fps (1920 × 1080, 1280 × 960, 1280 × 720)	50 Hz: 25 fps (2560 × 1440, 1920 × 1080, 1280 × 960, 1280 × 720); 60 Hz: 30 fps (2560 × 1440, 1920 × 1080, 1280 × 960, 1280 × 720)	Main Stream 50 Hz: 25 fps (3840 × 2160, 2560 × 1440, 1920 × 1080, 1280 × 960, 1280 × 720); 60 Hz: 30 fps (3840 × 2160, 2560 × 1440, 1920 × 1080, 1280 × 960, 1280 × 720)	50 Hz: 25 fps (3840 × 2160, 2560 × 1440, 1920 × 1080, 1280 × 960, 1280 × 720); 60 Hz: 30 fps (3840 × 2160, 2560 × 1440, 1920 × 1080, 1280 × 960, 1280 × 720)
Streams	3	3	3	3
Protection Level	IP67 Standard, 6000V Lightning Protection, Surge Protection and Voltage Transient Protection, IK10 (excluding glass window)	IP67 Standard, 6000V Lightning Protection, Surge Protection and Voltage Transient Protection, IK10 (excluding glass window)	IP67 Standard, 6000V Lightning Protection, Surge Protection and Voltage Transient Protection, IK10 (excluding glass window)	Lightning Protection, Surge Protection and Voltage Transient Protection, ±6kV Line to Gnd, ±3kV Line to Line, IEC61000-4-5, IP67 Standard, IK10 (excluding glass window)
Pan Range	360° endless	360° endless	360° endless	360° endless
Tilt Range	From -20° to 90°	From -20° to 90°	From -20° to 90°	From -20° to 90°
Pan Speed	Configurable, from 0.1°/s to 210°/s, Preset Speed: 280°/s	Configurable, from 0.1°/s to 210°/s, Preset Speed: 280°/s	Configurable, from 0.1°/s to 210°/s, Preset Speed: 280°/s	Configurable, from 0.1°/s to 210°/s, Preset Speed: 280°/s
Tilt Speed	Configurable, from 0.1°/s to 150°/s, Preset Speed: 250°/s	Configurable, from 0.1°/s to 150°/s, Preset Speed: 250°/s	Configurable, from 0.1°/s to 150°/s, Preset Speed: 250°/s	Configurable, from 0.1°/s to 150°/s, Preset Speed: 250°/s
Operating Temperature	Outdoor: -40°C to 70°C (-40°F to 158°F)	Outdoor: -40°C to 70°C (-40°F to 158°F)	Outdoor: -40°C to 70°C (-40°F to 158°F)	Outdoor: -40°C to 70°C (-40°F to 158°F)
Humidity	≤ 95%	≤ 95%	≤ 95%	≤ 95%
Local Storage	support microSD/microSDHC/microSDXC cards, up to 256 GB	support microSD/microSDHC/microSDXC cards, up to 256 GB	support microSD/microSDHC/microSDXC cards, up to 256 GB	support microSD/microSDHC/microSDXC cards, up to 256 GB
Audio I/O	1/1	1/1	1/1	1/1
Alarm I/O	7/2	7/2	7/2	7/2
Power	24 VAC (Max. 62 W, including max. 12 W for IR and max. 8 W for heater), PoE 802.3 bt (Max. 51 W, including max. 12 W for IR and max. 8 W for heater)	24 VAC (Max. 62 W, including max. 12 W for IR and max. 8 W for heater), PoE 802.3 bt (Max. 51 W, including max. 12 W for IR and max. 8 W for heater)	24 VAC (Max. 62 W, including max. 12 W for IR and max. 8 W for heater), PoE 802.3 bt (Max. 51 W, including max. 12 W for IR and max. 8 W for heater)	24 VAC (Max. 62 W, including max. 12 W for IR and max. 8 W for heater), PoE 802.3 bt (Max. 51 W, including max. 12 W for IR and max. 8 W for heater)



Model	DS-2DF8C842IXS-AEL	DS-2DF8C825IXS-AEL	DS-2DF8A842IXS-AEL
Image	 NEW DarkFighter + Deep Learning	 NEW DarkFighter + Deep Learning	 NEW DarkFighter + Deep Learning
Image Sensor	1/1.2" progressive scan CMOS	1/1.2" progressive scan CMOS	1/1.8" progressive scan CMOS
Max. Resolution	3840 × 2160	3840 × 2160	3840 × 2160
Video Compression	Main Stream: H.265+ / H.265 / H.264+ / H.264	Main Stream: H.265+ / H.265 / H.264+ / H.264	Main Stream: H.265+ / H.265 / H.264+ / H.264
Lens	7.5 mm to 315 mm, 42 × Optical	7.5 mm to 187.5 mm, 25 × Optical	6 mm to 252 mm, 42 × Optical
Angle of View	Horizontal field of view: 60.4° to 1.7° (wide-tele), Vertical field of view: 36.2° to 0.9° (wide-tele), Diagonal field of view: 67.8° to 2.2° (wide-tele)	Horizontal field of view: 60.4° to 3.7° (wide-tele), Vertical field of view: 36.2° to 2.1° (wide-tele), Diagonal field of view: 67.8° to 4.3° (wide-tele)	Horizontal field of view: 56.6° to 1.7° (wide-tele), Vertical field of view: 33.7° to 0.9° (wide-tele), Diagonal field of view: 63.4° to 1.9° (wide-tele)
Min. Illumination	Color: 0.002 Lux @(F1.6, AGC ON), B/W: 0.0002 Lux @(F1.6, AGC ON), 0 Lux with IR	Color: 0.002 Lux @(F1.6, AGC ON), B/W: 0.0002 Lux @(F1.6, AGC ON), 0 Lux with IR	Color: 0.005 Lux @(F1.2, AGC ON), B/W: 0.0005 Lux @(F1.2, AGC ON), 0 Lux with IR
WDR	120 dB	120 dB	120 dB
Max. IR Range	500 m	500 m	500 m
VCA	Multi-target-type Detection (support face and human body capture, and output linked information), Face capture, Road Traffic, People Arming, Vehicle Arming, Auto tracking 3.0 (support tracking specified target types such as human and vehicle), Event tracking Filtering out mistaken alarm caused by target types such as leaf, light, animal, and flag, etc. Intrusion Detection, Line Crossing Detection, Region Entrance Detection, Region Exiting Detection, Unattended Baggage Detection, Object Removal Detection, Audio Exception Detection	Multi-target-type Detection (support face and human body capture, and output linked information), Face capture, Road Traffic, People Arming, Vehicle Arming, Auto tracking 3.0 (support tracking specified target types such as human and vehicle), Event tracking Filtering out mistaken alarm caused by target types such as leaf, light, animal, and flag, etc. Intrusion Detection, Line Crossing Detection, Region Entrance Detection, Region Exiting Detection, Unattended Baggage Detection, Object Removal Detection, Audio Exception Detection	Multi-target-type Detection (support face and human body capture, and output linked information), Face capture, Road Traffic, People Arming, Vehicle Arming, Auto tracking 3.0 (support tracking specified target types such as human and vehicle), Event tracking Filtering out mistaken alarm caused by target types such as leaf, light, animal, and flag, etc. Intrusion Detection, Line Crossing Detection, Region Entrance Detection, Region Exiting Detection, Unattended Baggage Detection, Object Removal Detection, Audio Exception Detection
Frame Rate	50 Hz: 25 fps (3840 × 2160, 2560 × 1440, 1920 × 1080, 1280 × 960, 1280 × 720); 60 Hz: 30 fps (3840 × 2160, 2560 × 1440, 1920 × 1080, 1280 × 960, 1280 × 720),	50 Hz: 25 fps (3840 × 2160, 2560 × 1440, 1920 × 1080, 1280 × 960, 1280 × 720); 60 Hz: 30 fps (3840 × 2160, 2560 × 1440, 1920 × 1080, 1280 × 960, 1280 × 720),	50 Hz: 25 fps (3840 × 2160, 2560 × 1440, 1920 × 1080, 1280 × 960, 1280 × 720); 60 Hz: 30 fps (3840 × 2160, 2560 × 1440, 1920 × 1080, 1280 × 960, 1280 × 720)
Streams	3	3	3
Protection Level	Lightning Protection, Surge Protection and Voltage Transient Protection, ±6kV Line to Gnd, ±3kV Line to Line, IEC61000-4-5, IP67 Standard, IK10 (excluding glass window)	Lightning Protection, Surge Protection and Voltage Transient Protection, ±6kV Line to Gnd, ±3kV Line to Line, IEC61000-4-5, IP67 Standard, IK10 (excluding glass window)	IP67, Lightning Protection, Surge Protection and Voltage Transient Protection, ±6kV Line to Gnd, ±3kV Line to Line, IEC61000-4-5, IK10
Pan Range	360° endless	360° endless	360° endless
Tilt Range	From -20° to 90°	From -20° to 90°	From -20° to 90°
Pan Speed	Configurable, from 0.1°/s to 210°/s, Preset Speed: 280°/s	Configurable, from 0.1°/s to 210°/s, Preset Speed: 280°/s	Configurable, from 0.1°/s to 210°/s, Preset Speed: 280°/s
Tilt Speed	Configurable, from 0.1°/s to 150°/s, Preset Speed: 250°/s	Configurable, from 0.1°/s to 150°/s, Preset Speed: 250°/s	Configurable, from 0.1°/s to 150°/s, Preset Speed: 250°/s
Operating Temperature	Outdoor: -40°C to 70°C (-40°F to 158°F)	Outdoor: -40°C to 70°C (-40°F to 158°F)	Outdoor: -40°C to 70°C (-40°F to 158°F)
Humidity	≤ 95%	≤ 95%	≤ 95%
Local Storage	support microSD/microSDHC/microSDXC cards, up to 256 GB	support microSD/microSDHC/microSDXC cards, up to 256 GB	support microSD/microSDHC/microSDXC cards, up to 256 GB
Audio I/O	1/1	1/1	1/1
Alarm I/O	7/2	7/2	7/2
Power	24 VAC (Max. 60 W, including max. 15 W for IR and max. 8 W for heater), PoE 802.3 bt (Max. 51 W, including max. 15 W for IR and max. 8 W for heater)	24 VAC (Max. 60 W, including max. 15 W for IR and max. 8 W for heater), PoE 802.3 bt (Max. 51 W, including max. 15 W for IR and max. 8 W for heater)	24 VAC (Max. 60 W, including max. 18 W for laser and max. 6 W for heater), Hi-PoE (Max. 50 W, including max. 18 W for laser and max. 6 W for heater)





Model	DS-2DF7225IX-AEL(W)	DS-2DF7232IX-AEL(W)
Image	 DarkFighter + Deep Learning	 DarkFighter + Deep Learning
Image Sensor	1/2.8" progressive scan CMOS	1/2.8" progressive scan CMOS
Resolution	1920 × 1080	1920 × 1080
Video Compression	Main Stream: H.265+ / H.265 / H.264+ / H.264	Main Stream: H.265+ / H.265 / H.264+ / H.264
Lens	4.8 to 120 mm, 25x optical	4.8 to 153 mm, 32x optical
Angle of View	Horizontal field of view: 58.4° to 2.7° (wide-tele) Vertical field of view: 33.8° to 1.5° (wide-tele) Diagonal field of view: 65.6° to 3.1° (wide-tele)	Horizontal field of view: 58.4° to 2.14° (wide-tele) Vertical field of view: 33.8° to 1.2° (wide-tele) Diagonal field of view: 65.6° to 2.46° (wide-tele)
Min. Illumination	Color: 0.002 Lux @(F1.2, AGC ON)	Color: 0.002 Lux @(F1.2, AGC ON)
WDR	120 dB	120 dB
Max. IR Range	300 m	300 m
VCA	Face Capture, Road Traffic, Auto tracking 2.0 (support tracking specified target types such as human and vehicle), Event tracking Filtering out mistaken alarm caused by target types such as leaf, light, animal, and flag, etc. Intrusion Detection, Line Crossing Detection, Region Entrance Detection, Region Exiting Detection, Unattended Baggage Detection, Object Removal Detection, Audio Exception Detection	Face Capture, Road Traffic, Auto tracking 2.0 (support tracking specified target types such as human and vehicle), Event tracking Filtering out mistaken alarm caused by target types such as leaf, light, animal, and flag, etc. Intrusion Detection, Line Crossing Detection, Region Entrance Detection, Region Exiting Detection, Unattended Baggage Detection, Object Removal Detection, Audio Exception Detection
Frame Rate	50Hz: 50fps (1920 × 1080, 1280 × 960, 1280 × 720) 60Hz: 60fps (1920 × 1080, 1280 × 960, 1280 × 720)	50Hz: 50fps (1920 × 1080, 1280 × 960, 1280 × 720) 60Hz: 60fps (1920 × 1080, 1280 × 960, 1280 × 720)
Streams	3	3
Protection Level	IP66 Standard	IP66 Standard
Pan Range	360° endless	360° endless
Tilt Range	From -15° to 90°	From -15° to 90°
Pan Speed	Configurable, from 0.1°/s to 210°/s, Preset Speed: 280°/s	Configurable, from 0.1°/s to 210°/s, Preset Speed: 280°/s
Tilt Speed	Configurable, from 0.1°/s to 150°/s, Preset Speed: 250°/s	Configurable, from 0.1°/s to 150°/s, Preset Speed: 250°/s
Operating Temperature	Temperature: -40°C to 70°C (-40°F to 158°F)	Temperature: -40°C to 70°C (-40°F to 158°F)
Humidity	≤ 95%	≤ 95%
Local Storage	Built-in memory card slot, support Micro SD / SDHC / SDXC, up to 256 GB	Built-in memory card slot, support Micro SD / SDHC / SDXC, up to 256 GB
Audio I/O	1/1	1/1
Alarm I/O	7/2	7/2
Power	24 VAC (Max. 60 W) , Hi-PoE (Max. 50 W)	24 VAC (Max. 60 W) , Hi-PoE (Max. 50 W)

Model	DS-2DF6A225X-AEL	DS-2DF6A236X-AEL
Image	 DarkFighter + Deep Learning	 DarkFighter + Deep Learning
Image Sensor	1/1.8" progressive scan CMOS	1/1.8" progressive scan CMOS
Resolution	1920 × 1080	1920 × 1080
Video Compression	Main Stream: H.265+ / H.265 / H.264+ / H.264	Main Stream: H.265+ / H.265 / H.264+ / H.264
Lens	5.9 to 147.5 mm, 25x optical zoom	6.0 to 216 mm, 36x optical zoom
Angle of View	Horizontal field of view: 59.8° to 3.3° (wide-tele), Vertical field of view: 33.7° to 1.9° (wide-tele), Diagonal field of view: 65° to 3.8° (wide-tele)	Horizontal field of view: 56.6° to 2.0° (wide-tele), Vertical field of view: 33.7° to 1.2° (wide-tele), Diagonal field of view: 63.4° to 2.3° (wide-tele)
Min. Illumination	Color: 0.002 lux @ (F1.5, AGC ON)	Color: 0.002 lux @ (F1.2, AGC ON)
WDR	140 dB	140 dB
Max. IR Range	-	-
VCA	Face Capture, Road Traffic, Auto tracking 2.0 (support tracking specified target types such as human and vehicle), Event tracking Filtering out mistaken alarm caused by target types such as leaf, light, animal, and flag, etc. Intrusion Detection, Line Crossing Detection, Region Entrance Detection, Region Exiting Detection, Unattended Baggage Detection, Object Removal Detection, Audio Exception Detection	Face Capture, Road Traffic, Auto tracking 2.0 (support tracking specified target types such as human and vehicle), Event tracking Filtering out mistaken alarm caused by target types such as leaf, light, animal, and flag, etc. Intrusion Detection, Line Crossing Detection, Region Entrance Detection, Region Exiting Detection, Unattended Baggage Detection, Object Removal Detection, Audio Exception Detection
Frame Rate	50Hz: 50fps (1920 × 1080, 1280 × 960, 1280 × 720) 60Hz: 60fps (1920 × 1080, 1280 × 960, 1280 × 720)	50Hz: 50fps (1920 × 1080, 1280 × 960, 1280 × 720) 60Hz: 60fps (1920 × 1080, 1280 × 960, 1280 × 720)
Streams	3	3
Protection Level	Lightning Protection, Surge Protection and Voltage Transient Protection, ±6 kV Line to Gnd, ±3kV Line to Line, IEC61000-4-5, IP67 Standard, IK10	Lightning Protection, Surge Protection and Voltage Transient Protection, ±6 kV Line to Gnd, ±3 kV Line to Line, IEC61000-4-5, IP67 Standard, IK10
Pan Range	360° endless	360° endless
Tilt Range	From -20° to 90° (auto flip)	From -20° to 90° (auto flip)
Pan Speed	Configurable, from 0.1°/s to 300°/s, preset speed: 540°/s	Configurable, from 0.1°/s to 300°/s, preset speed: 540°/s
Tilt Speed	Configurable, from 0.1°/s to 240°/s, Preset Speed: 400°/s	Configurable, from 0.1°/s to 240°/s, Preset Speed: 400°/s
Operating Temperature	Temperature: -40°C to 70°C (-40°F to 158°F)	Temperature: -40°C to 70°C (-40°F to 158°F)
Humidity	≤ 90%	≤ 90%
Local Storage	Built-in memory card slot, support Micro SD / SDHC / SDXC, up to 256 GB; NAS (NPS, SMB / CIFS), ANR	Built-in memory card slot, support Micro SD / SDHC / SDXC, up to 256 GB; NAS (NFS, SMB / CIFS), ANR
Audio I/O	1/1	1/1
Alarm I/O	7/2	7/2
Power	24 VAC (Max. 60 W) , Hi-PoE (Max. 50 W)	24 VAC (Max. 60 W) , Hi-PoE (Max. 50 W)

Model	DS-2DF6A425X-AEL	DS-2DF6A436X-AEL	DS-2DF6A825X-AEL	DS-2DF6A836X-AEL
Image	 DarkFighter + Deep Learning	 DarkFighter + Deep Learning	 Deep Learning 4K	 Deep Learning 4K
Image Sensor	1/1.8" progressive scan CMOS	1/1.8" progressive scan CMOS	2/3" progressive scan CMOS	2/3" progressive scan CMOS
Resolution	2560 × 1440	2560 × 1440	4096 × 2160	4096 × 2160
Video Compression	Main Stream: H.265+ / H.265 / H.264+ / H.264	Main Stream: H.265+ / H.265 / H.264+ / H.264	Main Stream: H.265+ / H.265 / H.264+ / H.264	Main Stream: H.265+ / H.265 / H.264+ / H.264
Lens	5.9 to 147.5 mm, 25x optical zoom	6.0 to 216 mm, 36x optical zoom	7.5 to 187.5 mm, 25x optical zoom	7.5 to 270 mm, 36x optical zoom
Angle of View	Horizontal field of view: 59.8° to 3.3° (wide-tele), Vertical field of view: 33.7° to 1.9° (wide-tele), Diagonal field of view: 65° to 3.8° (wide-tele)	Horizontal field of view: 56.6° to 2.0° (wide-tele), Vertical field of view: 33.7° to 1.2° (wide-tele), Diagonal field of view: 63.4° to 2.3° (wide-tele)	Horizontal field of view: 56.1° to 3.0° (Wide-Tele) Vertical field of view: 33.4° to 1.7° (Wide-Tele) Diagonal field of view: 62.9° to 3.4° (Wide-Tele)	Horizontal field of view: 56.1° to 2.0° (Wide-Tele) Vertical field of view: 33.4° to 1.1° (Wide-Tele) Diagonal field of view: 62.9° to 2.3° (Wide-Tele)
Min. Illumination	Color: 0.002 lux @ (F1.5, AGC ON)	Color: 0.002 lux @ (F1.2, AGC ON)	Color: 0.005 lux @ (F1.5, AGC ON)	Color: 0.005 lux @ (F1.5, AGC ON)
WDR	140 dB	140 dB	DWDR	DWDR
Max. IR Range	-	-	-	-
VCA	Face Capture, Road Traffic, Auto tracking 2.0 (support tracking specified target types such as human and vehicle), Event tracking Filtering out mistaken alarm caused by target types such as leaf, light, animal, and flag, etc. Intrusion Detection, Line Crossing Detection, Region Entrance Detection, Region Exiting Detection, Unattended Baggage Detection, Object Removal Detection, Audio Exception Detection	Face Capture, Road Traffic, Auto tracking 2.0 (support tracking specified target types such as human and vehicle), Event tracking Filtering out mistaken alarm caused by target types such as leaf, light, animal, and flag, etc. Intrusion Detection, Line Crossing Detection, Region Entrance Detection, Region Exiting Detection, Unattended Baggage Detection, Object Removal Detection, Audio Exception Detection	Face Capture, Auto tracking 2.0 (support tracking specified target types such as human and vehicle), Event tracking Filtering out mistaken alarm caused by target types such as leaf, light, animal, and flag, etc. Intrusion Detection, Line Crossing Detection, Region Entrance Detection, Region Exiting Detection, Unattended Baggage Detection, Object Removal Detection, Audio Exception Detection	Face Capture, Auto tracking 2.0 (support tracking specified target types such as human and vehicle), Event tracking Filtering out mistaken alarm caused by target types such as leaf, light, animal, and flag, etc. Intrusion Detection, Line Crossing Detection, Region Entrance Detection, Region Exiting Detection, Unattended Baggage Detection, Object Removal Detection, Audio Exception Detection
Frame Rate	50Hz: 25fps (2560 × 1440, 1920×1080, 1280 × 960, 1280×720) 60Hz: 30fps (2560 × 1440, 1920×1080, 1280 × 960, 1280×720)	50Hz: 25fps (2560 × 1440, 1920×1080, 1280 × 960, 1280×720) 60Hz: 30fps (2560 × 1440, 1920×1080, 1280 × 960, 1280×720)	50Hz: 25fps (4096 × 2160, 3840 × 2160, 3072 × 1728, 2560 × 1440, 2048 × 1536, 1920 × 1080, 1280 × 960, 1280 × 720) 60Hz: 30fps (4096 × 2160, 3840 × 2160, 3072 × 1728, 2560 × 1440, 2048 × 1536, 1920 × 1080, 1280 × 960, 1280 × 720)	50Hz: 25fps (4096 × 2160, 3840 × 2160, 3072 × 1728, 2560 × 1440, 2048 × 1536, 1920 × 1080, 1280 × 960, 1280 × 720) 60Hz: 30fps (4096 × 2160, 3840 × 2160, 3072 × 1728, 2560 × 1440, 2048 × 1536, 1920 × 1080, 1280 × 960, 1280 × 720)
Streams	3	3	3	3
Protection Level	Lightning Protection, Surge Protection and Voltage Transient Protection, ±6 kV Line to Gnd, ±3kV Line to Line, IEC61000-4-5, IP67 Standard, IK10	Lightning Protection, Surge Protection and Voltage Transient Protection, ±6kV Line to Gnd, ±3kV Line to Line, IEC61000-4-5, IP67 Standard, IK10	IP67 Standard, IK10, 6000V Lightning Protection, Surge Protection and Voltage Transient Protection	IP67 Standard, IK10, 6000V Lightning Protection, Surge Protection and Voltage Transient Protection
Pan Range	360° endless	360° endless	360° endless	360° endless
Tilt Range	From -20° to 90° (auto flip)	From -20° to 90° (auto flip)	From -20° to 90° (auto flip)	From -20° to 90° (auto flip)
Pan Speed	Configurable, from 0.1°/s to 300°/s, preset speed: 540°/s	Configurable, from 0.1°/s to 300°/s, preset speed: 540°/s	Configurable, from 0.1°/s to 350°/s, Preset Speed: 540°/s	Configurable, from 0.1°/s to 350°/s, preset speed: 540°/s
Tilt Speed	Configurable, from 0.1°/s to 240°/s, Preset Speed: 400°/s	Configurable, from 0.1°/s to 240°/s, Preset Speed: 400°/s	Configurable, from 0.1°/s to 240°/s, Preset Speed: 400°/s	Configurable, from 0.1°/s to 240°/s, Preset Speed: 400°/s
Operating Temperature	Temperature: -40°C to 70°C (-40°F to 158°F)	Temperature: -40°C to 70°C (-40°F to 158°F)	-40°C to 70°C (-40°F to 158°F)	-40°C to 70°C (-40°F to 158°F)
Humidity	≤ 90%	≤ 90%	≤ 95%	≤ 95%
Local Storage	Built-in memory card slot, support Micro SD/SDHC/SDXC, up to 256 GB; NAS (NFS, SMB/ CIFS), ANR	Built-in memory card slot, support Micro SD/SDHC/SDXC, up to 256 GB; NAS (NFS, SMB/ CIFS), ANR	Built-in memory card slot, support Micro SD/SDHC/SDXC, up to 256 GB; NAS (NFS, SMB/ CIFS), ANR	Built-in memory card slot, support Micro SD/SDHC/SDXC, up to 256 GB; NAS (NFS, SMB/CIFS), ANR
Audio I/O	1/1	1/1	1/1	1/1
Alarm I/O	7/2	7/2	7/2	7/2
Power	24 VAC (Max. 60 W) , Hi-PoE (Max. 50 W)	24 VAC (Max. 60 W) , Hi-PoE (Max. 50 W)	24 VAC (Max. 60 W) , Hi-PoE (Max. 50 W)	24 VAC (Max. 60 W) , Hi-PoE (Max. 50 W)

Model	DS-2DF5225X-AEL(3)	DS-2DF5232X-AEL(3)
Image	 DarkFighter + Deep Learning	 DarkFighter + Deep Learning
Image Sensor	1/2.8" progressive scan CMOS	1/2.8" progressive scan CMOS
Resolution	1920 × 1080	1920 × 1080
Video Compression	Main Stream: H.265+ / H.265 / H.264+ / H.264	Main Stream: H.265+ / H.265 / H.264+ / H.264
Lens	4.8 to 120 mm, 25x optical	4.8 to 153 mm, 32x optical
Angle of View	Horizontal field of view: 58.4° to 2.7° (wide-tele) Vertical field of view: 33.8° to 1.5° (wide-tele) Diagonal field of view: 65.6° to 3.1° (wide-tele)	Horizontal field of view: 58.4° to 2.14° (wide-tele) Vertical field of view: 33.8° to 1.2° (wide-tele) Diagonal field of view: 65.6° to 2.46° (wide-tele)
Min. Illumination	Color: 0.002 lux @ (F1.2, AGC ON)	Color: 0.002 lux @ (F1.2, AGC ON)
WDR	120 dB	120 dB
Max. IR Range	-	-
VCA	Face Capture, Road Traffic, Auto tracking 2.0 (support tracking specified target types such as human and vehicle), Event tracking Filtering out mistaken alarm caused by target types such as leaf, light, animal, and flag, etc. Intrusion Detection, Line Crossing Detection, Region Entrance Detection, Region Exiting Detection, Unattended Baggage Detection, Object Removal Detection, Audio Exception Detection	Face Capture, Road Traffic, Auto tracking 2.0 (support tracking specified target types such as human and vehicle), Event tracking Filtering out mistaken alarm caused by target types such as leaf, light, animal, and flag, etc. Intrusion Detection, Line Crossing Detection, Region Entrance Detection, Region Exiting Detection, Unattended Baggage Detection, Object Removal Detection, Audio Exception Detection
Frame Rate	50Hz: 50fps (1920 × 1080, 1280 × 960, 1280 × 720) 60Hz: 60fps (1920 × 1080, 1280 × 960, 1280 × 720)	50Hz: 50fps (1920 × 1080, 1280 × 960, 1280 × 720) 60Hz: 60fps (1920 × 1080, 1280 × 960, 1280 × 720)
Streams	3	3
Protection Level	IP66 Standard (Outdoor), IK10	IP66 Standard (Outdoor), IK10
Pan Range	360° endless	360° endless
Tilt Range	From -15° to 90° (Auto flip)	From -15° to 90° (Auto flip)
Pan Speed	Configurable, from 0.1°/s to 300°/s, Preset Speed: 540°/s	Configurable, from 0.1°/s to 300°/s, Preset Speed: 540°/s
Tilt Speed	Configurable, from 0.1°/s to 240°/s, Preset Speed: 400°/s	Configurable, from 0.1°/s to 240°/s, Preset Speed: 400°/s
Operating Temperature	Outdoor model: -40°C to 70°C (-40°F to 158°F) Indoor model: -10°C to 50°C (14°F to 122°F)	Outdoor model: -40°C to 70°C (-40°F to 158°F) Indoor model: -10°C to 50°C (14°F to 122°F)
Humidity	≤ 95%	≤ 95%
Local Storage	Built-in memory card slot, support Micro SD/SDHC/SDXC, up to 256 GB; NAS (NFS, SMB/ CIFS), ANR	Built-in memory card slot, support Micro SD/SDHC/SDXC, up to 256 GB; NAS (NFS, SMB/ CIFS), ANR
Audio I/O	1/1	1/1
Alarm I/O	7/2	7/2
Power	Outdoor model: 24 VAC (Max. 60 W), Hi-PoE (Max. 50 W) Indoor model: 24 VAC (Max. 25 W), Hi-PoE (Max. 25 W)	Outdoor model: 24 VAC (Max. 60 W), Hi-PoE (Max. 50 W) Indoor model: 24 VAC (Max. 25 W), Hi-PoE (Max. 25 W)

Model	DS-2DE7225IW-AE	DS-2DE7232IW-AE
Image		 HOT
Image Sensor	1/2.8" progressive scan CMOS	1/2.8" progressive scan CMOS
Resolution	1920 × 1080	1920 × 1080
Video Compression	Main Stream: H.265+ / H.265 / H.264+ / H.264	Main Stream: H.265+ / H.265 / H.264+ / H.264
Lens	4.8 to 120 mm, 25x optical	4.8 to 153 mm, 32x optical
Angle of View	Horizontal field of view: 57.6° to 2.5° (Wide-Tele) Vertical field of view: 34.4° to 1.4° (Wide-Tele) Diagonal field of view: 64.5° to 2.9° (Wide-Tele)	Horizontal field of view: 55.6° to 2.04° (Wide-Tele) Vertical field of view: 32.4° to 1.14° (Wide-Tele) Diagonal field of view: 63° to 2.34° (Wide-Tele)
Min. Illumination	Color: 0.005 lux @ (F1.6, AGC ON)	Color: 0.005 lux @ (F1.6, AGC ON)
WDR	120 dB	120 dB
Max. IR Range	20 0 m	150 m
VCA	Face Detection, Intrusion Detection, Line Crossing Detection, Region Entrance Detection, Region Exiting Detection, Object Removal Detection, Unattended Baggage Detection, Audio Exception Detection	Face Detection, Intrusion Detection, Line Crossing Detection, Region Entrance Detection, Region Exiting Detection, Object Removal Detection, Unattended Baggage Detection, Audio Exception Detection
Frame Rate	50Hz: 50fps (1920 × 1080, 1280 × 960, 1280 × 720) 60Hz: 60fps (1920 × 1080, 1280 × 960, 1280 × 720)	50Hz: 50fps (1920 × 1080, 1280 × 960, 1280 × 720) 60Hz: 60fps (1920 × 1080, 1280 × 960, 1280 × 720)
Streams	3	3
Protection Level	IP66 Standard, IK10 [excluding glass window], 4000V Lightning Protection, Surge Protection and Voltage Transient Protection	IP66 Standard, IK10 [excluding glass window], 4000V Lightning Protection, Surge Protection and Voltage Transient Protection
Pan Range	360° endless	360° endless
Tilt Range	From -15° to 90° (Auto-flip)	From -15° to 90° (Auto-flip)
Pan Speed	Configurable, from 0.1°/s to 160°/s, Preset Speed: 240°/s	Configurable, from 0.1°/s to 160°/s, Preset Speed: 240°/s
Tilt Speed	Configurable, from 0.1°/s to 120°/s, Preset Speed: 200°/s	Configurable, from 0.1°/s to 120°/s, Preset Speed: 200°/s
Operating Temperature	-30°C to 65°C (-22°F to 149°F)	-30°C to 65°C (-22°F to 149°F)
Humidity	≤ 90%	≤ 90%
Local Storage	Built-in memory card slot, support Micro SD / SDHC / SDXC, up to 256 GB	Built-in memory card slot, support Micro SD / SDHC / SDXC, up to 256 GB
Audio I/O	1/1	1/1
Alarm I/O	2/1	2/1
Power	24 VAC & Hi-PoE, Max.: 40 W (IR Max.19 W)	24 VAC & Hi-PoE, Max.: 40 W (IR Max.19 W)

Model	DS-2DE7A232MW-AE(S5)	DS-2DE7A245IX-AE/S1	DS-2DE7425IW-AE	DS-2DE7530IW-AE	DS-2DE7432IW-AE
Image	 NEW	 NEW			
Image Sensor	1/2.8" progressive scan CMOS	1/2.8" progressive scan CMOS	1/2.8" progressive scan CMOS	1/1.9" progressive scan CMOS	1/2.8" progressive scan CMOS
Resolution	1920 × 1080	1920 × 1080	2560 × 1440	2592 × 1944	2560 × 1440
Video Compression	Main Stream: H.265+ / H.265 / H.264+ / H.264	Main Stream: H.265+ / H.265 / H.264+ / H.264	Main Stream: H.265+ / H.265 / H.264+ / H.264	Main Stream: H.265+ / H.265 / H.264+ / H.264	Main Stream: H.265+ / H.265 / H.264+ / H.264
Lens	4.8 to 153 mm, 32x optical	4 to 180 mm, 45x optical	4.8 to 120 mm, 25x optical	5.9 to 177 mm, 30x optical	4.8 mm to 153 mm, 32 × optical
Angle of View	Horizontal field of view: 58.4° to 2.14° (wide-tele), Vertical field of view: 33.8° to 1.2° (wide-tele), Diagonal field of view: 65.6° to 2.46° (wide-tele)	Horizontal field of view: 70.3° to 1.8° (Wide-Tele) Vertical field of view: 42.2° to 1.0° (Wide-Tele) Diagonal field of view: 78.3° to 2.1° (Wide-Tele)	Horizontal field of view: 55° to 2.4° (Wide-Tele) Vertical field of view: 33° to 1.4° (Wide-Tele) Diagonal field of view: 61.5 to 2.8° (Wide-Tele)	51.3° to 2.7° (Wide-Tele)	Horizontal field of view: 54.3° to 2° (wide-tele), Vertical field of view: 31.8° to 1.1° (wide-tele), Diagonal field of view: 61.1° to 2.3° (wide-tele)
Min. Illumination	Color: 0.001 Lux @(F1.2, AGC ON)	Color: 0.005 lux @(F1.6, AGC ON)	Color: 0.005 lux @(F1.6, AGC ON)	Color: 0.005 lux @(F1.5, AGC ON)	Color: 0.005 Lux @(F1.2, AGC ON), B/W: 0.001 Lux @(F1.2, AGC ON), 0 Lux with IR
WDR	120 dB	120 dB	120 dB	DWDR	120 dB
Max. IR Range	200 m	200 m	150 m	150 m	200 m
VCA	Face Capture, Intrusion Detection, Line Crossing Detection, Region Entrance Detection, Region Exiting Detection, Object Removal Detection, Unattended Baggage Detection, Audio Exception Detection	Face Detection, Intrusion Detection, Line Crossing Detection, Region Entrance Detection, Region Exiting Detection, Object Removal Detection, Unattended Baggage Detection, Audio Exception Detection	Face Detection, Intrusion Detection, Line Crossing Detection, Region Entrance Detection, Region Exiting Detection, Object Removal Detection, Unattended Baggage Detection, Audio Exception Detection	Face Detection, Intrusion Detection, Line Crossing Detection, Region Entrance Detection, Region Exiting Detection, Audio Exception Detection	Face Capture, Intrusion detection, line crossing detection, region entrance detection, region exiting detection, unattended baggage detection, object removal detection, audio exception
Frame Rate	50Hz: 25fps (1920 × 1080, 1280 × 960, 1280 × 720) 60Hz: 30fps (1920 × 1080, 1280 × 960, 1280 × 720)	50Hz: 25fps (1920 × 1080, 1280 × 960, 1280 × 720) 50fps (1920 × 1080, 1280 × 960, 1280 × 720) 60Hz: 30fps (1920 × 1080, 1280 × 960, 1280 × 720) 60fps (1920 × 1080, 1280 × 960, 1280 × 720)	50Hz: 25fps (2560 × 1440, 2048 × 1536, 1920 × 1080, 1280 × 960, 1280 × 720) 50fps (1920 × 1080, 1280 × 960, 1280 × 720) 60Hz: 30fps (2560 × 1440, 2048 × 1536, 1920 × 1080, 1280 × 960, 1280 × 720) 60fps (1920 × 1080, 1280 × 960, 1280 × 720)	50Hz: 25fps (2592 × 1944, 2560 × 1440, 2048 × 1536, 1920 × 1080, 1280 × 960, 1280 × 720) 50fps (1920 × 1080, 1280 × 960, 1280 × 720) 60Hz: 30fps (2592 × 1944, 2560 × 1440, 2048 × 1536, 1920 × 1080, 1280 × 960, 1280 × 720) 60fps (1920 × 1080, 1280 × 960, 1280 × 720)	50Hz: 25fps (2560 × 1440, 1920 × 1080, 1280 × 960, 1280 × 720) 60Hz: 30fps (2560 × 1440, 1920 × 1080, 1280 × 960, 1280 × 720)
Streams	3	3	3	3	3
Protection Level	IP66, IK10 (excluding glass window), 4000V Lightning Protection, Surge Protection and Voltage Transient Protection	IP66 Standard, 4000V Lightning Protection, Surge Protection and Voltage Transient Protection	IP66 Standard, 4000V Lightning Protection, Surge Protection and Voltage Transient Protection	IP66 Standard, 4000V Lightning Protection, Surge Protection and Voltage Transient Protection	IP66 Standard, IK10 (excluding glass window), 6000V Lightning Protection, Surge Protection and Voltage Transient Protection
Pan Range	360° endless	360° endless	360° endless	360° endless	360° endless
Tilt Range	From -15° to 90° (Auto-flip)	From -15° to 90° (Auto-flip)	From -15° to 90° (Auto Flip)	From -15° to 90° (Auto Flip)	From -15° to 90° (Auto Flip)
Pan Speed	Configurable, from 0.1°/s to 160°/s, Preset Speed: 240°/s	Configurable, from 0.1°/s to 160°/s, Preset Speed: 240°/s	Configurable, from 0.1°/s to 160°/s, Preset Speed: 240°/s	Configurable, from 0.1°/s to 160°/s, Preset Speed: 240°/s	Configurable, from 0.1°/s to 160°/s, Preset Speed: 240°/s
Tilt Speed	Configurable, from 0.1°/s to 120°/s, Preset Speed: 200°/s	Configurable, from 0.1°/s to 120°/s, Preset Speed: 200°/s	Configurable, from 0.1°/s to 120°/s, Preset Speed: 200°/s	Configurable, from 0.1°/s to 120°/s, Preset Speed: 200°/s	Configurable, from 0.1°/s to 120°/s, Preset Speed: 200°/s
Operating Temperature	-30°C to 65°C (-22°F to 149°F)	-30°C to 65°C (-22°F to 149°F)	-30°C to 65°C (-22°F to 149°F)	-30°C to 65°C (-22°F to 149°F)	-30°C to 65°C (-22°F to 149°F)
Humidity	≤ 90%	≤ 90%	≤ 90%	≤ 90%	≤ 90%
Local Storage	Built-in memory card slot, support Micro SD / SDHC / SDXC, up to 256 GB	Built-in memory card slot, support Micro SD / SDHC / SDXC, up to 256 GB; NAS (NFS, SMB/CIFS), ANR	Built-in memory card slot, support Micro SD / SDHC / SDXC, up to 256 GB	Built-in memory card slot, support Micro SD / SDHC / SDXC, up to 128 GB	support microSD/microSDHC/microSDXC cards, up to 256 GB
Audio I/O	1/1	1/1	1/1	1/1	1/1
Alarm I/O	2/1	2/1	2/1	2/1	2/1
Power	24 VAC & Hi-PoE, Max.: 42 W (IR Max. 18 W)	24 VAC & Hi-PoE, Max.: 40 W (IR Max.16 W)	24 VAC & Hi-PoE, Max.: 40 W (IR Max.16 W)	24 VAC & Hi-PoE, Max.: 40 W (IR Max.19 W)	24 VAC & Hi-PoE, Max. 42 W, including max. 10 W for heater and max. 18 W for supplement light







Special Series PTZ Cameras







Great Innovation, Inside and Out

- › Up to 1920 x 1080 resolution
- › H.265+ / H.265 codec
- › DarkFighter Technology
- › More zoom ratio options – 20x / 23x / 30x / 36x / 50x
- › Supplemental light options – IR (up to 200 m in distance), Laser (up to 1,000 m in distance)
- › Supports IP66, wiper
- › Supports ONVIF, ISAPI, and CGI
- › Supports Hikvision SDK and third-party management platform



Positioning Systems

Model	DS-2DY9225IH-A	DS-2DY9250IAX-A(S1)	DS-2DY9250IX-A(S1)	DS-2DY9250X-A(S1)	DS-2DY9236I8X-A	DS-2DY9236IX-A
Image	 DarkFighter⁺	 NEW	 NEW	 NEW	 DarkFighter⁺	 DarkFighter⁺
Image Sensor	2 × 1/2.8" progressive scan CMOS	1/2.8" progressive scan CMOS	1/2.8" progressive scan CMOS	1/2.8" progressive scan CMOS	1/1.8" progressive scan CMOS	1/1.8" progressive scan CMOS
Resolution	1920 × 1080	1920 × 1080	1920 × 1080	1920 × 1080	1920 × 1080	1920 × 1080
Video Compression	Main Stream: H.265+ / H.265 / H.264+ / H.264	Main Stream: H.265+ / H.265 / H.264+ / H.264	Main Stream: H.265+ / H.265 / H.264+ / H.264	Main Stream: H.265+ / H.265 / H.264+ / H.264	Main Stream: H.265+ / H.265 / H.264+ / H.264	Main Stream: H.265+ / H.265 / H.264+ / H.264
Lens	4.8 to 120 mm, 25x optical	6.6 to 330 mm, 50x optical	6.6 to 330 mm, 50x optical	6.6 to 330 mm, 50x optical	6.0 to 216 mm, 36x optical	6.0 to 216 mm, 36x optical
Angle of View	Horizontal field of view: 58.2° to 3.2° (wide-tele) Vertical field of view: 32.7° to 1.8° (wide-tele) Diagonal field of view: 66.8° to 3.7° (wide-tele)	Horizontal field of view: 41.3° to 1.1° (wide-tele) Vertical field of view: 23.6° to 0.6° (wide-tele) Diagonal field of view: 47.4° to 1.3° (wide-tele)	Horizontal field of view: 41.3° to 1.1° (wide-tele) Vertical field of view: 23.6° to 0.6° (wide-tele) Diagonal field of view: 47.4° to 1.3° (wide-tele)	Horizontal field of view: 41.3° to 1.1° (wide-tele) Vertical field of view: 23.6° to 0.6° (wide-tele) Diagonal field of view: 47.4° to 1.3° (wide-tele)	Horizontal field of view: 56.6° to 2.0° (wide-tele), Vertical field of view: 33.7° to 1.2° (wide-tele), Diagonal field of view: 63.4° to 2.3° (wide-tele)	Horizontal field of view: 56.6° to 2.0° (wide-tele), Vertical field of view: 33.7° to 1.2° (wide-tele), Diagonal field of view: 63.4° to 2.3° (wide-tele)
Min. Illumination	Color: 0.001 lux @ (F1.5, AGC ON)	Color: 0.05 lux @ (F1.8, AGC ON)	Color: 0.05 lux @ (F1.8, AGC ON)	Color: 0.05 lux @ (F1.8, AGC ON)	Color: 0.002 lux @ (F1.3, AGC ON)	Color: 0.002 lux @ (F1.3, AGC ON)
WDR	120 dB	120 dB	120 dB	120 dB	140 dB	140 dB
Max. IR Range	200 m	1000 m	500 m	-	800 m	400 m
VCA	Face Detection, Audio Exception Detection, Intrusion Detection, Line Crossing Detection, Region Entrance Detection, Region Exiting Detection	Intrusion Detection, Line Crossing Detection, Region Entrance Detection, Region Exiting Detection, Unattended Baggage detection, Object Removal Detection	Intrusion Detection, Line Crossing Detection, Region Entrance Detection, Region Exiting Detection, Unattended Baggage detection, Object Removal Detection	Intrusion Detection, Line Crossing Detection, Region Entrance Detection, Region Exiting Detection, Unattended Baggage detection, Object Removal Detection	Face Capture, Road Traffic, Auto tracking 2.0 (support tracking specified target types such as human and vehicle), Event tracking Filtering out mistaken alarm caused by target types such as leaf, light, animal, and flag, etc. Intrusion Detection, Line Crossing Detection, Region Entrance Detection, Region Exiting Detection, Unattended Baggage Detection, Object Removal Detection, Audio Exception Detection	Face Capture, Road Traffic, Auto tracking 2.0 (support tracking specified target types such as human and vehicle), Event tracking Filtering out mistaken alarm caused by target types such as leaf, light, animal, and flag, etc. Intrusion Detection, Line Crossing Detection, Region Entrance Detection, Region Exiting Detection, Unattended Baggage Detection, Object Removal Detection, Audio Exception Detection
Frame Rate	50Hz: 25fps (1920 × 1080, 1280 × 960, 1280 × 720) 60Hz: 30fps (1920 × 1080, 1280 × 960, 1280 × 720)	50Hz: 50fps (1920 × 1080, 1280 × 960, 1280 × 720) 60Hz: 60fps (1920 × 1080, 1280 × 960, 1280 × 720)	50Hz: 50fps (1920 × 1080, 1280 × 960, 1280 × 720) 60Hz: 60fps (1920 × 1080, 1280 × 960, 1280 × 720)	50Hz: 50fps (1920 × 1080, 1280 × 960, 1280 × 720) 60Hz: 60fps (1920 × 1080, 1280 × 960, 1280 × 720)	50Hz: 25 fps (1920 × 1080, 1280 × 960, 1280 × 720) 60Hz: 30 fps (1920 × 1080, 1280 × 960, 1280 × 720)	50Hz: 25 fps (1920 × 1080, 1280 × 960, 1280 × 720) 60Hz: 30 fps (1920 × 1080, 1280 × 960, 1280 × 720)
Streams	3	3	3	3	3	3
Protection Level	IP66 Standard; 6000V Lightning Protection, Surge Protection and Voltage Transient Protection	IP66 Standard; 6000V Lightning Protection, Surge Protection and Voltage Transient Protection	IP66 Standard; 6000V Lightning Protection, Surge Protection and Voltage Transient Protection	IP66 Standard; 6000V Lightning Protection, Surge Protection and Voltage Transient Protection	IP66 Standard; 6000V Lightning Protection, Surge Protection and Voltage Transient Protection	IP66 Standard; 6000V Lightning Protection, Surge Protection and Voltage Transient Protection
Pan Range	360° endless	360° endless	360° endless	360° endless	360° endless	360° endless
Tilt Range	From -90° to 40°	From -90° to 40°	From -90° to 40°	From -90° to 40°	From -90° to 40°	From -90° to 40°
Pan Speed	Configurable, from 0.1°/s to 100°/s, Preset Speed: 100°/s	Configurable, from 0.1°/s to 100°/s, Preset Speed: 100°/s	Configurable, from 0.1°/s to 100°/s, Preset Speed: 100°/s	Configurable, from 0.1°/s to 100°/s, Preset Speed: 100°/s	Configurable, from 0.1°/s to 100°/s, Preset Speed: 100°/s	Configurable, from 0.1°/s to 100°/s, Preset Speed: 100°/s
Tilt Speed	Configurable, from 0.1°/s to 40°/s, Preset Speed: 40°/s	Configurable, from 0.1°/s to 50°/s, Preset Speed: 100°/s	Configurable, from 0.1°/s to 50°/s, Preset Speed: 100°/s	Configurable, from 0.1°/s to 50°/s, Preset Speed: 100°/s	Configurable, from 0.1°/s to 50°/s, Preset Speed: 100°/s	Configurable, from 0.1°/s to 50°/s, Preset Speed: 100°/s
Operating Temperature	-40°C to 70°C (-40°F to 158°F)	-40°C to 70°C (-40°F to 158°F)	-40°C to 70°C (-40°F to 158°F)	-40°C to 70°C (-40°F to 158°F)	-40°C to 70°C (-40°F to 158°F)	-40°C to 70°C (-40°F to 158°F)
Humidity	≤ 95%	≤ 95%	≤ 95%	≤ 95%	≤ 95%	≤ 95%
Local Storage	Built-in memory card slot, support Micro SD/SDHC/SDXC, up to 256 GB; NAS (NFS, SMB/ CIFS), ANR	Built-in memory card slot, support Micro SD/SDHC/SDXC, up to 256 GB; NAS (NFS, SMB/ CIFS), ANR	Built-in memory card slot, support Micro SD/SDHC/SDXC, up to 256 GB; NAS (NFS, SMB/ CIFS), ANR	Built-in memory card slot, support Micro SD/SDHC/SDXC, up to 256 GB; NAS (NFS, SMB/ CIFS), ANR	Built-in memory card slot, support Micro SD/SDHC/SDXC, up to 256 GB; NAS (NFS, SMB/ CIFS), ANR	Built-in memory card slot, support Micro SD/SDHC/SDXC, up to 256 GB; NAS (NFS, SMB/ CIFS), ANR
Audio I/O	1/1	1/1	1/1	1/1	1/1	1/1
Alarm I/O	7/2	7/2	7/2	7/2	7/2	7/2
Power	24 VAC (Max. 120 W)	24 VAC (Max. 120 W)	24 VAC (Max. 120 W)	24 VAC (Max. 90 W)	24 VAC (Max. 120 W)	24 VAC (Max. 120 W)

Model	DS-2DY9236X-A	DS-2DY7236IW-A	DS-2DY7236W-A	DS-2DY5223IW-AE	DS-2DY3220IW-DE(4)	DS-2DY3320IW-DE(4)
Image	 DarkFighter	 DarkFighter	 DarkFighter	 DarkFighter		
Image Sensor	1/1.8" progressive scan CMOS	1/1.8" progressive scan CMOS	1/1.8" progressive scan CMOS	1/1.9" progressive scan CMOS	1/2.8" progressive scan CMOS	1/2.8" progressive scan CMOS
Resolution	1920 × 1080	1920 × 1080	1920 × 1080	1920 × 1080	1920 × 1080	2048 × 1536
Video Compression	Main Stream: H.265+ / H.265 / H.264+ / H.264	Main Stream: H.265+ / H.265 / H.264+ / H.264	Main Stream: H.265+ / H.265 / H.264+ / H.264	Main Stream: H.265+ / H.265 / H.264+ / H.264	Main Stream: H.265+ / H.265 / H.264+ / H.264	Main Stream: H.265+ / H.265 / H.264+ / H.264
Lens	6.0 to 216 mm, 36x optical	5.7 to 205 mm, 36x optical	5.7 to 205 mm, 36x optical	5.9 to 135.7 mm, 23x optical	4.7 to 94 mm, 20x optical	4.7 to 94 mm, 20x optical
Angle of View	Horizontal field of view: 56.6° to 2.0° (wide-tele), Vertical field of view: 33.7° to 1.2° (wide-tele), Diagonal field of view: 63.4° to 2.3° (wide-tele)	Horizontal field of view: 59.8° to 2.0° (Wide-Tele) Vertical field of view: 33.6° to 1.1° (Wide-Tele) Diagonal field of view: 68.6° to 2.3° (Wide-Tele)	Horizontal field of view: 59.8° to 2.0° (Wide-Tele) Vertical field of view: 33.6° to 1.1° (Wide-Tele) Diagonal field of view: 68.6° to 2.3° (Wide-Tele)	Horizontal field of view: 59.8° to 3.0° (Wide-Tele)	Horizontal field of view: 61.4° to 2.9° (Wide-Tele)	Horizontal field of view: 58.3° to 3.2° (Wide-Tele)
Min. Illumination	Color: 0.002 lux @ (F1.3, AGC ON)	Color: 0.002 lux @ (F1.5, AGC ON)	Color: 0.002 lux @ (F1.5, AGC ON)	Color: 0.002 lux @ (F1.5, AGC ON)	Color: 0.05 lux @ (F1.6, AGC ON)	Color: 0.05 lux @ (F1.6, AGC ON)
WDR	140 dB	120 dB	120 dB	120 dB	DWDR	DWDR
Max. IR Range	-	150 m	-	150 m	100 m	100 m
VCA	Face Capture, Road Traffic, Auto tracking 2.0 (support tracking specified target types such as human and vehicle), Event tracking Filtering out mistaken alarm caused by target types such as leaf, light, animal, and flag, etc. Intrusion Detection, Line Crossing Detection, Region Entrance Detection, Region Exiting Detection, Unattended Baggage Detection, Object Removal Detection, Audio Exception Detection	Intrusion Detection, Line Crossing Detection, Audio Exception Detection	Intrusion Detection, Line Crossing Detection, Audio Exception Detection	Face detection, Intrusion detection, Line crossing detection, Audio exception detection, Region entrance detection, Region exiting detection	Intrusion Detection, Line Crossing Detection, Region Exiting Detection, Region Entrance Detection	Intrusion Detection, Line Crossing Detection, Region Exiting Detection, Region Entrance Detection
Frame Rate	50Hz: 25 fps (1920 × 1080, 1280 × 960, 1280 × 720) 60Hz: 30 fps (1920 × 1080, 1280 × 960, 1280 × 720)	50Hz: 25fps (1920 × 1080, 1280 × 960, 1280 × 720) 50fps (1920 × 1080, 1280 × 960, 1280 × 720) 60Hz: 30fps (1920 × 1080, 1280 × 960, 1280 × 720) 60fps (1920 × 1080, 1280 × 960, 1280 × 720)	50Hz: 25fps (1920 × 1080, 1280 × 960, 1280 × 720) 50fps (1920 × 1080, 1280 × 960, 1280 × 720) 60Hz: 30fps (1920 × 1080, 1280 × 960, 1280 × 720) 60fps (1920 × 1080, 1280 × 960, 1280 × 720)	50Hz:25fps(1920×1080), 25fps(1280×720) 60Hz:30fps(1920×1080), 30fps(1280×720)	50Hz: 25fps (1920 × 1080, 1280 × 960, 1280 × 720) 50fps (1920 × 1080, 1280 × 960, 1280 × 720) 60Hz: 30fps (1920 × 1080, 1280 × 960, 1280 × 720) 60fps (1920 × 1080, 1280 × 960, 1280 × 720)	50Hz: 25fps (2048 × 1536, 1920 × 1080, 1280 × 960, 1280 × 720) 50fps (1920 × 1080, 1280 × 960, 1280 × 720) 60Hz: 30fps (2048 × 1536, 1920 × 1080, 1280 × 960, 1280 × 720) 60fps (1920 × 1080, 1280 × 960, 1280 × 720)
Streams	3	3	3	2	3	3
Protection Level	IP66 Standard; 6000V Lightning Protection, Surge Protection and Voltage Transient Protection	IP66 Standard; TVS 6000V Lightning Protection, Surge Protection and Voltage Transient Protection	IP66 Standard; TVS 6000V Lightning Protection, Surge Protection and Voltage Transient Protection	IP66 standard, TVS 6,000V lightning protection, surge protection and voltage transient protection	IP66 Standard; 6000V Lightning Protection, Surge Protection and Voltage Transient Protection	IP66 Standard; 6000V Lightning Protection, Surge Protection and Voltage Transient Protection
Pan Range	360° endless	360° endless	360° endless	360° endless	360° endless	360° endless
Tilt Range	From -90° to 40°	From -40° to 90°	From -40° to 90°	From 90° to -90° (Auto Flip)	From -40° to 30°	From -40° to 30°
Pan Speed	Configurable, from 0.1°/s to 100°/s, Preset Speed: 100°/s	Configurable, from 0.1°/s to 150°/s, Preset Speed: 150°/s	Configurable, from 0.1°/s to 150°/s, Preset Speed: 150°/s	Configurable, from 0.1°/s to 200°/s	Configurable, from 0.1°/s to 50°/s, Preset speed 50°/s	Configurable, from 0.1°/s to 50°/s, Preset speed 50°/s
Tilt Speed	Configurable, from 0.1°/s to 50°/s, Preset Speed: 100°/s	Configurable, from 0.1°/s to 100°/s, Preset Speed: 100°/s	Configurable, from 0.1°/s to 100°/s, Preset Speed: 100°/s	Configurable, from 0.1°/s to 50°/s	Configurable, from 0.1°/s to 25°/s, Preset speed 25°/s	Configurable, from 0.1°/s to 25°/s, Preset speed 25°/s
Operating Temperature	-40°C to 70°C (-40°F to 158°F)	-40°C to 70°C (-40°F to 158°F)	-40°C to 70°C (-40°F to 158°F)	-40°C to 65°C (-40°F to 149°F)	-30°C to 65°C (-22°F to 149°F)	-30°C to 65°C (-22°F to 149°F)
Humidity	≤ 95%	≤ 95%	≤ 95%	≤ 95%	≤ 95%	≤ 95%
Local Storage	Built-in memory card slot, support Micro SD/SDHC/SDXC, up to 256 GB; NAS (NFS, SMB/ CIFS), ANR	Built-in memory card slot, support Micro SD/SDHC/SDXC, up to 256 GB; NAS (NFS, SMB/ CIFS), ANR	Built-in memory card slot, support Micro SD/SDHC/SDXC, up to 256 GB; NAS (NFS, SMB/ CIFS), ANR	Built-in memory card slot, support Micro SD/SDHC/SDXC, up to 256 GB; NAS (NFS, SMB/ CIFS), ANR	Built-in memory card slot, support Micro SD/SDHC/SDXC, up to 128 GB; NAS (NFS, SMB/ CIFS), ANR	Built-in memory card slot, support Micro SD/SDHC/SDXC, up to 128 GB; NAS (NFS, SMB/ CIFS), ANR
Audio I/O	1/1	1/1	1/1	1/1	1/1	1/1
Alarm I/O	7/2	2/1	2/1	7/2	1/1	1/1
Power	24 VAC (Max. 90 W)	24 VAC (Max. 55 W)	24 VAC (Max. 45 W)	24 VAC & Hi-PoE Max.: 45 W	12 VDC & PoE (802.3at) Max.: 19 W	12 VDC & PoE (802.3at) Max.: 19 W

Panoramic Camera

042 PanoVu Series

046 Fisheye Series











PanoVu Series





From Expansive Scenes to Detailed Close-Ups













- > 360° / 270° / 180° image stitching
- > Multiple display modes
- > Face capture (PTZ PanoVu only)
- > Saves labor costs
- > Saves IP address costs



Model	DS-2PT3326IZ-DE3	DS-2PT3122IZ-DE3	DS-2PT3306IZ-DE3	DS-2PT5326IZ-DE
Image	 PanoVu	 PanoVu	 PanoVu	 PanoVu
Image Sensor	Fixed: 3×1/2.8" progressive scan CMOS PTZ: 1/2.8" progressive scan CMOS	Fixed: 1×1/2.8" progressive scan CMOS PTZ: 1/2.8" progressive scan CMOS	3×1/2.8" progressive scan CMOS	Fixed: 3×1/2.8" progressive scan CMOS PTZ: 1/2.8" progressive scan CMOS
Resolution	1920 × 1080	1920 × 1080	1920 × 1080	1920 × 1080
Video Compression	H.265 / H.264 / MJPEG	H.265 / H.264 / MJPEG	H.265 / H.264 / MJPEG	H.265 / H.264 / MJPEG
Min. Illumination	Color: 0.05 lux @ (F2.0, AGC ON)	Color: 0.05 lux @ (F2.0, AGC ON)	Color: 0.05 lux @ (F2.0, AGC ON)	Color: 0.005 lux @ (F1.6, AGC ON)
WDR	Digital WDR	Digital WDR	Digital WDR	Digital WDR
Lens	Fixed: 2 mm PTZ: 2.8-12 mm	Fixed: 2 mm PTZ: 2.8-12 mm	2 mm	Fixed: 4 mm PTZ: 5-50 mm
FOV	Fixed: Horizontal field of view: 128.5° Vertical field of view: 75.7° Diagonal field of view: 144° PTZ cam: Horizontal field of view: 120° to 56.6° (wild-tele) Vertical field of view: 61.8° to 31.7° (wild-tele) Diagonal field of view: 149° to 65° (wild-tele)	Panoramic cam: Horizontal field of view: 128.5° Vertical field of view: 75.7° Diagonal field of view: 144° PTZ cam: Horizontal field of view: 120° to 56.6° (wild-tele) Vertical field of view: 61.8° to 31.7° (wild-tele) Diagonal field of view: 149° to 65° (wild-tele)	Horizontal field of view: 128.5° × 3 Vertical field of view: 75.7°	Panoramic cam: Horizontal field of view: 80.7° × 3 Vertical field of view: 43.5° PTZ cam: Horizontal field of view: 58.6° to 6.4° (wide - tele)
Optical Zoom	PTZ: 4x	PTZ: 4x	-	PTZ: 10x
Max. IR Range	10 m	10 m	10 m	Panoramic cam: 30 m PTZ cam: 50 m
VCA	Audio Exception Detection, Intrusion Detection, Line Crossing Detection, motion detection	Audio Exception Detection, Intrusion Detection, Line Crossing Detection, motion detection	Audio Exception Detection, Intrusion Detection, Line Crossing Detection, motion detection	Audio Exception Detection, Intrusion Detection, Line Crossing Detection, motion detection
Frame Rate	50Hz: 25fps (1920×1080, 1280×720, 704×576, 640×480, 352×288) 60Hz: 30fps (1920×1080, 1280×720, 704×480, 640×480, 352×240)	50Hz: 25fps (1920×1080, 1280×720, 704×576, 640×480, 352×288) 60Hz: 30fps (1920×1080, 1280×720, 704×480, 640×480, 352×240)	50 Hz: 20 fps (1920 × 1080, 1280 × 960, 1280 × 720) 60 Hz: 20 fps (1920 × 1080, 1280 × 960, 1280 × 720)	50Hz: 25fps (1920×1080, 1280×720, 704×576, 640×480, 352×288) 60Hz: 30fps (1920×1080, 1280×720, 704×480, 640×480, 352×240)
Streams	2	2	2	2
Protection Level	-	-	IP66	IP66
Operating Temperature	-10°C to 50°C (14°F to 122°F)	-10°C to 50°C (14°F to 122°F)	-10°C to 50°C (14°F to 122°F)	-30°C to 65°C (-22°F to 149°F), with heater on
Humidity	Humidity 90% or less (non-condensing)	Humidity 90% or less (non-condensing)	Humidity 90% or less (non-condensing)	Humidity 90% or less (non-condensing)
Local Storage	Built-in memory card slot, support Micro SD / SDHC / SDXC, up to 256 GB	Built-in memory card slot, support Micro SD / SDHC / SDXC, up to 256 GB	Built-in memory card slot, support Micro SD / SDHC / SDXC, up to 256 GB	Built-in memory card slot, support Micro SD / SDHC / SDXC, up to 256 GB
Indoor/Outdoor	Indoor	Indoor	Indoor	Outdoor
Audio I/O	1-ch audio input and 1-ch audio output.	1-ch audio input and 1-ch audio output.	1-ch audio input and 1-ch audio output.	1-ch audio input and 1-ch audio output.
Alarm I/O	-	-	-	1-ch alarm input and 1-ch alarm output
Power	12 VDC (Max.24 W), PoE+ (Max. 25 W), IR Max. 6 W	12 VDC (Max.19 W), PoE+ (Max. 20 W), IR Max. 2 W	12 VDC & PoE+ (802.3 at, class 4) Max.20 W (Max. 6 W for IR)	12 VDC & PoE+ (802.3 at, class 4) Max.27 W (Max. 9 W for IR)

Model	DS-2DP1618ZIXS-DE/440/T2	DS-2DP2427ZIXS-DE/440/T2	DS-2DP3236ZIXS-D/440/T2	DS-2DP6436ZIXS-D/836/T2
Image	 PanoVu	 PanoVu	 PanoVu	 PanoVu
Image Sensor	Panoramic: Four 1/1.8" 4MP Progressive Scan CMOS PTZ: 1/1.8" 4MP Progressive Scan CMOS	Panoramic: Six 1/1.8" 4MP Progressive Scan CMOS PTZ: 1/1.8" 4MP Progressive Scan CMOS	Panoramic: Eight 1/1.8" 4MP Progressive Scan CMOS PTZ: 1/1.8" 4MP Progressive Scan CMOS	Panoramic: Eight 1/1.8" 8MP Progressive Scan CMOS PTZ: 2/3" 8MP Progressive Scan CMOS
Resolution	5520 × 2400	8160 × 2400	2 × 5520 × 2400	2 × 8160 × 3616
Video Compression	Main Stream: H.265 / H.264 Sub-Stream: H.265 / H.264 / MJPEG Third Stream: H.265 / H.264	Main Stream: H.265 / H.264 Sub-Stream: H.265 / H.264 / MJPEG Third Stream: H.265 / H.264	Main Stream: H.265 / H.264 Sub-Stream: H.265 / H.264 / MJPEG Third Stream: H.265 / H.264	Main Stream: H.265 / H.264 Sub-Stream: H.265 / H.264 / MJPEG Third Stream: H.265 / H.264
Min. Illumination	Panoramic: Color: 0.0005 Lux @(F1.6, AGC ON) B/W: 0.0001 Lux @(F1.6, AGC ON) PTZ: Color: 0.0005 Lux @(F1.2, AGC ON) B/W: 0.0001 Lux @(F1.2, AGC ON) 0 Lux with IR	Panoramic: Color: 0.0005 Lux @(F1.6, AGC ON) B/W: 0.0001 Lux @(F1.6, AGC ON) PTZ: Color: 0.0005 Lux @(F1.2, AGC ON) B/W: 0.0001 Lux @(F1.2, AGC ON) 0 Lux with IR	Panoramic: Color: 0.0005 Lux @(F1.6, AGC ON) B/W: 0.0001 Lux @(F1.6, AGC ON) PTZ: Color: 0.0005 Lux @(F1.2, AGC ON) B/W: 0.0001 Lux @(F1.2, AGC ON) 0 Lux with IR	Panoramic: Color: 0.0005 Lux @(F1.6, AGC ON) B/W: 0.0001 Lux @(F1.6, AGC ON) PTZ: Color: 0.005 Lux @(F1.5, AGC ON) B/W: 0.001 Lux @(F1.5, AGC ON) 0 Lux with IR
WDR	120 dB	120 dB	120 dB	DWDR
Lens	Panoramic: 2.8 mm, F1.6 PTZ: 6.0 to 240 mm, 40x optical	Panoramic: 2.8 mm, F1.6 PTZ: 6.0 to 240 mm, 40x optical	Panoramic: 2.8 mm, F1.6 PTZ: 6.0 to 240 mm, 40x optical	Panoramic: 2.8 mm, F1.6 PTZ: 7.5 to 277.5 mm, 36x optical
FOV	Panoramic: Horizontal: 180°, Vertical: 85° PTZ: Horizontal field of view: 56.6° to 1.8° (Wide-Tele) Vertical field of view: 33.7° to 1.0° (Wide-Tele) Diagonal field of view: 63.4° to 2.0° (Wide-Tele)	Panoramic: Horizontal: 270°, Vertical: 85° PTZ: Horizontal field of view: 56.6° to 1.8° (Wide-Tele) Vertical field of view: 33.7° to 1.0° (Wide-Tele) Diagonal field of view: 63.4° to 2.0° (Wide-Tele)	Panoramic: Horizontal: 2 × 180°, Vertical: 85° PTZ: Horizontal field of view: 56.6° to 1.8° (Wide-Tele) Vertical field of view: 33.7° to 1.0° (Wide-Tele) Diagonal field of view: 63.4° to 2.0° (Wide-Tele)	Panoramic: Horizontal: 2 × 180°, Vertical: 85° PTZ: Horizontal field of view: 56.1° to 2.0° (Wide-Tele) Vertical field of view: 33.4° to 1.1° (Wide-Tele) Diagonal field of view: 62.9° to 2.3° (Wide-Tele)
Optical Zoom	40x	40x	40x	36x
Max. IR Range	250 m	250 m	250 m	250 m
VCA	Panoramic: Intrusion Detection, Line Crossing Detection, Region Entrance Detection, Region Exiting Detection PTZ: Intrusion Detection, Line Crossing Detection, Region Entrance Detection, Region Exiting Detection, Unattended Baggage Detection, Object Removal Detection	Panoramic: Intrusion Detection, Line Crossing Detection, Region Entrance Detection, Region Exiting Detection PTZ: Intrusion Detection, Line Crossing Detection, Region Entrance Detection, Region Exiting Detection, Unattended Baggage Detection, Object Removal Detection	Panoramic: Intrusion Detection, Line Crossing Detection, Region Entrance Detection, Region Exiting Detection PTZ: Intrusion Detection, Line Crossing Detection, Region Entrance Detection, Region Exiting Detection, Unattended Baggage Detection, Object Removal Detection	Panoramic: Intrusion Detection, Line Crossing Detection, Region Entrance Detection, Region Exiting Detection PTZ: Intrusion Detection, Line Crossing Detection, Region Entrance Detection, Region Exiting Detection, Unattended Baggage Detection, Object Removal Detection
Frame Rate	Panoramic: 50Hz: 25fps (5520 × 2400, 4096 × 1800, 3840 × 1680, 2784 × 1200) 60Hz: 30fps (5520 × 2400, 4096 × 1800, 3840 × 1680, 2784 × 1200) PTZ: 50Hz: 25fps (2560 × 1440, 1920 × 1080, 1280 × 960, 1280 × 720) 60Hz: 30fps (2560 × 1440, 1920 × 1080, 1280 × 960, 1280 × 720)	Panoramic: 50Hz: 25fps (8160 × 2400, 6120 × 1800, 5760 × 1696, 3840 × 1080) 60Hz: 30fps (8160 × 2400, 6120 × 1800, 5760 × 1696, 3840 × 1080) PTZ: 50Hz: 25fps (2560 × 1440, 1920 × 1080, 1280 × 960, 1280 × 720) 60Hz: 30fps (2560 × 1440, 1920 × 1080, 1280 × 960, 1280 × 720)	Panoramic: 50Hz: 25fps (5520 × 2400, 3840 × 1680, 2784 × 1200) 60Hz: 30fps (5520 × 2400, 3840 × 1680, 2784 × 1200) PTZ: 50Hz: 25fps (2560 × 1440, 1920 × 1080, 1280 × 960, 1280 × 720) 60Hz: 30fps (2560 × 1440, 1920 × 1080, 1280 × 960, 1280 × 720)	Panoramic: 50Hz: 25fps 32 MP video output mode: 8160 × 3616; 8 MP video output mode: 4096 × 1800, 3840 × 1680, 2720 × 1192 60Hz: 30fps 32 MP video output mode: 8160 × 3616; 8 MP video output mode: 4096 × 1800, 3840 × 1680, 2720 × 1192 PTZ: 50Hz: 25fps (4096 × 2160, 3840 × 2160, 2560 × 1440, 1920 × 1080, 1280 × 960, 1280 × 720) 60Hz: 30fps (4096 × 2160, 3840 × 2160, 2560 × 1440, 1920 × 1080, 1280 × 960, 1280 × 720)
Streams	3	3	3	3
Protection Level	IP66, IK10	IP66, IK10	IP66, IK10	IP66, IK10
Angle Adjustment	-	-	-	-
Operating Temperature	Outdoor: -40°C to 70°C (-40°F to 158°F)	Outdoor: -40°C to 70°C (-40°F to 158°F)	Outdoor: -40°C to 60°C (-40°F to 140°F)	Outdoor: -40°C to 60°C (-40°F to 140°F)
Humidity	≤ 95%	≤ 95%	≤ 95%	≤ 95%
Local Storage	Built-in microSD slot, support microSD/microSDHC/microSDXC cards, up to 256 GB	Built-in microSD slot, support microSD/microSDHC/microSDXC cards, up to 256 GB	Built-in microSD slot, support microSD/microSDHC/microSDXC cards, up to 256 GB	Built-in microSD slot, support microSD/microSDHC/microSDXC cards, up to 256 GB
Indoor/Outdoor	Outdoor	Outdoor	Outdoor	Outdoor
Audio I/O	1-ch audio input and 1-ch audio output.	1-ch audio input and 1-ch audio output.	1-ch audio input and 1-ch audio output.	1-ch audio input and 1-ch audio output.
Alarm I/O	7-ch alarm input and 2-ch alarm output	7-ch alarm input and 2-ch alarm output	7-ch alarm input and 2-ch alarm output	7-ch alarm input and 2-ch alarm output
Power	36 VDC	36 VDC	36 VDC	36 VDC

Model	DS-2CD692460-IHS/(NFC)	DS-2CD694460-IHS/(NFC)	DS-2CD698460-IH(S)/(NFC)	DS-2CD6D24FWD-(I)Z(H)(S)/(NFC)	DS-2CD6D54FWD-(I)Z(H)(S)/(NFC)
Image	 PanoVu	 PanoVu	 PanoVu	 PanoVu	 PanoVu
Image Sensor	1/1.8" Progressive Scan CMOS	1/1.8" Progressive Scan CMOS	1/1.8" Progressive scan CMOS	1/2.7" Progressive Scan CMOS	1/2.7" Progressive Scan CMOS
Resolution	3840 × 2160 (Panorama mode)	4800 × 2688 (Panorama mode)	8160 × 3616 (Panorama mode)	1920 × 1080	2560 × 1920
Video Compression	H.265+ / H.264+ / H.265 / H.264 / MJPEG	H.265+ / H.264+ / H.265 / H.264 / MJPEG	H.265+ / H.264+ / H.265 / H.264	H.265+ / H.264+ / H.265 / H.264 / MJPEG	H.265+ / H.264+ / H.265 / H.264 / MJPEG
Min. Illumination	Color: 0.003 lux @ (F1.2, AGC ON), B/W: 0.0018 lux @ (F1.6, AGC ON), 0 lux with IR	Color: 0.009 lux @ (F1.6, AGC ON), B/W: 0.0018 lux @ (F1.6, AGC ON), 0 lux with IR	Color: 0.012 lux @ (F1.4, AGC ON), B/W: 0.0012 lux @ (F1.4, AGC ON), 0 lux with IR	Color: 0.006 Lux @ (F1.2, AGC ON), 0.01 Lux @ (F1.6, AGC ON) B/W: 0.002 Lux @ (F1.2, AGC ON); 0.003 Lux @ (F1.6, AGC ON) 0 Lux with IR on	Color: 0.006 Lux @ (F1.2, AGC ON), 0.010 Lux @ (F1.6, AGC ON) B/W: 0.002 Lux @ (F1.2, AGC ON); 0.003 Lux @ (F1.6, AGC ON) 0 Lux with IR on
WDR	Digital WDR	Digital WDR	Digital WDR	120 dB	120 dB
Lens	Four 2.8 mm/6 mm	Four 2.8 mm/6 mm	Four 2.8 mm	Four 2.8 to 12 mm	Four 2.8 to 12 mm
FOV	2.8 mm: horizontal FOV 180°, vertical FOV 90° 6 mm: horizontal FOV 180°, vertical FOV 25°	2.8 mm: horizontal FOV 180°, vertical FOV 90° 6 mm: horizontal FOV 180°, vertical FOV 25°	Single lens image: horizontal FOV 102°, vertical FOV 55°, diagonal FOV 120° Panorama Image: horizontal field of view 180°, vertical FOV 95°	Horizontal field of view: 30° to 96.3° Vertical field of view: 17° to 54° Diagonal field of view: 34° to 121°	Horizontal field of view: 30° to 101° Vertical field of view: 22.4° to 73° Diagonal field of view: 37° to 137°
Optical Zoom	-	-	-	-	-
Max. IR Range	20 m (Four IR LEDs)	20 m (Four IR LEDs)	20 m (Four IR LEDs)	30 m	30 m
VCA	-	-	-	Line crossing detection, intrusion detection, region entrance detection, region exiting detection, unattended baggage detection, object removal detection	Line crossing detection, intrusion detection, region entrance detection, region exiting detection, unattended baggage detection, object removal detection
Frame Rate	50Hz: 25fps (3840 × 2160, 2560 × 1440, 1920 × 1080) 60Hz: 30fps (3840 × 2160, 2560 × 1440, 1920 × 1080)	50Hz: 25fps (4800 × 2688, 3840 × 2160, 2688 × 1520) 60Hz: 30fps (4800 × 2688, 3840 × 2160, 2688 × 1520)	50Hz: 25fps (8160 × 3616, 8160 × 2304) 60Hz: 30fps (8160 × 3616, 8160 × 2304)	50Hz: 25fps (1920 × 1080, 1280 × 960, 1280 × 720) 60Hz: 30fps (1920 × 1080, 1280 × 960, 1280 × 720)	50Hz: 25fps (2560 × 1920, 2048 × 1536, 1920 × 1080, 1280 × 720) 60Hz: 24fps (2560 × 1920, 2048 × 1536, 1920 × 1080, 1280 × 720)
Streams	2	2	1	3	3
Protection Level	IP67, IK10	IP67, IK10	IP67, IK10	IP67, IK10	IP67, IK10
Angle Adjustment	Pan: 0° to 355°, tilt: 0° to 90°	Pan: 0° to 355°, tilt: 0° to 90°	Pan: 0° to 355°, tilt: 0° to 90°	Four flexible lens in one track, slide range: -180° to 180°, tilt: 0° to 135°, rotate: 0° to 355°	Four flexible lens in one track, slide range: -180° to 180°, tilt: 0° to 135°, rotate: 0° to 355°
Operating Temperature	-40 °C to +60 °C (-40 °F to +140 °F)	-40 °C to +60 °C (-40 °F to +140 °F)	-40 °C to +60 °C (-40 °F to +140 °F)	-30 °C to 60 °C (-22 °F to 140 °F). -H: -40 °C to 60 °C (-40 °F to 140 °F)	-30 °C to 60 °C (-22 °F to 140 °F). -H: -40 °C to 60 °C (-40 °F to 140 °F)
Humidity	Humidity 95% or less (non-condensing)	Humidity 95% or less (non-condensing)	humidity 95% or less (non-condensing)	Humidity 95% or less (non-condensing)	Humidity 95% or less (non-condensing)
Local Storage	Micro SD / SDHC / SDXC slot, up to 256 GB	Micro SD / SDHC / SDXC slot, up to 256 GB	Built-in micro SD / SDHC / SDXC slot, up to 128 GB	Built-in micro SD / SDHC / SDXC slot, up to 128 GB	Built-in micro SD / SDHC / SDXC slot, up to 128 GB
Indoor/Outdoor	Outdoor	Outdoor	Outdoor	Outdoor	Outdoor
Audio I/O	1 Input (line in/mic in, 3.5 mm), 1 output(3.5 mm)	1 Input (line in/mic in, 3.5 mm), 1 output(3.5 mm)	With S: 1 input (line in), 1 output (line out)	With -S: 1-ch 3.5 mm input (line in/Mic in), 1-ch 3.5mm output, dual-track, stereo	With -S: 1-ch 3.5 mm input (line in), 1-ch 3.5mm output, dual-track, stereo
Alarm I/O	2 Inputs, 2 outputs	2 Inputs, 2 outputs	With S: 2 Inputs, 2 outputs	With -S: 2 inputs, 2 outputs	With -S: 2 inputs, 2 outputs
Power	12 VDC & PoE(802.3at) Max.: 24W	12 VDC & PoE(802.3at) Max.: 24W	12 VDC & PoE(802.3at)	12 VDC ± 20%, 24 VAC ± 20% (for customization), three-core terminal block, -I, -IZS/NFC: Hi-PoE: 42.5 VDC to 57 VDC, -Z: PoE (802.3at)	12 VDC ± 20%, 24 VAC ± 20% (for customization), three-core terminal block, -I, -IZS/NFC, -IZHS/NFC: Hi-PoE: 42.5 VDC to 57 VDC, -Z: PoE (802.3at)



Model	DS-2CD6D5461-IZ(S)	DS-2CD6D5461-ZS/RC	DS-2CD6D5260-IH(S)	DS-2CD6D8260-IH(S)
				
Image	 	 	 	 
Image Sensor	1/2.7" Progressive Scan CMOS	1/2.7" Progressive Scan CMOS	1/2.7" Progressive Scan CMOS	1/2.5" Progressive Scan CMOS
Resolution	2560 x 1920	2560 x 1920	2560 x 1920	3840 x 2160
Video Compression	H.265+ / H.264+ / H.265 / H.264 / MJPEG	H.265+ / H.264+ / H.265 / H.264 / MJPEG	H.265+ / H.264+ / H.265 / H.264 / MJPEG	H.265+ / H.264+ / H.265 / H.264 / MJPEG
Min. Illumination	Color: 0.0125 lux @ (F1.9, AGC ON); B/W: 0.0025 lux @ (F1.9, AGC ON)	Color: 0.0125 lux @ (F1.9, AGC ON); B/W: 0.0025 lux @ (F1.9, AGC ON)	Color: 0.009 Lux @ (F1.6, AGC ON), B/W: 0.0018 Lux @ (F1.6, AGC ON), 0 Lux with IR	Color: 0.056 Lux @ (F2.0, AGC ON), 0 Lux with IR
WDR	120 dB	120 dB	120 dB	120 dB
Lens	Four 2.8 to 8 mm	Four 2.8 to 8 mm	2.8 mm/4 mm/6 mm	2.8 mm/4 mm/6 mm
FOV	Horizontal FOV 100° to 49°, vertical FOV 72° to 36.4°, diagonal FOV 134.4° to 61.4°	Horizontal FOV 100° to 49°, vertical FOV 72° to 36.4°, diagonal FOV 134.4° to 61.4°	2.8mm @ F1.6 horizontal FOV 97°, vertical FOV 70°, diagonal FOV 128° 4 mm @ F1.6, horizontal FOV 79°, vertical FOV 57°, diagonal FOV 104° 6 mm @ F1.6, horizontal FOV 49°, vertical FOV 35°, diagonal FOV 63°	2.8mm @ F2.0, horizontal FOV 103°, vertical FOV 53°, diagonal FOV 124° 4 mm @ F2.0, horizontal FOV 79°, vertical FOV 41°, diagonal FOV 94° 6 mm @ F2.0, horizontal FOV 50°, vertical FOV 27°, diagonal FOV 58°
Optical Zoom	-	-	-	-
Max. IR Range	30 m	-	10 m	10 m
VCA	Line crossing detection, intrusion detection, region entrance detection, region exiting detection, unattended baggage detection, object removal detection	Line crossing detection, intrusion detection, region entrance detection, region exiting detection, unattended baggage detection, object removal detection	-	-
Frame Rate	50Hz: 25fps (2560 × 1920, 2048 × 1536, 1920 × 1080, 1280 × 720) 60Hz: 24fps (2560 × 1920, 2048 × 1536, 1920 × 1080, 1280 × 720)	50Hz: 25fps (2560 × 1920, 2048 × 1536, 1920 × 1080, 1280 × 720) 60Hz: 24fps (2560 × 1920, 2048 × 1536, 1920 × 1080, 1280 × 720)	50Hz: 25fps (2560 × 1920, 2048 × 1536) 60Hz: 30fps (2560 × 1920, 2048 × 1536)	50Hz: 25fps (3840 × 2160, 3072 × 1728, 2560 × 1440, 1920 × 1080, 1280 × 720) 60Hz: 24fps (3840 × 2160, 3072 × 1728, 2560 × 1440, 1920 × 1080, 1280 × 720)
Streams	3	3	3	3
Protection Level	IP67, IK10	IP67, IK10	IP67, IK10	IP67, IK10
Angle Adjustment	Pan: -60° to 60°, tilt: 10° to 90°	Pan: -60° to 60°, tilt: 10° to 90°	P: -90 to 90°; T: 0 to 60° (2.8mm), 0 to 70° (4/6mm); R: 0 to 355°	P: -90 to 90°; T: 0 to 60° (2.8mm), 0 to 70° (4/6mm); R: 0 to 355°
Operating Temperature	-30 °C to 60 °C (-22 °F to 140 °F)	-30 °C to 60 °C (-22 °F to 140 °F)	-40 °C to 60 °C (-40 °F to 140 °F)	-40 °C to 60 °C (-40 °F to 140 °F)
Humidity	Humidity 95% or less (non-condensing)	Humidity 95% or less (non-condensing)	Humidity 95% or less (non-condensing)	Humidity 95% or less (non-condensing)
Local Storage	Built-in micro SD / SDHC / SDXC slot, up to 128 GB	Built-in micro SD / SDHC / SDXC slot, up to 128 GB	Built-in micro SD / SDHC / SDXC slot, up to 256 GB	Built-in micro SD / SDHC / SDXC slot, up to 256 GB
Indoor/Outdoor	Outdoor	Outdoor	Outdoor	Outdoor
Audio I/O	With S: 1 input (line in), 1 output (line out), mono sound	1 input (line in), 1 output (line out), mono sound	Without -S: 2 built-in mics With S: 2 built-in mics, 1 line in, 1 line out	Without -S: 2 built-in mics With S: 2 built-in mics, 1 line in, 1 line out
Alarm I/O	With S: 2 inputs, 2 outputs	2 inputs, 2 outputs	With S: 1 input, 1 output (max. 36 VDC, 30mA)	With S: 1 input, 1 output (max. 36 VDC, 30mA)
Power	12 VDC ± 20%, reverse polarity protection; three-core terminal block 24 VAC ± 20%; PoE (802.3at, class 4)	12 VDC ± 20%, reverse polarity protection; three-core terminal block 24 VAC ± 20%; PoE (802.3af, class 0)	12 VDC & PoE (802.3af)	12 VDC & PoE (802.3af)





Fisheye Series

Single Sensor Panorama Camera

- > 360° / 180° overview
- > Multiple display modes
- > ImmerVision lens (DS-2CD63C5G0 only)
- > Deep Learning heat map (optional)
- > Deep Learning intersection flow analysis (optional)
- > Deep Learning people counting (optional)
- > Supports onboard dewarping



Model	DS-2CD63C5G0-IV(S)	DS-2CD6365G0-IV(S)
Image	 <p>IMMERVISION</p> <p>Heat map, intersection analysis, people counting with Deep Learning algorithm, onboard dewarping and client dewarping, built-in microphone and speaker, ImmerVision lens</p>	 <p>Heat map, intersection analysis, people counting with Deep Learning algorithm, onboard dewarping and client dewarping, built-in microphone and speaker</p>
Image Sensor	1/1.7" Progressive Scan CMOS	1/1.8" Progressive Scan CMOS
Max.Resolution	4000 × 3000	3072 × 2048
Video Compression	H.265+ / H.265 / H.264+ / H.264 / MJPEG	H.265+ / H.265 / H.264+ / H.264 / MJPEG
Min. Illumination	Color: 0.05 lux @ (F2.2, AGC ON), B/W: 0.01 lux @ (F2.2, AGC ON), 0 lux with IR	Color: 0.047 lux @ (F2.6, AGC ON), B/W: 0.0047 lux @ (F2.6, AGC ON), 0 lux with IR
WDR	DWDR	DWDR
Lens	1.29 mm	1.27 mm
FOV	Horizontal FOV: 180°, vertical FOV: 180°	Horizontal FOV 180° (wall mount), 360°(ceiling mount), 360°(table mount)
Max. IR Range	15 m (three independently controlled LEDs)	15 m (three independently controlled LEDs)
VCA	Line crossing detection, intrusion detection, region entrance detection, region exiting detection, unattended baggage detection, object removal detection;Heat map with Deep Learning algorithm;Intersection analysis;People Counting	Line crossing detection, intrusion detection, region entrance detection, region exiting detection, unattended baggage detection, object removal detection;Heat map with Deep Learning algorithm;Intersection analysis;People Counting
Frame Rate	50Hz: 20fps (4000 × 3000), 25fps (3000 × 3000, 2560 × 2560) 60Hz: 20fps (4000 × 3000), 30fps (3000 × 3000, 2560 × 2560)	50Hz: 25fps (3072 × 2048, 2048 × 2048, 1280 × 1280) 60Hz: 30fps (3072 × 2048, 2048 × 2048, 1280 × 1280)
Streams	2	2
Protection Level	With -V: IP67, IK10	With -V: IP67, IK10
Angle Adjustment	-	-
Operating Temperature	-40 °C to 60 °C (-40 °F to +140 °F) Heater	-40 °C to 60 °C (-40 °F to +140 °F) Heater
Humidity	humidity 95% or less (non-condensing)	humidity 95% or less (non-condensing)
Local Storage	Support microSD/SDHC/SDXC card (256 G), local storage and NAS (NFS,SMB/CIFS), ANR	Support microSD/SDHC/SDXC card (256 G), local storage and NAS (NFS,SMB/CIFS), ANR
Indoor/Outdoor	indoor/outdoor	indoor/outdoor
Audio I/O	2 built-in microphones, 1 built-in speaker, mono sound -S: 1 Audio input (line in, 3.5 mm), 1 audio output (line out, 3.5 mm)	2 built-in microphones, 1 built-in speaker, mono sound -S: 1 Audio input (line in, 3.5 mm), 1 audio output (line out, 3.5 mm)
Alarm I/O	With -S: 1-ch alarm input, max. 12 V; 1-ch alarm output, max 24 VDC, 1 A	With -S: 1-ch alarm input, max. 12 V; 1-ch alarm output, max 24 VDC, 1 A
Power	12 VDC±20%, PoE (802.3at, class 4), -S model: two-core terminal block Without -S model: Ø 5.5 × 2.1 mm coaxial power plug	12 VDC±20%, PoE (802.3at, class 4), -S model: two-core terminal block Without -S model: Ø 5.5 × 2.1 mm coaxial power plug

Model	DS-2CD63C560E-I(V)(S)	DS-2CD636560E-I(V)(S)	DS-2CD63C560E-S/RC	DS-2CD636560E-S/RC
Image	 <p>Onboard dewarping and client dewarping, built-in microphone and speaker</p>	 <p>Onboard dewarping and client dewarping, built-in microphone and speaker</p>	 <p>Onboard dewarping and client dewarping, in-ceiling installation</p>	 <p>Onboard dewarping and client dewarping, in-ceiling installation</p>
Image Sensor	1/1.7" Progressive Scan CMOS	1/1.8" Progressive Scan CMOS	1/1.7" Progressive Scan CMOS	1/1.8" Progressive Scan CMOS
Max.Resolution	4000 × 3000	3072 × 2048	4000 × 3000	3072 × 2048
Video Compression	H.265+ / H.265 / H.264+ / H.264 / MJPEG	H.265+ / H.265 / H.264+ / H.264 / MJPEG	H.265+ / H.265 / H.264+ / H.264 / MJPEG	H.265+ / H.265 / H.264+ / H.264 / MJPEG
Min. Illumination	Color: 0.082 lux @ (F2.8, AGC ON), B/W: 0.016 lux @ (F2.8, AGC ON), 0 lux with IR	Color: 0.047 lux @ (F2.6, AGC ON), B/W: 0.0047 lux @ (F2.6, AGC ON), 0 lux with IR	Color: 0.06 lux @ (F2.4, AGC ON), B/W: 0.012 lux @ (F2.4, AGC ON)	Color: 0.047 lux @ (F2.6, AGC ON), B/W: 0.0047 lux @ (F2.6, AGC ON)
WDR	DWDR	DWDR	DWDR	DWDR
Lens	2 mm	1.27 mm	2 mm	1.27 mm
FOV	Horizontal FOV 180° (wall mount), 360°(ceiling mount), 360°(table mount)	Horizontal FOV 180° (wall mount), 360°(ceiling mount), 360°(table mount)	360° (In-ceiling mounting)	360° (In-ceiling mounting)
Max. IR Range	15 m (three independently controlled LEDs)	15 m (three independently controlled LEDs)	-	-
VCA	Line crossing detection, intrusion detection, region entrance detection, region exiting detection, unattended baggage detection, object removal detection;	Line crossing detection, intrusion detection, region entrance detection, region exiting detection, unattended baggage detection, object removal detection;	Line crossing detection, intrusion detection, region entrance detection, region exiting detection, unattended baggage detection, object removal detection;	Line crossing detection, intrusion detection, region entrance detection, region exiting detection, unattended baggage detection, object removal detection;
Frame Rate	50Hz: 20fps (4000 × 3000), 25fps (3000 × 3000, 2560 × 2560) 60Hz: 20fps (4000 × 3000), 30fps (3000 × 3000, 2560 × 2560)	50Hz: 25fps (3072 × 2048, 2048 × 2048, 1280 × 1280) 60Hz: 30fps (3072 × 2048, 2048 × 2048, 1280 × 1280)	50Hz: 20fps (4000 × 3000), 25fps (3000 × 3000, 2560 × 2560) 60Hz: 20fps (4000 × 3000), 30fps (3000 × 3000, 2560 × 2560)	50Hz: 25fps (3072 × 2048, 2048 × 2048, 1280 × 1280) 60Hz: 30fps (3072 × 2048, 2048 × 2048, 1280 × 1280)
Streams	2	2	2	2
Protection Level	With -V: IP67, IK10	With -V: IP67, IK10	-	-
Angle Adjustment	-	-	-	-
Operating Temperature	-40 °C to 60 °C (-40 °F to +140 °F) Heater	-40 °C to 60 °C (-40 °F to +140 °F) Heater	-10 °C to +40 °C (14 °F to +104 °F)	-10 °C to +40 °C (14 °F to +104 °F)
Humidity	humidity 95% or less (non-condensing)	humidity 95% or less (non-condensing)	humidity 95% or less (non-condensing)	humidity 95% or less (non-condensing)
Local Storage	Support microSD/SDHC/SDXC card (256 G), local storage and NAS (NFS,SMB/CIFS), ANR	Support microSD/SDHC/SDXC card (256 G), local storage and NAS (NFS,SMB/CIFS), ANR	Support microSD/SDHC/SDXC card (256 G), local storage and NAS (NFS,SMB/CIFS), ANR	Support microSD/SDHC/SDXC card (256 G), local storage and NAS (NFS,SMB/CIFS), ANR
Indoor/Outdoor	indoor/outdoor	indoor/outdoor	indoor	indoor
Audio I/O	With -S: 1 Audio input (line in, 3.5 mm), 1 audio output (line out, 3.5 mm); 2 built-in microphone, 1 built-in speaker, mono sound	With -S: 1 Audio input (line in, 3.5 mm), 1 audio output (line out, 3.5 mm); 2 built-in microphone, 1 built-in speaker, mono sound	1 Audio input (line in, 3.5 mm), 1 audio output (line out, 3.5 mm); 2 built-in microphones, mono sound	1 Audio input (line in, 3.5 mm), 1 audio output (line out, 3.5 mm); 2 built-in microphones, mono sound
Alarm I/O	With -S: 1-ch alarm input, max. 12 V; 1-ch alarm output, max 24 VDC, 1 A	With -S: 1-ch alarm input, max. 12 V; 1-ch alarm output, max 24 VDC, 1 A	1-ch alarm input, max. 12 V; 1-ch alarm output, max 12 VDC, 0.5 A	1-ch alarm input, max. 12 V; 1-ch alarm output, max 12 VDC, 0.5 A
Power	12 VDC±20%, PoE (802.3af, class 0) -S model: two-core terminal block Without -S model: Ø 5.5 × 2.1 mm coaxial power plug	12 VDC±20%, PoE (802.3af, class 0), -S model: two-core terminal block Without -S model: Ø 5.5 × 2.1 mm coaxial power plug	12 VDC±20%, PoE (802.3af, class 3), two-core terminal block	12 VDC±20%, PoE (802.3af, class 3), two-core terminal block

Explosion-Proof & Anti-Corrosion Series

049 Explosion-Proof Series

053 Anti-Corrosion Series







Explosion-Proof Series







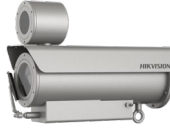

Complete Protection with Superior Design Inside and Out

- > Explosion-proof certification: ATEX, IECEx, ULEx
- > Anti-corrosion certification: NEMA-4X, C5
- > 316L Stainless Steel
- > DarkFighter (optional)
- > Smart function: Hard hat detection (optional)
- > H.265+/H.265 codec









Camera

Model	DS-2XE6025G0-I	DS-2XE6126FWD-HS	DS-2XE6222F-IS	DS-2XE6242F-IS	DS-2XE6422FWD-IZHRS	DS-2XE6442F-IZHRS
Image	 ATEX, IECEx, Mobile Certification, C5	 ATEX, IECEx, C5, NEMA 4X	 ATEX, IECEx, C5, NEMA 4X	 ATEX, IECEx, C5, NEMA 4X	 ATEX, IECEx, C5, NEMA 4X	 ATEX, IECEx, C5, NEMA 4X
Image Sensor	1/2.8" Progressive Scan CMOS	1/2.8" Progressive Scan CMOS	1/2.7" Progressive Scan CMOS	1/3" Progressive Scan CMOS	1/1.8" Progressive Scan CMOS	1/1.8" Progressive Scan CMOS
Max. Resolution	1920 × 1080	1920 × 1080	1920 × 1080	2560 × 1440	1920 × 1080	2688 × 1520
Video Compression	H.265+ / H.265 / H.264+ / H.264 / MJPEG	H.265+ / H.265 / H.264+ / H.264 / MJPEG	H.265+ / H.265 / H.264+ / H.264 / MJPEG	H.265+ / H.265 / H.264+ / H.264 / MJPEG	H.265+ / H.265 / H.264+ / H.264 / MJPEG	H.265+ / H.265 / H.264+ / H.264 / MJPEG
Min. Illumination	Color: 0.009 lux @ (F1.6, AGC ON) B/W: 0.004 lux @ (F1.6, AGC ON), 0 lux with IR	Color: 0.005 lux @ (F1.6, AGC ON) B/W: 0.017 lux @ (F1.6, AGC ON)	0.01 lux @ (F1.2, AGC ON), 0 lux with IR	0.01 lux @ (F1.2, AGC ON), 0 lux with IR	0.001 lux @ (F1.2, AGC ON), 0 lux with IR	Color: 0.0005 Lux @ (F1.2, AGC ON) B/W: 0.0001 Lux @ (F1.2, AGC ON), 0 Lux with IR
WDR	120 dB	120 dB	120 dB	120 dB	120 dB	120 dB
Lens	4, 6 or 8 mm	2, 2.8, 4 or 6 mm	4, 6, 8 or 12 mm	4, 6, 8 or 12 mm	2.8-12 mm, 8-32 mm	2.8-12 mm, 8-32 mm
FOV	4 mm, horizontal FOV: 82.6°, vertical FOV: 43.4°, diagonal FOV: 96.6° 6 mm, horizontal FOV: 51.2°, vertical FOV: 27.2°, diagonal FOV: 59.2° 8 mm, horizontal FOV: 38.7°, vertical FOV: 21.3°, diagonal FOV: 44.8°	2 mm: horizontal FOV 126.5°, vertical FOV 73.8°, diagonal FOV 144° 2.8 mm: horizontal FOV 108°, vertical FOV 59.3°, diagonal FOV 129° 4 mm: horizontal FOV 86°, vertical FOV 46°, diagonal FOV 102.3° 6 mm: horizontal FOV 52.8°, vertical FOV 29.7°, diagonal FOV 60.7°	4 mm, horizontal field of view: 91° 6 mm, horizontal field of view: 60° 8 mm, horizontal field of view: 41.5° 12 mm, horizontal field of view: 26.6°	4 mm, horizontal field of view: 83° 6 mm, horizontal field of view: 55.4° 8 mm, horizontal field of view: 38.5° 12 mm, horizontal field of view: 24.7°	2.8 mm to 12 mm, horizontal FOV: 85° to 31°, vertical FOV: 45° to 17.5°, diagonal FOV: 101° to 17.5° 8 mm to 32 mm, horizontal field of view: 42.2° to 13.5°, vertical FOV: 23.4° to 7.7°, diagonal FOV: 49° to 15.3°	2.8 mm to 12 mm, horizontal FOV: 70° to 34°, vertical FOV: 52° to 24°, diagonal FOV: 90° to 41° 8 mm to 32 mm, F1.7, horizontal field of view: 42.2° to 15.1°, vertical FOV: 23.4° to 8.6°, diagonal FOV: 49.6° to 17.3°
Max. IR Range	30 m	N/A	30 m	30 m	2.8-12 mm lens: 80 m (262.5 ft.) 8-32 mm lens: 150 m (492.1 ft.)	2.8-12 mm lens: 80 m (262.5 ft.) 8-32 mm lens: 150 m (492.1 ft.)
VCA	Line crossing detection, intrusion detection, region entrance detection, region exiting detection, unattended baggage detection, object removal detection, Face detection	Line crossing detection, intrusion detection, region entrance detection, region exiting detection, unattended baggage detection, object removal detection, Face detection	Line crossing detection, intrusion detection, region entrance detection, region exiting detection, unattended baggage detection, object removal detection, Face detection	Line crossing detection, intrusion detection, region entrance detection, region exiting detection, unattended baggage detection, object removal detection, Face detection	Line crossing detection, intrusion detection, region entrance detection, region exiting detection, unattended baggage detection, object removal detection, Face detection	Line crossing detection, intrusion detection, region entrance detection, region exiting detection, unattended baggage detection, object removal detection, Face detection
Frame Rate	50Hz: 25fps (1920 × 1080, 1280 × 960, 1280 × 720) 60Hz: 30fps (1920 × 1080, 1280 × 960, 1280 × 720)	50Hz: 25fps (1920 × 1080, 1280 × 960, 1280 × 720) 60Hz: 30fps (1920 × 1080, 1280 × 960, 1280 × 720)	50Hz: 25fps (1920 × 1080, 1280 × 960, 1280 × 720) 60Hz: 30fps (1920 × 1080, 1280 × 960, 1280 × 720)	50Hz: 25fps (2560 × 1440, 1920 × 1080, 1280 × 960, 1280 × 720) 60Hz: 24fps (2560 × 1440, 1920 × 1080, 1280 × 960, 1280 × 720)	50Hz: 50fps (1920 × 1080, 1280 × 960, 1280 × 720) 60Hz: 60fps (1920 × 1080, 1280 × 960, 1280 × 720)	50 Hz: 25fps (2688 × 1520, 2304 × 1296, 1920 × 1080, 1280 × 720) 60 Hz: 30 fps (2688 × 1520, 2304 × 1296, 1920 × 1080, 1280 × 720)
Multi-Streaming	3	3	3	3	3	3
Protection Level	IP68, IK08	IP68	-	-	IP68	IP68
Angle Adjustment	Pan: 0° to 90°, tilt: 0° to 60°	2mm: pan: 0° to 340°, tilt: 0° to 60° 2.8 mm, 4 mm, 6 mm: 0° to 340°, tilt: 0° to 75°	-	-	-	-
Operating Temperature	-30 °C to +60 °C (-22 °F to +140 °F)	-40°C to 60°C (-40°F to 140°F)	-30 °C to +60 °C (-22 °F to +140 °F)	-30 °C to +60 °C (-22 °F to +140 °F)	- 40 °C to +60 °C (-40 °F to +140 °F)	- 40 °C to +60 °C (-40 °F to +140 °F)
Operating Humidity	≤ 95%	≤ 95%	≤ 95%	≤ 95%	≤ 95%	≤ 95%
Local Storage	128 GB	128 GB	128 GB	128 GB	128 GB	128 GB
Audio I/O	-	1 in, 1 out	N/A	N/A	1 in, 1 out	1 in, 1 out
Alarm I/O	-	1 in, 1 out	2 in, 2 out	2 in, 2 out	2 in, 2 out	2 in, 2 out
Installation	Outdoor	Outdoor	Outdoor	Outdoor	Outdoor	Outdoor
Power Supply	24 VDC, reverse polarity protection PoE (802.3af, 36 to 57 VDC), 0.3 A to 0.2 A, max. 7.5 W -I/-IS: Ø5.5 mm coaxial power plug -IM: two-core WAGO connector	12 VDC ±20%, PoE (802.3af, class 3) Terminal block for DC input	AC 100 V to 240 V, 0.1A, terminal block PoE (802.3af, class 3), 0.2A	AC 100 V to 240 V, 0.1A, terminal block PoE (802.3af, class 3), 0.2A	100 VAC to 240 VAC, three-core terminal block PoE (802.3af, class 4)	100 VAC to 240 VAC, three-core terminal block PoE (802.3af, class 4)

Model	DS-2XE682560-II(L)Z(H)(S)	DS-2XE684560-II(L)Z(H)(S)	DS-2XE688560-II(L)Z(H)(S)
Image	 	 	 
			
Image Sensor	1/2.8" Progressive Scan CMOS	1/2.8" Progressive Scan CMOS	1/2" Progressive Scan CMOS
Max. Resolution	1920 × 1080	2688 × 1520	3840 × 2160
Video Compression	Main Stream: H.265+ / H.265 / H.264+ / H.264	Main Stream: H.265+ / H.265 / H.264+ / H.264	Main Stream: H.265+ / H.265 / H.264+ / H.264
Min. Illumination	Color: 0.009 Lux @ (F1.2, AGC ON)	Color: 0.009 Lux @ (F1.2, AGC ON)	Color: 0.009 Lux @ (F1.2, AGC ON)
WDR	120 dB	120 dB	120 dB
Lens	2.8-12 mm, 8-32 mm	2.8-12 mm, 8-32 mm	2.8-12 mm, 8-32 mm
FOV	2.8 to 12 mm, horizontal FOV 115° to 42°, vertical FOV 59° to 24°, diagonal FOV 141° to 48°; 8 to 32 mm, horizontal FOV 43° to 15°, vertical FOV 23° to 9°, diagonal FOV 50° to 17°	2.8 to 12 mm, horizontal FOV 115° to 42°, vertical FOV 59° to 24°, diagonal FOV 141° to 48°; 8 to 32 mm, horizontal FOV 43° to 15°, vertical FOV 23° to 9°, diagonal FOV 50° to 17°	2.8 to 12 mm, horizontal FOV 112° to 41°, vertical FOV 58° to 23°, diagonal FOV 137° to 47°; 8 to 32 mm, horizontal FOV 42° to 15°, vertical FOV 23° to 8°, diagonal FOV 49° to 17°
Max. IR Range	-I model: up to 100 m IR range -L model: up to 30 m whitelight range	-I model: up to 100 m IR range -L model: up to 30 m whitelight range	-I model: up to 100 m IR range -L model: up to 30 m whitelight range
VCA	Line crossing detection, intrusion detection, region entrance detection, region exiting detection, unattended baggage detection, object removal detection, Scene change detection, audio exception detection (-S model), defocus detection, Face Capture, Hard Hat Detection	Line crossing detection, intrusion detection, region entrance detection, region exiting detection, unattended baggage detection, object removal detection, Scene change detection, audio exception detection (-S model), defocus detection, Face Capture, Hard Hat Detection	Line crossing detection, intrusion detection, region entrance detection, region exiting detection, unattended baggage detection, object removal detection, Scene change detection, audio exception detection (-S model), defocus detection, Face Capture, Hard Hat Detection
Frame Rate	50Hz: 50fps (1920 × 1080, 1280 × 720); 60Hz: 60fps (1920 × 1080, 1280 × 720)	50Hz: 25fps (2688 × 1520, 2560 × 1440, 1920 × 1080, 1280 × 720); 60Hz: 30fps (2688 × 1520, 2560 × 1440, 1920 × 1080, 1280 × 720)	50Hz: 25fps (3840 × 2160, 3072 × 1728, 2560 × 1440, 1920 × 1080, 1280 × 720); 60Hz: 30fps (3840 × 2160, 3072 × 1728, 2560 × 1440, 1920 × 1080, 1280 × 720)
Multi-Streaming	5	5	5
Protection Level	IP68	IP68	IP68
Angle Adjustment	-	-	-
Operating Temperature	H model: -40 °C to +60 °C (-40 °F to +140 °F) Without -H model: -30 °C to +60 °C (-22 °F to +140 °F)	H model: -40 °C to +60 °C (-40 °F to +140 °F) Without -H model: -30 °C to +60 °C (-22 °F to +140 °F)	H model: -40 °C to +60 °C (-40 °F to +140 °F) Without -H model: -30 °C to +60 °C (-22 °F to +140 °F)
Operating Humidity	≤ 95%	≤ 95%	≤ 95%
Local Storage	256 GB	256 GB	256 GB
Audio I/O	1 in, 1 out	1 in, 1 out	1 in, 1 out
Alarm I/O	1 in, 1 out	1 in, 1 out	1 in, 1 out
Installation	Outdoor	Outdoor	Outdoor
Power Supply	100 to 240 VAC, PoE (42.5 to 57 V, 802.3 at), terminal block	100 to 240 VAC, PoE (42.5 to 57 V, 802.3 at), terminal block	100 VAC to 240 VAC, three-core terminal block PoE (802.3at, class 4)

Model	DS-2DB42231-CX(WE/316L)	DS-2DB4236I-CWX(WE/316L)
Image	 	 
	 	 
Image Sensor	1/1.8" Progressive Scan CMOS	1/1.8" Progressive Scan CMOS
Resolution	1920 × 1080	1920 × 1080
Video Compression	Main Stream: H.265+ / H.265 / H.264+ / H.264	Main Stream: H.265+ / H.265 / H.264+ / H.264
Min. Illumination	Color: 0.002 lux @ (F1.5, AGC ON)	Color: 0.002 lux @ (F1.5, AGC ON)
WDR	DWDR	DWDR
Lens	5.9 to 135.7 mm, 23x optical	5.7 to 205 mm, 36x optical
FOV	Horizontal field of view: 59.8° to 3.0° (WideTele) Vertical field of view: 33.6° to 1.7° (Wide-Tele) Diagonal field of view: 68.6° to 3.4° (Wide-Tele)	Horizontal field of view: 59.8° to 2.0° (wide-tele) Vertical field of view: 33.6° to 1.1° (wide-tele) Diagonal field of view: 68.6° to 2.3° (wide-tele)
Optical Zoom	23x	36x
Max. IR Range	200 m	200 m
VCA	Intrusion Detection, Line Crossing Detection, Audio Exception Detection	Intrusion Detection, Line Crossing Detection, Audio Exception Detection
Frame Rate	50Hz: 25fps (1920 × 1080, 1280 × 960, 1280 × 720) 60Hz: 30fps (1920 × 1080, 1280 × 960, 1280 × 720)	50Hz: 25fps (1920 × 1080, 1280 × 960, 1280 × 720) 60Hz: 30fps (1920 × 1080, 1280 × 960, 1280 × 720)
Streams	3	3
Protection Level	IP68 Standard; TVS 6000V Lightning Protection, Surge Protection and Voltage Transient Protection	IP68 Standard; TVS 6000V Lightning Protection, Surge Protection and Voltage Transient Protection
Angle Adjustment	-	-
Operating Temperature	-40°C to 60°C (-40° F to 140° F)	-40°C to 60°C (-40° F to 140° F)
Humidity	≤ 95%	≤ 95%
Local Storage	128 GB	128 GB
Indoor/Outdoor	Outdoor	Outdoor
Audio I/O	1/1	1/1
Alarm I/O	1/1	1/1
Power	100 VAC to 240 VAC & PoE+ (IEEE802.3at class4) Max. 25 W	100 VAC to 240 VAC & PoE+ (IEEE802.3at class4) Max. 25 W
Interface	1 × RJ45 10 M/100 M Ethernet interface	1 × RJ45 10 M/100 M Ethernet interface



Model	DS-2DY9236I-CWX (W/316L)	DS-2DF6223-CX (W316L)	DS-2DF4220-DX
Image	  ATEX, IECEx, C5, NEMA 4X	  ATEX, IECEx, C5, NEMA 4X	   ATEX, IECEx, C5, NEMA 4X
Image Sensor	1/1.8" Progressive Scan CMOS	1/1.9" progressive scan CMOS	1/2.8" Progressive Scan CMOS
Max. Resolution	1920 × 1080	1920 × 1080	1920 × 1080
Video Compression	H.265+ / H.265 / H.264+ / H.264 / MJPEG	Main Stream: H.265+ / H.265 / H.264+ / H.264	Main Stream: H.265+ / H.265 / H.264+ / H.264
Min. Illumination	Color: 0.002 lux @ (F1.5, AGC ON) B/W: 0.0002 lux @ (F1.5, AGC ON) 0 lux with IR	Color: 0.002 lux @ (F1.5, AGC ON)	Color: 0.015 Lux @ (F2.8, AGC ON)
WDR	120 dB	120 dB	DWDR
Lens	5.7 to 205 mm, 36x optical	5.9 to 135.7 mm, 23x optical	4.7 mm to 94 mm, 20x optical
FOV	Horizontal field of view: 59.8° to 2.0° (Wide-Tele) Vertical field of view: 35° to 1.1° (Wide-Tele) Diagonal field of view: 66.2° to 2.3° (Wide-Tele)	59.8° to 3.0° (Wide-Tele)	Horizontal FOV: 54.5° to 4° (Wide-Tele) Vertical FOV: 31.5° to 2.5° (Wide-Tele) Diagonal FOV: 61.5° to 4.5° (Wide-Tele)
Max. IR Range	150 m	-	-
VCA	Face Detection, Audio Exception Detection, Intrusion Detection, Line Crossing Detection, Region Entrance Detection, Region Exiting Detection	Intrusion, Line Crossing, Region Entrance, Region Exiting	Intrusion detection, line crossing detection, region entrance detection, region exiting detection, unattended baggage detection, object removal detection
Frame Rate	50Hz: 25fps (1920 × 1080, 1280 × 960, 1280 × 720) 60Hz: 30fps (1920 × 1080, 1280 × 960, 1280 × 720)	50Hz: 25fps (1920 × 1080, 1280 × 960, 1280 × 720) 50fps (1920 × 1080, 1280 × 960, 1280 × 720) 60Hz: 30fps (1920 × 1080, 1280 × 960, 1280 × 720) 60fps (1920 × 1080, 1280 × 960, 1280 × 720)	50Hz: 25fps (1920 × 1080, 1280 × 960, 1280 × 720) 60Hz: 30fps (1920 × 1080, 1280 × 960, 1280 × 720)
Multi-Streaming	3	3	3
Protection Level	IP68	IP68	IP68
Angle Adjustment	Movement Range (Pan) 360° endless, Movement Range (Tilt) From -90° to 90° (auto-flip)	-	-
Operating Temperature	-40°C to 60°C [-40°F to 140°F]	-40°C to 60°C [-40°F to 140°F]	-30°C to 60°C [-22°F to 140°F]
Operating Humidity	≤ 95%	≤ 95%	≤ 95%
Local Storage	256GB	128 GB	128 GB
Audio I/O	1 in, 1 out	1 in, 1 out	-
Alarm I/O	7-ch alarm input and 2-ch alarm output	7 in, 2 out	1 in, 1 out
Installation	Outdoor	Outdoor	Outdoor
Power Supply	100 VAC to 240 VAC Max.: 100 W (Max. 15 W for IR)	100 VAC to 240 VAC, Max.: 60 W	DC9-12V, Max. 12 W; POE



Anti-Corrosion Series

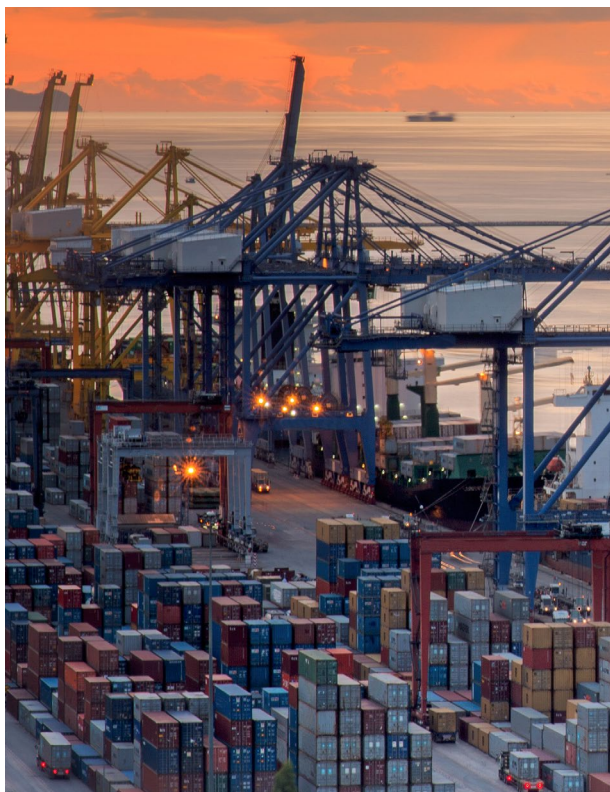

The Best Choice for Critical Industry Applications

- > Anti-corrosion certification: NEMA-4X, C5
- > 316L Stainless Steel housing or anticorrosive coating
- > DarkFighter (optional)
- > H.265+/H.265 codec



Model	DS-2XC6122FWD-IS	DS-2XC6142FWD-IS	DS-2CD6626DS-IZ(HIS)
Image	 NEMA 4X, C5	 NEMA 4X, C5	 DarkFighter + NEMA 4X; DarkFighter, C5
Image Sensor	1/2.7" Progressive Scan CMOS	1/3" Progressive Scan CMOS	1/1.8" Progressive Scan CMOS
Max. Resolution	1920 × 1080	2560 × 1440	1920 × 1080
Video Compression	H.265+ / H.265 / H.264+ / H.264 / MJPEG	H.265+ / H.265 / H.264+ / H.264 / MJPEG	H.264 / MJPEG / MPEG4
Min. Illumination	0.028 lux @ (F2.0, AGC ON), 0 lux with IR	0.028 lux @ (F2.0, AGC ON), 0 lux with IR	Color: 0.002 lux @ (F1.2, AGC ON) B/W: 0.0002 lux @ (F1.2, AGC ON)
WDR	120 dB	120 dB	120 dB
Lens	2.8, 4 or 6 mm	4 or 6 mm	2.8 to 12 mm
FOV	2.8mm, horizontal field of view: 100°, vertical field of view: 53° 4mm, horizontal field of view: 91°, vertical field of view: 49° 6mm horizontal field of view: 60°, vertical field of view: 32.5°	4mm, horizontal field of view: 83°, vertical field of view: 44.7° 6mm horizontal field of view: 55.4°, vertical field of view: 30.4°	horizontal field of view: 92° to 32°
Max. IR Range	10 m	10 m	30 m
VCA	Line crossing detection, intrusion detection, region entrance detection, region exiting detection, unattended baggage detection, object removal detection, Face detection	Line crossing detection, intrusion detection, region entrance detection, region exiting detection, unattended baggage detection, object removal detection, Face detection	Line crossing detection, intrusion detection, region entrance detection, region exiting detection, unattended baggage detection, object removal detection
Frame Rate	2.8mm lens camera: 50Hz: 25fps (1920 × 1080, 1280 × 960, 1280 × 720) 60Hz: 24fps (1920 × 1080, 1280 × 960, 1280 × 720) 4mm and 6mm lens camera: 50Hz: 25fps (1920 × 1080, 1280 × 960, 1280 × 720) 60Hz: 30fps (1920 × 1080, 1280 × 960, 1280 × 720)	50Hz: 25fps (2560 × 1440, 1920 × 1080, 1280 × 720, 528 × 384) 60Hz: 24fps (2560 × 1440, 1920 × 1080, 1280 × 720, 528 × 384)	50 Hz: 50 fps (1920 × 1080, 1280 × 960, 1280 × 720) 60 Hz: 60 fps (1920 × 1080, 1280 × 960, 1280 × 720)
Multi-Streaming	3	3	3
Protection Level	IP67	IP67	IP67
Angle Adjustment	Tilt: 0° to 75°; Pan: -30° to 30°; Rotate: 0° to 360°	Tilt: 0° to 75°; Pan: -30° to 30°; Rotate: 0° to 360°	Pan: 0° to 355°, tilt: 0° to 75°, rotation: 0° to 355°
Operating Temperature	-30 °C to +60 °C [-22 °F to +140 °F]	-30 °C to +60 °C [-22 °F to +140 °F]	-40 °C to +60 °C [-22 °F to +140 °F]
Operating Humidity	≤ 95%	≤ 95%	≤ 95%
Local Storage	128 GB	128 GB	128 GB
Audio I/O	-	-	1 in, 1 out
Alarm I/O	1 in, 1 out	1 in, 1 out	1 in, 1 out
Installation	Outdoor	Outdoor	Outdoor
Power Supply	12 VDC, 330mA, termi-l block PoE (802.3af, class 3), 0.1A	12 VDC, 0.4A, 5W, terminal block PoE (802.3af, class 3), 0.1A	24 VAC / 12 VDC / PoE (802.3at)

Model	DS-2XC6625G0-IZHRS	DS-2XC6645G0-IZHRS	DS-2XC6685G0-IZHRS
Image	 NEMA 4X, C5	 NEMA 4X, C5	 NEMA 4X, C5
Image Sensor	1/1.8" Progressive Scan CMOS	1/1.8" Progressive Scan CMOS	1/2" Progressive Scan CMOS
Max. Resolution	1920 × 1080	2688 × 1520	3840 × 2160
Video Compression	H.265+/H.265/H.264+/H.264/MJPEG	H.265+/H.265/H.264+/H.264/MJPEG	H.265+/H.265/H.264+/H.264/MJPEG
Min. Illumination	Color: 0.0005 Lux @(F1.2, AGC ON) B/W: 0.0001 Lux @(F1.2, AGC ON), 0 Lux with IR	Color: 0.0005 Lux @(F1.2, AGC ON) B/W: 0.0001 Lux @(F1.2, AGC ON), 0 Lux with IR	*Color: 0.002 Lux @(F1.2, AGC ON) B/W: 0.0002 Lux @(F1.2, AGC ON), 0 Lux with IR
WDR	120 dB	120 dB	120 dB
Lens	2.8 to 12 mm, 8 to 32mm	2.8 to 12 mm, 8 to 32mm	2.8 to 12 mm, 8 to 32mm
FOV	2.8 - 12 mm, F1.4: horizontal field of view, 94.2° to 38.1° 8 - 32 mm, F1.7: horizontal field of view, 42.2° to 15.1°	2.8 - 12 mm, F1.4: horizontal field of view, 94.2° to 38.1° 8 - 32 mm, F1.4: horizontal field of view, 42.2° to 15.1°	2.8 - 12 mm, F1.4: horizontal field of view, 94.8° to 38.2° 8 - 32 mm, F1.4: horizontal field of view, 41.8° to 14.9°
Max. IR Range	2.8-12 mm: 80 m 8-32 mm: 150 m	2.8-12 mm: 80 m 8-32 mm: 150 m	2.8-12 mm: 80 m 8-32 mm: 150 m
VCA	Line crossing detection, intrusion detection, region entrance detection, region exiting detection, unattended baggage detection, object removal detection	Line crossing detection, intrusion detection, region entrance detection, region exiting detection, unattended baggage detection, object removal detection	Line crossing detection, intrusion detection, region entrance detection, region exiting detection, unattended baggage detection, object removal detection
Frame Rate	50Hz: 50fps (1920 × 1080, 1280 × 960, 1280 × 720) 60Hz: 60fps (1920 × 1080, 1280 × 960, 1280 × 720)	50 Hz: 25 fps (2688 × 1520, 2304 × 1296, 1920 × 1080, 1280 × 720) 60 Hz: 30 fps (2688 × 1520, 2304 × 1296, 1920 × 1080, 1280 × 720)	50 Hz: 20fps (3840 × 2160, 3072 × 1728), 25fps (2688 × 1520, 1920 × 1080, 1280 × 720) 60 Hz: 20fps (3840 × 2160, 3072 × 1728), 30 fps (2688 × 1520, 1920 × 1080, 1280 × 720)
Multi-Streaming	3	3	3
Protection Level	IP67	IP67	IP67
Angle Adjustment	-	-	-
Operating Temperature	-	-	-
Operating Humidity	-	-	-
Local Storage	256 GB	256 GB	256 GB
Audio I/O	-	-	-
Alarm I/O	1 in, 1 out	1 in, 1 out	1 in, 1 out
Installation	Outdoor	Outdoor	Outdoor
Power Supply	AC: 24V±20%; PoE: 802.3at	AC: 24V±20%; PoE: 802.3at	AC: 24V±20%; PoE: 802.3at

Model	DS-2DT6223-AELY	DS-2DT6223W-AELY
Image	 DarkFighter NEMA 4X	 DarkFighter NEMA 4X NEW
Image Sensor	1/1.8" Progressive Scan CMOS	1/1.8" Progressive Scan CMOS
Max. Resolution	1920 × 1080	1920 × 1080
Video Compression	H.264 / MJPEG / MPEG4	H.265+ / H.265 / H.264+ / H.264 / MJPEG
Min. Illumination	Color: 0.002 lux @ (F1.5, AGC ON)	Color: 0.005 lux @ (F1.5, AGC ON)
WDR	120 dB	120 dB
Lens	5.9 to 135.7 mm, 23 x optical	5.9 to 135.7 mm, 23x optical
FOV	58.7° to 3.0° (Wide-Tele)	59.8° to 3.0° (wide-tele)
Max. IR Range	-	-
VCA	Face detection, Intrusion detection, Line crossing detection, Audio exception detection, Region entrance detection, Region exiting detection, Smart tracking 1.0	Face detection, Intrusion detection, Line crossing detection, Audio exception detection, Region entrance detection, Region exiting detection, Smart tracking 1.0
Frame Rate	50Hz: 25fps (1920×1080, 1280×960, 1280×720); 60Hz: 30fps(1920×1080, 1280×960, 1280×720)	50Hz: 25fps (1920 × 1080, 1280 × 960, 1280 × 720) 50fps (1920 × 1080, 1280 × 960, 1280 × 720) 60Hz: 30fps (1920 × 1080, 1280 × 960, 1280 × 720) 60fps (1920 × 1080, 1280 × 960, 1280 × 720)
Multi-Streaming	3	3
Protection Level	IP67, IK10	IP67, IK10
Operating Temperature	-40° C to 65° C (-40° F to 149° F)	-40° C to 70° C (-40° F to 158° F)
Operating Humidity	≤ 95%	≤ 95%
Local Storage	256 GB	256 GB
Audio I/O	1/1	1/1
Alarm I/O	7/2	7/2
Installation	Outdoor	Outdoor
Power Supply	24 VAC & Hi-PoE, Max. 60 W	24 VAC & Hi-PoE, Max. 60 W

NVR

056 DeepinMind Series

061 Ultra Series

065 Pro Series

069 Workstation Series







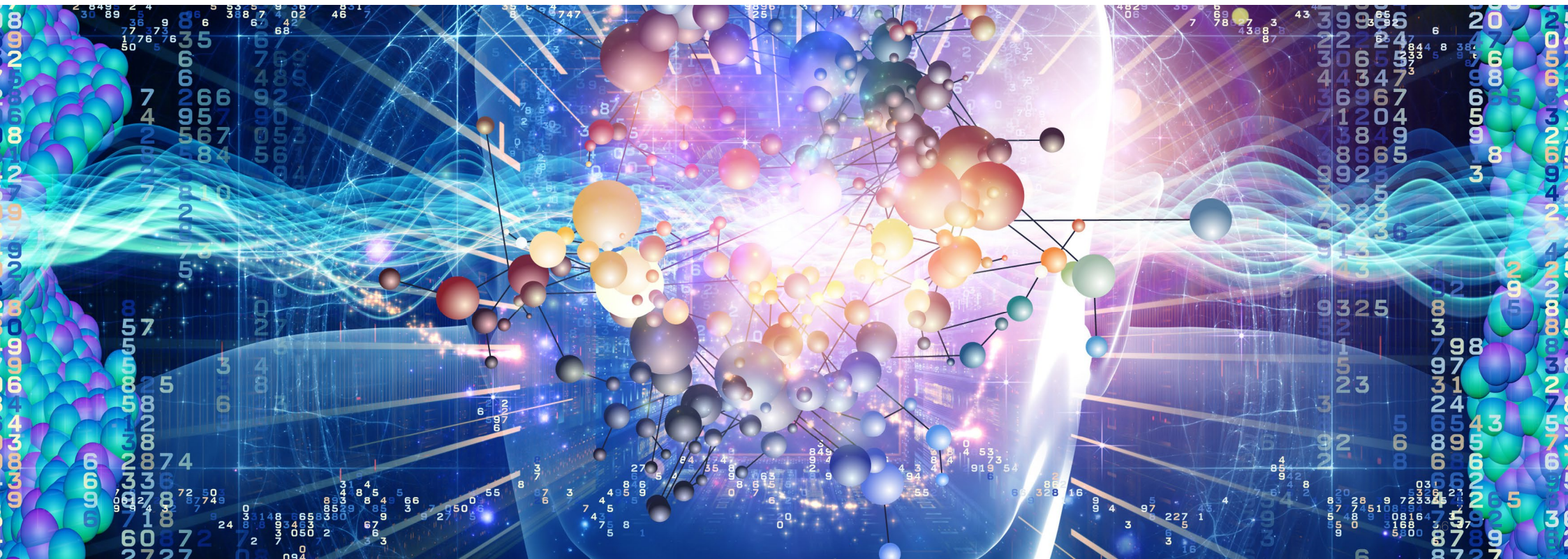

DeepinMind Series NVR

Deeper Intelligence for Expansive Security

- › The first Deep Learning NVR in the industry
- › GPU-based designs
- › Intelligent analytics and advanced storage in one
- › Fast and accurate facial, human body, vehicle, and behavior recognition, and perimeter protection







Model	IDS-96128NXI-I16(B)	IDS-96064NXI-I16(B)	IDS-9632NXI-I8/X(B)	IDS-9632NXI-I8/16S(B)	IDS-9616NXI-I8/X(B)	IDS-9616NXI-I8/16S(B)
Image	 DeepinMind	 DeepinMind	 DeepinMind	 DeepinMind	 DeepinMind	 DeepinMind
Hardware Platform	Intel Xeon E3 Quad-Core processor	Intel Xeon E3 Quad-Core processor	Quad-core embedded processor	Quad-core embedded processor	Quad-core embedded processor	Quad-core embedded processor
No. of Channels	128-ch	64-ch	32-ch	32-ch	16-ch	16-ch
Decoding Format	H.265+ / H.265 / H.264+ / H.264 / MJPEG / MPEG4	H.265+ / H.265 / H.264+ / H.264 / MJPEG / MPEG4	H.265 / H.265+ / H.264 / H.264+ / MPEG4	H.265 / H.265+ / H.264 / H.264+ / MPEG4	H.265 / H.265+ / H.264 / H.264+ / MPEG4	H.265 / H.265+ / H.264 / H.264+ / MPEG4
Incoming/Outgoing Bandwidth	512 Mbps / 512 Mbps	400 Mbps / 400 Mbps	RAID enabled: 200 Mbps/200 Mbps RAID disabled: 320 Mbps/256 Mbps	RAID enabled: 200 Mbps/200 Mbps RAID disabled: 320 Mbps/256 Mbps	RAID enabled: 200 Mbps/200 Mbps RAID disabled: 320 Mbps/256 Mbps	RAID enabled: 200 Mbps/200 Mbps RAID disabled: 320 Mbps/256 Mbps
Decoding Capacity	5-ch @ 8 MP / 10-ch @ 4 MP / 20-ch @ 1080p / 40-ch @ 720p	5-ch @ 8 MP / 10-ch @ 4 MP / 20-ch @ 1080p / 40-ch @ 720p	16-ch @ 1080p (30 fps)	16-ch @ 1080p (30 fps)	16-ch @ 1080p (30 fps)	16-ch @ 1080p (30 fps)
Recording Resolution	12 MP / 8 MP / 6 MP / 5 MP / 4 MP / 3 MP / 1080p / UXGA / 720p / VGA / 4CIF / DCIF / 2CIF / CIF / QCIF	12 MP / 8 MP / 6 MP / 5 MP / 4 MP / 3 MP / 1080p / UXGA / 720p / VGA / 4CIF / DCIF / 2CIF / CIF / QCIF	12 MP / 8 MP / 6 MP / 5 MP / 4 MP / 3 MP / 1080p / UXGA / 720p / VGA / 4CIF / DCIF / 2CIF / CIF / QCIF	12 MP / 8 MP / 6 MP / 5 MP / 4 MP / 3 MP / 1080p / UXGA / 720p / VGA / 4CIF / DCIF / 2CIF / CIF / QCIF	12 MP / 8 MP / 6 MP / 5 MP / 4 MP / 3 MP / 1080p / UXGA / 720p / VGA / 4CIF / DCIF / 2CIF / CIF / QCIF	12 MP / 8 MP / 6 MP / 5 MP / 4 MP / 3 MP / 1080p / UXGA / 720p / VGA / 4CIF / DCIF / 2CIF / CIF / QCIF
Display LCD	2 HDMI / 1 VGA 7-inch LCD	2 HDMI / 1 VGA -	2 HDMI / 2 VGA -	2 HDMI / 2 VGA -	2 HDMI / 2 VGA -	2 HDMI / 2 VGA -
Storage Capacity	16 SATA interfaces supporting hot-plug Up to 10 TB capacity for each HDD	16 SATA interfaces supporting hot-plug Up to 10 TB capacity for each HDD	8 SATA interfaces Up to 10 TB capacity for each HDD	8 SATA interfaces Up to 10 TB capacity for each HDD	8 SATA interfaces Up to 10 TB capacity for each HDD	8 SATA interfaces Up to 10 TB capacity for each HDD
eSATA / Mini SAS	1 eSATA interface / 2 mini SAS interfaces	1 eSATA interface	1 eSATA interface	1 eSATA interface	1 eSATA interface	1 eSATA interface
RAID Type	RAID0, RAID1, RAID5, RAID6, RAID10	RAID0, RAID1, RAID5, RAID6, RAID10	RAID0, RAID1, RAID5, RAID6, RAID10	RAID0, RAID1, RAID5, RAID6, RAID10	RAID0, RAID1, RAID5, RAID6, RAID10	RAID0, RAID1, RAID5, RAID6, RAID10
Video Output	VGA: 1-ch, 1920 × 1080/60Hz, 1600 × 1200/60Hz, 1280 × 1024/60Hz, 1280 × 720/60Hz, 1024 × 768/60Hz HDMI: 2-ch independent HDMI interface, 4K (4096 × 2160)/30Hz, 4K (3840 × 2160)/30Hz, 2K (2560 × 1440)/60Hz, 1920 × 1080/60Hz, 1600 × 1200/60Hz, 1280 × 1024/60Hz, 1280 × 720/60Hz, 1024 × 768/60Hz	VGA: 1-ch, 1920 × 1080/60Hz, 1600 × 1200/60Hz, 1280 × 1024/60Hz, 1280 × 720/60Hz, 1024 × 768/60Hz HDMI: 2-ch independent HDMI interface, 4K (4096 × 2160)/30Hz, 4K (3840 × 2160)/30Hz, 2K (2560 × 1440)/60Hz, 1920 × 1080/60Hz, 1600 × 1200/60Hz, 1280 × 1024/60Hz, 1280 × 720/60Hz, 1024 × 768/60Hz	VGA1: 1920 × 1080/60Hz, 1280 × 1024/60Hz, 1280 × 720/60Hz, 1024 × 768/60Hz HDMI1: 4K (3840 × 2160)/60Hz, 4K (3840 × 2160)/30Hz, 2K (2560 × 1440)/60Hz, 1920 × 1080/60Hz, 1600 × 1200/60Hz, 1280 × 1024/60Hz, 1280 × 720/60Hz, 1024 × 768/60Hz VGA2/HDMI2: 1920 × 1080/60Hz, 1280 × 1024/60Hz, 1280 × 720/60Hz, 1024 × 768/60Hz	VGA1: 1920 × 1080/60Hz, 1280 × 1024/60Hz, 1280 × 720/60Hz, 1024 × 768/60Hz HDMI1: 4K (3840 × 2160)/60Hz, 4K (3840 × 2160)/30Hz, 2K (2560 × 1440)/60Hz, 1920 × 1080/60Hz, 1600 × 1200/60Hz, 1280 × 1024/60Hz, 1280 × 720/60Hz, 1024 × 768/60Hz VGA2/HDMI2: 1920 × 1080/60Hz, 1280 × 1024/60Hz, 1280 × 720/60Hz, 1024 × 768/60Hz	VGA1: 1920 × 1080/60Hz, 1280 × 1024/60Hz, 1280 × 720/60Hz, 1024 × 768/60Hz HDMI1: 4K (3840 × 2160)/60Hz, 4K (3840 × 2160)/30Hz, 2K (2560 × 1440)/60Hz, 1920 × 1080/60Hz, 1600 × 1200/60Hz, 1280 × 1024/60Hz, 1280 × 720/60Hz, 1024 × 768/60Hz VGA2/HDMI2: 1920 × 1080/60Hz, 1280 × 1024/60Hz, 1280 × 720/60Hz, 1024 × 768/60Hz	VGA1: 1920 × 1080/60Hz, 1280 × 1024/60Hz, 1280 × 720/60Hz, 1024 × 768/60Hz HDMI1: 4K (3840 × 2160)/60Hz, 4K (3840 × 2160)/30Hz, 2K (2560 × 1440)/60Hz, 1920 × 1080/60Hz, 1600 × 1200/60Hz, 1280 × 1024/60Hz, 1280 × 720/60Hz, 1024 × 768/60Hz VGA2/HDMI2: 1920 × 1080/60Hz, 1280 × 1024/60Hz, 1280 × 720/60Hz, 1024 × 768/60Hz
Audio Output	1-ch, RCA (2.0 Vp-p, 1 KΩ)	1-ch, RCA (2.0 Vp-p, 1 KΩ)	2-ch, RCA (Linear, 1 KΩ)	2-ch, RCA (Linear, 1 KΩ)	2-ch, RCA (Linear, 1 KΩ)	2-ch, RCA (Linear, 1 KΩ)
Alarm I/O	16/8	16/8	16/4 (16/8 is optional)	16/4 (16/8 is optional)	16/4 (16/8 is optional)	16/4 (16/8 is optional)
Network Interface	4, RJ-45 10/100/1000 Mbps self-adaptive Ethernet interface	4, RJ-45 10/100/1000 Mbps self-adaptive Ethernet interface	2, RJ-45 10/100/1000 Mbps self-adaptive Ethernet interface	2, RJ-45 10/100/1000 Mbps self-adaptive Ethernet interface	2, RJ-45 10/100/1000 Mbps self-adaptive Ethernet interface	2, RJ-45 10/100/1000 Mbps self-adaptive Ethernet interface
PoE Port	-	-	-	-	-	-
USB Port	Front panel: 2 × USB 2.0; Rear panel: 2 × USB 3.0	Front panel: 2 × USB 2.0; Rear panel: 2 × USB 3.0	Front panel: 2 × USB 2.0; Rear panel: 1 × USB 3.0	Front panel: 2 × USB 2.0; Rear panel: 1 × USB 3.0	Front panel: 2 × USB 2.0; Rear panel: 1 × USB 3.0	Front panel: 2 × USB 2.0; Rear panel: 1 × USB 3.0
Smart Function	Deep Learning based video analytics for false alarm reduction, facial recognition and face picture comparison; VCA search for facial detection, false alarm reduction Video Structuralization	Deep Learning based video analytics for false alarm reduction, facial recognition and face picture comparison; VCA search for facial detection, false alarm reduction Video Structuralization	Deep Learning based video analytics for false alarm reduction, facial recognition and face picture comparison; VCA search for facial detection, false alarm reduction Video Structuralization	Deep Learning based video analytics for false alarm reduction; VCA search for false alarm reduction	Deep Learning based video analytics for false alarm reduction, facial recognition and face picture comparison; VCA search for facial detection, false alarm reduction Video Structuralization	Deep Learning based video analytics for false alarm reduction; VCA search for false alarm reduction
Power Consumption (without HDD)	≤ 140 W	≤ 140 W	≤ 70 W	≤ 70 W	≤ 70 W	≤ 70 W
Description	64 libraries with 500,000 face pictures in total Face picture comparison and alarm linkage actions for up to 48 channels False alarm reduction for up to 96 channels Up to 24-ch 2MP Video Structuralization	64 libraries with 500,000 face pictures in total Face picture comparison and alarm linkage actions for up to 24 channels False alarm reduction for up to 48 channels Up to 12-ch 2MP Video Structuralization	32 libraries with 100,000 face pictures in total Face picture comparison and alarm linkage actions for up to 16 channels Up to 16-ch 2 MP video analysis for human and vehicle recognition to reduce false alarms Up to 4-ch 2MP Video Structuralization	Up to 16-ch 2 MP video analysis for human and vehicle recognition to reduce false alarms	32 libraries with 100,000 face pictures in total Face picture comparison and alarm linkage actions for up to 16 channels Up to 16-ch 2 MP video analysis for human and vehicle recognition to reduce false alarms Up to 4-ch 2MP Video Structuralization	Up to 16-ch 2 MP video analysis for human and vehicle recognition to reduce false alarms

Model	IDS-9632NXI-I8/BA
Image	 DeepinMind
Hardware Platform	Quad-core embedded processor
No. of Channels	32-ch
Decoding Format	H.265 / H.265+ / H.264 / H.264+ / MPEG4
Incoming/Outgoing Bandwidth	RAID enabled: 200 Mbps/200 Mbps RAID disabled: 320 Mbps/256 Mbps
Decoding Capacity	16-ch @ 1080p (30 fps)
Recording Resolution	12 MP / 8 MP / 6 MP / 5 MP / 4 MP / 3 MP / 1080p / UXGA / 720p / VGA / 4CIF / DCIF / 2CIF / CIF / QCIF
Display LCD	2 HDMI / 2 VGA -
Storage Capacity	8 SATA interfaces Up to 10 TB capacity for each HDD
eSATA / Mini SAS RAID Type	1 eSATA interface RAID0, RAID1, RAID5, RAID6, RAID10
Video Output	VGA1: 1920 × 1080/60Hz, 1280 × 1024/60Hz, 1280 × 720/60Hz, 1024 × 768/60Hz HDMI1: 4K (3840 × 2160)/60Hz, 4K (3840 × 2160)/30Hz, 2K (2560 × 1440)/60Hz, 1920 × 1080/60Hz, 1600 × 1200/60Hz, 1280 × 1024/60Hz, 1280 × 720/60Hz, 1024 × 768/60Hz VGA2/HDMI2: 1920 × 1080/60Hz, 1280 × 1024/60Hz, 1280 × 720/60Hz, 1024 × 768/60Hz
Audio Output	2-ch, RCA (Linear, 1 KΩ)
Alarm I/O	16/4 (16/8 is optional)
Network Interface	2, RJ-45 10/100/1000 Mbps self-adaptive Ethernet interface
PoE Port	-
USB Port	Front panel: 2 × USB 2.0; Rear panel: 1 × USB 3.0
Smart Function	Deep Learning based video analytics for not wearing hard hat detection and behavior analysis, including people running detection, people gathering detection, violent motion detection, using mobile phone detection, etc.
Power Consumption (without HDD)	≤ 70 W
Description	Up to 4-ch, facial recognition is supported for people not wearing hard hat; Up to 4-ch, including absence/sleep on duty detection people overstay detection, number of people exception detection, and using mobile phone detection; Up to 4-ch, including people gathering detection, people running detection, violent motion detection and people falling down detection; Up to 4-ch, including line crossing detection, intrusion detection, region entrance detection, and region exiting detection

Model	IDS-7732NXI-I4/X(B)
Image	 DeepinMind
Hardware Platform	Quad-core embedded processor
Channel No.	32-ch
Decoding Format	H.265 / H.265+ / H.264 / H.264+ / MPEG4
Incoming/Outgoing Bandwidth	320 Mbps / 256 Mbps
Decoding Capacity	16-ch @ 1080p (30 fps)
Recording Resolution	12 MP / 8 MP / 6 MP / 5 MP / 4 MP / 3MP / 1080p / UXGA / 720p / VGA / 4CIF / DCIF / 2CIF / CIF / QCIF
Display LCD	2 HDMI / 1 VGA -
Storage Capacity	4 SATA interfaces Up to 10 TB capacity for each HDD
eSATA / Mini SAS RAID Type	1 eSATA interface -
Video Output	VGA: 1920 × 1080/60Hz, 1280 × 1024/60Hz, 1280 × 720/60Hz, 1024 × 768/60Hz, HDMI1/VGA Simultaneous Output HDMI1: 4K (3840 × 2160)/60Hz, 4K (3840 × 2160)/30Hz, 2K (2560 × 1440)/60Hz, 1920 × 1080/60Hz, 1600 × 1200/60Hz, 1280 × 1024/60Hz, 1280 × 720/60Hz, 1024 × 768/60Hz HDMI2: 1920 × 1080/60Hz, 1280 × 1024/60Hz, 1280 × 720/60Hz, 1024 × 768/60Hz
Audio Output	1-ch, RCA (Linear, 1 KΩ)
Alarm I/O	16/8
Network Interface	2, RJ-45 10/100/1000 Mbps self-adaptive Ethernet interface
PoE Port	-
USB Port	Front panel: 2 × USB 2.0; Rear panel: 1 × USB 3.0
Smart Function	Deep Learning based video analytics for false alarm reduction, facial recognition and face picture comparison; VCA search for facial detection, false alarm reduction; Video Structuralization"
Power Consumption (without HDD)	≤ 30 W
Description	32 libraries with 100,000 face pictures in total Face picture comparison and alarm linkage actions for up to 16 channels Up to 16-ch 2 MP video analysis for human and vehicle recognition to reduce false alarms Up to 4-ch 2MP Video Structuralization



Model	IDS-7732NXI-I4/16P/X(B)
Image	 DeepinMind
Hardware Platform	Quad-core embedded processor
Channel No.	32-ch
Decoding Format	H.265 / H.265+ / H.264 / H.264+ / MPEG4
Incoming/Outgoing Bandwidth	320 Mbps / 256 Mbps
Decoding Capacity	16-ch @ 1080p (30 fps)
Recording Resolution	12 MP / 8 MP / 6 MP / 5 MP / 4 MP / 3MP / 1080p / UXGA / 720p / VGA / 4CIF / DCIF / 2CIF / CIF / QCIF
Display LCD	2 HDMI / 1 VGA -
Storage Capacity	4 SATA interfaces Up to 10 TB capacity for each HDD
eSATA / Mini SAS RAID Type	1 eSATA interface -
Video Output	VGA: 1920 × 1080/60Hz, 1280 × 1024/60Hz, 1280 × 720/60Hz, 1024 × 768/60Hz, HDMI1/VGA Simultaneous Output HDMI1: 4K (3840 × 2160)/60Hz, 4K (3840 × 2160)/30Hz, 2K (2560 × 1440)/60Hz, 1920 × 1080/60Hz, 1600 × 1200/60Hz, 1280 × 1024/60Hz, 1280 × 720/60Hz, 1024 × 768/60Hz HDMI2: 1920 × 1080/60Hz, 1280 × 1024/60Hz, 1280 × 720/60Hz, 1024 × 768/60Hz
Audio Output	1-ch, RCA (Linear, 1 KΩ)
Alarm I/O	16/8
Network Interface	2, RJ-45 10/100/1000 Mbps self-adaptive Ethernet interface
PoE Port	16 RJ-45 10/100 Mbps self-adaptive Ethernet interfaces
USB Port	Front panel: 2 × USB 2.0; Rear panel: 1 × USB 3.0
Smart Function	Deep Learning based video analytics for false alarm reduction, facial recognition and face picture comparison; VCA search for facial detection, false alarm reduction; Video Structuralization"
Power Consumption (without HDD)	≤ 30 W
Description	32 libraries with 100,000 face pictures in total Face picture comparison and alarm linkage actions for up to 16 channels Up to 16-ch 2 MP video analysis for human and vehicle recognition to reduce false alarms Up to 4-ch 2MP Video Structuralization

Model	IDS-7716NXI-I4/X(B)
Image	 DeepinMind
Hardware Platform	Quad-core embedded processor
Channel No.	16-ch
Decoding Format	H.265 / H.265+ / H.264 / H.264+ / MPEG4
Incoming/Outgoing Bandwidth	320 Mbps / 256 Mbps
Decoding Capacity	16-ch @ 1080p (30 fps)
Recording Resolution	12 MP / 8 MP / 6 MP / 5 MP / 4 MP / 3MP / 1080p / UXGA / 720p / VGA / 4CIF / DCIF / 2CIF / CIF / QCIF
Display LCD	2 HDMI / 1 VGA -
Storage Capacity	4 SATA interfaces Up to 10 TB capacity for each HDD
eSATA / Mini SAS RAID Type	1 eSATA interface -
Video Output	VGA: 1920 × 1080/60Hz, 1280 × 1024/60Hz, 1280 × 720/60Hz, 1024 × 768/60Hz, HDMI1/VGA Simultaneous Output HDMI1: 4K (3840 × 2160)/60Hz, 4K (3840 × 2160)/30Hz, 2K (2560 × 1440)/60Hz, 1920 × 1080/60Hz, 1600 × 1200/60Hz, 1280 × 1024/60Hz, 1280 × 720/60Hz, 1024 × 768/60Hz HDMI2: 1920 × 1080/60Hz, 1280 × 1024/60Hz, 1280 × 720/60Hz, 1024 × 768/60Hz
Audio Output	1-ch, RCA (Linear, 1 KΩ)
Alarm I/O	16/8
Network Interface	2, RJ-45 10/100/1000 Mbps self-adaptive Ethernet interface
PoE Port	-
USB Port	Front panel: 2 × USB 2.0; Rear panel: 1 × USB 3.0
Smart Function	Deep Learning based video analytics for false alarm reduction, facial recognition and face picture comparison; VCA search for facial detection, false alarm reduction; Video Structuralization"
Power Consumption (without HDD)	≤ 30 W
Description	32 libraries with 100,000 face pictures in total Face picture comparison and alarm linkage actions for up to 16 channels Up to 16-ch 2 MP video analysis for human and vehicle recognition to reduce false alarms Up to 4-ch 2MP Video Structuralization

Model	IDS-7732NXI-I4/16P/16S(B)	IDS-7732NXI-I4/16S(B)	IDS-7716NXI-I4/16P/16S(B)	IDS-7716NXI-I4/16S(B)
Image	 DeepinMind	 DeepinMind	 DeepinMind	 DeepinMind
Hardware Platform	Quad-core embedded processor	Quad-core embedded processor	Quad-core embedded processor	Quad-core embedded processor
Channel No.	32-ch	32-ch	16-ch	16-ch
Decoding Format	H.265 / H.265+ / H.264 / H.264+ / MPEG4	H.265 / H.265+ / H.264 / H.264+ / MPEG4	H.265 / H.265+ / H.264 / H.264+ / MPEG4	H.265 / H.265+ / H.264 / H.264+ / MPEG4
Incoming/Outgoing Bandwidth	320 Mbps / 256 Mbps	320 Mbps / 256 Mbps	320 Mbps / 256 Mbps	320 Mbps / 256 Mbps
Decoding Capacity	16-ch @ 1080p (30 fps)	16-ch @ 1080p (30 fps)	16-ch @ 1080p (30 fps)	16-ch @ 1080p (30 fps)
Recording Resolution	12 MP / 8 MP / 6 MP / 5 MP / 4 MP / 3 MP / 1080p / UXGA / 720p / VGA / 4CIF / DCIF / 2CIF / CIF / QCIF	12 MP / 8 MP / 6 MP / 5 MP / 4 MP / 3 MP / 1080p / UXGA / 720p / VGA / 4CIF / DCIF / 2CIF / CIF / QCIF	12 MP / 8 MP / 6 MP / 5 MP / 4 MP / 3 MP / 1080p / UXGA / 720p / VGA / 4CIF / DCIF / 2CIF / CIF / QCIF	12 MP / 8 MP / 6 MP / 5 MP / 4 MP / 3 MP / 1080p / UXGA / 720p / VGA / 4CIF / DCIF / 2CIF / CIF / QCIF
Display	2 HDMI / 1 VGA	2 HDMI / 1 VGA	2 HDMI / 1 VGA	2 HDMI / 1 VGA
LCD	-	-	-	-
Storage Capacity	4 SATA interfaces Up to 8 TB capacity for each HDD	4 SATA interfaces Up to 8 TB capacity for each HDD	4 SATA interfaces Up to 8 TB capacity for each HDD	4 SATA interfaces Up to 8 TB capacity for each HDD
eSATA / Mini SAS	1 eSATA interface	1 eSATA interface	1 eSATA interface	1 eSATA interface
RAID Type	-	-	-	-
Video Output	VGA:1920 × 1080/60Hz, 1280 × 1024/60Hz, 1280 × 720/60Hz, 1024 × 768/60Hz, HDMI1/VGA Simultaneous Output HDMI1:4K (3840 × 2160)/60Hz, 4K (3840 × 2160)/30Hz, 2K (2560 × 1440)/60Hz, 1920 × 1080/60Hz, 1600 × 1200/60Hz, 1280 × 1024/60Hz, 1280 × 720/60Hz, 1024 × 768/60Hz HDMI2:1920 × 1080/60Hz, 1280 × 1024/60Hz, 1280 × 720/60Hz, 1024 × 768/60Hz	VGA:1920 × 1080/60Hz, 1280 × 1024/60Hz, 1280 × 720/60Hz, 1024 × 768/60Hz, HDMI1/VGA Simultaneous Output HDMI1:4K (3840 × 2160)/60Hz, 4K (3840 × 2160)/30Hz, 2K (2560 × 1440)/60Hz, 1920 × 1080/60Hz, 1600 × 1200/60Hz, 1280 × 1024/60Hz, 1280 × 720/60Hz, 1024 × 768/60Hz HDMI2:1920 × 1080/60Hz, 1280 × 1024/60Hz, 1280 × 720/60Hz, 1024 × 768/60Hz	VGA:1920 × 1080/60Hz, 1280 × 1024/60Hz, 1280 × 720/60Hz, 1024 × 768/60Hz, HDMI1/VGA Simultaneous Output HDMI1:4K (3840 × 2160)/60Hz, 4K (3840 × 2160)/30Hz, 2K (2560 × 1440)/60Hz, 1920 × 1080/60Hz, 1600 × 1200/60Hz, 1280 × 1024/60Hz, 1280 × 720/60Hz, 1024 × 768/60Hz HDMI2:1920 × 1080/60Hz, 1280 × 1024/60Hz, 1280 × 720/60Hz, 1024 × 768/60Hz	VGA:1920 × 1080/60Hz, 1280 × 1024/60Hz, 1280 × 720/60Hz, 1024 × 768/60Hz, HDMI1/VGA Simultaneous Output HDMI1:4K (3840 × 2160)/60Hz, 4K (3840 × 2160)/30Hz, 2K (2560 × 1440)/60Hz, 1920 × 1080/60Hz, 1600 × 1200/60Hz, 1280 × 1024/60Hz, 1280 × 720/60Hz, 1024 × 768/60Hz HDMI2:1920 × 1080/60Hz, 1280 × 1024/60Hz, 1280 × 720/60Hz, 1024 × 768/60Hz
Audio Output	1-ch, RCA (Linear, 1 KΩ)	1-ch, RCA (Linear, 1 KΩ)	1-ch, RCA (Linear, 1 KΩ)	1-ch, RCA (Linear, 1 KΩ)
Alarm I/O	16/8	16/8	16/8	16/8
Network Interface	1, RJ-45 10/100/1000 Mbps self-adaptive Ethernet interface	2, RJ-45 10/100/1000 Mbps self-adaptive Ethernet interface	1, RJ-45 10/100/1000 Mbps self-adaptive Ethernet interface	2, RJ-45 10/100/1000 Mbps self-adaptive Ethernet interface
PoE Port	16 RJ-45 10/100 Mbps self-adaptive Ethernet interfaces	-	16 RJ-45 10/100 Mbps self-adaptive Ethernet interfaces	-
USB Port	Front panel: 2 × USB 2.0; Rear panel: 1 × USB 3.0	Front panel: 2 × USB 2.0; Rear panel: 1 × USB 3.0	Front panel: 2 × USB 2.0; Rear panel: 1 × USB 3.0	Front panel: 2 × USB 2.0; Rear panel: 1 × USB 3.0
Smart Function	Deep Learning based video analytics for false alarm reduction; VCA search for false alarm reduction	Deep Learning based video analytics for false alarm reduction; VCA search for false alarm reduction	Deep Learning based video analytics for false alarm reduction; VCA search for false alarm reduction	Deep Learning based video analytics for false alarm reduction; VCA search for false alarm reduction
Power Consumption (without HDD)	≤ 30 W	≤ 30 W	≤ 30 W	≤ 30 W
Description	Up to 16-ch 2 MP video analysis for human and vehicle recognition to reduce false alarms	Up to 16-ch 2 MP video analysis for human and vehicle recognition to reduce false alarms	Up to 16-ch 2 MP video analysis for human and vehicle recognition to reduce false alarms	Up to 16-ch 2 MP video analysis for human and vehicle recognition to reduce false alarms

Model	IDS-7616NXI-I2/8F
Image	 DeepinMind
Hardware Platform	Quad-core embedded processor
Channel No.	16-ch
Decoding Format	H.265 / H.265+ / H.264 / H.264+ / MPEG4
Incoming/Outgoing Bandwidth	160 Mbps / 256 Mbps
Decoding Capacity	16-ch @ 1080p (30 fps)
Recording Resolution	12 MP / 8 MP / 6 MP / 5 MP / 4 MP / 3 MP / 1080p / UXGA / 720p / VGA / 4CIF / DCIF / 2CIF / CIF / QCIF
Display	1 HDMI / 1 VGA / 1 CVBS
LCD	-
Storage Capacity	2 SATA interfaces Up to 6 TB capacity for each HDD
eSATA / Mini SAS	-
RAID Type	-
Video Output	VGA:1-ch, 1920 × 1080/60Hz, 1280 × 1024/60Hz, 1280 × 720/60Hz, 1024 × 768/60Hz, HDMI/VGA independent output HDMI:1-ch, 4K (3840 × 2160)/60Hz, 4K (3840 × 2160)/30Hz, 2K (2560 × 1440)/60Hz, 1920 × 1080/60Hz, 1600 × 1200/60Hz, 1280 × 1024/60Hz, 1280 × 720/60Hz, 1024 × 768/60Hz
Audio Output	1-ch, RCA (Linear, 1 KΩ)
Alarm I/O	4/1
Network Interface	1, RJ-45 10/100/1000 Mbps self-adaptive Ethernet interface
PoE Port	-
USB Port	Front panel: 1 × USB 2.0; Rear panel: 1 × USB 3.0
Smart Function	Deep Learning based video analytics for false alarm reduction, facial recognition and face picture comparison
Power Consumption (without HDD)	≤ 15 W
Description	16 libraries with 100,000 face pictures in total; Face picture comparison and alarm linkage actions for up to 8 channels

Model	IDS-7616NXI-I2/16P/8F	IDS-7608NXI-I2/8F	IDS-7608NXI-I2/8P/8F
Image			
	DeepinMind	DeepinMind	DeepinMind
Hardware Platform	Quad-core embedded processor	Quad-core embedded processor	Quad-core embedded processor
Channel No.	16-ch	8-ch	8-ch
Decoding Format	H.265 / H.265+ / H.264 / H.264+ / MPEG4	H.265 / H.265+ / H.264 / H.264+ / MPEG4	H.265 / H.265+ / H.264 / H.264+ / MPEG4
Incoming/Outgoing Bandwidth	160 Mbps / 256 Mbps	80 Mbps / 256 Mbps	80 Mbps / 256 Mbps
Decoding Capacity	16-ch @ 1080p (30 fps)	16-ch @ 1080p (30 fps)	16-ch @ 1080p (30 fps)
Recording Resolution	12 MP / 8 MP / 6 MP / 5 MP / 4 MP / 3 MP / 1080p / UXGA / 720p / VGA / 4CIF / DCIF / 2CIF / CIF / QCIF	12 MP / 8 MP / 6 MP / 5 MP / 4 MP / 3 MP / 1080p / UXGA / 720p / VGA / 4CIF / DCIF / 2CIF / CIF / QCIF	12 MP / 8 MP / 6 MP / 5 MP / 4 MP / 3 MP / 1080p / UXGA / 720p / VGA / 4CIF / DCIF / 2CIF / CIF / QCIF
Display LCD	1 HDMI / 1 VGA / 1 CVBS	1 HDMI / 1 VGA / 1 CVBS	1 HDMI / 1 VGA / 1 CVBS
Storage Capacity	2 SATA interfaces Up to 6 TB capacity for each HDD	2 SATA interfaces Up to 6 TB capacity for each HDD	2 SATA interfaces Up to 6 TB capacity for each HDD
eSATA / Mini SAS	-	-	-
RAID Type	-	-	-
Video Output	VGA:1-ch, 1920 × 1080/60Hz, 1280 × 1024/60Hz, 1280 × 720/60Hz, 1024 × 768/60Hz, HDMI/VGA independent output HDMI:1-ch, 4K (3840 × 2160)/60Hz, 4K (3840 × 2160)/30Hz, 2K (2560 × 1440)/60Hz, 1920 × 1080/60Hz, 1600 × 1200/60Hz, 1280 × 1024/60Hz, 1280 × 720/60Hz, 1024 × 768/60Hz	VGA:1-ch, 1920 × 1080/60Hz, 1280 × 1024/60Hz, 1280 × 720/60Hz, 1024 × 768/60Hz, HDMI/VGA independent output HDMI:1-ch, 4K (3840 × 2160)/60Hz, 4K (3840 × 2160)/30Hz, 2K (2560 × 1440)/60Hz, 1920 × 1080/60Hz, 1600 × 1200/60Hz, 1280 × 1024/60Hz, 1280 × 720/60Hz, 1024 × 768/60Hz	VGA:1-ch, 1920 × 1080/60Hz, 1280 × 1024/60Hz, 1280 × 720/60Hz, 1024 × 768/60Hz, HDMI/VGA independent output HDMI:1-ch, 4K (3840 × 2160)/60Hz, 4K (3840 × 2160)/30Hz, 2K (2560 × 1440)/60Hz, 1920 × 1080/60Hz, 1600 × 1200/60Hz, 1280 × 1024/60Hz, 1280 × 720/60Hz, 1024 × 768/60Hz
Audio Output	1-ch, RCA (Linear, 1 KΩ)	1-ch, RCA (Linear, 1 KΩ)	1-ch, RCA (Linear, 1 KΩ)
Alarm I/O	4/1	4/1	4/1
Network Interface	1, RJ-45 10/100/1000 Mbps self-adaptive Ethernet interface	1, RJ-45 10/100/1000 Mbps self-adaptive Ethernet interface	1, RJ-45 10/100/1000 Mbps self-adaptive Ethernet interface
PoE Port	16, RJ-45 10/100 Mbps self-adaptive Ethernet interface	-	8, RJ-45 10/100 Mbps self-adaptive Ethernet interface
USB Port	Front panel: 1 × USB 2.0; Rear panel: 1 × USB 3.0	Front panel: 1 × USB 2.0; Rear panel: 1 × USB 3.0	Front panel: 1 × USB 2.0; Rear panel: 1 × USB 3.0
Smart Function	Deep Learning based video analytics for false alarm reduction, facial recognition and face picture comparison	Deep Learning based video analytics for false alarm reduction, facial recognition and face picture comparison	Deep Learning based video analytics for false alarm reduction, facial recognition and face picture comparison
Power Consumption (without HDD)	≤ 15 W	≤ 15 W	≤ 15 W
Description	16 libraries with 100,000 face pictures in total; Face picture comparison and alarm linkage actions for up to 8 channels	16 libraries with 100,000 face pictures in total; Face picture comparison and alarm linkage actions for up to 8 channels	16 libraries with 100,000 face pictures in total; Face picture comparison and alarm linkage actions for up to 8 channels





Model	IDS-6716NXI-I/16S(B)	IDS-6708NXI-I/8F(B)	IDS-6704NXI/BA
Image			
	DeepinMind	DeepinMind	DeepinMind
Hardware Platform	Quad-core embedded processor	Quad-core embedded processor	Quad-core embedded processor
Channel No.	16-ch	8-ch	4-ch
Decoding Format	H.265 / H.265+ / H.264 / H.264+ / MPEG4	H.265 / H.265+ / H.264 / H.264+ / MPEG4	H.265 / H.265+ / H.264 / H.264+ / MPEG4
Incoming/Outgoing Bandwidth	320 Mbps / 250 Mbps	256 Mbps / 200 Mbps	256 Mbps / 200 Mbps
Decoding Capacity	16-ch @ 1080p (30 fps)	16-ch @ 1080p (30 fps)	16-ch @ 1080p (30 fps)
Recording Resolution	12 MP / 8 MP / 6 MP / 5 MP / 4 MP / 3 MP / 1080p / UXGA / 720p / VGA / 4CIF / DCIF / 2CIF / CIF / QCIF	12 MP / 8 MP / 6 MP / 5 MP / 4 MP / 3 MP / 1080p / UXGA / 720p / VGA / 4CIF / DCIF / 2CIF / CIF / QCIF	12 MP / 8 MP / 6 MP / 5 MP / 4 MP / 3 MP / 1080p / UXGA / 720p / VGA / 4CIF / DCIF / 2CIF / CIF / QCIF
Display LCD	-	2 HDMI / 2 VGA	2 HDMI / 2 VGA
Storage Capacity	1 SATA interface built-in 3.5-inch 2 TB SATA hard disk	1 SATA interface built-in 3.5-inch 2 TB SATA hard disk	-
eSATA/Mini SAS	-	-	-
RAID Type	-	-	-
Video Output	-	2 × VGA 2 × HDMI	2 × VGA 2 × HDMI
Audio Output	1-ch, RCA (Linear, 1 KΩ)	1-ch, RCA (Linear, 1 KΩ)	1-ch, RCA (Linear, 1 KΩ)
Alarm I/O	16/4	16/4	16/4
Network Interface	2, RJ-45 10/100/1000 Mbps self-adaptive Ethernet interface	2, RJ-45 10/100/1000 Mbps self-adaptive Ethernet interface	2, RJ-45 10/100/1000 Mbps self-adaptive Ethernet interface
PoE Port	-	-	-
USB Port	-	Rear panel: 1 × USB 3.0, 1 × USB 2.0	Rear panel: 1 × USB 3.0, 1 × USB 2.0
Smart Function	Deep Learning based video analytics for false alarm reduction; VCA search for false alarm reduction	Deep Learning based video analytics for false alarm reduction; VCA search for false alarm reduction	Deep Learning based video analytics for not wearing hard hat detection and behavior analysis, including people running detection, people gathering detection, violent motion detection, using mobile phone detection, etc.
Power Consumption (without HDD)	≤ 30 W	≤ 30 W	≤ 30 W
Description	Up to 16-ch 2 MP video analysis for human and vehicle recognition to reduce false alarms	32 libraries with 100,000 face pictures in total; Face picture comparison and alarm linkage actions for up to 8 channels	Up to 4-ch, facial recognition is supported for people not wearing hard hat 16 libraries 100000 pictures Up to 4-ch, including absence/sleep on duty detection people overstay detection, number of people exception detection, and using mobile phone detection Up to 4-ch, including people gathering detection, people running detection, violent motion detection, and people falling down detection Up to 4-ch, including line crossing detection, intrusion detection, region entrance detection, and region exiting detection



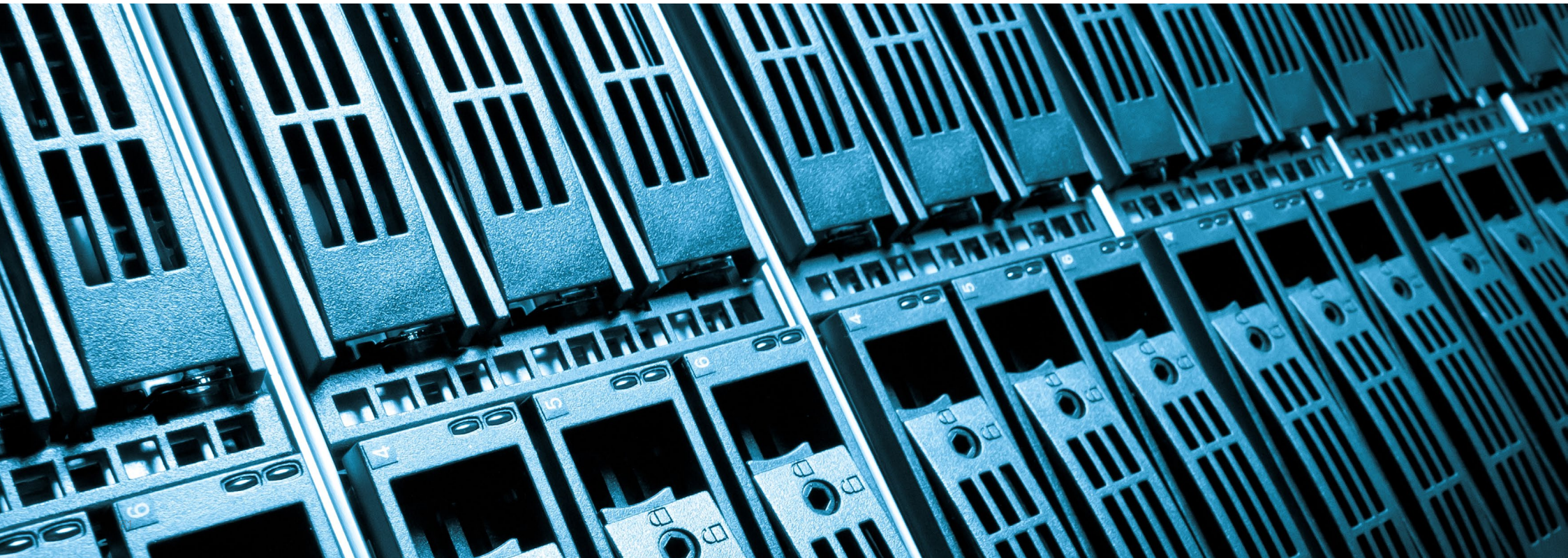



Ultra Series NVR





Superior Storage and Robust Recording

- › H.265+/H.265, H.264+/H.264, MPEG4 self-adapting decoding
- › Supports people counting cameras, automatic number plate recognition (ANPR) cameras, fisheye cameras, and PoS text overlay
- › Advanced streaming technology enables a smooth live feed even under imperfect network conditions
- › Supports RAID 0, 1, 5, 6, 10 and N+1 hot spare for even more reliable data storage, effectively reducing data loss risks
- › Supports IoT systems (CCTV and Non-CCTV convergence)



Model	DS-96256NI-I24/H	DS-96256NI-I24	DS-96128NI-I24/H	DS-96128NI-I24	DS-96256NI-I16
Image					
Hardware Platform	Intel Xeon E3 Quad-Core processor	Intel Xeon E3 Quad-Core processor	Intel Xeon E3 Quad-Core processor	Intel Core I3 Dual-Core processor	Intel Xeon E3 Quad-Core processor
Channel No.	256-ch	256-ch	128-ch	128-ch	256-ch
Decoding Format	H.265, H.265+, H.264, H.264+, MPEG4, MJPEG (for Hikvision IP camera only)	H.265, H.265+, H.264, H.264+, MPEG4, MJPEG (for Hikvision IP camera only)	H.265, H.265+, H.264, H.264+, MPEG4, MJPEG (for Hikvision IP camera only)	H.265, H.265+, H.264, H.264+, MPEG4, MJPEG (for Hikvision IP camera only)	H.265, H.265+, H.264, H.264+, MPEG4, MJPEG (for Hikvision IP camera only)
Incoming/Outgoing Bandwidth	768 Mbps / 768 Mbps 768 Mbps / 768 Mbps (RAID mode)	768 Mbps / 768 Mbps 768 Mbps / 768 Mbps (RAID mode)	768 Mbps / 512 Mbps 768 Mbps / 512 Mbps (RAID mode)	576 Mbps / 512 Mbps 576 Mbps / 512 Mbps (RAID mode)	768 Mbps / 768 Mbps 768 Mbps / 768 Mbps (RAID mode)
Decoding Capacity	20-ch @ 1080p	20-ch @ 1080p	20-ch @ 1080p	20-ch @ 1080p	20-ch @ 1080p
Recording Resolution	32 MP/24 MP/12 MP/8 MP/6 MP/5 MP/4 MP/3 MP/1080p/UXGA/720p/VGA /4CIF/DCIF/2CIF/CIF/QCIF *: 32 MP and 24 MP is only available for channel 1-4 when ultra HD resolution mode is enabled.	32 MP/24 MP/12 MP/8 MP/6 MP/5 MP/4 MP/3 MP/1080p/UXGA/720p/VGA /4CIF/DCIF/2CIF/CIF/QCIF *: 32 MP and 24 MP is only available for channel 1-4 when ultra HD resolution mode is enabled.	32 MP/24 MP/12 MP/8 MP/6 MP/5 MP/4 MP/3 MP/1080p/UXGA/720p/VGA /4CIF/DCIF/2CIF/CIF/QCIF *: 32 MP and 24 MP is only available for channel 1-4 when ultra HD resolution mode is enabled.	32 MP/24 MP/12 MP/8 MP/6 MP/5 MP/4 MP/3 MP/1080p/UXGA/720p/VGA /4CIF/DCIF/2CIF/CIF/QCIF *: 32 MP and 24 MP is only available for channel 1-4 when ultra HD resolution mode is enabled.	32 MP/24 MP/12 MP/8 MP/6 MP/5 MP/4 MP/3 MP/1080p/UXGA/720p/VGA /4CIF/DCIF/2CIF/CIF/QCIF *: 32 MP and 24 MP is only available for channel 1-4 when ultra HD resolution mode is enabled.
Display	2 HDMI / 1 VGA	2 HDMI / 1 VGA	2 HDMI / 1 VGA	2 HDMI / 1 VGA	2 HDMI / 1 VGA
Video Output	HDMI:Two independent HDMI outputs of 4K resolution. Resolution: 4K [4096 × 2160], 4K [3840 × 2160]/30Hz, 2K [2560 × 1440]/60Hz, 1080p [1920 × 1080]/60Hz, UXGA [1600 × 1200]/60Hz, SXGA [1280 × 1024]/60Hz, 720p [1280 × 720]/60Hz, XGA [1024 × 768]/60Hz VGA:1-ch. Resolution: 1080p [1920 × 1080]/60Hz, UXGA [1600 × 1200]/60Hz, SXGA [1280 × 1024]/60Hz, 720p [1280 × 720]/60Hz, XGA [1024 × 768]/60Hz	HDMI:Two independent HDMI outputs of 4K resolution. Resolution: 4K [4096 × 2160], 4K [3840 × 2160]/30Hz, 2K [2560 × 1440]/60Hz, 1080p [1920 × 1080]/60Hz, UXGA [1600 × 1200]/60Hz, SXGA [1280 × 1024]/60Hz, 720p [1280 × 720]/60Hz, XGA [1024 × 768]/60Hz VGA:1-ch. Resolution: 1080p [1920 × 1080]/60Hz, UXGA [1600 × 1200]/60Hz, SXGA [1280 × 1024]/60Hz, 720p [1280 × 720]/60Hz, XGA [1024 × 768]/60Hz	HDMI:Two independent HDMI outputs of 4K resolution. Resolution: 4K [4096 × 2160], 4K [3840 × 2160]/30Hz, 2K [2560 × 1440]/60Hz, 1080p [1920 × 1080]/60Hz, UXGA [1600 × 1200]/60Hz, SXGA [1280 × 1024]/60Hz, 720p [1280 × 720]/60Hz, XGA [1024 × 768]/60Hz VGA:1-ch. Resolution: 1080p [1920 × 1080]/60Hz, UXGA [1600 × 1200]/60Hz, SXGA [1280 × 1024]/60Hz, 720p [1280 × 720]/60Hz, XGA [1024 × 768]/60Hz	HDMI:Two independent HDMI outputs of 4K resolution. Resolution: 4K [4096 × 2160], 4K [3840 × 2160]/30Hz, 2K [2560 × 1440]/60Hz, 1080p [1920 × 1080]/60Hz, UXGA [1600 × 1200]/60Hz, SXGA [1280 × 1024]/60Hz, 720p [1280 × 720]/60Hz, XGA [1024 × 768]/60Hz VGA:1-ch. Resolution: 1080p [1920 × 1080]/60Hz, UXGA [1600 × 1200]/60Hz, SXGA [1280 × 1024]/60Hz, 720p [1280 × 720]/60Hz, XGA [1024 × 768]/60Hz	HDMI:Two independent HDMI outputs of 4K resolution. Resolution: 4K [4096 × 2160], 4K [3840 × 2160]/30Hz, 2K [2560 × 1440]/60Hz, 1080p [1920 × 1080]/60Hz, UXGA [1600 × 1200]/60Hz, SXGA [1280 × 1024]/60Hz, 720p [1280 × 720]/60Hz, XGA [1024 × 768]/60Hz VGA:1-ch. Resolution: 1080p [1920 × 1080]/60Hz, UXGA [1600 × 1200]/60Hz, SXGA [1280 × 1024]/60Hz, 720p [1280 × 720]/60Hz, XGA [1024 × 768]/60Hz
LCD	One 7 inch LCD (Optional)	One 7 inch LCD (Optional)	One 7 inch LCD (Optional)	One 7 inch LCD (Optional)	One 7 inch LCD (Optional)
Storage Capacity	24 SATA interfaces supporting hot-plug Up to 10 TB for each HDD	24 SATA interfaces supporting hot-plug Up to 10 TB for each HDD	24 SATA interfaces supporting hot-plug Up to 10 TB for each HDD	24 SATA interfaces supporting hot-plug Up to 10 TB for each HDD	16 SATA interfaces supporting hot-plug Up to 10 TB for each HDD
eSATA / Mini SAS	1 × eSATA interface, 2 × mini SAS interface (optional)	1 × eSATA interface, 2 × mini SAS interface (optional)	1 × eSATA interface, 2 × mini SAS interface (optional)	1 × eSATA interface, 2 × mini SAS interface (optional)	1 × eSATA interface, 2 × mini SAS interface (optional)
RAID Type	RAID0, RAID1, RAID5, RAID 6, and RAID10	RAID0, RAID1, RAID5, RAID 6, and RAID10	RAID0, RAID1, RAID5, RAID 6, and RAID10	RAID0, RAID1, RAID5, RAID 6, and RAID10	RAID0, RAID1, RAID5, RAID 6, and RAID10
Audio Output	1-ch. RCA [2.0 Vp-p, 1 KΩ]	1-ch. RCA [2.0 Vp-p, 1 KΩ]	1-ch. RCA [2.0 Vp-p, 1 KΩ]	1-ch. RCA [2.0 Vp-p, 1 KΩ]	1-ch. RCA [2.0 Vp-p, 1 KΩ]
Alarm I/O	16/8	16/8	16/8	16/8	16/8
Network Interface	4, RJ45 10M/100M/1000M self-adaptive Ethernet interface	4, RJ45 10M/100M/1000M self-adaptive Ethernet interface	4, RJ45 10M/100M/1000M self-adaptive Ethernet interface	4, RJ45 10M/100M/1000M self-adaptive Ethernet interface	4, RJ45 10M/100M/1000M self-adaptive Ethernet interface
PoE Port	-	-	-	-	-
USB Port	Front Panel: 1 × USB 2.0; Rear Panel: 2 × USB 3.0	Front Panel: 1 × USB 2.0; Rear Panel: 2 × USB 3.0	Front Panel: 1 × USB 2.0; Rear Panel: 2 × USB 3.0	Front Panel: 1 × USB 2.0; Rear Panel: 2 × USB 3.0	Front Panel: 2 × USB 2.0; Rear Panel: 2 × USB 3.0
Smart Function	Face detection, behavior analysis, people counting and heat map	Face detection, behavior analysis, people counting and heat map	Face detection, behavior analysis, people counting and heat map	Face detection, behavior analysis, people counting and heat map	Face detection, behavior analysis, people counting and heat map
Power Consumption (without HDD)	≤ 140W	≤ 140W	≤ 140W	≤ 140W	≤ 140W
Description	-	-	-	-	-

Model	DS-96256NI-I16/H	DS-96128NI-I16	DS-96128NI-I16/H	DS-96064NI-I16	DS-9664NI-I16	DS-9632NI-I16
Image						
Hardware Platform	Intel Xeon E3 Quad-Core processor	Intel Core i3 Dual-Core processor	Intel Core i3 Dual-Core processor	Intel Pentium Dual-Core processor	Quad-core embedded processor	Quad-core embedded processor
Channel No.	256-ch	128-ch	128-ch	64-ch	64-ch	32-ch
Decoding Format	H.265, H.265+, H.264, H.264+, MPEG4, MJPEG (for Hikvision IP camera only)	H.265, H.265+, H.264, H.264+, MPEG4, MJPEG (for Hikvision IP camera only)	H.265, H.265+, H.264, H.264+, MPEG4, MJPEG (for Hikvision IP camera only)	H.265, H.265+, H.264, H.264+, MPEG4, MJPEG (for Hikvision IP camera only)	H.265 / H.265+ / H.264 / H.264+ / MPEG4	H.265+ / H.265+ / H.264 / H.264+ / MPEG4
Incoming/Outgoing Bandwidth	768 Mbps / 768 Mbps 768 Mbps / 768 Mbps (RAID mode)	576 Mbps / 512 Mbps 576 Mbps / 512 Mbps (RAID mode)	768 Mbps / 512 Mbps 768 Mbps / 512 Mbps (RAID mode)	512 Mbps / 512 Mbps 512 Mbps / 400 Mbps (RAID mode)	320 Mbps / 256 Mbps 200 Mbps / 200 Mbps (RAID mode)	320 Mbps / 256 Mbps 200 Mbps / 200 Mbps (RAID mode)
Decoding Capacity	20-ch @ 1080p	20-ch @ 1080p	20-ch @ 1080p	20-ch @ 1080p	2-ch @ 12 MP (20 fps) / 4-ch @ 8 MP (25 fps) / 8-ch @ 4 MP (30 fps) / 16-ch @ 1080p (30 fps)	2-ch @ 12 MP (20 fps) / 4-ch @ 8 MP (25 fps) / 8-ch @ 4 MP (30 fps) / 16-ch @ 1080p (30 fps)
Recording Resolution	32 MP/24 MP/12 MP/8 MP/6 MP/5 MP/4 MP/3 MP/1080p/UXGA/720p/VGA /4CIF/DCIF/2CIF/CIF/QCIF *: 32 MP and 24 MP is only available for channel 1-4 when ultra HD resolution mode is enabled.	32 MP/24 MP/12 MP/8 MP/6 MP/5 MP/4 MP/3 MP/1080p/UXGA/720p/VGA /4CIF/DCIF/2CIF/CIF/QCIF *: 32 MP and 24 MP is only available for channel 1-4 when ultra HD resolution mode is enabled.	32 MP/24 MP/12 MP/8 MP/6 MP/5 MP/4 MP/3 MP/1080p/UXGA/720p/VGA /4CIF/DCIF/2CIF/CIF/QCIF *: 32 MP and 24 MP is only available for channel 1-4 when ultra HD resolution mode is enabled.	32 MP/24 MP/12 MP/8 MP/6 MP/5 MP/4 MP/3 MP/1080p/UXGA/720p/VGA /4CIF/DCIF/2CIF/CIF/QCIF *: 32 MP and 24 MP is only available for channel 1-4 when ultra HD resolution mode is enabled.	32 MP/24 MP/12 MP/8 MP/6 MP/5 MP/4 MP/3 MP/1080p/UXGA/720p/VGA /4CIF/DCIF/2CIF/CIF/QCIF *: 32 MP and 24 MP is only available for channel 1 when ultra HD resolution mode is enabled.	32 MP/24 MP/12 MP/8 MP/6 MP/5 MP/4 MP/3 MP/1080p/UXGA/720p/VGA /4CIF/DCIF/2CIF/CIF/QCIF *: 32 MP and 24 MP is only available for channel 1 when ultra HD resolution mode is enabled.
Display	2 HDMI / 1 VGA	2 HDMI / 1 VGA	2 HDMI / 1 VGA	2 HDMI / 1 VGA	2 HDMI / 2 VGA	2 HDMI / 2 VGA
Video Output	HDMI:Two independent HDMI outputs of 4K resolution. Resolution: 4K (4096 × 2160), 4K (3840 × 2160)/30Hz, 2K (2560 × 1440)/60Hz, 1080p (1920 × 1080)/60Hz, UXGA (1600 × 1200)/60Hz, SXGA (1280 × 1024)/60Hz, 720p (1280 × 720)/60Hz, XGA (1024 × 768)/60Hz VGA:1-ch. Resolution: 1080p (1920 × 1080) /60Hz, UXGA (1600 × 1200) /60Hz, SXGA (1280 × 1024) /60Hz, 720p (1280 × 720) /60Hz, XGA (1024 × 768) /60Hz	HDMI:Two independent HDMI outputs of 4K resolution. Resolution: 4K (4096 × 2160), 4K (3840 × 2160)/30Hz, 2K (2560 × 1440)/60Hz, 1080p (1920 × 1080)/60Hz, UXGA (1600 × 1200)/60Hz, SXGA (1280 × 1024)/60Hz, 720p (1280 × 720)/60Hz, XGA (1024 × 768)/60Hz VGA:1-ch. Resolution: 1080p (1920 × 1080) /60Hz, UXGA (1600 × 1200) /60Hz, SXGA (1280 × 1024) /60Hz, 720p (1280 × 720) /60Hz, XGA (1024 × 768) /60Hz	HDMI:Two independent HDMI outputs of 4K resolution. Resolution: 4K (4096 × 2160), 4K (3840 × 2160)/30Hz, 2K (2560 × 1440)/60Hz, 1080p (1920 × 1080)/60Hz, UXGA (1600 × 1200)/60Hz, SXGA (1280 × 1024)/60Hz, 720p (1280 × 720) /60Hz, XGA (1024 × 768) /60Hz VGA:1-ch. Resolution: 1080p (1920 × 1080) /60Hz, UXGA (1600 × 1200) /60Hz, SXGA (1280 × 1024) /60Hz, 720p (1280 × 720) /60Hz, XGA (1024 × 768) /60Hz	HDMI:Two independent HDMI outputs of 4K resolution. Resolution: 4K (4096 × 2160), 4K (3840 × 2160)/30Hz, 2K (2560 × 1440)/60Hz, 1080p (1920 × 1080)/60Hz, UXGA (1600 × 1200)/60Hz, SXGA (1280 × 1024)/60Hz, 720p (1280 × 720) /60Hz, XGA (1024 × 768) /60Hz VGA:1-ch. Resolution: 1080p (1920 × 1080) /60Hz, UXGA (1600 × 1200) /60Hz, SXGA (1280 × 1024) /60Hz, 720p (1280 × 720) /60Hz, XGA (1024 × 768) /60Hz	VGA1: 2K (2560 × 1440)/60Hz, 1920 × 1080/60Hz, 1280 × 1024/60Hz, 1280 × 2160), 4K (3840 × 2160)/30Hz, 1024 × 768/60Hz HDMI: 4K (3840 × 2160)/60Hz, 4K (3840 × 2160)/30Hz, 2K (2560 × 1440)/60Hz, 1920 × 1080/60Hz, 1600 × 1200/60Hz, 1280 × 1024/60Hz, 1280 × 720/60Hz, 1024 × 768/60Hz VGA2/HDMI2:1920 × 1080/60Hz, 1280 × 1024/60Hz, 1280 × 720/60Hz, 1024 × 768/60Hz	VGA1: 2K (2560 × 1440)/60Hz, 1920 × 1080/60Hz, 1280 × 1024/60Hz, 1280 × 720/60Hz, 1024 × 768/60Hz HDMI: 4K (3840 × 2160)/60Hz, 4K (3840 × 2160)/30Hz, 2K (2560 × 1440)/60Hz, 1920 × 1080/60Hz, 1600 × 1200/60Hz, 1280 × 1024/60Hz, 1280 × 720/60Hz, 1024 × 768/60Hz VGA2/HDMI2:1920 × 1080/60Hz, 1280 × 1024/60Hz, 1280 × 720/60Hz, 1024 × 768/60Hz
LCD	One 7 inch LCD (Optional)	One 7 inch LCD (Optional)	One 7 inch LCD (Optional)	One 7 inch LCD (Optional)	-	-
Storage Capacity	16 SATA interfaces supporting hot-plug Up to 10 TB for each HDD	16 SATA interfaces supporting hot-plug Up to 10 TB for each HDD	16 SATA interfaces supporting hot-plug Up to 10 TB for each HDD	16 SATA interfaces supporting hot-plug Up to 10 TB for each HDD	16 SATA interfaces Up to 10 TB for each HDD	16 SATA interfaces Up to 10 TB for each HDD
eSATA / Mini SAS	1 × eSATA interface, 2 × mini SAS interface (optional)	1 × eSATA interface, 2 × mini SAS interface (optional)	1 × eSATA interface, 2 × mini SAS interface (optional)	1 × eSATA interface, 2 × mini SAS interface (optional)	1 × eSATA interface	1 × eSATA interface
RAID Type	RAID0, RAID1, RAID5, RAID 6, and RAID10	RAID0, RAID1, RAID5, RAID 6, and RAID10	RAID0, RAID1, RAID5, RAID 6, and RAID10	RAID0, RAID1, RAID5, RAID 6, and RAID10	RAID0, RAID1, RAID5, RAID 6, and RAID10	RAID0, RAID1, RAID5, RAID 6, and RAID10
Audio Output	1-ch. RCA (2.0 Vp-p, 1 KΩ)	1-ch. RCA (2.0 Vp-p, 1 KΩ)	1-ch. RCA (2.0 Vp-p, 1 KΩ)	1-ch. RCA (2.0 Vp-p, 1 KΩ)	1-ch. RCA (2.0 Vp-p, 1 KΩ)	1-ch. RCA (2.0 Vp-p, 1 KΩ)
Alarm I/O	16/8	16/8	16/8	16/8	16/8	16/8
Network Interface	4, RJ45 10M/100M/1000M self-adaptive Ethernet interface	4, RJ45 10M/100M/1000M self-adaptive Ethernet interface	4, RJ45 10M/100M/1000M self-adaptive Ethernet interface	4, RJ45 10M/100M/1000M self-adaptive Ethernet interface	2, RJ45 10M/100M/1000M self-adaptive Ethernet interface	2, RJ45 10M/100M/1000M self-adaptive Ethernet interface
PoE Port	-	-	-	-	-	-
USB Port	Front Panel: 2 × USB 2.0; Rear Panel: 2 × USB 3.0	Front Panel: 2 × USB 2.0; Rear Panel: 2 × USB 3.0	Front Panel: 2 × USB 2.0; Rear Panel: 2 × USB 3.0	Front Panel: 2 × USB 2.0; Rear Panel: 2 × USB 3.0	Front Panel: 2 × USB 2.0; Rear Panel: 1 × USB 3.0	Front Panel: 2 × USB 2.0; Rear Panel: 1 × USB 3.0
Smart Function	Face detection, behavior analysis, people counting and heat map	Face detection, behavior analysis, people counting and heat map	Face detection, behavior analysis, people counting and heat map	Face detection, behavior analysis, people counting and heat map	Supports multiple VCA(Video Content Analytics) events for IP cameras	Supports multiple VCA(Video Content Analytics) events for IP cameras
Power Consumption (without HDD)	≤ 140W	≤ 140W	≤ 140W	≤ 140W	≤ 45 W	≤ 45 W
Description	-	-	-	-	-	-



Model	DS-9664NI-I8	DS-9632NI-I8	DS-9616NI-I8	DS-8632NI-K8	DS-8616NI-K8
Image	 HOT	 HOT			
Hardware Platform	Quad-core embedded processor	Quad-core embedded processor	Quad-core embedded processor	Quad-core embedded processor	Quad-core embedded processor
Channel No.	64-ch	32-ch	16-ch	32-ch	16-ch
Decoding Format	H.265 / H.265+ / H.264 / H.264+ / MPEG4	H.265 / H.265+ / H.264 / H.264+ / MPEG4	H.265 / H.265+ / H.264 / H.264+ / MPEG4	H.265 / H.265+ / H.264 / H.264+ / MPEG4	H.265 / H.265+ / H.264 / H.264+ / MPEG4
Incoming/Outgoing Bandwidth	320 Mbps / 256 Mbps 200 Mbps / 200 Mbps (RAID mode)	320 Mbps / 256 Mbps 200 Mbps / 200 Mbps (RAID mode)	256 Mbps / 256 Mbps 200 Mbps / 200 Mbps (RAID mode)	256 Mbps / 160 Mbps	160 Mbps / 160 Mbps
Decoding Capacity	2-ch @ 12 MP (20 fps) / 4-ch @ 8 MP (25 fps) / 8-ch @ 4 MP (30 fps) / 16-ch @ 1080p (30 fps)	2-ch @ 12 MP (20 fps) / 4-ch @ 8 MP (25 fps) / 8-ch @ 4 MP (30 fps) / 16-ch @ 1080p (30 fps)	2-ch @ 12 MP (20 fps) / 4-ch @ 8 MP (25 fps) / 8-ch @ 4 MP (30 fps) / 16-ch @ 1080p (30 fps)	2-ch @ 8 MP (25 fps) / 4-ch @ 4 MP (30 fps) / 8-ch @ 1080p (30 fps)	2-ch @ 8 MP (25 fps) / 4-ch @ 4 MP (30 fps) / 8-ch @ 1080p (30 fps)
Recording Resolution	32 MP/24 MP/12 MP/8 MP/6 MP/5 MP/4 MP/3 MP/1080p/UXGA/720p/VGA /4CIF/DCIF/2CIF/CIF/QCIF *: 32 MP and 24 MP is only available for channel 1 when ultra HD resolution mode is enabled.	32 MP/24 MP/12 MP/8 MP/6 MP/5 MP/4 MP/3 MP/1080p/UXGA/720p/VGA /4CIF/DCIF/2CIF/CIF/QCIF *: 32 MP and 24 MP is only available for channel 1 when ultra HD resolution mode is enabled.	32 MP/24 MP/12 MP/8 MP/6 MP/5 MP/4 MP/3 MP/1080p/UXGA/720p/VGA /4CIF/DCIF/2CIF/CIF/QCIF *: 32 MP and 24 MP is only available for channel 1 when ultra HD resolution mode is enabled.	8 MP / 6 MP / 5 MP / 4 MP / 3 MP / 1080p / UXGA / 720p / VGA / 4CIF / DCIF	8 MP / 6 MP / 5 MP / 4 MP / 3 MP / 1080p / UXGA / 720p / VGA / 4CIF / DCIF
Display	2 HDMI / 2 VGA	2 HDMI / 2 VGA	2 HDMI / 2 VGA	2 HDMI / 2 VGA	2 HDMI / 2 VGA
Video Output	HDMI1: 4K (3840 × 2160)/60Hz, 4K (3840 × 2160)/30Hz, 2K (2560 × 1440)/60Hz, 1920 × 1080p/60Hz, 1600 × 1200/60Hz, 1280 × 1024/60Hz, 1280 × 720/60Hz, 1024 × 768/60Hz VGA1: 2K (2560 × 1440)/60Hz, 1920 × 1080p/60Hz, 1600 × 1200/60Hz, 1280 × 1024/60Hz, 1280 × 720/60Hz, 1024 × 768/60Hz VGA2/HDMI2:1920 × 1080p/60Hz, 1280 × 1024/60Hz, 1280 × 720/60Hz, 1024 × 768/60Hz	HDMI1: 4K (3840 × 2160)/60Hz, 4K (3840 × 2160)/30Hz, 2K (2560 × 1440)/60Hz, 1920 × 1080p/60Hz, 1600 × 1200/60Hz, 1280 × 1024/60Hz, 1280 × 720/60Hz, 1024 × 768/60Hz VGA1: 2K (2560 × 1440)/60Hz, 1920 × 1080p/60Hz, 1600 × 1200/60Hz, 1280 × 1024/60Hz, 1280 × 720/60Hz, 1024 × 768/60Hz VGA2/HDMI2:1920 × 1080p/60Hz, 1280 × 1024/60Hz, 1280 × 720/60Hz, 1024 × 768/60Hz	HDMI1: 4K (3840 × 2160)/60Hz, 4K (3840 × 2160)/30Hz, 2K (2560 × 1440)/60Hz, 1920 × 1080p/60Hz, 1600 × 1200/60Hz, 1280 × 1024/60Hz, 1280 × 720/60Hz, 1024 × 768/60Hz VGA1: 2K (2560 × 1440)/60Hz, 1920 × 1080p/60Hz, 1600 × 1200/60Hz, 1280 × 1024/60Hz, 1280 × 720/60Hz, 1024 × 768/60Hz VGA2/HDMI2:1920 × 1080p/60Hz, 1280 × 1024/60Hz, 1280 × 720/60Hz, 1024 × 768/60Hz	HDMI1: 4K (3840 × 2160)/30Hz, 2K (2560 × 1440)/60Hz, 1920 × 1080/60Hz, 1600 × 1200/60Hz, 1280 × 1024/60Hz, 1280 × 720/60Hz, 1024 × 768/60Hz HDMI2: 1920 × 1080/60Hz, 1280 × 1024/60Hz, 1280 × 720/60Hz, 1024 × 768/60Hz VGA1: 2K (2560 × 1440)/60Hz, 1920 × 1080/60Hz, 1600 × 1200/60Hz, 1280 × 1024/60Hz, 1280 × 720/60Hz, 1024 × 768/60Hz VGA2: 1920 × 1080/60Hz, 1280 × 1024/60Hz, 1280 × 720/60Hz, 1024 × 768/60Hz	HDMI1: 4K (3840 × 2160)/30Hz, 2K (2560 × 1440)/60Hz, 1920 × 1080/60Hz, 1600 × 1200/60Hz, 1280 × 1024/60Hz, 1280 × 720/60Hz, 1024 × 768/60Hz HDMI2: 1920 × 1080/60Hz, 1280 × 1024/60Hz, 1280 × 720/60Hz, 1024 × 768/60Hz VGA1: 2K (2560 × 1440)/60Hz, 1920 × 1080/60Hz, 1600 × 1200/60Hz, 1280 × 1024/60Hz, 1280 × 720/60Hz, 1024 × 768/60Hz VGA2: 1920 × 1080/60Hz, 1280 × 1024/60Hz, 1280 × 720/60Hz, 1024 × 768/60Hz
LCD	-	-	-	-	-
Storage Capacity	8 SATA interfaces Up to 10 TB for each HDD	8 SATA interfaces Up to 10 TB for each HDD	8 SATA interfaces Up to 10 TB for each HDD	8 SATA interfaces Up to 6TB capacity for each HDD	8 SATA interfaces Up to 6TB capacity for each HDD
eSATA / Mini SAS	1 eSATA interface	1 eSATA interface	1 eSATA interface	1 eSATA interface	1 eSATA interface
RAID Type	RAIDO, RAID1, RAID5, RAID 6, RAID10	RAIDO, RAID1, RAID5, RAID6, RAID10	RAIDO, RAID1, RAID5, RAID6, RAID10	-	-
Audio Output	2-ch. RCA (2.0 Vp-p, 1 KΩ)	2-ch. RCA (2.0Vp-p, 1 KΩ)	2-ch. RCA (2.0Vp-p, 1 KΩ)	2-ch. RCA (Linear, 1 K Ω)	2-ch. RCA (Linear, 1 K Ω)
Alarm I/O	16/4	16/4	16/4	16/4	16/4
Network Interface	2, RJ45 10M/100M/1000M self-adaptive Ethernet interface	2, RJ-45 10/100/1000 Mbps self-adaptive Ethernet interface	2, RJ-45 10/100/1000 Mbps self-adaptive Ethernet interface	2 RJ-45 10/100/1000 Mbps self-adaptive Ethernet interfaces	2 RJ-45 10/100/1000 Mbps self-adaptive Ethernet interfaces
PoE Port	-	-	-	-	-
USB Port	Front panel: 2 × USB 2.0; Rear panel: 1 × USB 3.0	Front panel: 2 × USB 2.0; Rear panel: 1 × USB 3.0	Front panel: 2 × USB 2.0; Rear panel: 1 × USB 3.0	Front panel: 2 × USB 2.0; Rear panel: 1 × USB 3.0	Front panel: 2 × USB 2.0; Rear panel: 1 × USB 3.0
Smart Function	Supports multiple VCA(Video Content Analytics) events for IP cameras	Supports multiple VCA(Video Content Analytics) events for IP cameras	Supports multiple VCA(Video Content Analytics) events for IP cameras	Supports multiple VCA(Video Content Analytics) events for IP cameras	Supports multiple VCA(Video Content Analytics) events for IP cameras
Power Consumption (without HDD)	≤ 30 W	≤ 30 W	≤ 30 W	≤ 30 W	≤ 30 W
Description	-	-	-	-	-

Pro Series NVR

First choice for small- to medium-sized projects

- › H.264/H.264+, H.265/H.265+, MPEG4 self-adapting decoding
- › Supports VCA search and POS function
- › New easy-to-use GUI 4.0 features intuitive interface
- › Hik-Connect for easy network management



Model	DS-7808NXI-I2/S	DS-7808NXI-I2/8P/S	DS-7816NXI-I2/S	DS-7816NXI-I2/16P/S	DS-7916NXI-I4/S	DS-7916NXI-I4/16P/S
	NEW	NEW	NEW	NEW	NEW	NEW
Image	 AcuSense	 AcuSense	 AcuSense	 AcuSense	 AcuSense	 AcuSense
Hardware Platform	-	-	-	-	-	-
Channel No.	8-ch	8-ch	16-ch	16-ch	16-ch	16-ch
Decoding Format	H.265+/H.265/H.264+/H.264/MPEG4	H.265+/H.265/H.264+/H.264/MPEG4	H.265+/H.265/H.264+/H.264/MPEG4	H.265+/H.265/H.264+/H.264/MPEG4	H.265+/H.265/H.264+/H.264/MPEG4	H.265+/H.265/H.264+/H.264/MPEG4
Incoming/Outgoing Bandwidth	320M/256M	320M/256M	320M/256M	320M/256M	320M/256M	320M/256M
Decoding Capacity	16-ch @ 1080p (30fps)	16-ch @ 1080p (30fps)	16-ch @ 1080p (30fps)	16-ch @ 1080p (30fps)	16-ch @ 1080p (30fps)	16-ch @ 1080p (30fps)
Recording Resolution	32 MP/24 MP/12 MP/8 MP/6 MP/5 MP/4 MP/3 MP/1080p/UXGA/720p/VGA/4CIF/DCIF/2CIF/CIF/QCIF *: 32 MP and 24 MP is only available for channel 1 when ultra HD resolution mode is enabled.	12 MP/8 MP/6 MP/5 MP/4 MP/3 MP/1080p/UXGA/720p/VGA/4CIF/DCIF/2CIF/CIF/QCIF	32 MP/24 MP/12 MP/8 MP/6 MP/5 MP/4 MP/3 MP/1080p/UXGA/720p/VGA/4CIF/DCIF/2CIF/CIF/QCIF *: 32 MP and 24 MP is only available for channel 1 when ultra HD resolution mode is enabled.	12 MP/8 MP/6 MP/5 MP/4 MP/3 MP/1080p/UXGA/720p/VGA/4CIF/DCIF/2CIF/CIF/QCIF	32 MP/24 MP/12 MP/8 MP/6 MP/5 MP/4 MP/3 MP/1080p/UXGA/720p/VGA/4CIF/DCIF/2CIF/CIF/QCIF *: 32 MP and 24 MP is only available for channel 1 when ultra HD resolution mode is enabled.	12 MP/8 MP/6 MP/5 MP/4 MP/3 MP/1080p/UXGA/720p/VGA/4CIF/DCIF/2CIF/CIF/QCIF
Display LCD	1HDMI/1 VGA	1HDMI/1 VGA	1HDMI/1 VGA	1HDMI/1 VGA	2HDMI/1 VGA	2HDMI/1 VGA
Storage Capacity	2 SATA interfaces supporting hot-plug Up to 10TB capacity for each HDD	2 SATA interfaces supporting hot-plug Up to 10TB capacity for each HDD	2 SATA interfaces supporting hot-plug Up to 10TB capacity for each HDD	2 SATA interfaces supporting hot-plug Up to 10TB capacity for each HDD	4 SATA interfaces supporting hot-plug Up to 10TB capacity for each HDD	4 SATA interfaces supporting hot-plug Up to 10TB capacity for each HDD
eSATA / Mini SAS	-	-	-	-	1 eSATA interface	1 eSATA interface
RAID Type	-	-	-	-	-	-
Video Output	HDMI: 4K (3840 × 2160)/60Hz, 4K (3840 × 2160)/30Hz, 1920 × 1080p/60Hz, 1600 × 1200/60Hz, 1280 × 1024/60Hz, 1280 × 720/60Hz, 1024 × 768/60Hz VGA: 1920 × 1080p/60Hz, 1280 × 1024/60Hz, 1280 × 720/60Hz, 1024 × 768/60Hz	HDMI: 4K (3840 × 2160)/60Hz, 4K (3840 × 2160)/30Hz, 1920 × 1080p/60Hz, 1600 × 1200/60Hz, 1280 × 1024/60Hz, 1280 × 720/60Hz, 1024 × 768/60Hz VGA: 1920 × 1080p/60Hz, 1280 × 1024/60Hz, 1280 × 720/60Hz, 1024 × 768/60Hz	HDMI: 4K (3840 × 2160)/60Hz, 4K (3840 × 2160)/30Hz, 1920 × 1080p/60Hz, 1600 × 1200/60Hz, 1280 × 1024/60Hz, 1280 × 720/60Hz, 1024 × 768/60Hz VGA: 1920 × 1080p/60Hz, 1280 × 1024/60Hz, 1280 × 720/60Hz, 1024 × 768/60Hz	HDMI: 4K (3840 × 2160)/60Hz, 4K (3840 × 2160)/30Hz, 1920 × 1080p/60Hz, 1600 × 1200/60Hz, 1280 × 1024/60Hz, 1280 × 720/60Hz, 1024 × 768/60Hz VGA: 1920 × 1080p/60Hz, 1280 × 1024/60Hz, 1280 × 720/60Hz, 1024 × 768/60Hz	HDMI1: 4K (3840 × 2160)/60Hz, 4K (3840 × 2160)/30Hz, 2K (2560 × 1440)/60Hz, 1920 × 1080/60Hz, 1600 × 1200/60Hz, 1280 × 1024/60Hz, 1280 × 720/60Hz, 1024 × 768/60Hz, HDMI1/VGA simultaneous output VGA: 1920 × 1080/60Hz, 1280 × 1024/60Hz, 1280 × 720/60Hz, 1024 × 768/60Hz, HDMI1/VGA simultaneous output HDMI2: 1920 × 1080/60Hz, 1280 × 1024/60Hz, 1280 × 720/60Hz, 1024 × 768/60Hz, HDMI2/VGA independent output	HDMI1: 4K (3840 × 2160)/60Hz, 4K (3840 × 2160)/30Hz, 2K (2560 × 1440)/60Hz, 1920 × 1080/60Hz, 1600 × 1200/60Hz, 1280 × 1024/60Hz, 1280 × 720/60Hz, 1024 × 768/60Hz, HDMI1/VGA simultaneous output VGA: 1920 × 1080/60Hz, 1280 × 1024/60Hz, 1280 × 720/60Hz, 1024 × 768/60Hz, HDMI1/VGA simultaneous output HDMI2: 1920 × 1080/60Hz, 1280 × 1024/60Hz, 1280 × 720/60Hz, 1024 × 768/60Hz, HDMI2/VGA independent output
Audio Output	1-ch, RCA (Linear, 1 KΩ)	1-ch, RCA (Linear, 1 KΩ)	1-ch, RCA (Linear, 1 KΩ)	1-ch, RCA (Linear, 1 KΩ)	1-ch, RCA (Linear, 1 KΩ)	1-ch, RCA (Linear, 1 KΩ)
Alarm I/O	4/1	4/1	4/1	4/1	16/8	16/8
Network Interface	2 RJ-45 10/100/1000 Mbps self adaptive Ethernet interface	1 RJ-45 10/100/1000 Mbps self adaptive Ethernet interface	2 RJ-45 10/100/1000 Mbps self adaptive Ethernet interface	1 RJ-45 10/100/1000 Mbps self adaptive Ethernet interface	2 RJ-45 10/100/1000 Mbps self adaptive Ethernet interface	1 RJ-45 10/100/1000 Mbps self adaptive Ethernet interface
PoE Port	-	8P	-	16P	-	16P
USB Port	Front panel: 1 × USB 2.0; Rear panel: 1 × USB 3.0	Front panel: 1 × USB 2.0; Rear panel: 1 × USB 3.0	Front panel: 1 × USB 2.0; Rear panel: 1 × USB 3.0	Front panel: 1 × USB 2.0; Rear panel: 1 × USB 3.0	Front panel: 2 × USB 2.0; Rear panel: 1 × USB 3.0	Front panel: 2 × USB 2.0; Rear panel: 1 × USB 3.0
Smart Function	Supports multiple VCA(Video Content Analytics) events for IP cameras	Supports multiple VCA(Video Content Analytics) events for IP cameras	Supports multiple VCA(Video Content Analytics) events for IP cameras	Supports multiple VCA(Video Content Analytics) events for IP cameras	Supports multiple VCA(Video Content Analytics) events for IP cameras	Supports multiple VCA(Video Content Analytics) events for IP cameras
Power Consumption (without HDD)	≤15 W	≤15 W	≤15 W	≤15 W	≤30 W	≤30 W
Description	16 libraries with 10,000 face pictures in total Face picture comparison and alarm linkage actions for up to 4 channels Up to 4-ch 2 MP video analysis for human and vehicle recognition to reduce false alarms	16 libraries with 10,000 face pictures in total Face picture comparison and alarm linkage actions for up to 4 channels Up to 4-ch 2 MP video analysis for human and vehicle recognition to reduce false alarms	16 libraries with 10,000 face pictures in total Face picture comparison and alarm linkage actions for up to 4 channels Up to 4-ch 2 MP video analysis for human and vehicle recognition to reduce false alarms	16 libraries with 10,000 face pictures in total Face picture comparison and alarm linkage actions for up to 4 channels Up to 4-ch 2 MP video analysis for human and vehicle recognition to reduce false alarms	16 libraries with 10,000 face pictures in total Face picture comparison and alarm linkage actions for up to 4 channels Up to 4-ch 2 MP video analysis for human and vehicle recognition to reduce false alarms	16 libraries with 10,000 face pictures in total Face picture comparison and alarm linkage actions for up to 4 channels Up to 4-ch 2 MP video analysis for human and vehicle recognition to reduce false alarms

Model	DS-7932NXI-I4/S	DS-7932NXI-I4/16P/S	DS-7808NI-I2	DS-7816NI-I2	DS-7808NI-I2/8P	DS-7816NI-I2/16P
Image	 AcuSense	 AcuSense				
Hardware Platform	-	-	-	-	-	-
Channel No.	32-ch	32-ch	8-ch	16-ch	8-ch	16-ch
Decoding Format	H.265+ /H.265/H.264+ /H.264/MPEG4	H.265+ /H.265/H.264+ /H.264/MPEG4	H.265+ /H.265/H.264+ /H.264/MPEG4	H.265+ /H.265/H.264+ /H.264/MPEG4	H.265+ /H.265/H.264+ /H.264/MPEG4	H.265+ /H.265/H.264+ /H.264/MPEG4
Incoming/Outgoing Bandwidth	320M/256M	320M/256M	320M/256M	320M/256M	320M/256M	320M/256M
Decoding Capacity	16-ch @ 1080p (30fps)	16-ch @ 1080p (30fps)	2-ch @ 12 MP (20fps) / 4-ch @ 8 MP (30fps) / 8-ch @ 4MP (30fps) /16-ch @ 1080p (30fps)	2-ch @ 12 MP (20fps) / 4-ch @ 8 MP (30fps) / 8-ch @ 4MP (30fps) /16-ch @ 1080p (31fps)	2-ch @ 12 MP (20fps) / 4-ch @ 8 MP (30fps) / 8-ch @ 4MP (30fps) /16-ch @ 1080p (33fps)	2-ch @ 12 MP (20fps) / 4-ch @ 8 MP (30fps) / 8-ch @ 4MP (30fps) /16-ch @ 1080p (34fps)
Recording Resolution	32 MP/24 MP/12 MP/8 MP/6 MP/5 MP/4 MP/3 MP/1080p/UXGA/720p/VGA/4CIF/DCIF/2CIF/CIF/QCIF *: 32 MP and 24 MP is only available for channel 1 when ultra HD resolution mode is enabled.	12 MP/8 MP/6 MP/5 MP/4 MP/3 MP/1080p/UXGA/720p/VGA /4CIF/DCIF/2CIF/CIF/QCIF	32 MP/24 MP/12 MP/8 MP/6 MP/5 MP/4 MP/3 MP/1080p/UXGA/720p/VGA /4CIF/DCIF/2CIF/CIF/QCIF *: 32 MP and 24 MP is only available for channel 1 when ultra HD resolution mode is enabled.	32 MP/24 MP/12 MP/8 MP/6 MP/5 MP/4 MP/3 MP/1080p/UXGA/720p/VGA /4CIF/DCIF/2CIF/CIF/QCIF *: 32 MP and 24 MP is only available for channel 1 when ultra HD resolution mode is enabled.	12 MP/8 MP/6 MP/5 MP/4 MP/3 MP/1080p/UXGA/720p/VGA /4CIF/DCIF/2CIF/CIF/QCIF	12 MP/8 MP/6 MP/5 MP/4 MP/3 MP/1080p/UXGA/720p/VGA /4CIF/DCIF/2CIF/CIF/QCIF
Display	2HDMI/1 VGA	2HDMI/1 VGA	1HDMI/1 VGA	1HDMI/1 VGA	1HDMI/1 VGA	1HDMI/1 VGA
LCD	-	-	-	-	-	-
Storage Capacity	"4SATA interfaces supporting hot-plug Up to 10TB capacity for each HDD"	"4 SATA interfaces supporting hot-plug Up to 10TB capacity for each HDD"	2 SATA interfaces Up to 10TB capacity for each HDD	2 SATA interfaces Up to 10TB capacity for each HDD	2 SATA interfaces Up to 10TB capacity for each HDD	2 SATA interfaces Up to 10TB capacity for each HDD
eSATA / Mini SAS	1 eSATA interface	1 eSATA interface	-	-	-	-
RAID Type	-	-	-	-	-	-
Video Output	HDMI1: 4K (3840 × 2160)/60Hz, 4K (3840 × 2160)/30Hz, 2K (2560 × 1440)/60Hz, 1920 × 1080/60Hz, 1600 × 1200/60Hz, 1280 × 1024/60Hz, 1280 × 720/60Hz, 1024 × 768/60Hz, HDMI1/VGA simultaneous output VGA: 1920 × 1080/60Hz, 1280 × 1024/60Hz, 1280 × 720/60Hz, 1024 × 768/60Hz, HDMI1/VGA simultaneous output HDMI2: 1920 × 1080/60Hz, 1280 × 1024/60Hz, 1280 × 720/60Hz, 1024 × 768/60Hz, HDMI2/VGA independent output	HDMI1: 4K (3840 × 2160)/60Hz, 4K (3840 × 2160)/30Hz, 2K (2560 × 1440)/60Hz, 1920 × 1080/60Hz, 1600 × 1200/60Hz, 1280 × 1024/60Hz, 1280 × 720/60Hz, 1024 × 768/60Hz, HDMI1/VGA simultaneous output VGA: 1920 × 1080/60Hz, 1280 × 1024/60Hz, 1280 × 720/60Hz, 1024 × 768/60Hz, HDMI1/VGA simultaneous output HDMI2: 1920 × 1080/60Hz, 1280 × 1024/60Hz, 1280 × 720/60Hz, 1024 × 768/60Hz, HDMI2/VGA independent output	HDMI: 4K (3840 × 2160)/60Hz, 4K (3840 × 2160)/30Hz, 1920 × 1080p/60Hz, 1600 × 1200/60Hz, 1280 × 1024/60Hz, 1280 × 720/60Hz, 1024 × 768/60Hz VGA: 1920 × 1080p/60Hz, 1280 × 1024/60Hz, 1280 × 720/60Hz, 1024 × 768/60Hz	HDMI: 4K (3840 × 2160)/60Hz, 4K (3840 × 2160)/30Hz, 1920 × 1080p/60Hz, 1600 × 1200/60Hz, 1280 × 1024/60Hz, 1280 × 720/60Hz, 1024 × 768/60Hz VGA: 1920 × 1080p/60Hz, 1280 × 1024/60Hz, 1280 × 720/60Hz, 1024 × 768/60Hz	HDMI: 4K (3840 × 2160)/60Hz, 4K (3840 × 2160)/30Hz, 1920 × 1080p/60Hz, 1600 × 1200/60Hz, 1280 × 1024/60Hz, 1280 × 720/60Hz, 1024 × 768/60Hz VGA: 1920 × 1080p/60Hz, 1280 × 1024/60Hz, 1280 × 720/60Hz, 1024 × 768/60Hz	HDMI: 4K (3840 × 2160)/60Hz, 4K (3840 × 2160)/30Hz, 1920 × 1080p/60Hz, 1600 × 1200/60Hz, 1280 × 1024/60Hz, 1280 × 720/60Hz, 1024 × 768/60Hz VGA: 1920 × 1080p/60Hz, 1280 × 1024/60Hz, 1280 × 720/60Hz, 1024 × 768/60Hz
Audio Output	1-ch, RCA (Linear, 1 KΩ)	1-ch, RCA (Linear, 1 KΩ)	1-ch, RCA (Linear, 1 KΩ)	1-ch, RCA (Linear, 1 KΩ)	1-ch, RCA (Linear, 1 KΩ)	1-ch, RCA (Linear, 1 KΩ)
Alarm I/O	16/8	16/8	4/1	4/1	4/1	4/1
Network Interface	2 RJ-45 10/100/1000 Mbps self adaptive Ethernet interface	1 RJ-45 10/100/1000 Mbps self adaptive Ethernet interface	1 RJ-45 10/100/1000 Mbps self adaptive Ethernet interface	1 RJ-45 10/100/1000 Mbps self adaptive Ethernet interface	1 RJ-45 10/100/1000 Mbps self adaptive Ethernet interface	1 RJ-45 10/100/1000 Mbps self adaptive Ethernet interface
PoE Port	-	16P	-	-	8P	16P
USB Port	Front panel: 2 × USB 2.0; Rear panel: 1 × USB 3.0	Front panel: 2 × USB 2.0; Rear panel: 1 × USB 3.0	Front panel: 2 × USB 2.0; Rear panel: 1 × USB 3.0	Front panel: 2 × USB 2.0; Rear panel: 1 × USB 3.0	Front panel: 2 × USB 2.0; Rear panel: 1 × USB 3.0	Front panel: 2 × USB 2.0; Rear panel: 1 × USB 3.0
Smart Function	Supports multiple VCA(Video Content Analytics) events for IP cameras	Supports multiple VCA(Video Content Analytics) events for IP cameras	Supports multiple VCA(Video Content Analytics) events for IP cameras	Supports multiple VCA(Video Content Analytics) events for IP cameras	Supports multiple VCA(Video Content Analytics) events for IP cameras	Supports multiple VCA(Video Content Analytics) events for IP cameras
Power Consumption (without HDD)	≤30 W	≤30 W	≤15 W	≤15 W	≤15 W (without enabling PoE)	≤15 W (without enabling PoE)
Description	16 libraries with 10,000 face pictures in total Face picture comparison and alarm linkage actions for up to 4 channels Up to 4-ch 2 MP video analysis for human and vehicle recognition to reduce false alarms	16 libraries with 10,000 face pictures in total Face picture comparison and alarm linkage actions for up to 4 channels Up to 4-ch 2 MP video analysis for human and vehicle recognition to reduce false alarms	-	-	-	-



Model	DS-7916NI-I4	DS-7932NI-I4	DS-7916NI-I4/16P	DS-7932NI-I4/16P	DS-7932NI-I4/24P
Image					
Hardware Platform	-	-	-	-	-
Channel No.	16-ch	32-ch	16-ch	32-ch	32-ch
Decoding Format	H.265+/H.265/H.264+/H.264/ MPEG4	H.265+/H.265/H.264+/H.264/ MPEG4	H.265+/H.265/H.264+/H.264/ MPEG4	H.265+/H.265/H.264+/H.264/ MPEG4	H.265+/H.265/H.264+/H.264/ MPEG4
Incoming/Outgoing Bandwidth	320M/256M	320M/256M	320M/256M	320M/256M	320M/256M
Decoding Capacity	2-ch @ 12 MP (20fps) / 4-ch @ 8 MP (30fps) / 8-ch @ 4MP (30fps) / 16-ch @ 1080p (36fps)	2-ch @ 12 MP (20fps) / 4-ch @ 8 MP (30fps) / 8-ch @ 4MP (30fps) / 16-ch @ 1080p (37fps)	2-ch @ 12 MP (20fps) / 4-ch @ 8 MP (30fps) / 8-ch @ 4MP (30fps) / 16-ch @ 1080p (38fps)	2-ch @ 12 MP (20fps) / 4-ch @ 8 MP (30fps) / 8-ch @ 4MP (30fps) / 16-ch @ 1080p (39fps)	2-ch @ 12 MP (20fps) / 4-ch @ 8 MP (30fps) / 8-ch @ 4MP (30fps) / 16-ch @ 1080p (40fps)
Recording Resolution	32 MP/24 MP/12 MP/8 MP/6 MP/5 MP/4 MP/3 MP/1080p/UXGA/720p/VGA /4CIF/DCIF/2CIF/CIF/QCIF *: 32 MP and 24 MP is only available for channel 1 when ultra HD resolution mode is enabled.	32 MP/24 MP/12 MP/8 MP/6 MP/5 MP/4 MP/3 MP/1080p/UXGA/720p/VGA /4CIF/DCIF/2CIF/CIF/QCIF *: 32 MP and 24 MP is only available for channel 1 when ultra HD resolution mode is enabled.	12 MP/8 MP/6 MP/5 MP/4 MP/3 MP/1080p/UXGA/720p/VGA /4CIF/DCIF/2CIF/CIF/QCIF	12 MP/8 MP/6 MP/5 MP/4 MP/3 MP/1080p/UXGA/720p/VGA /4CIF/DCIF/2CIF/CIF/QCIF	12 MP/8 MP/6 MP/5 MP/4 MP/3 MP/1080p/UXGA/720p/VGA /4CIF/DCIF/2CIF/CIF/QCIF
Display	2HDMI/1 VGA	2HDMI/1 VGA	2HDMI/1 VGA	2HDMI/1 VGA	2HDMI/1 VGA
LCD	-	-	-	-	-
Storage Capacity	4 SATA interfaces Up to 10TB capacity for each HDD	4 SATA interfaces Up to 10TB capacity for each HDD	4 SATA interfaces Up to 10TB capacity for each HDD	4 SATA interfaces Up to 10TB capacity for each HDD	4 SATA interfaces Up to 10TB capacity for each HDD
eSATA / Mini SAS	1 eSATA interface	1 eSATA interface	1 eSATA interface	1 eSATA interface	1 eSATA interface
RAID Type	-	-	-	-	-
Video Output	HDMI1: 4K (3840 × 2160)/60Hz, 4K (3840 × 2160)/30Hz, 2K (2560 × 1440)/60Hz, 1920 × 1080p/60Hz, 1600 × 1200/60Hz, 1280 × 1024/60Hz, 1280 × 720/60Hz, 1024×768/60Hz VGA: 2K (2560 × 1440)/60Hz, 1920 × 1080p/60Hz, 1600 × 1200/60Hz, 1280 × 1024/60Hz, 1280 × 720/60Hz, 1024×768/60Hz HDMI2: 1920 × 1080p/60Hz, 1280 × 1024/60Hz, 1280 × 720/60Hz, 1024 × 768/60Hz	HDMI1: 4K (3840 × 2160)/60Hz, 4K (3840 × 2160)/30Hz, 2K (2560 × 1440)/60Hz, 1920 × 1080p/60Hz, 1600 × 1200/60Hz, 1280 × 1024/60Hz, 1280 × 720/60Hz, 1024×768/60Hz VGA: 2K (2560 × 1440)/60Hz, 1920 × 1080p/60Hz, 1600 × 1200/60Hz, 1280 × 1024/60Hz, 1280 × 720/60Hz, 1024×768/60Hz HDMI2: 1920 × 1080p/60Hz, 1280 × 1024/60Hz, 1280 × 720/60Hz, 1024 × 768/60Hz	HDMI1: 4K (3840 × 2160)/60Hz, 4K (3840 × 2160)/30Hz, 2K (2560 × 1440)/60Hz, 1920 × 1080p/60Hz, 1600 × 1200/60Hz, 1280 × 1024/60Hz, 1280 × 720/60Hz, 1024×768/60Hz VGA: 2K (2560 × 1440)/60Hz, 1920 × 1080p/60Hz, 1600 × 1200/60Hz, 1280 × 1024/60Hz, 1280 × 720/60Hz, 1024×768/60Hz HDMI2: 1920 × 1080p/60Hz, 1280 × 1024/60Hz, 1280 × 720/60Hz, 1024 × 768/60Hz	HDMI1: 4K (3840 × 2160)/60Hz, 4K (3840 × 2160)/30Hz, 2K (2560 × 1440)/60Hz, 1920 × 1080p/60Hz, 1600 × 1200/60Hz, 1280 × 1024/60Hz, 1280 × 720/60Hz, 1024×768/60Hz VGA: 2K (2560 × 1440)/60Hz, 1920 × 1080p/60Hz, 1600 × 1200/60Hz, 1280 × 1024/60Hz, 1280 × 720/60Hz, 1024×768/60Hz HDMI2: 1920 × 1080p/60Hz, 1280 × 1024/60Hz, 1280 × 720/60Hz, 1024 × 768/60Hz	HDMI1: 4K (3840 × 2160)/60Hz, 4K (3840 × 2160)/30Hz, 2K (2560 × 1440)/60Hz, 1920 × 1080p/60Hz, 1600 × 1200/60Hz, 1280 × 1024/60Hz, 1280 × 720/60Hz, 1024×768/60Hz VGA: 2K (2560 × 1440)/60Hz, 1920 × 1080p/60Hz, 1600 × 1200/60Hz, 1280 × 1024/60Hz, 1280 × 720/60Hz, 1024×768/60Hz HDMI2: 1920 × 1080p/60Hz, 1280 × 1024/60Hz, 1280 × 720/60Hz, 1024 × 768/60Hz
Audio Output	1-ch, RCA (Linear, 1 KΩ)	1-ch, RCA (Linear, 1 KΩ)	1-ch, RCA (Linear, 1 KΩ)	1-ch, RCA (Linear, 1 KΩ)	1-ch, RCA (Linear, 1 KΩ)
Alarm I/O	16/8	16/8	16/8	16/8	16/8
Network Interface	2 RJ-45 10/100/1000 Mbps self adaptive Ethernet interface	2 RJ-45 10/100/1000 Mbps self adaptive Ethernet interface	1 RJ-45 10/100/1000 Mbps self adaptive Ethernet interface	1 RJ-45 10/100/1000 Mbps self adaptive Ethernet interface	1 RJ-45 10/100/1000 Mbps self adaptive Ethernet interface
PoE Port	-	-	16P	16P	24P
USB Port	Front panel: 2 × USB 2.0; Rear panel: 1 × USB 3.0	Front panel: 2 × USB 2.0; Rear panel: 1 × USB 3.0	Front panel: 2 × USB 2.0; Rear panel: 1 × USB 3.0	Front panel: 2 × USB 2.0; Rear panel: 1 × USB 3.0	Front panel: 2 × USB 2.0; Rear panel: 1 × USB 3.0
Smart Function	Supports multiple VCA(Video Content Analytics) events for IP cameras	Supports multiple VCA(Video Content Analytics) events for IP cameras	Supports multiple VCA(Video Content Analytics) events for IP cameras	Supports multiple VCA(Video Content Analytics) events for IP cameras	Supports multiple VCA(Video Content Analytics) events for IP cameras
Power Consumption (without HDD)	≤20 W	≤20 W (without enabling PoE)	≤20 W (without enabling PoE)	≤20 W (without enabling PoE)	≤20 W (without enabling PoE)
Description	-	-	-	-	-





Workstation Series

Seeking VMS Partners for Collaboration

- > Unique module featuring outstanding hardware development
- > Supports Windows 10 or Linux Ubuntu OS for third-party VMS
- > Configurable alarm I/O and PoE interfaces for third-party integration
- > Multiple models with corresponding hardware such as CPU, memory, and storage to satisfy a host of applications



Model	DS-9000AI-S16-D	DS-WSELI-T4(/16P)
Image		
Processor	Quad-Core Intel® Xeon® Processor E3 V5 Series	Intel® Celeron® Processor J3455 (2M Cache, up to 2.3 GHz), 64 bit, 4 Core;
Operating System	Ubuntu Linux is installed by default. Microsoft Windows, including Windows 7E, Windows 10, and Windows Server 2012 R2 can be installed	Ubuntu Linux 16.04
System Disk (OS,VMS)	Industrial-level SSD with 128 GB capacity	mSATA 32GB Optional: mSATA 64 GB
Memory	8 GB DDR4. ECC parity. Extendable up to 64 GB	4 GB
No. of Channels	-	-
Decoding Format	-	-
Incoming/Outgoing Bandwidth	-	-
Decoding Capacity	-	-
Recording Resolution	-	-
Display	2 HDMI / 1 VGA	2 HDMI / 1 VGA
LCD	-	-
Storage Capacity	16 SATA interfaces Up to 10 TB for each HDD	4 SATA interfaces Up to 10 TB for each HDD
eSATA / Mini SAS	1 × eSATA interface 2 × mini SAS interface (optional)	-
RAID Type	RAID 0, RAID 1, RAID 5, RAID 6, RAID 10	-
Video Output	VGA:1-ch, resolution: 1080p (1920x1080)/60Hz, UXGA (1600x1200)/60Hz, SXGA(1280x1024)/60Hz, 720p (1280x 720)/60Hz, XGA (1024x768)/60Hz HDMI:Two independent HDMI outputs, resolution: 4K (4096x2160), 4K(3840x2160)/30Hz, 2K (2560x1440)/60Hz, 1080p (1920x1080)/60Hz, UXGA (1600x1200)/60Hz, SXGA (1280x1024)/60Hz, 720p (1280x720)/60Hz, XGA (1024x768)/60Hz	VGA:1920 × 1080/60Hz, 1280 × 1024/60Hz, 1280 × 720/60Hz, 1024 × 768/60Hz HDMI:4K (3840 × 2160)/30Hz, 2K (2560 × 1440)/60Hz, 1920 × 1080/60Hz, 1600 × 1200/60Hz, 1280 × 1024/60Hz, 1280 × 720/60Hz, 1024 × 768/60Hz
Audio Output	1-ch, RCA (2.0 Vp-p, 1 KΩ)	1-ch, 3.5 mm audio connector
Alarm I/O	16/8	16/4
Network Interface	4 × RJ45 10M/100M/1000M self-adaptive Ethernet interface	2, RJ45 10M/100M/1000M self-adaptive Ethernet interface
PoE Port	-	(16 RJ-45 10/100 Mbps self-adaptive Ethernet interfaces)
USB Port	Rear panel: 2 × USB 3.0	Front Panel: 2 × USB 2.0; Rear Panel: 4 × USB 3.0;
Smart Function	-	-
Power Consumption (without HDD)	≤ 350 W	≤ 30 W
Chassis	-	19-inch rack-mounted 1.5U chassis
Description	-	-

Model	DS-WSELI-T2(8P)	DS-WSPLI-T2	DS-WSPLI-T4	DS-WSPLI-T8
Image				
Processor	Intel® Celeron® Processor J3455 (2M Cache, up to 2.3 GHz), 64 bit, 4 Core;	Intel® Core™ i5-8500 Processor (9M Cache, 3.00 GHz, up to 4.10 GHz Optional: G4900, I3-8100, I7-8700, E-2176G	Intel® Core™ i5-8500 Processor (9M Cache, 3.00 GHz, up to 4.10 GHz Optional: G4900, I3-8100, I7-8700, E-2176G	Intel® Xeon® Processor E3-1225 v5, 3.30 GHz Optional: G4400 3M Cache,3.30GHz; i3-6100 3M Cache,3.70GHz; i5-6500 6M Cache,3.20GHz; i7-6700 8M Cache,3.40GHz
Operating System	Ubuntu Linux 16.04	Ubuntu 18.04.2	Ubuntu 18.04.2	Ubuntu Linux 16.04
System Disk (OS,VMS)	mSATA 32 GB Optional: mSATA 64 GB	mSATA 128 GB Optional: mSATA 64 GB	mSATA 128 GB Optional: mSATA 64 GB	mSATA 64 GB Optional: mSATA 128 GB
Memory	4 GB	8 GB Optional: 16 GB	8 GB Optional: 16 GB	8 GB = 2 * 4 GB
No. of Channels	-	-	-	-
Decoding Format	-	-	-	-
Incoming/Outgoing Bandwidth	-	-	-	-
Decoding Capacity	-	-	-	-
Recording Resolution	-	-	-	-
Display	2 HDMI / 1 VGA	2 HDMI / 1 VGA	2 HDMI / 1 VGA	2 HDMI / 1 VGA
LCD	-	-	-	-
Storage Capacity	2 SATA interfaces Up to 10 TB for each HDD	2 SATA interfaces Up to 8 TB for each HDD	4 SATA interfaces Up to 8 TB for each HDD	8 SATA interfaces Up to 10 TB for each HDD
eSATA / Mini SAS	-	-	-	-
RAID Type	-	-	-	-
Video Output	VGA:1920 × 1080/60Hz, 1280 × 1024/60Hz, 1280 × 720/60Hz, 1024 × 768/60Hz HDMI:4K (3840 × 2160)/30Hz, 2K (2560 × 1440)/60Hz, 1920 × 1080/60Hz, 1600 × 1200/60Hz, 1280 × 1024/60Hz, 1280 × 720/60Hz, 1024 × 768/60Hz	VGA:1920 × 1080/60Hz, 1280 × 1024/60Hz, 1280 × 720/60Hz, 1024 × 768/60Hz HDMI:4K (3840 × 2160)/30Hz, 2K (2560 × 1440)/60Hz, 1920 × 1080/60Hz, 1600 × 1200/60Hz, 1280 × 1024/60Hz, 1280 × 720/60Hz, 1024 × 768/60Hz	VGA:1920 × 1080/60Hz, 1280 × 1024/60Hz, 1280 × 720/60Hz, 1024 × 768/60Hz HDMI:4K (3840 × 2160)/30Hz, 2K (2560 × 1440)/60Hz, 1920 × 1080/60Hz, 1600 × 1200/60Hz, 1280 × 1024/60Hz, 1280 × 720/60Hz, 1024 × 768/60Hz	VGA:1920 × 1080/60Hz, 1280 × 1024/60Hz, 1280 × 720/60Hz, 1024 × 768/60Hz HDMI:4K (3840 × 2160)/30Hz, 2K (2560 × 1440)/60Hz, 1920 × 1080/60Hz, 1600 × 1200/60Hz, 1280 × 1024/60Hz, 1280 × 720/60Hz, 1024 × 768/60Hz
Audio Output	1-ch, 3.5 mm audio connector	1-ch, 3.5 mm audio connector	1-ch, 3.5 mm audio connector	1-ch, 3.5 mm audio connector
Alarm I/O	4/2	4/2	4/2	Optional: 16/4
Network Interface	2, RJ45 10M/100M/1000M self-adaptive Ethernet interface	2, RJ45 10M/100M/1000M self-adaptive Ethernet interface	2, RJ45 10M/100M/1000M self-adaptive Ethernet interface	2, RJ45 10M/100M/1000M self-adaptive Ethernet interface
PoE Port	(8 RJ-45 10/100 Mbps self-adaptive Ethernet interfaces)	-	-	-
USB Port	Front Panel: 2 × USB 2.0; Rear Panel: 4 × USB 3.0;	Front panel: 2 × USB 2.0, rear panel: 4 × USB 3.0	Front panel: 2 × USB 2.0, rear panel: 4 × USB 3.0	Front Panel: 2 × USB 2.0; Rear Panel: 4 × USB 3.0;
Smart Function	-	-	-	-
Power Consumption (without HDD)	≤ 30 W	≤ 150 W	≤ 150 W	≤ 120 W
Chassis	19-inch rack-mounted 1U chassis	19-inch rack-mounted 1U chassis	19-inch rack-mounted 1.5U chassis	19-inch rack-mounted 2U chassis
Description	-	-	-	-

Network Storage

072 Hybrid SAN

076 Cluster Storage











Hikvision Hybrid SAN Products

Cost-Effective, Dedicated, Superior Data Security and Sustainability

- › Dual mode support: Video Direct Streaming and IPSAN
- › Video Direct Streaming mode eliminates need for recording servers, with excellent cost-effective video storage
- › Video stream-based R/W/Search operation, higher efficiency
- › Super N+1 failover (1 failover node to take over traffic of multiple faulty nodes) providing enhanced video safety
- › Proven lab and field compatibility in IPSAN mode with leading VMSs such as Milestone, AXXON, ISS, etc.
- › Supports local, remote, and scheduled backup
- › Hybrid SAN with pre-installed HDDs creates cost-effective solutions for long-term storage
- › Supports ONVIF, PSIA, and RTSP protocols and extended data retention (with third-party cameras such as Bosch, Axis, Sony, Samsung, etc.)



Model		DS-A81016S	DS-A80624S	DS-A82024D	DS-A72024R
Image					
Performance	Direct Streaming mode: video (2 Mbps) + picture	320-ch recording + playback	320-ch recording + playback	448-ch (recording + playback)	820-ch recording + playback
	IPSAN	180-ch recording + playback	180-ch recording + playback	256-ch (recording + playback)	-
Controller	Processor	One controller (64-bit multi-core processor)	One controller (64-bit multi-core processor)	Dual controller (64-bit multi-core processor)	Dual 64-bit multi-core processor
	Cache	4 GB (extendable to 32 GB)	4 GB (extendable to 32 GB)	8 GB (extendable to 32 GB)/controller	8 GB (extendable to 128 GB)
HDD	HDD slot	16	24	24	24
	Interface/capacity	2TB, 4TB, 6TB, 8TB, 10TB, 12TB, 14TB, 16TB	2TB, 4TB, 6TB, 8TB, 10TB, 12TB, 14TB, 16TB	2TB, 4TB, 6TB, 8TB, 10TB, 12TB, 14TB, 16TB	2TB, 4TB, 6TB, 8TB, 10TB, 12TB, 14TB, 16TB
	RAID	RAID0, 1, 3, 5, 6, 10, 50, VRAID, JBOD, Hot-spare	RAID 0, 1, 3, 5, 6, 10, 50, VRAID, JBOD, Hot-Spare	RAID0, 1, 3, 5, 6, 10, 50, JBOD, Hot-Spare	RAID 0, 1, 3, 5, 6, 10, 50, VRAID, JBOD, hot spare
Network	Protocol	iSCSI, RTSP, ONVIF, PSIA	iSCSI, RTSP, ONVIF, PSIA	iSCSI, RTSP, ONVIF, PSIA	iSCSI, RTSP, ONVIF, PSIA
Storage Management	Disk management	Disk inspection, alarm and repair	Disk inspection, alarm and repair	Disk inspection, alarm and repair	Disk inspection, alarm and repair
	Logical volume management	iSCSI volume, video volume management	iSCSI volume, video volume management	iSCSI volume, video volume management	iSCSI volume, video volume management
Recording Management	Recording mode	Timing recording, manual recording, dual-stream recording, alarm recording	Timing recording, manual recording, dual-stream recording, alarm recording	Timing recording, manual recording, dual-stream recording, alarm recording	Timing recording, manual recording, dual-stream recording, alarm recording
	Video protection	Lock key video, N+1 service protection, ANR, video loss detection and alarm	Lock key video, N+1 service protection, ANR, video loss detection and alarm	Lock key video, N+1 service protection, ANR, video loss detection and alarm	Lock key video, N+1 service protection, ANR, video loss detection and alarm
Device Maintenance	Management mode	Web-based GUI, serial port CLI, centralized management of multiple devices	Web-based GUI, serial port CLI, centralized management of multiple devices	Web-based GUI, serial port CLI, centralized management of multiple devices	Web-based GUI, serial port CLI, centralized management of multiple devices
	Alarm mode	Sound, light, email, message, web page	Sound, light, email, message, web page	Sound, light, email, message, web page	Sound, light, email, message, web page
External Interface	Data network interface	3, 1000M Ethernet interface	3, 1000M Ethernet interface	4, 1000M Ethernet interface (4 × 6GbE or 2 × 10GbE is extendable) per controller	4, 1000M Ethernet interface (4 × 1GbE or 2 × 10GbE is extendable)
	Management network interface	1, 1000M Ethernet interface	1, 1000M Ethernet interface	1, 1000M Ethernet interface/Controller	1, 1000M Ethernet interface/Controller
	Mini SAS interface	Supported	Supported	Supported	Supported
General	Power supply	Redundant	Redundant	Redundant	Redundant
	Dimensions(W × H × D)	3U Chassis(486 x 134 x 535 mm)	4U Chassis(484 x 174 x 568 mm)	4U Chassis(484 x 174 x 760 mm)	4U Chassis(484 x 174 x 724 mm)

Model		DS-AT1000S/234	DS-AT1000S/288	DS-AT1000S/342	DS-AT1000S/432
Image		 NEW	 NEW	 NEW	 NEW
Performance	Direct Streaming mode: video (2 Mbps) + picture	256-ch recording + playback	256-ch recording + playback	400-ch recording + playback	400-ch recording + playback
	IPSAN	-	-	-	-
Controller	Processor	64-bit multi-core processor	64-bit multi-core processor	64-bit multi-core processor	64-bit multi-core processor
	Cache	12 GB (extendable to 32 GB)	12 GB (extendable to 32 GB)	16 GB (extendable to 32 GB)	16 GB (extendable to 32 GB)
HDD	HDD slot	16 (the device is packaged with 13 HDDs)	16 (the device is packaged with 16 HDDs)	24 (the device is packaged with 19 HDDs)	24 (the device is packaged with 24 HDDs)
	Interface/capacity	SATA / 18 TB	SATA / 18 TB	SATA / 18 TB	SATA / 18 TB
	RAID	iRAID, RAID5, RAID6	iRAID, RAID5, RAID6	iRAID, RAID5, RAID6	iRAID, RAID5, RAID6
Network	Protocol	RTSP, ONVIF, HKSDK	RTSP, ONVIF, HKSDK	RTSP, ONVIF, HKSDK	RTSP, ONVIF, HKSDK
Storage Management	Disk management	Disk detection pre-alarm and repair	Disk detection pre-alarm and repair	Disk detection pre-alarm and repair	Disk detection pre-alarm and repair
	Logical volume management	Recording volume management	Recording volume management	Recording volume management	Recording volume management
Recording Management	Recording mode	Continuous recording, manual recording, and alarm recording	Continuous recording, manual recording, and alarm recording	Continuous recording, manual recording, and alarm recording	Continuous recording, manual recording, and alarm recording
	Video protection	Video lock, video loss alarm	Video lock, video loss alarm	Video lock, video loss alarm	Video lock, video loss alarm
Device Maintenance	Management mode	GUI based on web, serial port CLI, platform	GUI based on web, serial port CLI, platform	GUI based on web, serial port CLI, platform	GUI based on web, serial port CLI, platform
	Alarm mode	Audio, indicator, GUI	Audio, indicator, GUI	Audio, indicator, GUI	Audio, indicator, GUI
External Interface	Data network interface	3, 1000 Mbps Ethernet interface	3, 1000 Mbps Ethernet interface	4, 1000 Mbps Ethernet interface	4, 1000 Mbps Ethernet interface
	Management network interface	1, 1000 Mbps Ethernet interface	1, 1000 Mbps Ethernet interface	1, 1000 Mbps Ethernet interface	1, 1000 Mbps Ethernet interface
	Mini SAS interface	N/A	N/A	N/A	N/A
General	Power supply	Redundant	Redundant	Redundant	Redundant
	Dimensions(W × H × D)	3U Chassis(486 × 134 × 535 mm)	3U Chassis(486 × 134 × 535 mm)	4U Chassis(484 × 174 × 724 mm)	4U Chassis(484 × 174 × 724 mm)

Model		DS-AJ7824D
Image		
Controller Parameters	Controller	2 Controller
	SAS Interface (Upper-level)	2 (12 Gbps)
	SAS Interface (Lower-level)	1 (12 Gbps)
	HDD Interfaces	24
	HDD Interface Type	SAS
	Hot Swap HDD	Supported
	Power	Redundant (1+1)
	Applicable Models	DS-A82024D
	Chassis	4U Chassis
General	Dimensions(W × H × D)	484 x 174 x 760 mm
	Weight (without hard disk)	40 kg (88.2 lb)
	Consumption (with max. hard disks)	≤ 550 W

Model		DS-AD82012D-ODL	
Image		 NEW	
Every Controller	Processor	multi-core processor	
	Cache	8 GB	
	Network Interface	4 × 10 Gbps per controller	
	Array Channel	2 × 12Gb SAS	
	Max. Storage Space	3.1 PB	
	Max. Disk Number	264	
Cabinet	Enclosure	Multilevel	
	Network Exchange	8 × 10 Gbps RJ45 interface, or 8 × 10 Gbps fiber optic interface, or 8 × 16GbFC interface, or 8 × 12GbSAS interface, or the mixture of 4 × 10 Gbps fiber optic interface and 4 × 16GbFC interface	
	Power Supply	Redundant power supply (1+1)	
	HDD Interfaces	12 (The default full match)	
	HDD Interface Type	SAS	
	Application	support IPSAN,FCSAN (snapshot,replication,clone,Thin provisioning)	
	Software	Management Method	GUI based on web, in-band and out-band, support the unified management of multiple devices
		Management Software	Web browser and client software
General	Dimension (W × D × H)	483 × 88 × 603 mm (19.0 × 3.5 × 23.7 inch), standard 2U chassis	
	Weight (Maximum Capacity)	32 kg (70.5 lb)	
	Consumption (without HDD)	≤ 580 W	
	Temperature	Working temperature: 10 °C to 35 °C (50 °F to 95 °F) Storing temperature: -20 °C to 65 °C (-4 °F to 149 °F)	
	Humidity	Working humidity: 20% to 80% RH (non-freezing, non-condensing) Storing humidity: 5% to 90% RH (non-freezing, non-condensing)	

Model		DS-AJ6884D-ODL
Image		 NEW
Controller Parameters	Controller	2 Controller
	HDD Interfaces	84 (The default full match)
	HDD Interface Type	SAS
	Enclosure	Multilevel
	Power	Redundant (1+1)
	Applicable Models	DS-AD82012D-ODL
	Chassis	standard 5U chassis
	Dimension (W × D × H)	483 × 222 × 975 mm (19.0 × 8.7 × 38.4 inch)
	Weight (Maximum Capacity)	135 kg (297.6 lb)
General	Consumption (without HDD)	≤ 2200 W





Hikvision Cluster Storage Products

High Performance, High Scalability, High Reliability,
High Availability

- > Clustering technology creates load balancing and prevents single-point failure
- > Supports fault tolerance to prevent single device failure
- > Virtual management unifies storage resources to one pool for flexible utilization.
- > Storage types include video, images, files, and objects
- > Equipment-level redundancy reaches the highest levels of data security
- > Real-time online system capacity expansion; one cluster device can expand to up to 30,000 channels of video input and 300 PB storage
- > These products make use of ultra-fault-tolerant Network RAID technology (based on Erasure Code)
- > One IP for the entire storage system means easy maintenance
- > Video can be backed up locally and via cluster storage to improve system reliability



Cluster Storage

Model		DS-A81024S-ICVS	DS-A81048S-ICVS	DS-A83024S-ICVS	DS-A83048S-ICVS
Image		 HOT	 HOT	 HOT	 HOT
Performance	Standard cluster (2 Mbps)	240-ch	240-ch	600-ch	600-ch
	Standard cluster (4 Mbps)	150-ch	150-ch	300-ch	300-ch
Controller	Micro cluster (2 Mbps)	200-ch	200-ch	550-ch	550-ch
	Micro cluster (4 Mbps)	120-ch	120-ch	250-ch	250-ch
HDD	Processor	64-bit multi-core processors	64-bit multi-core processors	2,64-bit multi-core processors	2,64-bit multi-core processors
	Cache	16 GB	32 GB	64 GB (extendable to 384 GB)	64 GB(extendable to 384 GB)
	HDD slot	24	48	24	48
	Interface	SATA / SAS	SATA / SAS	SATA / SAS	SATA / SAS
	Capacity	2TB, 4TB, 6TB, 8TB, 10TB, 12TB, 14TB, 16TB (enterprise HDD)	2TB, 4TB, 6TB, 8TB, 10TB, 12TB, 14TB, 16TB (enterprise HDD)	2TB, 4TB, 6TB, 8TB, 10TB, 12TB, 14TB, 16TB (enterprise HDD)	2TB, 4TB, 6TB, 8TB, 10TB, 12TB, 14TB, 16TB (enterprise HDD)
	Hot-swapping	Supported	Supported	Supported	Supported
	RAID	RAID: N + M: K, N + M ≤ 16, M ≥ K, N ∈ [1, 15], M ∈ [1, 4], K ∈ [1, 4]	RAID: N + M: K, N + M ≤ 16, M ≥ K, N ∈ [1, 15], M ∈ [1, 4], K ∈ [1, 4]	RAID: N + M: K, N + M ≤ 16, M ≥ K, N ∈ [1, 15], M ∈ [1, 4], K ∈ [1, 4]	RAID: N + M: K, N + M ≤ 16, M ≥ K, N ∈ [1, 15], M ∈ [1, 4], K ∈ [1, 4]
	Disk	Disk detection pre-alarm and repair	Disk detection pre-alarm and repair	Disk detection pre-alarm and repair	Disk detection pre-alarm and repair
Storage	Cache protection	Supports customizing BBU in case of unexpected power failure to protect the cache data from being lost.	Supports customizing BBU in case of unexpected power failure to protect the cache data from being lost.	Supports customizing BBU in case of unexpected power failure to protect the cache data from being lost.	Supports customizing BBU in case of unexpected power failure to protect the cache data from being lost.
	CVA	Device access, recording schedule, and stream forwarding services	Device access, recording schedule, and stream forwarding services	Device access, recording schedule, and stream forwarding services	Device access, recording schedule, and stream forwarding services
Recording	CVS	Data storage, video/picture access, storage space, and data R/W services	Data storage, video/picture access, storage space, and data R/W services	Data storage, video/picture access, storage space, and data R/W services	Data storage, video/picture access, storage space, and data R/W services
	Management method	GUI based on web, serial port CLI, platform	GUI based on web, serial port CLI, platform	GUI based on web, serial port CLI, platform	GUI based on web, serial port CLI, platform
Maintenance and Management	Alarm method	Audio, indicator, GUI	Audio, indicator, GUI	Audio, indicator, GUI	Audio, indicator, GUI
	Protocol	RTSP, ONVIF, PSIA, etc.	RTSP, ONVIF, PSIA, etc.	RTSP, ONVIF, PSIA, etc.	RTSP, ONVIF, PSIA, etc.
Network	Data network interface	4, 1000M Ethernet interface (8 × GbE or 4 × 10GbE is extendable)	4, 1000M Ethernet interface (8 × GbE or 4 × 10GbE is extendable)	6, 1000M Ethernet interface (8 × GbE or 4 × 10GbE is extendable)	6, 1000M Ethernet interface (8 × GbE or 4 × 10GbE is extendable)
	Management network interface	1, 1000M Ethernet interface	1, 1000M Ethernet interface	1, 1000M Ethernet interface	1, 1000M Ethernet interface
	SAS extension interface	3, 12 Gbps SAS 3.0 interface	3, 12 Gbps SAS 3.0 interface	3, 12 Gbps SAS 3.0 interface	3, 12 Gbps SAS 3.0 interface
	COM interface	2 (1 for RS-232, 1 for RS-485)	2 (1 for RS-232, 1 for RS-485)	2 (1 for RS-232, 1 for RS-485)	2 (1 for RS-232, 1 for RS-485)
	USB interface	3 (2 × USB 3.0, 1 × USB 2.0)	3 (2 × USB 3.0, 1 × USB 2.0)	3 (2 × USB 3.0, 1 × USB 2.0)	3 (2 × USB 3.0, 1 × USB 2.0)
	VGA interface	1	1	-	-
	Power supply (rated)	Redundant 1 + 1, ≤ 550 W	Redundant 2 + 1, ≤ 1600 W	Redundant 1 + 1, ≤ 550 W	Redundant 2 + 1, ≤ 1600 W
General	Consumption (withHDDs)	≤ 420 W	≤ 710 W	≤ 484 W	≤ 763 W
	Environment temperature	Working: +5 °C to +35 °C (+41 °F to +95 °F) Storage: -20 °C to +70 °C (-4 °F to +158 °F)	Working: +5 °C to +35 °C (+41 °F to +95 °F) Storage: -20 °C to +70 °C (-4 °F to +158 °F)	Working: +5 °C to +35 °C (+41 °F to +95 °F) Storage: -20 °C to +70 °C (-4 °F to +158 °F)	Working: +5 °C to +35 °C (+41 °F to +95 °F) Storage: -20 °C to +70 °C (-4 °F to +158 °F)
	Environment humidity	Working: 20% to 80%RH (non-condensing/frozen) Storage: 5% to 90%RH (non-condensing/frozen)	Working: 20% to 80%RH (non-condensing/frozen) Storage: 5% to 90%RH (non-condensing/frozen)	Working: 20% to 80%RH (non-condensing/frozen) Storage: 5% to 90%RH (non-condensing/frozen)	Working: 20% to 80%RH (non-condensing/frozen) Storage: 5% to 90%RH (non-condensing/frozen)
	Dimension (W × H × D)	484 x 174 x 760 mm	487 x 345 x 751 mm	484 x 174 x 760 mm	487 x 345 x 751 mm
	Weight (without HDDs)	≤ 43 kg (90.4 lb)	≤ 70 kg (154.3 lb)	≤ 43 kg (94.8 lb)	≤ 93 kg (205 lb)

Data Center

079 DeepinMind Server

083 General Purpose Server









DeepinMind Server



Create Utility, Accurate, and Innovative AI



- Fast and accurate facial, human body, vehicle and behavior recognition based on Deep Learning algorithms
- Professional GPU accelerator with high computing capacity
- Supports clustered implementation to facilitate load balancing, dynamic expansion, and system failover
- Abundance of functions to meet needs in a multitude of scenarios and requirements





Model	DS-IF1032-03U/X	DS-IF1064-03U/X	DS-IF2003-A3H/NF	DS-IF2006-A3H/NF	
Image					
					
Facial analysis	Function module	Facial tracking, facial detection, facial rating, facial modeling, facial attribute analysis, facial comparison and alarm	Facial tracking, facial detection, facial rating, facial modeling, facial attribute analysis, facial comparison and alarm	Facial tracking, facial detection, facial rating, facial modeling, facial attribute analysis, facial comparison and alarm	Facial tracking, facial detection, facial rating, facial modeling, facial attribute analysis, facial comparison and alarm
	Facial attribute	Age, gender, smile, glasses, mask	Age, gender, smile, glasses, mask	Age, gender, smile, glasses, mask	Age, gender, smile, glasses, mask
	Video streaming performance	32-channel (1080p to 800W)	64-channel (1080P)	60-channel (1080P)	120-channel (1080P)
	Image streaming performance	160 pics/s	320 pics/s	450 pics/s	900 pics/s
	Format	jpeg, gif, bmp, png, tif	jpeg, gif, bmp, png, tif	jpeg, gif, bmp, png, tif	jpeg, gif, bmp, png, tif
Video structuralization	List storage capacity	1 million	1 million	3 million	3 million
	Function module	Moving target detection, tracking, rating, attribute analysis, modeling	Moving target detection, tracking, rating, attribute analysis, modeling	Moving target detection, tracking, rating, attribute analysis, modeling	Moving target detection, tracking, rating, attribute analysis, modeling
	Video processing performance	32-channel (1080p to 800W)	64-channel (1080P)	60-channel (1080P)	120-channel (1080P)
	Security image processing performance	48 pics/s	64 pics/s (500W)	85 pics/s (500W)	170 pics/s (500W)
	Human body attribute	Target direction/size/speed, upper/lower body clothing/color, age, hair, style, gender, whether riding, whether carrying bag, whether wearing hat, mask, whether carrying article, number of personnel on non-motor vehicle, vehicle type	Target direction/size/speed, upper/lower body clothing/color, age, hair, style, gender, whether riding, whether carrying bag, whether wearing hat, mask, whether carrying article, number of personnel on non-motor vehicle, vehicle type	Target direction/size/speed, upper/lower body clothing/color, age, hair, style, gender, whether riding, whether carrying bag, whether wearing hat, mask, whether carrying article, number of personnel on non-motor vehicle, vehicle type	Target direction/size/speed, upper/lower body clothing/color, age, hair, style, gender, whether riding, whether carrying bag, whether wearing hat, mask, whether carrying article, number of personnel on non-motor vehicle, vehicle type
	Vehicle attribute	license plate number, vehicle color, vehicle type, vehicle main brand	license plate number, vehicle color, vehicle type, vehicle main brand	license plate number, vehicle color, vehicle type, vehicle main brand	license plate number, vehicle color, vehicle type, vehicle main brand
	Function module	Vehicle detection, vehicle modeling, vehicle attribute analysis, vehicle recognition	Vehicle detection, vehicle modeling, vehicle attribute analysis, vehicle recognition	Vehicle detection, vehicle modeling, vehicle attribute analysis, vehicle recognition	Vehicle detection, vehicle modeling, vehicle attribute analysis, vehicle recognition
Vehicle analysis	Resolution	256 x 256 to 900 W pixel	256 x 256 to 900W Pixel	256 x 256 to 900W Pixel	256 x 256 to 900W Pixel
	Analysis and modeling	6 million pieces/day (7 MP)	8 million pieces/day (7 MP)	5.1 million pieces/day (7 MP)	10.2 million pieces/day (7 MP)
	Format	Standard JPG/JPEG, BMP, PNG/TIFF, TIF, static GIF	Standard JPG/JPEG, BMP, PNG/TIFF, TIF, static GIF	Standard JPG/JPEG, BMP, PNG/TIFF, TIF, static GIF	Standard JPG/JPEG, BMP, PNG/TIFF, TIF, static GIF
*The above performance of facial analysis, vehicle analysis and video structuralization is mutually exclusive.					
General	4 × USB 3.0 interface, 2 × USB 2.0 interface	4 × USB 3.0 interface, 2 × USB 2.0 interface	2 × USB 3.0 interface, 2 × USB 2.0 interface	2 × USB 3.0 interface, 2 × USB 2.0 interface	
	1 × VGA interface	1 × VGA interface	1 × VGA interface	1 × VGA interface	
	4 × 1000M Ethernet interface	4 × 1000M Ethernet interface	4 × 1000M self-adaptive Ethernet interface	4 × 1000M self-adaptive Ethernet interface	
	19-inch 1.5U chassis	19-inch 1U chassis	19-inch 2U chassis	19-inch 2U chassis	
	Power consumption: 360 W	Power consumption: 240 W	Power consumption: 750 W	Power consumption: 1600 W	
	Working temperature: +5°C to +35°C (41°F to 95 °F)	Working temperature: +5°C to +35°C (41°F to 95 °F)	Working temperature: +5°C to +35°C (41°F to 95 °F)	Working temperature: +5°C to +35°C (41°F to 95 °F)	
	Storage temperature: -40 °C to +70 °C (-40 °F to +158 °F)	Storage temperature: -40 °C to +70 °C (-40 °F to +158 °F)	Storage temperature: -40 °C to +70 °C (-40 °F to +158 °F)	Storage temperature: -40 °C to +70 °C (-40 °F to +158 °F)	
Working humidity: 10% to 90%	Working humidity: 10% to 90%	Working humidity: 8% to 90% (without condensation)	Working humidity: 8% to 90% (without condensation)		

Model	DS-VBD1HH-UH/H	
Image		
		
Data type (mixed storage for multiple data types)	Human face data Human body data Vehicle data	
Storage capacity (storage capacity for single data type)	2.4 billion pieces of human face data 3 billion pieces of human body data 6 billion pieces of vehicle data	
Search by picture (storage capacity for single data type)	Accelerated searching for 100 million pieces of structured data	
Application function	Human face	Attribute search, search by picture, area comparison, frequently appeared person analysis, destination analysis, companion analysis, statistics analysis, human arming, etc.
	Human body	Attribute search, statistics analysis, search by picture, etc.
	Vehicle	Vehicle search, trace search, facial masking in night, entering downtown for first time, frequent entrance & exit, area comparison, search by picture, vehicle with fake license plate analysis, model arming, etc.
Mainboard	CPU	Intel® Xeon® 6230 CPU x 2
	Memory	512 GB DDR4
Interface	Hard disk drive	240 GB M.2 × 1 (system) + 240 GB M.2 × 1 + 6 TB PCIe SSD × 1 + 4 TB 7.2 K SATA × 6 (RAID_10)
	Data interface	10 GbE x 2 + 1GbE x 2
Power	Power module	750 W (1 + 1)

Model		DS-VBD1HH-UF/H
Image		 
Data type (mixed storage for multiple data types)		Human face data Human body data Vehicle data
Storage capacity (storage capacity for single data type)		800 million pieces of human face data 1 billion pieces of human body data 2 billion pieces of vehicle data
Search by picture (storage capacity for single data type)		Accelerated searching for 30 million pieces of structured data
Application function	Human face	Attribute search, search by picture, area comparison, frequently appeared person analysis, destination analysis, companion analysis, statistics analysis, human arming, etc.
	Human body	Attribute search, statistics analysis, search by picture, etc.
	Vehicle	Vehicle search, trace search, facial masking in night, entering downtown for first time, frequent entrance & exit, area comparison, search by picture, vehicle with fake license plate analysis, model arming, etc.
Mainboard	CPU	Intel © Xeon© 4114 CPU x 2
	Memory	256 GB DDR4
	Hard disk drive	240 GB M.2 x 2 + 480 GB SSD x 6 + 4 TB 7.2 K SATA x 2 (RAID_1)
Interface	Data interface	GigE x 4 or above
Power	Power module	750 W (1 + 1)

Model		DS-IX2001-A3U/X	DS-IX2002-A3U/X	DS-IX2003-A3U/X	
Image					
Device performance	Face picture analysis	Analysis type	Supports analysis, comparison and classification of faces in pictures, real-time videos or recordings.	Supports analysis, comparison and classification of faces in pictures, real-time videos or recordings.	Supports analysis, comparison and classification of faces in pictures, real-time videos or recordings.
		Picture analysis and comparison	120 pieces/second;Format: jpeg, bmp, tif, png	240 pieces/second;Format: jpeg, bmp, tif, png	360 pieces/second;Format: jpeg, bmp, tif, png
		Video analysis and comparison	20 channels (1080 P)	40 channels (1080 P)	60 channels (1080 P)
		List Library	3 million pictures in total (≤ 128 list libraries)	3 million pictures in total (≤ 128 list libraries)	3 million pictures in total (≤ 128 list libraries)
		1 V 1 comparison	22 pairs/second	22 pairs/second	22 pairs/second
	Video structured data analysis	Imported video analysis	Single video size ≤ 10 GB, and total video size ≤ 100 GB Max. 40 times accelerated analysis speed Format: ts, svac, mbf, ps, mp4, avi, asf	Single video size ≤ 10 GB, and total video size ≤ 100 GB Max. 40 times accelerated analysis speed Format: ts, svac, mbf, ps, mp4, avi, asf	Single video size ≤ 10 GB, and total video size ≤ 100 GB Max. 40 times accelerated analysis speed Format: ts, svac, mbf, ps, mp4, avi, asf
		Analysis Type	Supports analysis and modelling for human bodies or vehicles in pictures, real-time videos or recordings.	Supports analysis and modelling for human bodies or vehicles in pictures, real-time videos or recordings.	Supports analysis and modelling for human bodies or vehicles in pictures, real-time videos or recordings.
		Analysis of human body or vehicle pictures	30 pieces/second Format: jpeg, bmp, tif, png	60 pieces/second Format: jpeg, bmp, tif, png	90 pieces/second Format: jpeg, bmp, tif, png
		Analysis of human body or vehicle videos	20 channels (1080 P)	40 channels (1080 P)	60 channels (1080 P)
		Imported video analysis	Single video size ≤ 10 GB, and total video size ≤ 100 GB; Max. 40 times accelerated analysis speed; Format: ts, svac, mbf, ps, mp4, avi, asf	Single video size ≤ 10 GB, and total video size ≤ 100 GB; Max. 40 times accelerated analysis speed; Format: ts, svac, mbf, ps, mp4, avi, asf	Single video size ≤ 10 GB, and total video size ≤ 100 GB; Max. 40 times accelerated analysis speed; Format: ts, svac, mbf, ps, mp4, avi, asf
*The above performance of facial analysis, vehicle analysis and video structuralization is mutually exclusive.					
Data storage	Picture and structured data	30 million	50 million	50 million	
	List library	10 million (including 3 million alarm library)	10 million (including 3 million alarm library)	10 million (including 3 million alarm library)	
	Interface	Network interface	Gigabit Ethernet self-adaptive interface × 4	Gigabit Ethernet self-adaptive interface × 4	Gigabit Ethernet self-adaptive interface × 4
USB interface		USB 2.0 × 2 + USB 3.0 × 2	USB 2.0 × 2 + USB 3.0 × 2	USB 2.0 × 2 + USB 3.0 × 2	
VGA interface		2	2	2	
Hardware	General	Chassis specification	19 inch 2 U standard chassis	19 inch 2 U standard chassis	19 inch 2 U standard chassis
		Power module	Hot-plugged efficient 1+1 redundant power module	Hot-plugged efficient 1+1 redundant power module	Hot-plugged efficient 1+1 redundant power module
		Power consumption	750 W	1600 W	1600 W
	Storage temperature	-40°C to 70°C (-40°F to 158 °F)	-40°C to 70°C (-40°F to 158 °F)	-40°C to 70°C (-40°F to 158 °F)	
	Working temperature	5°C to 35°C (41°F to 95 °F)	5°C to 35°C (41°F to 95 °F)	5°C to 35°C (41°F to 95 °F)	
	Working humidity	8% to 90% (without condensation)	8% to 90% (without condensation)	8% to 90% (without condensation)	
	Dimension (L × W × H)	715.5 mm × 482 mm × 86.8 mm (28.2 inch × 19.0 inch × 3.4 inch)	715.5 mm × 482 mm × 86.8 mm (28.2 inch × 19.0 inch × 3.4 inch)	715.5 mm × 482 mm × 86.8 mm (28.2 inch × 19.0 inch × 3.4 inch)	
Package size (L × W × H)	965 mm × 670 mm × 320 mm (38.0 inch × 29.4 inch × 12.6 inch)	965 mm × 670 mm × 320 mm (38.0 inch × 29.4 inch × 12.6 inch)	965 mm × 670 mm × 320 mm (38.0 inch × 29.4 inch × 12.6 inch)		

Model		DS-IE1016-03U/BA	DS-IE1032-03U/BA	DS-IE1064-03U/BA
Image		 DeepinMind	 DeepinMind	 DeepinMind
Function	Perimeter protection detection	Line crossing, region entrance/exiting, area intrusion, loitering, unattended baggage	Line crossing, region entrance/exiting, area intrusion, loitering, unattended baggage	"Line crossing, region entrance/exiting, area intrusion, loitering, unattended baggage"
	Street abnormal behavior detection	Physical conflict, people gathering, and falling down	Physical conflict, people gathering, and falling down	Physical conflict, people gathering, and falling down
	Situation analysis	People density, real-time people counting, and people counting	People density, real-time people counting, and people counting	People density, real-time people counting, and people counting
	Indoor behavior detection	Absence, abnormal number of people, playing mobile phone	Absence, abnormal number of people, playing mobile phone	Absence, abnormal number of people, playing mobile phone
Access Performance	Access channel	16-channel standard H.264, H.265 code stream real-time analysis	32-channel standard H.264, H.265 code stream real-time analysis	64-channel standard H.264, H.265 code stream real-time analysis
	Resolution	720p-800W (recommended 1080p)	720p-800W (recommended 1080p)	720p-800W (recommended 1080p)
	Processor	1 Intel E3 series CPU	1 Intel E3 series CPU	1 Intel E3 series CPU
	Memory	8 G DDR3	8G DDR3	8G DDR3
	Hard disk	1 built-in 240 G SSD	1 built-in 240 G SSD	1 built-in 240 G SSD
Interface	Network	4 Gigabit adaptive network ports	4 Gigabit adaptive network ports	4 Gigabit adaptive network ports
	USB 3.0	4	4	4
	USB 2.0	2	2	2
	VGA	1	1	1
	Hard Disk Interface	1 SATA interface, 1 mini-SATA interface	1 SATA interface, 1 mini-SATA interface	1 SATA interface, 1 mini-SATA interface
Others	Chassis	19-inch 1U standard chassis	19-inch 1U standard chassis	19-inch 1U standard chassis
	Power supply	Hot-swappable high-efficiency 1+1 redundant power supply	Hot-swappable high-efficiency 1+1 redundant power supply	Hot-swappable high-efficiency 1+1 redundant power supply
	Consumption (rated)	800 W	800 W	800 W
	Consumption	400 W	400 W	400 W
	Working temperature	5°C to +35°C	5°C to +35°C	5°C to +35°C
	Storage temperature	-40°C to +70°C	-40°C to +70°C	-40°C to +70°C
	Working humidity	10% to 90%, no condensation	10% to 90%, no condensation	10% to 90%, no condensation
	Dimensions (W × D × H)	439 × 591 × 44 mm	439 × 591 × 44 mm	439 × 591 × 44 mm



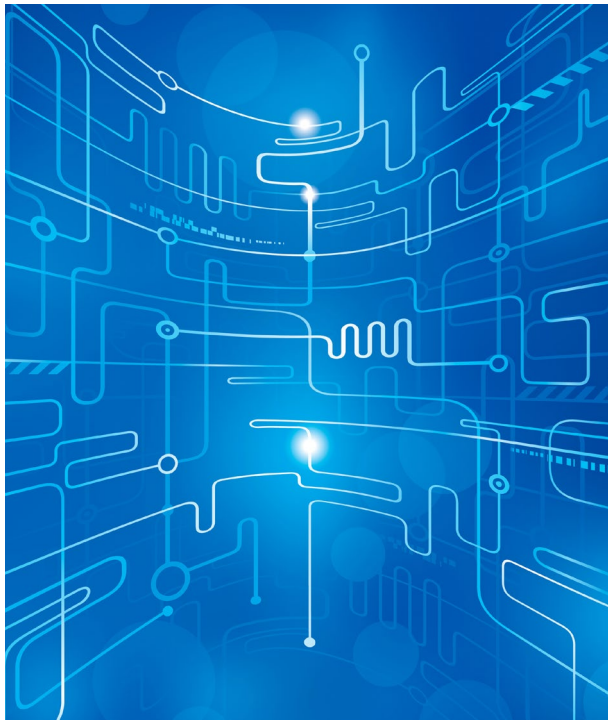

General Purpose Server

Nearly Endless Applications

With high-performance hardware, General Purpose Servers have been expertly designed for various types of applications, such as in financial institutions, stock markets, transportation centers, postal and telecommunications centers, energy production, and other remote environments. These capable servers meet and exceed the strict requirements on performance, data scalability, and reliability.



Model	DS-VD22D-BHW2	DS-VD22D-BHW5	DS-VD22D-BHW6
Image			
Processor	one Intel® Xeon® SP(4110*1)	two Intel® Xeon® SP(4114*2)	two Intel® Xeon® SP(4110*2)
Memory	32G DDR4 DIMM	64G DDR4 DIMM	32G DDR4 DIMM
storage controllers	PERC H330	PERC H330	PERC H330
Drive Bays	1TB 7.2K SATA*2(RAID_1)	600G SAS 15K*4(RAID_10)	1TB 7.2K SATA*2(RAID_1)
Power supplies	495W(1+1)	495W(1+1)	495W(1+1)
Sizing	Form factor: Rack (2U) Chassis depth: 715.5 mm 715.5 × 482 × 86.8 mm (28.2 × 19.0 × 3.4 inch)	Form factor: Rack (2U) Chassis depth: 715.5 mm 715.5 × 482 × 86.8 mm (28.2 × 19.0 × 3.4 inch)	Form factor: Rack (2U) Chassis depth: 715.5 mm 715.5 × 482 × 86.8 mm (28.2 × 19.0 × 3.4 inch)
Sizing with Package	960 × 610 × 295 mm (37.8 × 24.0 × 11.6 inch)	960 × 610 × 295 mm (37.8 × 24.0 × 11.6 inch)	960 × 610 × 295 mm (37.8 × 24.0 × 11.6 inch)
Embedded management	iDRAC9, Enterprise	iDRAC9, Enterprise	iDRAC9, Enterprise
Bezel	security bezel	security bezel	security bezel
OpenManage™ Software	OpenManage Enterprise Mobile OpenManage Essentials OpenManage Power Center	OpenManage Enterprise Mobile OpenManage Essentials OpenManage Power Center	OpenManage Enterprise Mobile OpenManage Essentials OpenManage Power Center
Integrations and connections	Integrations: Microsoft® System Center, VMware® vCenter™, BMC Software Connections: Nagios & Nagios XI, Oracle Enterprise Manager, HP Operations Manager, IBM Tivoli Netcool/OMNibus, IBM Tivoli® Network Manager, CA Network and Systems Management	Integrations: Microsoft® System Center, VMware® vCenter™, BMC Software Connections: Nagios & Nagios XI, Oracle Enterprise Manager, HP Operations Manager, IBM Tivoli Netcool/OMNibus, IBM Tivoli® Network Manager, CA Network and Systems Management	Integrations: Microsoft® System Center, VMware® vCenter™, BMC Software Connections: Nagios & Nagios XI, Oracle Enterprise Manager, HP Operations Manager, IBM Tivoli Netcool/OMNibus, IBM Tivoli® Network Manager, CA Network and Systems Management
Net weight	26.5 kg	26.5 kg	26.5 kg
Weight with Package	35.1 kg	35.1 kg	35.1 kg
Security	TPM 1.2/2.0 optional Cryptographically signed firmware Secure Boot System Lockdown Secure erase	TPM 1.2/2.0 optional Cryptographically signed firmware Secure Boot System Lockdown Secure erase	TPM 1.2/2.0 optional Cryptographically signed firmware Secure Boot System Lockdown Secure erase
I/O & Ports	This model is configured 4 x 1GE Front ports: Video, 2 x USB 2.0, available USB 3.0, dedicated iDRAC Direct Micro-USB Rear ports: Video, serial, 2 x USB 3.0, dedicated iDRAC network port Video card: VGA	This model is configured 4 x 1GE Front ports: Video, 2 x USB 2.0, available USB 3.0, dedicated iDRAC Direct Micro-USB Rear ports: Video, serial, 2 x USB 3.0, dedicated iDRAC network port Video card: VGA	This model is configured 4 x 1GE Front ports: Video, 2 x USB 2.0, available USB 3.0, dedicated iDRAC Direct Micro-USB Rear ports: Video, serial, 2 x USB 3.0, dedicated iDRAC network port Video card: VGA
Supported operating systems	This model is installed with Win SVR 2016 global standard system	This model is not configured by default.	This model is not configured by default.
Storage temperature	-	-	-
Working temperature	-	-	-
Working humidity	-	-	-
Embedded NIC	-	-	-
Device Access	-	-	-

Model	DS-VD22D-BHW7	DS-VD22D-BHW15	DS-VD22D-BHW40	DS-VE11D-CHW04	DS-VE11D-CHW01
Image					
Processor	two Intel® Xeon® SP(4114*2)	two Intel® Xeon® SP(4110*2)	two Intel® Xeon® SP (4210R*2)	E-22786 x 1	E2124*1
Memory	64G DDR4 DIMM	64G DDR4 DIMM	16G*6 DDR4 DIMM	64G DDR4 DIMM	16G DDR4 DIMM
storage controllers	PERC H330	PERC H330	PERC H330	H330 x 1	H330 x 1
Drive Bays	S4510 960G*3+S4610 240G*1	1TB 7.2K SATA*2(RAID_1)	1T 7.2K SATA*2(RAID_1) + 1T 7.2K SATA*2(RAID_1)	1T 7.2K SATA x 2 (RAID 1)	1T 7.2K SATA*2
Power supplies	495W(1+1)	495W(1+1)	495W(1+1)	Single 250W (Bronze) power supply	Single 250W (Bronze) power supply
Sizing	Form factor: Rack (2U) Chassis depth: 715.5 mm 715.5 × 482 × 86.8 mm (28.2 × 19.0 × 3.4 inch)	Form factor: Rack (2U) Chassis depth: 715.5 mm 715.5 × 482 × 86.8 mm (28.2 × 19.0 × 3.4 inch)	Form factor: Rack (2U) Chassis depth: 715.5 mm 715.5 × 482 × 86.8 mm (28.2 × 19.0 × 3.4 inch)	Form factor: Rack (1U) Chassis width: 434.00mm (17.08 in) Chassis depth: 595.63mm (23.45 in) [3.5" HDD config] Note: These dimensions do not include: bezel, redundant PSU	Form factor: Rack (1U) Chassis width: 434.00mm (17.08 in) Chassis depth: 595.63mm (23.45 in) [3.5" HDD config] Note: These dimensions do not include: bezel, redundant PSU
Sizing with Package	960 × 610 × 295 mm (37.8 × 24.0 × 11.6 inch)	960 × 610 × 295 mm (37.8 × 24.0 × 11.6 inch)	960 × 610 × 295 mm (37.8 × 24.0 × 11.6 inch)	750 mm × 614 mm × 259 mm (29.53" × 24.17" × 10.2")	750 mm × 614 mm × 259 mm (29.53" × 24.17" × 10.2")
Embedded management	IPMI 2.0 compliant iDRAC9 with Lifecycle Controller (Express, Enterprise) Quick Sync 2 wireless module optional	iDRAC9, Enterprise	iDRAC9, Enterprise	iDRAC9 with Lifecycle Controller (Enterprise)	iDRAC9 with Lifecycle Controller (Enterprise)
Bezel	security bezel	security bezel	security bezel	-	-
OpenManage™ Software	OpenManage Enterprise OpenManage Mobile OpenManage Essentials OpenManage Power Center	OpenManage Enterprise OpenManage Mobile OpenManage Essentials OpenManage Power Center	OpenManage Enterprise OpenManage Mobile OpenManage Essentials OpenManage Power Center	-	-
Integrations and connections	Integrations: Microsoft® System Center, VMware® vCenter™, BMC Software Connections: Nagios & Nagios XI, Oracle Enterprise Manager, HP Operations Manager, IBM Tivoli Netcool/OMNIBus, IBM Tivoli® Network Manager, CA Network and Systems Management	Integrations: Microsoft® System Center, VMware® vCenter™, BMC Software Connections: Nagios & Nagios XI, Oracle Enterprise Manager, HP Operations Manager, IBM Tivoli Netcool/OMNIBus, IBM Tivoli® Network Manager, CA Network and Systems Management	Integrations: Microsoft® System Center, VMware® vCenter™, BMC Software Connections: Nagios & Nagios XI, Oracle Enterprise Manager, HP Operations Manager, IBM Tivoli Netcool/OMNIBus, IBM Tivoli® Network Manager, CA Network and Systems Management	Integrations: Microsoft® System Center VMware® vCenter™ BMC Truesight (available from BMC) Red Hat Ansible Connections: Nagios Core & Nagios XI Micro Focus Operations Manager i (OMI) IBM Tivoli Netcool/OMNIBus	Integrations: Microsoft® System Center VMware® vCenter™ BMC Truesight (available from BMC) Red Hat Ansible Connections: Nagios Core & Nagios XI Micro Focus Operations Manager i (OMI) IBM Tivoli Netcool/OMNIBus
Net weight	26.5 kg	26.5 kg	26.5 kg	12.2kg	12.2kg
Weight with Package	35.1 kg	35.1 kg	35.1 kg	18.5kg	18.5kg
Security	TPM 1.2/2.0 optional Cryptographically signed firmware Secure Boot System Lockdown Secure erase	TPM 1.2/2.0 optional Cryptographically signed firmware Secure Boot System Lockdown Secure erase	TPM 1.2/2.0 optional Cryptographically signed firmware Secure Boot System Lockdown Secure erase	-	-
I/O & Ports	This model is configured 4 x 1GE Front ports: Video, 2 x USB 2.0, available USB 3.0, dedicated iDRAC Direct Micro-USB Rear ports: Video, serial, 2 x USB 3.0, dedicated iDRAC network port Video card: VGA	This model is configured 4 x 1GE Front ports: Video, 2 x USB 2.0 Rear ports: Video, serial, 2 x USB 3.0 Video card: VGA*1	This model is configured 4 x 1GE Front ports: Video, 2 x USB 2.0 Rear ports: Video, serial, 2 x USB 3.0 Video card: VGA*1	-	-
Supported operating systems	This model is not configured by default.	This model is not configured by default	This model is not configured by default	This model is not configured by default	This model is installed with Windows Server 2016 multilingual operating system.
Storage temperature	-	-40°C to +70°C [-40°F to 158 °F]	-40°C to +70°C [-40°F to 158 °F]	-	-
Working temperature	-	+5°C to +35°C (41°F to 95 °F)	+5°C to +35°C (41°F to 95 °F)	-	-
Working humidity	-	8 % to 90 % (without condensation)	8 % to 90 % (without condensation)	-	-
Embedded NIC	-	-	-	2 x 1GbE LOM Network Interface Controller (NIC) ports	2 x 1GbE LOM Network Interface Controller (NIC) ports
Device Access	-	-	-	"Front ports: 1x USB 2.0 Rear ports: 2 x USB 3.0, VGA, serial connector"	Front ports: 1x USB 2.0 Rear ports: 2 x USB 3.0, VGA, serial connector

Thermal

086 HeatPro Series

088 Security Group Cameras

093 Thermographic Group Products

097 Temperature Screening Products



HeatPro Series

Professional Protection Made Simple

Hikvision HeatPro Series Cameras feature Deep Learning thermal video analytics for all-weather perimeter protection, object temperature measurement, and fire detection with real-time alarms. They are easy to configure, making the cameras ideal for SMB applications in residential, retail, parking, museums, data centers, and other verticals.



- > All-weather deterrence and alerts
- > Simple, three-step deployment for perimeter protection
- > Thermal video analytics with Deep Learning human & vehicle classification, reducing maintenance overhead
- > Temperature exception alarms for fire prevention
- > Visual and auditory alarms (offered by /PA models)



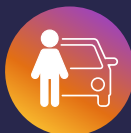

Hikvision HeatPro Series Thermal Cameras Professional Protection Made Simple



Thermal - Single Lens

Model	DS-2TD1117-2PA/3PA/6PA series	DS-2TD2117-3PA/6PA/10PA
Image	 Audible Alarm and Strobe Light	 Audible Alarm and Strobe Light
Sensor (Thermal)	Vanadium Oxide Uncooled Focal Plane Arrays	Vanadium Oxide Uncooled Focal Plane Arrays
NETD	< 40 mk (@25 °C, F# = 1.1)	< 40 mk (@25 °C, F# = 1.1)
Pixel Pitch (Thermal)	17 μm	17 μm
Resolution (Thermal)	160 × 120	160 × 120
Sensor (Optical)	-	-
Max. Resolution (Optical)	-	-
Min. Illumination (Optical)	-	-
Lens	2, 3 or 6 mm	3, 6 or 10 mm
Field of View (Thermal)	2 mm: 90° × 66.4° 3 mm: 50° × 37.2° 6 mm: 25.0° × 18.7°	3 mm: 50° × 37.2° 6 mm: 25.0° × 18.7° 10 mm: 15.96° × 12°
Video Compression	H.265/H.264/MJPEG	H.265/H.264/MJPEG
Frame Rate	25 fps	25 fps
Ingress Protection	IP66	IP66
Pan/Tilt	-	-
Audio Input	1-ch 3.5 mm Mic in/Line in interface. Line input: 2 - 2.4 V [p-p], output impedance: 1 kΩ ± 10%	1-ch 3.5 mm Mic in/Line in interface. Line input: 2 to 2.4 V [p-p], output impedance: 1 kΩ ± 10%
Audio Output	Linear level; impedance: 600 Ω	Linear level; impedance: 600 Ω
Alarm Input	1-ch inputs [0-5 VDC]	2-ch inputs [0-5 VDC]
Alarm Output	1-ch relay outputs, alarm response actions configurable	2-ch relay outputs, alarm response actions configurable
Power	12 VDC ± 20% PoE (802.3af)	12 VDC ± 20% PoE (802.3af)
Environmental Requirement	From -40 °C to 65 °C [-40 °F to 149 °F], Humidity: 95% or less	From -40 °C to 65 °C [-40 °F to 149 °F], Humidity: 95% or less
VCA	Line Crossing, Intrusion, Region Entrance, Region Exiting	Line Crossing, Intrusion, Region Entrance, Region Exiting
Fire Detection	Dynamic fire detection, up to 10 fire points detectable.	Dynamic fire detection, up to 10 fire points detectable.
Temperature Measuring Range	-20 °C to +150 °C [-4 °F to +302 °F]	-20 °C to +150 °C [-4 °F to +302 °F]
Temperature Accuracy	± 8 °C (± 14.4 °F)	± 8 °C (± 14.4 °F)

Thermal - Dual Lens

Model	DS-2TD1217-2PA/3PA/6PA	DS-2TD2617-3PA/6PA/10PA
Image	 Audible Alarm and Strobe Light	 Audible Alarm and Strobe Light
Sensor (Thermal)	Vanadium Oxide Uncooled Focal Plane Arrays	Vanadium Oxide Uncooled Focal Plane Arrays
NETD	< 40 mk (@25 °C, F# = 1.1)	< 40 mk (@25 °C, F# = 1.1)
Pixel Pitch (Thermal)	17 μm	17 μm
Resolution (Thermal)	160 × 120 (the resolution of output image is 320 × 240)	160 × 120 (the resolution of output image is 320 × 240)
Sensor (Optical)	1/2.7" Progressive Scan CMOS	1/2.7" Progressive Scan CMOS
Max. Resolution (Optical)	2688 × 1520	2688 × 1520
Min. Illumination (Optical)	-2PA: Color: 0.0176 Lux @ (F2.25, AGC ON), B/W: 0.0035 Lux @ (F2.25, AGC ON) -3PA/6PA: Color: 0.0089 Lux @ (F1.6, AGC ON), B/W: 0.0018 Lux @ (F1.6, AGC ON)	Color: 0.0089 Lux @ (F1.6, AGC ON), B/W: 0.0018 Lux @ (F1.6, AGC ON)
Lens	Thermal: 2, 3 or 6 mm Optical: 2, 4 or 6 mm	Thermal: 3, 6 or 10 mm Optical: 4, 6 or 8 mm
Field of View (Thermal)	2 mm: 90° × 66.4° 3 mm: 50° × 37.2° 6 mm: 25.0° × 18.7°	3 mm: 50° × 37.2° 6 mm: 25.0° × 18.7° 10 mm: 15.96° × 12°
Video Compression	H.265/H.264/MJPEG	H.265/H.264/MJPEG
Frame Rate	25 fps	25 fps
Ingress Protection	IP66	IP66
Pan/Tilt	-	-
Audio Input	1-ch 3.5 mm Mic in/Line in interface. Line input: 2 - 2.4 V [p-p], output impedance: 1 kΩ ± 10%	1-ch 3.5 mm Mic in/Line in interface. Line input: 2 to 2.4 V [p-p], output impedance: 1 kΩ ± 10%
Audio Output	Linear level; impedance: 600 Ω	Linear level; impedance: 600 Ω
Alarm Input	1-ch inputs [0-5 VDC]	2-ch inputs [0-5 VDC]
Alarm Output	1-ch relay outputs, alarm response actions configurable	2-ch relay outputs, alarm response actions configurable
Power	12 VDC ± 20% PoE (802.3af)	12 VDC ± 20% PoE (802.3af)
Environmental Requirement	From -40 °C to 65 °C [-40 °F to 149 °F]; Humidity: 95% or less	From -40 °C to 65 °C [-40 °F to 149 °F]; Humidity: 95% or less
VCA	Line Crossing, Intrusion, Region Entrance, Region Exiting	Line Crossing, Intrusion, Region Entrance, Region Exiting
Fire Detection	Dynamic fire detection, up to 10 fire points detectable.	Dynamic fire detection, up to 10 fire points detectable.
Temperature Measuring Range	-20 °C to +150 °C [-4 °F to +302 °F]	-20 °C to +150 °C [-4 °F to +302 °F]
Temperature Accuracy	± 8 °C (± 14.4 °F)	± 8 °C (± 14.4 °F)

Security Group Cameras





See the World in a New Way





Hikvision's Thermal Security Cameras feature Deep Learning thermal video analytics for all-weather perimeter protection, object temperature measurement, and fire detection with real-time alarms. They feature expert design for high value infrastructure applications in power stations, substations, airports, warehouses, and other verticals.





- > All-weather deterrence and alerts
- > Thermal video analytics with Deep Learning human & vehicle classification, reducing maintenance overhead
- > Temperature exception alarms for fire prevention
- > Multiple model options covering short and long range demands







Thermal - Single Lens

Model	DS-2TD2137-4P/7P/10P/15P/25P/35P	DS-2TD2137-4PY/7PY/10PY/15PY/25PY/35PY	DS-2TD2167-7P/15P/25P/35P	DS-2TD2167-7PY/15PY/25PY/35PY	DS-2TD2367-50P/75P/100P
Image		 HOT		 HOT	 NEW
		Anti-corrosion		Anti-corrosion	
Sensor (Thermal)	Vanadium Oxide Uncooled Focal Plane Arrays	Vanadium Oxide Uncooled Focal Plane Arrays	Vanadium Oxide Uncooled Focal Plane Arrays	Vanadium Oxide Uncooled Focal Plane Arrays	Vanadium Oxide Uncooled Focal Plane Arrays
NETD	< 35 mk (@25°C, F#=1.0)	< 35 mk (@25°C, F#=1.0)	< 35 mk (@25°C, F#=1.0)	< 35 mk (@25°C, F#=1.0)	< 35 mk (@25°C, F#=1.0)
Pixel Pitch (Thermal)	17 μm	17 μm	17 μm	17 μm	17 μm
Resolution (Thermal)	384 × 288	384 × 288	640 × 512	640 × 512	640 × 512
Sensor (Optical)	-	-	-	-	-
Max. Resolution (Optical)	-	-	-	-	-
Min. Illumination (Optical)	-	-	-	-	-
Lens	7, 10, 15, 25 or 35 mm	4, 7, 10, 15, 25 or 35 mm	7, 15, 25 or 35 mm	7, 15, 25 or 35 mm	50, 75 or 100 mm
Field of View (Thermal)	7 mm: 60° × 44.1° 10 mm: 37.5° × 28.5° 15 mm: 24.5° × 18.5° 25 mm: 14.9° × 11.2° 35 mm: 10.7° × 8°	4 mm: 90° × 65.3° 7 mm: 60° × 44.1° 10 mm: 37.5° × 28.5° 15 mm: 24.5° × 18.5° 25 mm: 14.9° × 11.2° 35 mm: 10.7° × 8°	7 mm: 88.5° × 73.2° 15 mm: 42.5° × 33.6° 25 mm: 24.55° × 19.75° 35 mm: 17.67° × 14.18°	7 mm: 88.5° × 73.2° 15 mm: 42.5° × 33.6° 25 mm: 24.55° × 19.75° 35 mm: 17.67° × 14.18°	50 mm: 12.4° × 10° 75 mm: 8.3° × 6.6° 100 mm: 6.22° × 4.96°
Video Compression	H.265/H.264/MJPEG	H.265/H.264/MJPEG	H.265/H.264/MJPEG	H.265/H.264/MJPEG	H.265/H.264/MJPEG
Frame Rate	25 fps	25 fps	25 fps	25 fps	25 fps
Ingress Protection	IP66	IP66	IP66	IP66	IP66
Pan/Tilt	-	-	-	-	-
Audio Input	1 3.5mm Mic in/Line in interface. Line input: 2-2.4 V(p-p), output impedance:1 KΩ ± 10%	1 3.5mm Mic in/Line in interface. Line input: 2-2.4 V(p-p), output impedance:1 KΩ ± 10%	1 3.5mm Mic in/Line in interface. Line input: 2-2.4 V(p-p), output impedance:1 KΩ ± 10%	1 3.5mm Mic in/Line in interface. Line input: 2-2.4 V(p-p), output impedance:1 KΩ ± 10%	1 3.5mm Mic in/Line in interface. Line input: 2-2.4 V(p-p), output impedance:1 KΩ ± 10%
Audio Output	Linear Level; Impedance: 600 Ω	Linear Level; Impedance: 600 Ω	Linear Level; Impedance: 600 Ω	Linear Level; Impedance: 600 Ω	Linear Level; Impedance: 600 Ω
Alarm Input	2-ch Input (0-5 VDC)	2-ch inputs (0-5 VDC)	2-ch inputs (0-5 VDC)	2-ch inputs (0-5 VDC)	2-ch inputs (0-5 VDC)
Alarm Output	2-ch relay outputs, alarm response actions configurable	2-ch relay outputs, alarm response actions configurable	2-ch relay outputs, alarm response actions configurable	2-ch relay outputs, alarm response actions configurable	2-ch relay outputs, alarm response actions configurable
Power	24 VAC ± 25%, 12 VDC ± 25%; PoE (802.3af, class 3)	24 VAC ± 25%, 12 VDC ± 25%; PoE (802.3af, class 3)	12 VDC ± 20% PoE (802.3af) 24 VAC ± 25%	12 VDC ± 20% PoE (802.3af) 24 VAC ± 25%	12 VDC ± 20% PoE (802.3af) 24 VAC ± 25%
Environmental Requirement	Temperature: -40 °C to 65 °C (-40 °F to 149 °F) Humidity: 90% or less	Temperature: -40 °C to 65 °C (-40 °F to 149 °F) Humidity: 90% or less	Temperature: -40 °C to 65 °C (-40 °F to 149 °F) Humidity: 90% or less	Temperature: -40 °C to 65 °C (-40 °F to 149 °F) Humidity: 90% or less	Temperature: -40 °C to 65 °C (-40 °F to 149 °F) Humidity: 90% or less
VCA	Line Crossing, Intrusion, Region Entrance, Region Exiting	Line Crossing, Intrusion, Region Entrance, Region Exiting	Line Crossing, Intrusion, Region Entrance, Region Exiting	Line Crossing, Intrusion, Region Entrance, Region Exiting	Line Crossing, Intrusion, Region Entrance, Region Exiting
Fire Detection	Dynamic fire detection, up to 10 fire points detectable.	Dynamic fire detection, up to 10 fire points detectable.	Dynamic fire detection, up to 10 fire points detectable.	Dynamic fire detection, up to 10 fire points detectable.	Dynamic fire detection, up to 10 fire points detectable.
Temperature Mesuring Range	-20 °C to +150 °C (-4 °F to +302 °F)	-20 °C to +150 °C (-4 °F to +302 °F)	-20 °C to +150 °C (-4 °F to +302 °F)	-20 °C to +150 °C (-4 °F to +302 °F)	-20 °C to +150 °C (-4 °F to +302 °F)
Temperature Accuracy	± 8 °C (± 14.4 °F)	± 8 °C (± 14.4 °F)	± 8 °C (± 14.4 °F)	± 8 °C (± 14.4 °F)	± 8 °C (± 14.4 °F)

Model	DS-2TD2637-10P/15P/25P/35P	DS-2TD2667-15P/25P/35P	DS-2TX3742-10A/15A/25A/35A/P	DS-2TX3742-10P/15P/25P/35P/P	DS-2TD4137-25W/50W
Image					
Sensor (Thermal)	Vanadium Oxide Uncooled Focal Plane Arrays	Vanadium Oxide Uncooled Focal Plane Arrays	Vanadium Oxide Uncooled Focal Plane Arrays	Vanadium Oxide Uncooled Focal Plane Arrays	Vanadium Oxide Uncooled Focal Plane Arrays
NETD	≤ 35 mk (@25 °C, F# = 1.0)	< 35 mk (@25 °C, F# = 1.0)	< 35 mk (@25 °C, F# = 1.0)	< 35 mk (@25 °C, F# = 1.0)	< 40 mk (@25 °C, F# = 1.0)
Pixel Pitch (Thermal)	17 μm	17 μm	17 μm	17 μm	17 μm
Resolution (Thermal)	384 × 288	640 × 512	384 × 288	384 × 288	384 × 288
Sensor (Optical)	1/2.7" Progressive Scan CMOS	1/2.7" Progressive Scan CMOS	1/2.7" Progressive Scan CMOS	1/2.7" Progressive Scan CMOS	1/1.8" Progressive Scan CMOS
Max. Resolution (Optical)	2688 × 1520	2688 × 1520	2688 × 1520	2688 × 1520	2688 × 1520
Min. Illumination (Optical)	Color: 0.0089 Lux @(F1.6, AGC ON), B/W: 0.0018 Lux @(F1.6, AGC ON)	Color: 0.0089 Lux @(F1.6, AGC ON), B/W: 0.0018 Lux @(F1.6, AGC ON)	Color: 0.0089 Lux @(F1.6, AGC ON), B/W: 0.0018 Lux @(F1.6, AGC ON)	Color: 0.0089 Lux @(F1.6, AGC ON), B/W: 0.0018 Lux @(F1.6, AGC ON)	"Color: 0.005 Lux @ (F1.3, AGC ON) B/W: 0.001 Lux @ (F1.3, AGC ON)"
Lens	Thermal: 10 mm, 15 mm, 25 mm or 35 mm Optical: 4mm, 6mm, 12mm or 15mm	Thermal: 15 mm, 25 mm or 35 mm Optical: 4mm, 6mm, 8mm	Thermal: 10,15,25 or 35 mm Optical: 6.0-252 mm	Thermal:10,15,25 or 35 mm Optical: 6.0-252 mm	"Thermal: 25 or 50 mm Optical: 6-240 mm "
Field of View (Thermal)	10mm: 37.5° × 28.5° 15mm: 24.5° × 18.5° 25mm: 14.9° × 11.2° 35mm: 10.7° × 8.0°	15mm: 42.5° × 33.6° 25mm: 24.55° × 19.75° 35mm: 17.67° × 14.18° "	10mm: 37.5° × 28.5° 15mm: 24.5° × 18.5° 25mm: 14.9° × 11.2° 35mm: 10.7° × 8°	10mm: 37.5° × 28.5° 15mm: 24.5° × 18.5° 25mm: 14.9° × 11.2° 35mm: 10.7° × 8°	25 mm: 14.9° × 11.2° 50 mm: 7.5° × 5.6°
Video Compression	H.265/H.264/MJPEG	H.265/H.264/MJPEG	H.265/H.264/MJPEG	H.265/H.264/MJPEG	H.265/H.264/MJPEG
Frame Rate	25fps	25fps	25fps	25fps	"Thermal: 50fps Optical: 25fps"
Ingress Protection	IP66	IP66	IP66	IP66	IP66
Pan/Tilt	-	-	Pan: 360°, Tilt: -20° to 90°	Pan: 360°, Tilt: -20° to 90°	Pan: 360° Continuous Rotate; Tilt: From -20° to + 90° (auto flip)
Audio Input	1, 3.5 mm Mic in/Line in interface. Line input: 2 to 2.4 V (p-p), output impedance: 1 KΩ ± 10%	1, 3.5 mm Mic in/Line in interface. Line input: 2 to 2.4 V (p-p), output impedance: 1 KΩ ± 10%	1-ch 3.5 mm Mic in/Line in interface. Line input: 2-2.4V(p-p), output impedance: 1 KΩ ± 10%	"1-ch 3.5 mm Mic in/Line in interface. Line input: 2-2.4V(p-p), output impedance: 1 KΩ ± 10%"	1-ch 3.5 mm Mic in/Line in interface. Line input: 2-2.4V(p-p), output impedance: 1 KΩ ± 10%
Audio Output	Linear level, impedance: 600 Ω	Linear level, impedance: 600 Ω	Linear Level; Impedance: 600 Ω	Linear Level; Impedance: 600 Ω	Linear Level; Impedance: 600 Ω
Alarm Input	2-ch inputs (0-5 VDC)	2-ch inputs (0-5 VDC)	Up to 7-ch inputs (0-5 VDC)	Up to 7-ch inputs (0-5 VDC)	Up to 7-ch inputs (0-5 VDC)
Alarm Output	2-ch relay outputs, alarm response actions configurable	2-ch relay outputs, alarm response actions configurable	2-ch relay outputs, alarm response actions configurable	2-ch relay outputs, alarm response actions configurable	2-ch relay outputs, alarm response actions configurable
Power	24 VAC ± 25%, 12 VDC ± 25%, two-core terminal block PoE (802.3af, class 3)	24 VAC ± 25%, 12 VDC ± 25%; PoE (802.3af, class 3)	24 VAC ± 25%	24 VAC ± 25%	24 VAC ± 25%
Environmental Requirement	Temperature: -40 °C to 65 °C (-40 °F to 149 °F) Humidity: 95% or less	Temperature: -40 °C to 65 °C (-40 °F to 149 °F) Humidity: 95% or less	From -40 °C to 65 °C (-40 °F to 149 °F); Humidity: 90% or less	From -40 °C to 65 °C (-40 °F to 149 °F); Humidity: 90% or less	From -40 °C to 65 °C (-40 °F to 149 °F); Humidity: 95% or less
VCA	Line Crossing, Intrusion, Region Entrance, Region Exiting	Line Crossing, Intrusion, Region Entrance, Region Exiting	Line Crossing, Intrusion, Region Entrance, Region Exiting	Line Crossing, Intrusion, Region Entrance, Region Exiting	Line Crossing, Intrusion, Region Entrance, Region Exiting
Fire Detection	Dynamic fire detection, up to 10 fire points detectable.	Dynamic fire detection, up to 10 fire points detectable.	Dynamic fire detection, up to 10 fire points detectable.	Dynamic fire detection, up to 10 fire points detectable.	Dynamic fire detection, up to 10 fire points detectable.
Temperature Measuring Range	-20 °C to +150 °C (-4 °F to +302 °F)	-20 °C to +150 °C (-4 °F to +302 °F)	-20 °C to 150 °C (-4 °F to +302 °F)	-20 °C to 150 °C (-4 °F to +302 °F)	-20 °C to 150 °C (-4 °F to +302 °F)
Temperature Accuracy	± 8 °C (± 14.4 °F)	± 8 °C (± 14.4 °F)	± 8 °C (± 14.4 °F)	± 8 °C (± 14.4 °F)	± 8 °C (± 14.4 °F)

Model	DS-2TD4137-25WY/50WY	DS-2TD4167-25W/50W	DS-2TD4167-25WY/50WY	DS-2TD4237-10V2/25V2	DS-2TD6236-50H2LV2/75C2LV2
Image	 HOT Anti-corrosion		 HOT Anti-corrosion		
Sensor (Thermal)	Vanadium Oxide Uncooled Focal Plane Arrays	Vanadium Oxide Uncooled Focal Plane Arrays	Vanadium Oxide Uncooled Focal Plane Arrays	Vanadium Oxide Uncooled Focal Plane Arrays	Vanadium Oxide Uncooled Focal Plane Arrays
NETD	< 40 mk (@25°C, F#=1.0)	< 40 mk (@25°C, F#=1.0)	< 40 mk (@25°C, F#=1.0)	< 40 mk (@25°C, F#=1.0)	< 40 mk (@25°C, F#=1.0)
Pixel Pitch (Thermal)	17 µm	17 µm	17 µm	17 µm	17 µm
Resolution (Thermal)	384 × 288	640 × 512	640 × 512	384 × 288	384 × 288
Sensor (Optical)	1/1.8" Progressive Scan CMOS	1/1.8" Progressive Scan CMOS	1/1.8" Progressive Scan CMOS	1/2.8" Progressive Scan CMOS	H: 1/1.9" Progressive Scan CMOS C: 1/2.8" Progressive Scan CMOS
Max. Resolution (Optical)	2688 × 1520	2688 × 1520	2688 × 1520	1920 × 1080	1920 × 1080
Min. Illumination (Optical)	Color: 0.005 Lux @ (F1.3, AGC ON) B/W: 0.001 Lux @ (F1.3, AGC ON)	Color: 0.005 Lux @ (F1.3, AGC ON) B/W: 0.001 Lux @ (F1.3, AGC ON)	Color: 0.005 Lux @ (F1.3, AGC ON) B/W: 0.001 Lux @ (F1.3, AGC ON)	Color: 0.05 lux @ (F1.2, AGC ON) B/W: 0.01 lux @ (F1.2, AGC ON)	H: Color: 0.002 lux @ (F1.5, AGC ON) H: B/W: 0.0002 lux @ (F1.5, AGC ON) C: Color: 0.05 lux @ (F1.8, AGC ON) C: B/W: 0.01 lux @ (F1.8, AGC ON)
Lens	Thermal: 25 or 50 mm Optical: 6-240 mm	Thermal: 25 or 50 mm Optical: 6-240 mm	Thermal: 25 or 50 mm Optical: 6-240 mm	Thermal: 10 or 25 mm Optical: 4.8-153 mm	Thermal: 50 or 75 mm Optical: 5.7-205.2 or 6.7-330 mm
Field of View (Thermal)	25 mm: 14.9° × 11.2° 50 mm: 7.5° × 5.6°	25 mm: 24.5° × 19.7° 50 mm: 7.5° × 5.6°	25 mm: 24.5° × 19.7° 50 mm: 7.5° × 5.6°	10 mm: 37.7° × 28.7° 25 mm: 14.88° × 11.19°	50 mm: 7.47° × 5.61° 75 mm: 4.98° × 3.74°
Video Compression	H.265/H.264/MJPEG	H.265/H.264/MJPEG	H.265/H.264/MJPEG	H.265/H.264	H.265/H.264, H.265+/H.264+ encoding with Baseline/Main/High Profile
Frame Rate	Thermal: 50fps Optical: 25fps*	Thermal: 50fps Optical: 25fps	Thermal: 50fps Optical: 25fps	25 fps	25 fps
Ingress Protection	IP66	IP66	IP66	IP66	IP66 Standard, TVS 6000V Lightning protection, surge protection, voltage transient protection
Pan/Tilt	Pan: 360° Continuous Rotate; Tilt: From -20° to +90° (auto flip)	Pan: 360° Continuous Rotate; Tilt: From -20° to +90° (auto flip)	Pan: 360° Continuous Rotate; Tilt: From -20° to +90° (auto flip)	Pan: 360° Continuous Rotate; Tilt: From -5° to +90° (auto flip)	Pan: 360° Continuous Rotate; Tilt: From -90° to +40° (auto flip)
Audio Input	1-ch 3.5 mm Mic in/Line in interface. Line input: 2-2.4V(p-p), output impedance: 1 KΩ ± 10%	1-ch 3.5 mm Mic in/Line in interface. Line input: 2-2.4V(p-p), output impedance: 1 KΩ ± 10%	1-ch 3.5 mm Mic in/Line in interface. Line input: 2-2.4V(p-p), output impedance: 1 KΩ ± 10%	1-ch 3.5 mm Mic in/Line in interface. Line input: 2-2.4V(p-p), output impedance: 1 KΩ ± 10%	1-ch 3.5 mm Mic in/Line in interface. Line input: 2-2.4V(p-p), output impedance: 1 KΩ ± 10%
Audio Output	Linear Level; Impedance: 600 Ω	Linear Level; Impedance: 600 Ω	Linear Level; Impedance: 600 Ω	Linear Level; Impedance: 600 Ω	Linear Level; Impedance: 600 Ω
Alarm Input	Up to 7-ch inputs (0-5 VDC)	Up to 7-ch inputs (0-5 VDC)	Up to 7-ch inputs (0-5 VDC)	Up to 7-ch inputs (0-5 VDC)	Up to 7-ch inputs (0-5 VDC)
Alarm Output	2-ch relay outputs, alarm response actions configurable	2-ch relay outputs, alarm response actions configurable	2-ch relay outputs, alarm response actions configurable	2-ch relay outputs, alarm response actions configurable	2-ch relay outputs, alarm response actions configurable
Power	24 VAC ± 25%	24 VAC ± 25%	24 VAC ± 25%	24 VAC ± 25%	24 VAC ± 25%
Environmental Requirement	From -40 °C to 65 °C (-40 °F to 149 °F); Humidity: 95% or less	From -40 °C to 65 °C (-40 °F to 149 °F); Humidity: 95% or less	From -40 °C to 65 °C (-40 °F to 149 °F); Humidity: 95% or less	From -40 °C to 65 °C (-40 °F to 149 °F); Humidity: 90% or less	From -40 °C to 65 °C (-40 °F to 149 °F); Humidity: 90% or less
VCA	Line Crossing, Intrusion, Region Entrance, Region Exiting	Line Crossing, Intrusion, Region Entrance, Region Exiting	Line Crossing, Intrusion, Region Entrance, Region Exiting	Line Crossing, Intrusion, Region Entrance, and Region Exiting	Line Crossing, Intrusion, Region Entrance, and Region Exiting
Fire Detection	Dynamic fire detection, up to 10 fire points detectable.	Dynamic fire detection, up to 10 fire points detectable.	Dynamic fire detection, up to 10 fire points detectable.	Dynamic fire detection, up to 10 fire points detectable.	Dynamic fire point detection, up to 10 fire points detectable.
Temperature Measuring Range	-20° C to 150° C (-4 °F to +302° F)	-20° C to 150° C (-4 °F to +302° F)	-20° C to 150° C (-4 °F to +302° F)	-20 °C to +150 °C (-4 °F to +302 °F)	-20° C to 150° C (-4 °F to +302° F)
Temperature Accuracy	± 8 °C (± 14.4 °F)	± 8 °C (± 14.4 °F)	± 8 °C (± 14.4 °F)	± 8 °C (± 14.4 °F)	± 8 °C (± 14.4 °F)

Model	DS-2TD6267-50H4LW/75C4LW/100C4LW	DS-2TD6267-75C4LWY/100C4LWY	DS-2TD8167-150ZC4FW/150ZE2FW/190ZE2FW/230Z62FW/	DS-2TD8167-190ZE2FLW/230Z62FLW	DS-2TD8167-190ZE2FWY/230Z62FWY
Image					
Sensor (Thermal)	Vanadium Oxide Uncooled Focal Plane Arrays	Vanadium Oxide Uncooled Focal Plane Arrays	Vanadium Oxide Uncooled Focal Plane Arrays	Vanadium Oxide Uncooled Focal Plane Arrays	Vanadium Oxide Uncooled Focal Plane Arrays
NETD	< 35 mk (@25°C, F#=1.0)	< 35 mk (@25°C, F#=1.0)	< 35 mk (@25°C, F#=1.0)	< 35 mk (@25°C, F#=1.0)	< 35 mk (@25°C, F#=1.0)
Pixel Pitch (Thermal)	17 µm	17 µm	17 µm	17 µm	17 µm
Resolution (Thermal)	640 × 512	640 × 512	640 × 512	640 × 512	640 × 512
Sensor (Optical)	1/1.8" Progressive Scan CMOS	1/1.8" Progressive Scan CMOS	1/1.8" Progressive Scan CMOS	1/1.8" Progressive Scan CMOS	1/1.8" Progressive Scan CMOS
Max. Resolution (Optical)	2688 × 1520	2688 × 1520	-C: 2688 × 1520 -E: 1920 × 1080	1920 × 1080	1920 × 1080
Min. Illumination (Optical)	Color: 0.005 Lux @ (F1.3, AGC ON) B/W: 0.001 Lux @ (F1.3, AGC ON)	Color: 0.005 Lux @ (F1.3, AGC ON) B/W: 0.001 Lux @ (F1.3, AGC ON)	-C: Color: 0.0005 lux @ (F1.5, AGC ON) -C: B/W: 0.0001 lux @ (F1.5, AGC ON) -E: Color: 0.005 lux @ (F3.5, AGC ON) -E: B/W: 0.0005 lux @ (F3.5, AGC ON)	Color: 0.005 lux @ (F3.5, AGC ON) B/W: 0.0005 lux @ (F3.5, AGC ON)	Color: 0.005 lux @ (F3.5, AGC ON) B/W: 0.0005 lux @ (F3.5, AGC ON)
Lens	Thermal: 50, 75 or 100 mm Optical: 6 to 336 mm	Thermal: 75 or 100 mm Optical: 6 to 336 mm	Thermal: 150 / 190 / 230 mm Optical: -C: 6.7-330 mm -E: 12.5-775 mm -G: 16.7-1000 mm	Thermal: 190 or 230 mm Optical: 12.5-775 / 16.7-1000 mm	Thermal: 190 or 230 mm Optical: 12.5-775 / 16.7-1000 mm
Field of View (Thermal)	50 mm: 12.42° × 9.95° 75 mm: 8.3° × 6.64° 100 mm: 6.23° × 4.98°	75 mm: 8.3° × 6.64° 100 mm: 6.23° × 4.98°	150 mm: 20.56° × 16.51° 190 mm: 17.19° × 13.79° 230 mm: 26.61° × 21.43°	190 mm: 17.19° × 13.79° 230 mm: 26.61° × 21.43°	190 mm: 32.13° × 18.4° 230 mm: 24.33° × 13.83°
Video Compression	H.265/H.264/MJPEG	H.265/H.264/MJPEG	H.265/H.264/MJPEG	H.265/H.264/MJPEG	H.265/H.264/MJPEG
Frame Rate	25 fps	25 fps	25 fps	25 fps	25 fps
Ingress Protection	IP66	IP66	IP66	IP66	IP66
Pan/Tilt	Pan: 360° Continuous Rotate; Tilt: From -90° to +40° (auto flip)	Pan: 360° Continuous Rotate; Tilt: From -90° to +40° (auto flip)	Pan: 360° Continuous Rotate; Tilt: From -45° to +45° (auto flip)	Pan: 360° Continuous Rotate; Tilt: From -45° to +45° (auto flip)	Pan: 360° Continuous Rotate; Tilt: From -45° to +45° (auto flip)
Audio Input	1-ch 3.5 mm Mic in/Line in interface. Line input: 2-2.4V(p-p), output impedance: 1 KΩ ± 10%	1-ch 3.5 mm Mic in/Line in interface. Line input: 2-2.4V(p-p), output impedance: 1 KΩ ± 10%	1-ch 3.5 mm Mic in/Line in interface. Line input: 2-2.4V(p-p), output impedance: 1KΩ ± 10%	1-ch 3.5 mm Mic in/Line in interface. Line input: 2-2.4V(p-p), output impedance: 1KΩ ± 10%	1-ch 3.5 mm Mic in/Line in interface. Line input: 2-2.4V(p-p), output impedance: 1KΩ ± 10%
Audio Output	Linear Level; Impedance: 600 Ω	Linear Level; Impedance: 600 Ω	Linear Level; Impedance: 600 Ω	Linear Level; Impedance: 600 Ω	Linear Level; Impedance: 600 Ω
Alarm Input	Up to 7-ch inputs (0-5 VDC)	Up to 7-ch inputs (0-5 VDC)	Up to 7-ch inputs (0-5 VDC)	Up to 7-ch inputs (0-5 VDC)	Up to 7-ch inputs (0-5 VDC)
Alarm Output	2-ch relay outputs, alarm response actions configurable	2-ch relay outputs, alarm response actions configurable	2-ch relay outputs, alarm response actions configurable	2-ch relay outputs, alarm response actions configurable	2-ch relay outputs, alarm response actions configurable
Power	24 VAC ± 25%	24 VAC ± 25%	48 VDC, 220 W	48 VDC, 220 W	48 VDC, 220 W
Environmental Requirement	From -40 °C to 65 °C (-40 °F to 149 °F); Humidity: 90% or less	From -40 °C to 65 °C (-40 °F to 149 °F); Humidity: 90% or less	From -40 °C to 65 °C (-40 °F to 149 °F); Humidity: 95% or less	From -40 °C to 65 °C (-40 °F to 149 °F); Humidity: 95% or less	From -40 °C to 65 °C (-40 °F to 149 °F); Humidity: 95% or less
VCA	Line Crossing, Intrusion, Region Entrance, Region Exiting	Line Crossing, Intrusion, Region Entrance, Region Exiting	Line Crossing, Intrusion, Region Entrance, Region Exiting	Line Crossing, Intrusion, Region Entrance, Region Exiting	Line Crossing, Intrusion, Region Entrance, Region Exiting
Fire Detection	Dynamic fire detection, up to 10 fire points detectable.	Dynamic fire detection, up to 10 fire points detectable.	Dynamic fire detection, up to 10 fire points detectable.	Dynamic fire detection, up to 10 fire points detectable.	Dynamic fire detection, up to 10 fire points detectable.
Temperature Mesuring Range	-20° C - 150° C (-4 °F to +302°F)	-20° C - 150° C (-4 °F to +302°F)	-20° C - 150° C (-4 °F to +302°F)	-20° C - 150° C (-4 °F to +302°F)	-20° C - 150° C (-4 °F to +302°F)
Temperature Accuracy	± 8 °C (± 14.4 °F)	± 8 °C (± 14.4 °F)	± 8 °C (± 14.4 °F)	± 8 °C (± 14.4 °F)	± 8 °C (± 14.4 °F)

Thermography Group Products





Any Moment, Any Condition

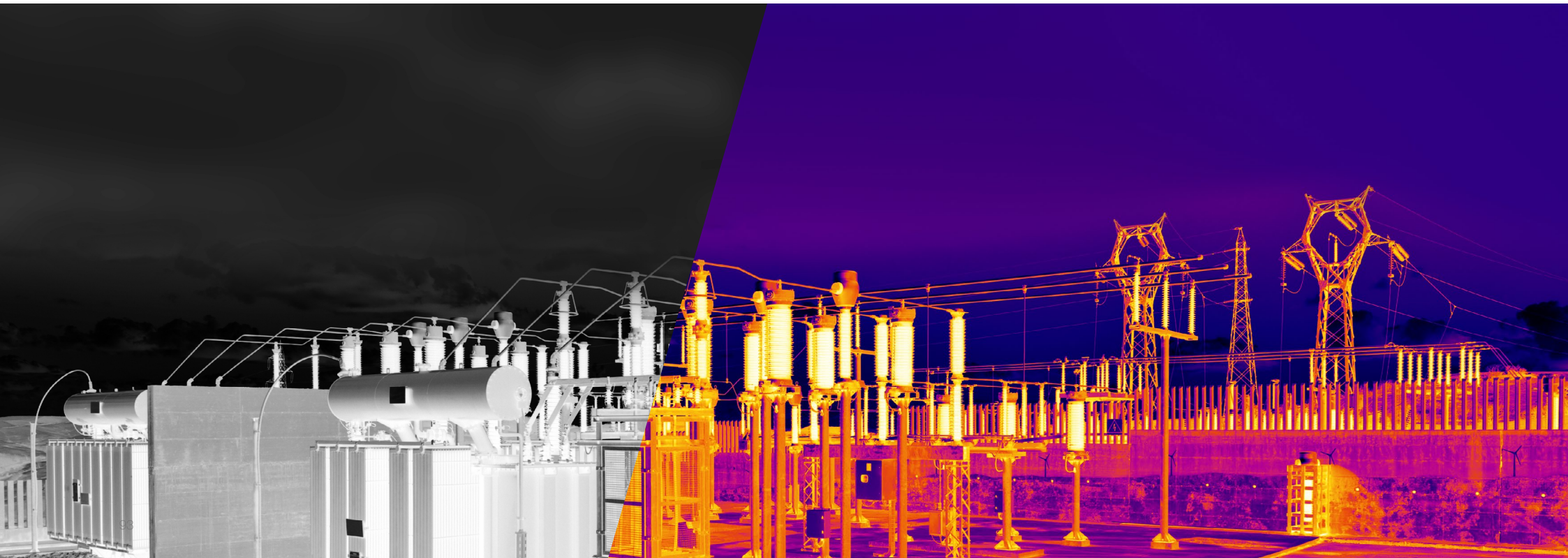



Hikvision's Thermographic Cameras have been used widely for temperature detection in regions of interest, inspection on potential heat sources, and failure detection in noncontact electromechanical systems. They meet high demands for substations, hydropower stations, waste treatment plants, manufacturing workshops, and similar applications.





- › Accurate temperature measurement, up to ± 2 °C (± 6 °F) or ± 2 %
- › 24/7 real-time measurement with instant alarms on temperature anomalies
- › Deep Learning algorithm reduces false alarms from forklifts, shadows, etc.
- › Various types of measuring rules for detection and recording flexibility
- › Continuous and consistent temperature data



Thermography

Model	DS-2TD2137T-4P/7P	DS-2TD2167T-7/P	DS-2TD2466T-25X	DS-2TD2637T-10P/15P	DS-2TD2667T-15/P
Image			 Explosion-proof	 -HOT	 -HOT
Thermal Camera Sensor	Vanadium Oxide Uncooled Focal Plane Arrays	Vanadium Oxide Uncooled Focal Plane Arrays	Vanadium Oxide Uncooled Focal Plane Arrays	Vanadium Oxide Uncooled Focal Plane Arrays	Vanadium Oxide Uncooled Focal Plane Arrays
NETD	< 35 mk (@25°C,F#=1.0)	< 35 mk (@25°C,F#=1.0)	< 40 mk (@25°C,F#=1.0)	< 35 mk (@25°C,F#=1.0)	< 35 mk (@25°C,F#=1.0)
Pixel Pitch (Thermal)	17 μm	17 μm	17 μm	17 μm	17 μm
Max. Resolution (Thermal)	384 × 288	640 × 512	640 × 512	384 × 288	640 × 512
Thermal Lens	4.4 or 6.5 mm	6.5 mm	25 mm	9.7 or 15 mm	15mm
Optical Camera Sensor	/	/	/	1/2.7" Progressive Scan CMOS	1/2.7" Progressive Scan CMOS
Max. Resolution (Optical)	/	/	/	2688 × 1520	2688 × 1520
Min. Illumination	/	/	/	Color: 0.0089 Lux @(F1.6, AGC ON), B/W: 0.0018 Lux @(F1.6, AGC ON)	Color: 0.0089 Lux @(F1.6, AGC ON), B/W: 0.0018 Lux @(F1.6, AGC ON)
Field of View (Thermal)	4 mm: 90° × 65.3° 7 mm: 60° × 44.1°	7 mm: 88.5° × 73.2°	25 mm: 24.55° × 19.75°	10 mm: 37.5° × 28.5° 15 mm: 42.5° × 33.6°	15 mm: 24.5° × 18.5°
Video Compression	H.265/H.264/MJPEG	H.265/H.264/MJPEG	H.265/H.264/MJPEG	H.265/H.264/MJPEG	H.265/H.264/MJPEG
Frame Rate	25 fps	25 fps	50 fps	25 fps	25 fps
Ingress Protection	IP66	IP66	IP66	IP66	IP66
Pan/Tilt	/	/	/	/	/
Audio Input	1-ch 3.5mm Mic in/Line in interface. Line input: 2-2.4 V(p-p), output impedance: 1 KΩ ± 10%	1-ch 3.5mm Mic in/Line in interface. Line input: 2-2.4 V(p-p), output impedance: 1 KΩ ± 10%	1-ch 3.5mm Mic in/Line in interface. Line input: 2-2.4 V(p-p), output impedance: 1 KΩ ± 10%	1-ch 3.5mm Mic in/Line in interface. Line input: 2-2.4 V(p-p), output impedance: 1 KΩ ± 10%	1-ch 3.5mm Mic in/Line in interface. Line input: 2-2.4 V(p-p), output impedance: 1 KΩ ± 10%
Audio Output	Line level, impedance: 600 Ω	Line level, impedance: 600 Ω	Linear Level; Impedance: 600 Ω	Line level, impedance: 600 Ω	Line level, impedance: 600 Ω
Alarm Input	2-ch input (0-5 VDC)	2-ch input (0-5 VDC)	2-ch inputs (0-5 VDC)	2-ch input (0-5 VDC)	2-ch input (0-5 VDC)
Alarm Output	2-ch relay output, supports Alarm Linkage	2-ch relay output, supports Alarm Linkage	2-ch relay output, supports Alarm Linkage	2-ch relay output, supports Alarm Linkage	2-ch relay output, supports Alarm Linkage
Power	12 VDC ± 20% PoE (802.3af) 24 VAC ± 25%	12 VDC ± 20% PoE (802.3af) 24 VAC ± 25%	100-240 VAC, max.15 W PoE (802.3at)	12 VDC ± 20% PoE (802.3af) 24 VAC ± 25%	12 VDC ± 20% PoE (802.3af) 24 VAC ± 25%
Environmental Requirement	From -40 °C to 65 °C (-40 °F to 149 °F); Humidity: 90% or less	From -40 °C to 60 °C (-40 °F to 149 °F); Humidity: 90% or less	From -40 °C to 65 °C (-40 °F to 149 °F); Humidity: 90% or less	From -40 °C to 65 °C (-40 °F to 149 °F); Humidity: 90% or less	From -40 °C to 65 °C (-40 °F to 149 °F); Humidity: 90% or less
VCA	Line Crossing, Intrusion, Region Entrance, Region Exiting	Line Crossing, Intrusion, Region Entrance, Region Exiting	Line Crossing, Intrusion, Region Entrance, Region Exiting	Line Crossing, Intrusion, Region Entrance, Region Exiting	Line Crossing, Intrusion, Region Entrance, Region Exiting
Fire Detection	Dynamic fire detection, up to 10 fire points detectable.	Dynamic fire detection, up to 10 fire points detectable.	Dynamic fire detection, up to 10 fire points detectable.	Dynamic fire detection, up to 10 fire points detectable.	Dynamic fire detection, up to 10 fire points detectable.
Temperature Mesuring Range	-20° C to 550° C (-4 °F to +1022°F)"	-20° C to 550° C (-4 °F to +1022°F)"	-20° C to 550° C (-4 °F to +1022°F)	-20° C to 550° C (-4 °F to +1022°F)"	-20° C to 550° C (-4 °F to +1022°F)"
Temperature Accuracy	Max (±2°C, ±2%)	Max (±2°C, ±2%)	Max (±2°C, ±2%)	Max (±2°C, ±2%)	Max (±2°C, ±2%)

Model	DS-2TD4237T-10/V2	DS-2TD4137T-9W/25W/50W	DS-2TD4167T-9W/25W	DS-2TD6267T-25H4LW/50H4LW	DS-2TD6566T-25H2LXV2/50H2LXV2
Image					
Thermal Camera Sensor	Vanadium Oxide Uncooled Focal Plane Arrays	Vanadium Oxide Uncooled Focal Plane Arrays	Vanadium Oxide Uncooled Focal Plane Arrays	Vanadium Oxide Uncooled Focal Plane Arrays	Vanadium Oxide Uncooled Focal Plane Arrays
NETD	< 40 mk (@25°C, F# = 1.0)	< 35 mk (@25°C, F# = 1.1)	< 35 mk (@25°C, F# = 1.1)	< 35 mk (@25°C, F# = 1.1)	< 40 mk (@25°C, F# = 1.0)
Pixel Pitch (Thermal)	17 μm	17 μm	17 μm	17 μm	17 μm
Max. Resolution (Thermal)	384 × 288	384 × 288	384 × 288	17 μm	640 × 512
Thermal Lens	Thermal: 10 mm Optical: 4.8-153 mm	Thermal: 9 or 25 mm Optical: 6-240 mm	Thermal: 9 or 25 mm Optical: 6-240 mm	Thermal: 9 or 25 mm Optical: 6-240 mm	Thermal: 25 or 50 mm Optical: 5.7-207mm
Optical Camera Sensor	1/2.8" Progressive Scan CMOS	1/1.8" Progressive Scan CMOS	1/1.8" Progressive Scan CMOS	1/1.8" Progressive Scan CMOS	1/1.9" Progressive Scan CMOS
Max. Resolution (Optical)	1920 × 1080	2688 × 1520	2688 × 1520	2688 × 1520	1920 × 1080
Min. Illumination	Color: 0.05 lux @ (F1.2, AGC On) B/W: 0.01 lux @ (F1.2, AGC On)	*Color: 0.005 Lux @ (F1.3, AGC ON) B/W: 0.001 Lux @ (F1.3, AGC ON)*	Color: 0.005 Lux @ (F1.3, AGC ON) B/W: 0.001 Lux @ (F1.3, AGC ON)	Color: 0.005 Lux @ (F1.3, AGC ON) B/W: 0.001 Lux @ (F1.3, AGC ON)	Color: 0.002 lux @ (F1.5 , AGC On) B/W : 0.0002 lux @ (F1.5 , AGC On)
Field of View (Thermal)	10 mm: 37.7° × 28.7°	9 mm: 37.9° × 28.7° 25 mm: 14.9° × 11.2° 50 mm: 7.5° × 5.6°	9 mm: 37.9° × 28.7° 25 mm: 14.9° × 11.2° 50 mm: 7.5° × 5.6°	25 mm: 24.55° × 19.75° 50 mm: 12.42° × 9.95°	25 mm: 24.55° × 19.75° 50 mm: 12.42° × 9.95°
Video Compression	H.265/H.264/MJPEG	H.265/H.264/MJPEG	H.265/H.264/MJPEG	H.265/H.264/MJPEG	H.265/H.264/MJPEG
Frame Rate	25 fps	25 fps	25 fps	25 fps	50 fps
Ingress Protection	IP66	IP66	IP66	IP66	IP68
Pan/Tilt	Pan: 360° Continuous Rotate; Tilt: From -5° to + 90° (auto flip)	Pan: 360° Continuous Rotate; Tilt: From -15° to + 90° (auto flip)	Pan: 360° Continuous Rotate; Tilt: From -15° to + 90° (auto flip)	Pan: 360° Continuous Rotate; Tilt: From -15° to + 90° (auto flip)	Pan: 360° Continuous Rotate; Tilt: From -90° to + 90° (auto flip)
Audio Input	1-ch 3.5mm Mic in/Line in interface. Line input: 2-2.4V(p-p), output impedance: 1 KΩ ± 10%	1-ch 3.5mm Mic in/Line in interface. Line input: 2-2.4V(p-p), output impedance: 1 KΩ ± 10%	1-ch 3.5mm Mic in/Line in interface. Line input: 2-2.4V(p-p), output impedance: 1 KΩ ± 10%	1-ch 3.5mm Mic in/Line in interface. Line input: 2-2.4V(p-p), output impedance: 1 KΩ ± 10%	LINE_IN Input/MIC Input; Peak: From 2 to 2.4 V(p-p); Output Impedance: 1 KΩ±10%
Audio Output	Linear Level; Impedance: 600 Ω	Linear Level; Impedance: 600 Ω	Linear Level; Impedance: 600 Ω	Linear Level; Impedance: 600 Ω	Linear Level; Impedance: 600 Ω
Alarm Input	Up to 7-ch input (0-5 VDC)	Up to 7-ch input (0-5 VDC)	Up to 7-ch input (0-5 VDC)	Up to 7-ch input (0-5 VDC)	Up to 7-ch Relay Input (0-5 VDC)
Alarm Output	2-ch relay outputs, alarm response actions configurable	2-ch relay outputs, alarm response actions configurable	2-ch relay outputs, alarm response actions configurable	2-ch relay outputs, alarm response actions configurable	Up to 2-ch; Support Alarm Linkage
Power	24 VAC	24 VAC	24 VAC	24 VAC	100-240 VAC
Environmental Requirement	From -40 °C to 65 °C (-40 °F to 149 °F); Humidity: 90% or less	From -40 °C to 65 °C (-40 °F to 149 °F); Humidity: 95% or less	From -40 °C to 65 °C (-40 °F to 149 °F); Humidity: 95% or less	From -40 °C to 65 °C (-40 °F to 149 °F); Humidity: 95% or less	-40 °C to 60 °C (-40 °F to 140 °F) 95% or less
VCA	Line Crossing, Intrusion, Region Entrance, Region Exiting	Line Crossing, Intrusion, Region Entrance, Region Exiting	Line Crossing, Intrusion, Region Entrance, Region Exiting	Line Crossing, Intrusion, Region Entrance, Region Exiting	Line Crossing, Intrusion, Region Entrance, Region Exiting
Fire Detection	Dynamic fire detection, up to 10 fire points detectable.	Dynamic fire detection, up to 10 fire points detectable.	Dynamic fire detection, up to 10 fire points detectable.	Dynamic fire detection, up to 10 fire points detectable.	Dynamic fire detection, up to 10 fire points detectable.
Temperature Measuring Range	-20° C to 550° C (-4 °F to +1022°F)	-20° C to 550° C (-4 °F to +1022°F)	-20° C to 550° C (-4 °F to +1022°F)	-20° C to 550° C (-4 °F to +1022°F)	-20° C to 550° C (-4 °F to +1022°F)
Temperature Accuracy	Max (±2°C, ±2%)	Max (±2°C, ±2%)	Max (±2°C, ±2%)	Max (±2°C, ±2%)	Max (±2°C, ±2%)

Model	DS-2TD2037T-4X/7X/10X	DS-2TD2067T-6/X	DS-2TA03-15SVI	DS-2TA06-25SVI	DS-2TD3017T-2V/3V
Image	 NEW	 NEW			 HOT
Thermal Camera Sensor	Vanadium Oxide Uncooled Focal Plane Arrays	Vanadium Oxide Uncooled Focal Plane Arrays	Vanadium Oxide Uncooled Focal Plane Arrays	Vanadium Oxide Uncooled Focal Plane Arrays	Vanadium Oxide Uncooled Focal Plane Arrays
NETD	<35 mK (@25°C, F# = 1.0)	<35 mK (@25°C, F# = 1.0)	< 40 mK (@25°C, F# = 1.0)	< 40 mK (@25°C, F# = 1.0)	< 40 mK (@25 °C, F# = 1.1)
Pixel Pitch (Thermal)	17 μm	17 μm	17 μm	17 μm	17 μm
Max. Resolution (Thermal)	384 × 288	640 × 512	384 × 288	640 × 512	160 × 120
Thermal Lens	4.5, 6.5 or 9.7 mm	6.3 mm	15 mm	25 mm	2 or 3 mm
Optical Camera Sensor	/	/	/	/	1600 × 1200
Max. Resolution (Optical)	/	/	/	/	Color: 0.04 Lux @ (2.4 AGC ON)
Min. Illumination	/	/	/	/	Thermal: 1.8 or 3.1 mm Optical: 1.29 mm
Field of View (Thermal)	4 mm: 90° × 65.2° 7 mm: 60° × 44.1° 10 mm: 37.5° × 28.5°	6 mm: 88.5° × 73.2°	39.87° × 32.36°	25° × 19°	2mm: 90° × 66.4° 3mm: 50° × 37.2°
Video Compression	H.264/MJPEG	H.264/MJPEG	H.265/H.264	H.265/H.264	H.265/H.264/MJPEG
Frame Rate	50 fps	50 fps	50 fps	50 fps	25 fps
Ingress Protection	IP40	IP40	IP40	IP40	IP66
Pan/Tilt	/	/	/	/	/
Audio Input	/	/	1-ch 3.5mm Mic in/Line in interface. Line input: 2-2.4V(p-p), output impedance: 1 KΩ ± 10%	1-ch 3.5mm Mic in/Line in interface. Line input: 2-2.4V(p-p), output impedance: 1 KΩ ± 10%	/
Audio Output	/	/	Linear Level; Impedance: 600 Ω	Linear Level; Impedance: 600 Ω	/
Alarm Input	1-ch input (0-3.3 VDC)	1-ch input (0-3.3 VDC)	1 in	1 in	1-ch inputs (0-5 VDC)
Alarm Output	1-ch output	1-ch output	1 out	1 out	1-ch relay outputs, alarm response actions configurable
Power	10-30 VDC, 2W	10-30 VDC, 2W	12 VDC	12 VDC	10-30 VDC, Max. 5W PoE (802.3af)
Environmental Requirement	From -20 °C to 50 °C (-40 °F to 149 °F); Humidity: 90% or less	From -20 °C to 50 °C (-40 °F to 149 °F); Humidity: 90% or less	From -20°C to 50°C (-4°F to 122°F); Humidity: 90% or less	From -20°C to 50°C (-4°F to 122°F); Humidity: 90% or less	From -20 °C to 50 °C (-40 °F to 149 °F); Humidity: 90% or less
VCA	/	/	/	/	/
Fire Detection	/	/	/	/	/
Temperature Mesuring Range	-20° C to 550° C (-4 °F to +1022°F)	-20° C to 550° C (-4 °F to +1022°F)	-20° C to 550° C (-4 °F to +1022°F)	-20° C to 550° C (-4 °F to +1022°F)	-20° C to 550° C (-4 °F to +1022°F)
Temperature Accuracy	Max (± 2 °C, ± 2%)	Max (± 2 °C, ± 2%)	Max (±2°C, ±2%)	Max (±2°C, ±2%)	Max (± 2 °C, ± 2%)



Temperature Screening Products

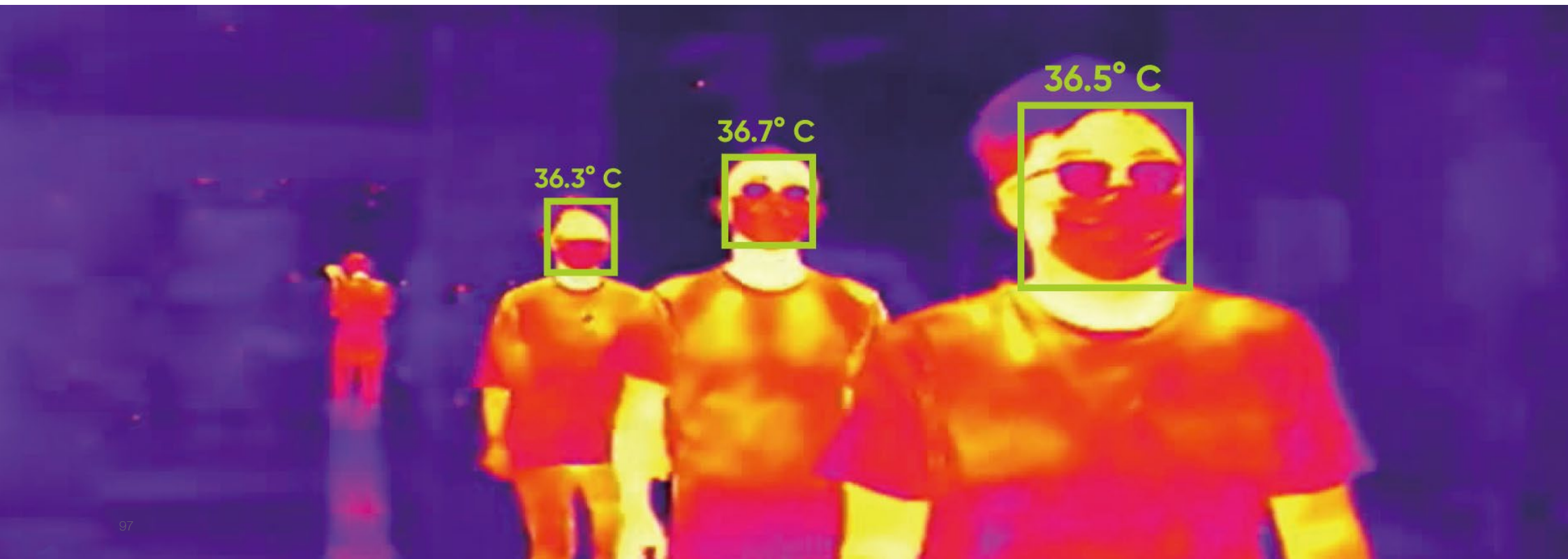

Safer & Smarter, Towards the New Normal

Hikvision's Temperature Screening Thermographic Cameras, with advanced algorithm and thermal detectors, are designed to detect elevated skin-surface temperatures. With accuracy up to ± 0.3 °C, they can be used for rapid and preliminary temperature screening in office buildings, factories, stations, airports, and other public places.

- > Safe - Noncontact measurement prevents physical contact
- > Fast - One second per capita for skin-surface temperature detection
- > Smart - Deep Learning detection reduces false alarms
- > Flexible - Multiple product choices for fixed or portable deployment
- > Accurate - Up to ± 0.5 °C (± 0.9 °F) w/o Blackbody Calibrator and ± 0.3 °C (± 0.5 °F) w/ Blackbody Calibrator



Model	DS-2TD1217B-3PA/6PA	DS-2TD2617B-3PA/6PA	DS-2TD263B-10P/13P/15P	DS-2TB3217-3W/6W NEW
Image	 Audio Warning and Strobe Light	 Audio Warning and Strobe Light		
Thermal Camera Sensor	Vanadium Oxide Uncooled Focal Plane Arrays	Vanadium Oxide Uncooled Focal Plane Arrays	Vanadium Oxide Uncooled Focal Plane Arrays	Vanadium Oxide Uncooled Focal Plane Arrays
NETD	< 40 mK (25°C), F# = 1.1	< 40 mK (25°C), F# = 1.1	< 40 mK (25°C), F# = 1.1	< 40 mK (@ 25 °C, F# = 1.0)
Pixel Pitch (Thermal)	17 μm	17 μm	17 μm	17 μm
Max. Resolution (Thermal)	160 × 120 (the resolution of output image is 320 × 240)	160 × 120 (the resolution of output image is 320 × 240)	384 × 288	160 × 120
Thermal Lens	3.1 or 6.2 mm	3.1 or 6.2 mm	10, 13 or 15 mm	3.1 or 6.2 mm
Optical Camera Sensor	1/2.7" Progressive Scan CMOS	1/2.7" Progressive Scan CMOS	1/2.7" Progressive Scan CMOS	1/2.7" Progressive Scan CMOS
Max. Resolution (Optical)	2688 × 1520	2688 × 1520	2688 × 1520	2688 × 1520
Min. Illumination	Color: 0.0089 Lux @ (F1.6, AGC ON), B/W: 0.0018 Lux @ (F1.6, AGC ON)	Color: 0.0089 Lux @ (F1.6, AGC ON), B/W: 0.0018 Lux @ (F1.6, AGC ON)	Color: 0.0089 Lux @ (F1.6, AGC ON), B/W: 0.0018 Lux @ (F1.6, AGC ON)	Color: 0.0089 Lux @ (F1.6, AGC ON), B/W: 0.0018 Lux @ (F1.6, AGC ON)
Field of View (Thermal)	3mm: 84° × 44.8° 6 mm: 39.42° × 22.14°	3mm: 84° × 44.8° 6 mm: 39.42° × 22.14°	10mm: 37.5° × 28.5° 13mm: 28.8° × 21.6° 15mm: 24.5° × 18.5°	3mm: 50° × 37.2° 6mm: 25° × 18.7°
Video Compression	H.265/H.264/MJPEG	H.265/H.264/MJPEG	H.265/H.264/MJPEG	H.265/H.264/MJPEG
Frame Rate	25fps	25fps	25fps	25fps
Battery Operating Time	/	/	/	/
Ingress Protection	IP66	IP66	IP66	IP67
Audio Input	1, 3.5 mm Mic in/Line in interface. Line input: 2 - 2.4 V [p-p], output impedance: 1 KΩ ±10%	1, 3.5 mm Mic in/Line in interface. Line input: 2 - 2.4 V [p-p], output impedance: 1 KΩ ±10%	1, 3.5 mm Mic in/Line in interface. Line input: 2 - 2.4 V [p-p], output impedance: 1 KΩ ±10%	1, 3.5 mm Mic in/Line in interface. Line input: 2 - 2.4 V [p-p], output impedance: 1 KΩ ±10%
Audio Output	Linear level; impedance: 600 Ω	Linear level; impedance: 600 Ω	Linear level; impedance: 600 Ω	Linear level; impedance: 600 Ω
Alarm Input	1-ch inputs (0-5 VDC)	2-ch inputs (0-5 VDC)	2-ch inputs (0-5 VDC)	2-ch inputs (0-5 VDC)
Alarm Output	1-ch relay outputs, alarm response actions configurable	2-ch relay outputs, alarm response actions configurable	2-ch relay outputs, alarm response actions configurable	2-ch relay outputs, alarm response actions configurable
Power	12 VDC ± 20% PoE (802.3af, class 3)	12 VDC ± 20% PoE (802.3af, class 3)	12 VDC ± 20% PoE (802.3af, class 3)	12 VDC ± 20% PoE (802.3af, class 3)
Environmental Requirement	10 °C to 35 °C (Indoor and windless environment use only) 95% or less	Temperature: 10 °C to 35 °C (Indoor and windless environment use only) Humidity: 95% or less	Temperature: 10 °C to 35 °C (Indoor and windless environment use only) Humidity: 95% or less	Temperature: 10 °C to 35 °C (Indoor and windless environment use only) Humidity: 95% or less
Temperature Mesuring Range	30 °C to +45 °C	30 °C to +45 °C	30 °C to +45 °C	28 °C to 45 °C
Temperature Accuracy	± 0.5°C	± 0.5°C	± 0.5°C	± 0.5°C

Model	DS-2TP31B-3AUF	DS-2TP21B-6AVF/W
Image		
Thermal Camera Sensor	Vanadium Oxide Uncooled Focal Plane Arrays	Vanadium Oxide Uncooled Focal Plane Arrays
Pixel Pitch(Thermal)	17 μm	17 μm
Sensitivity	< 40 mk (@ 25 °C,F#=1.0)	< 40 mk (@ 25 °C,F#=1.0)
IFOV	5.48 mrad	2.74 mrad
Max. Resolution	Thermal: 160 x 120	160 x 120
Frame rate	25 fps	25 fps
Thermal Lens	3.1 mm	6.2 mm (Manual focus)
Field of View (Thermal)	37.2° × 50 °	25° × 18.7°
Monitor	320 × 240 resolution 2.4" LCD display	640 × 480 resolution 3.5" LCD touch display
Storage	Replaceable memory card (default 8G, support up to 128G storage)	Built-in memory module (16 G)
Wi-Fi	/	support
Battery Operating Time	8 hours continuous running	"5 hours in normal temperature, with Wi-Fi, Bluetooth, and supplement light off. 4 hours in normal temperature, with Wi-Fi, Bluetooth, and supplement light on."
Ingress Protection	IP54	IP54
Fall Resistant Level	2 m (6.56 feet)	2 m (6.56 feet)
Operating Temperature	-10 °C to 50 °C (14 °F to 122 °F)	15°C to 35 °C
Temperature Measuring Range	30°C to 45 °C	30°C to 45 °C
Temperature Accuracy	±0.5 °C	±0.5 °C
Dimension	196 mm × 117 mm × 59 mm (7.7 " × 4.6 " × 2.3 ")	244 mm × 100 mm × 104 mm (9.6 " × 3.9 " × 4.1 ")
Weight	Approx. less than 350 g (0.77 lb)	"With Battery: 653 g (1.44 lb) Without Battery: 511 g (1.13 lb)"
Temperature Accuracy	Max (± 2 °C, ± 2%)	Max (± 2 °C, ± 2%)

Commercial Display

- 101** LCD Video Wall
- 104** LED Display
- 110** Interactive Display
- 111** Digital Signage











LCD Video Wall

See It Better

- > Ultra-narrow bezel widths: 0.88, 1.8, and 3.5 mm
- > Industrial-grade panel and structure design
- > Precise in-factory color calibration
- > Various modes for multiple scenarios
- > Advanced UHD (4K) Splicing
- > Anti-static/Radiation protection



Model		DS-D2046LU-Y	DS-D2049LU-Y	DS-D2055LU-Y	DS-D2055HU-Y
Image		NEW	NEW	NEW	NEW
					
Display	Diagonal Size (inch)	46"	49"	55"	55"
	Backlight	LED Backlight (Direct type)	LED Backlight (Direct type)	LED Backlight (Direct type)	LED Backlight (Direct type)
	Panel	IPS	IPS	IPS	IPS
	Resolution	1920 x 1080	1920 x 1080	1920 x 1080	1920 x 1080
	Color	16.7M	16.7M	16.7M	16.7M
	Visual Angle	Horizontal: 178°, Vertical: 178°	Horizontal: 178°, Vertical: 178°	Horizontal: 178°, Vertical: 178°	Horizontal: 178°, Vertical: 178°
	Response Time	8 ms (G to G)	8 ms (G to G)	8 ms (G to G)	8 ms (G to G)
	Contrast	1200:1	1200:1	1200:1	1200:1
	Brightness	500 cd/m ²	700 cd/m ²	500 cd/m ²	700 cd/m ²
	Dot Pitch (H×V)	0.53 mm × 0.53 mm (0.021" × 0.021")	0.56 mm × 0.56 mm (0.022" × 0.022")	0.63 mm × 0.63 mm (0.025" × 0.025")	0.63 mm × 0.63 mm (0.025" × 0.025")
	Color Saturation	72%	72%	72%	72%
Screen Moving Area (H×V)	1018.08 mm × 572.67 mm (40.08" × 22.55")	1074.24 mm × 604.26 mm (42.29" × 23.78")	1209.63 mm × 680.34 mm (47.62" × 26.78")	1209.63 mm × 680.34 mm (47.62" × 26.78")	
Side Frame Size	Physical Seam	3.5 mm (0.14")	3.5 mm (0.14")	3.5 mm (0.14")	3.5 mm (0.14")
Interface	Input Interface	VGA × 1, HDMI × 1, DVI × 1, DP × 1, USB × 1	VGA × 1, HDMI × 1, DVI × 1, DP × 1, USB × 1	VGA × 1, HDMI × 1, DVI × 1, DP × 1, USB × 1	VGA × 1, HDMI × 1, DVI × 1, DP × 1, USB × 1
	Output Interface	DP × 1, HDMI × 1	DP × 1, HDMI × 1	DP × 1, HDMI × 1	DP × 1, HDMI × 1
	Control Interface	RS232 IN × 1, RS232 OUT × 1	RS232 IN × 1, RS232 OUT × 1	RS232 IN × 1, RS232 OUT × 1	RS232 IN × 1, RS232 OUT × 1
Power	Power Consumption	111 W	134 W	187 W	235 W
	Power Requirement	100 to 240 VAC, 50 or 60 Hz	100 to 240 VAC, 50 or 60 Hz	100 to 240 VAC, 50 or 60 Hz	100 to 240 VAC, 50 or 60 Hz
Working Environment	Operating Temperature	0 °C to 40 °C (32 °F to 104 °F)	0 °C to 40 °C (32 °F to 104 °F)	0 °C to 40 °C (32 °F to 104 °F)	0 °C to 40 °C (32 °F to 104 °F)
	Operating Humidity	10% to 80% (No Condensation)	10% to 80% (No Condensation)	10% to 80% (No Condensation)	10% to 80% (No Condensation)
	Working Life	≥ 60,000 Hours	≥ 60,000 Hours	≥ 60,000 Hours	≥ 60,000 Hours
Physical Features	Dimension (W×H×D)	1021.98 mm × 576.57 mm × 72.25 mm (40.24" × 22.7" × 2.84")	1078.34 mm × 608.36 mm × 72.8 mm (42.45" × 23.95" × 2.87")	1213.5 mm × 684.3 mm × 71.74 mm (47.78" × 26.94" × 2.82")	1213.5 mm × 684.3 mm × 71.74 mm (47.78" × 26.94" × 2.82")
	Frame Width	2.3 mm (top/left) 1.2 mm (bottom/right)	2.3 mm (top/left) 1.2 mm (bottom/right)	2.3 mm (top/left) 1.2 mm (bottom/right)	2.3 mm (top/left) 1.2 mm (bottom/right)
	Bracket	-	-	-	-

Model		DS-D2055LE-G	DS-D2055HE-G	DS-D2055LR-G	DS-D2055HR-G
Image		 NEW	 NEW	 NEW	 NEW
	Diagonal Size (inch)	55"	55"	55"	55"
Display	Backlight	LED Backlight (Direct type)	LED Backlight (Direct type)	LED Backlight (Direct type)	LED Backlight (Direct type)
	Panel	IPS	IPS	IPS	IPS
	Resolution	1920 x 1080	1920 x 1080	1920 x 1080	1920 x 1080
	Color	1.07 Billion	1.07 Billion	1.07 Billion	1.07 Billion
	Visual Angle	Horizontal: 178°, Vertical: 178°	Horizontal: 178°, Vertical: 178°	Horizontal: 178°, Vertical: 178°	Horizontal: 178°, Vertical: 178°
	Response Time	8 ms (G to G)	8 ms (G to G)	8 ms (G to G)	8 ms (G to G)
	Contrast	1400:1	1400:1	1200:1	1100:1
	Brightness	500 cd/m ²	700 cd/m ²	500 cd/m ²	700 cd/m ²
	Dot Pitch (H×V)	0.63 mm × 0.63 mm (0.025" × 0.025")	0.63 mm × 0.63 mm (0.025" × 0.025")	0.63 mm × 0.63 mm (0.025" × 0.025")	0.63 mm × 0.63 mm (0.025" × 0.025")
	Color Saturation	72%	72%	72%	72%
	Screen Moving Area (H×V)	1209.6 mm × 680.3 mm (47.62" × 26.78")	1209.6 mm × 680.3 mm (47.62" × 26.78")	1209.63 mm × 680.34 mm (47.62" × 26.78")	1209.63 mm × 680.34 mm (47.62" × 26.78")
	Side Frame Size	Physical Seam	1.8 mm (0.07")	1.8 mm (0.07")	0.88 mm (0.034")
Interface	Input Interface	VGA × 1, HDMI × 1, DVI × 1, DP × 1, USB × 1	VGA × 1, HDMI × 1, DVI × 1, DP × 1, USB × 1	VGA × 1, HDMI × 1, DVI × 1, DP × 1, USB × 1	VGA × 1, HDMI × 1, DVI × 1, DP × 1, USB × 1
	Output Interface	DP × 1, HDMI × 1	DP × 1, HDMI × 1	DP × 1, HDMI × 1	DP × 1, HDMI × 1
	Control Interface	RS232 IN × 1, RS232 OUT × 1	RS232 IN × 1, RS232 OUT × 1	RS232 IN × 1, RS232 OUT × 1	RS232 IN × 1, RS232 OUT × 1
Power	Power Consumption	192 W	230 W	192 W	230 W
	Power Requirement	100 to 240 VAC, 50 or 60 Hz	100 to 240 VAC, 50 or 60 Hz	100 to 240 VAC, 50 or 60 Hz	100 to 240 VAC, 50 or 60 Hz
Working Environment	Operating Temperature	0 °C to 40 °C (32 °F to 104 °F)	0 °C to 40 °C (32 °F to 104 °F)	0 °C to 40 °C (32 °F to 104 °F)	0 °C to 40 °C (32 °F to 104 °F)
	Operating Humidity	10% to 90% (No Condensation)	10% to 90% (No Condensation)	10% to 90% (No Condensation)	10% to 90% (No Condensation)
	Working Life	≥ 60,000 Hours	≥ 60,000 Hours	≥ 60,000 Hours	≥ 60,000 Hours
Physical Features	Dimension (W×H×D)	1211.54 mm × 682.34 mm × 68.9 mm (47.7" × 26.86" × 2.71")	1211.54 mm × 682.34 mm × 68.9 mm (47.7" × 26.86" × 2.71")	1210.81 mm × 681.76 mm × 68.9 mm (47.67" × 26.84" × 2.71")	1210.81 mm × 681.76 mm × 68.9 mm (47.67" × 26.84" × 2.71")
	Frame Width	0.9 mm (top/left) 0.9 mm (bottom/right)	0.9 mm (top/left) 0.9 mm (bottom/right)	0.44 mm (top/left) 0.44 mm (bottom/right)	0.44 mm (top/left) 0.44 mm (bottom/right)
	Bracket	-	-	-	-





LED Display





Brighten Every Moment





- › Pix Master Pixel Control – Proprietary image processing technology enhances image clarity without loss of detail.
- › Top Grey Level – 22-bit top grey level brings you a wider range of color grades
- › Remote Control – Remote controller meets all your needs, including display modes adjustments & signal source switches, brightness level, automatic dehumidification and blue light filtering
- › User-friendly Design – Flexible installation with floor-standing, wall-mounting, and hoisting methods to choose from; easier maintenance with front magnetic wireless module design
- › Automatic Dehumidification – Automatic dehumidification function lowers light failures by 30% on average, effectively lengthening lifespan









Indoor LED Display

Model		DS-D4209FI-MWF / III	DS-D4212FI-GWF/III	DS-D4212FI-CWF/III	DS-D4212FI-MWF	DS-D4215FI-GWF/III
Image		 NEW			 NEW	
Module Composition	Pixel structure	Surface mounted quaternary LED	SMD Triad LED	SMD Triad LED	SMD Triad LED	SMD Triad LED
	Pixel pitch (mm)	0.9375 mm	1.25 mm	1.25 mm	1.25 mm	1.5625 mm
	Module Resolution (W × H)	320 × 90	240 × 67	240 × 67	240 × 67	192 × 54
	Module Dimension (W × H)	300 mm × 84.375 mm	300 mm × 83.75 mm	300 mm × 83.75 mm	300 mm × 83.75 mm	300 mm × 84.375 mm
	Unit module composition (W × H)	2 × 4	2 × 4	2 × 4	2 × 4	2 × 4
Unit Composition	Unit Resolution (W × H)	640 × 360	480 × 270	480 × 270	480 × 270	384 × 216
	Unit area	0.2025 m ²	0.2025 m ²	0.2025 m ²	0.2 m ²	0.2025 m ²
	Weight	5.4 Kg (11.9 lb)	5.4 Kg (11.9 lb)	5.4 Kg (11.9 lb)	5.4 Kg (11.9 lb)	5.4 Kg (11.9 lb)
	Pixel density	142222 dots/m ²	640000 dots/m ²	640000 dots/m ²	640000 dots/m ²	409600 dots/m ²
	Unit Ratio	0.2025 m ²	0.2025 m ²	0.2025 m ²	16:9	16:9
Optical Parameters	Brightness(nits)	800	800	800	800	800
	Color Temperature	3000 to 10000 adjustable	3000 to 10000 adjustable	3000 to 10000 adjustable	3000 to 10000 adjustable	3000 to 10000 adjustable
	Viewing Angle	Horizontal 160°, vertical 160°	Horizontal 160°, vertical 160°	Horizontal 160°, vertical 160°	Horizontal 160°, vertical 160°	Horizontal 160°, vertical 160°
	Luminous point center distance deviation	< 3%	< 3%	< 3%	< 3%	< 3%
	Brightness uniformity	≥ 97%	≥ 97%	≥ 97%	≥ 97%	≥ 97%
	Color uniformity	≤ ± 0.003Cx, Cy	≤ ± 0.003Cx, Cy	≤ ± 0.003Cx, Cy	≤ ± 0.003Cx, Cy	≤ ± 0.003Cx, Cy
	Max. Contrast	≥ 5000:1	≥ 5000:1	≥ 5000:1	≥ 5000:1	≥ 5000:1
Electrical parameters	Peak Consumption	142	600	600	600	450
	Average Consumption	47	200	200	200	150
	Power Supply	110 to 240 VAC ± 15%	110 to 240 VAC ± 15%	110 to 240 VAC ± 15%	110 to 240 VAC ± 15%	110 to 240 VAC ± 15%
Processing Performance	Drive Mode	Constant current driving	Constant current driving	Constant current driving	Constant current driving	Constant current driving
	Frame Rate	Constant current driving	60 Hz	60 Hz	60 Hz	60 Hz
	Refresh Rate	Up to 3840 Hz	Up to 3840 Hz	Up to 3840 Hz	Up to 3840 Hz	Up to 3840 Hz
General	Service life(H)	≥ 100,000 h	≥ 100,000 h	≥ 100,000 h	≥ 100,000 h	≥ 100,000 h
	Temperature(°C)	-10°C to 40°C	-10°C to 40°C	-10°C to 40°C	-10°C to 40°C	-10°C to 40°C
	Humidity(RH)	10% to 80% RH (non-condensing)	10% to 80% RH (non-condensing)	10% to 80% RH (non-condensing)	10% to 60% RH (non-condensing)	10% to 80% RH (non-condensing)

Model		DS-D4215FI-CWF/ III	DS-D4215FI-MWF	DS-D4218FI-CWF/ III	DS-D4225FI-CWF/ III	DS-D4237FI-CWF/ III
Image						
Module Composition	Pixel structure	SMD Triad LED	SMD Quaternary LED	SMD Triad LED	SMD Triad LED	SMD Triad LED
	Pixel pitch (mm)	1.5625 mm	1.56 mm	1.875 mm	2.48 mm	3.75 mm
	Module Resolution (W × H)	192 × 54	192 × 54	160 × 45	120 × 34	80 × 45
	Module Dimension (W × H)	300 mm × 84.375 mm	300 mm × 84.375 mm	300 mm × 84.375 mm	300 mm × 84.32 mm	300 mm × 168.75 mm
	Unit module composition (W × H)	2 × 4	2 × 4	2 × 4	2 × 4	2 × 2
Unit Composition	Unit Resolution (W × H)	384 × 216	384 × 216	320 × 180	240 × 136	160 × 90
	Unit area	0.2025 m ²	0.2 m ²	0.2025 m ²	0.2025 m ²	0.2025 m ²
	Weight	5.4 Kg (11.9 lb)	5.4 Kg (11.9 lb)	5.4 Kg (11.9 lb)	5.4 Kg (11.9 lb)	5.4 Kg (11.9 lb)
	Pixel density	409600 dots/m ²	409600 dots/m ²	284444 dots/m ²	161185 dots/m ²	71111 dots/m ²
	Unit Ratio	16:9	16:9	16:9	16:9	16:9
Optical Parameters	Brightness(nits)	800	600	800	800	800
	Color Temperature	3000 to 10000 adjustable	3000 to 10000 adjustable	3000 to 10000 adjustable	3000 to 10000 adjustable	3000 to 10000 adjustable
	Viewing Angle	Horizontal 160°, vertical 160°	Horizontal 160°, vertical 160°	Horizontal 160°, vertical 160°	Horizontal 160°, vertical 160°	Horizontal 160°, vertical 160°
	Luminous point center distance deviation	< 3%	< 3%	< 3%	< 3%	< 3%
	Brightness uniformity	≥ 97%	≥ 97%	≥ 97%	≥ 97%	≥ 97%
	Color uniformity	≤ ± 0.003Cx, Cy	≤ ± 0.003Cx, Cy	≤ ± 0.003Cx, Cy	≤ ± 0.003Cx, Cy	≤ ± 0.003Cx, Cy
	Max. Contrast	≥ 5000:1	≥ 3000:1	≥ 5000:1	≥ 5000:1	≥ 5000:1
Electrical parameters	Peak Consumption	450	550	345	375	270
	Average Consumption	150	183	115	125	90
	Power Supply	110 to 240 VAC ± 15%	110 to 240 VAC ± 15%	110 to 240 VAC ± 15%	110 to 240 VAC ± 15%	110 to 240 VAC ± 15%
Processing Performance	Drive Mode	Constant current driving	Constant current driving	Constant current driving	Constant current driving	Constant current driving
	Frame Rate	60 Hz	60 Hz	60 Hz	60 Hz	60 Hz
	Refresh Rate	Up to 3840 Hz	Up to 3840 Hz	Up to 3840 Hz	Up to 3840 Hz	Up to 3840 Hz
General	Service life(H)	≥ 100,000 h	≥ 100,000 h	≥ 100,000 h	≥ 100,000 h	≥ 100,000 h
	Temperature(°C)	-10°C to 40°C	-10°C to 40°C	-10°C to 40°C	-10°C to 40°C	-10°C to 40°C
	Humidity(RH)	10% to 80% RH (non-condensing)	10% to 60% RH (non-condensing)	10% to 80% RH (non-condensing)	10% to 80% RH (non-condensing)	10% to 80% RH (non-condensing)

Model		DS-D4418FI-CAF(B)	DS-D4420FI-CAF	DS-D4425FI-CAF(B)	DS-D4430FI-CAF	DS-D4437FI-CAF
Image		 NEW		 NEW		
Module Composition	Pixel structure	SMD Triad LED	1R1G1B	SMD Triad LED	1R1G1B	1R1G1B
	Pixel pitch (mm)	1.875 mm	2.1 mm	2.5 mm	3.0 mm	3.75 mm
	Module Resolution (W × H)	128 × 144	112 × 128	96 × 108	80 × 90	64 × 72
	Module Dimension (W × H)	240 mm × 270 mm	240 mm × 270 mm	240 mm × 270 mm	240 mm × 270 mm	240 mm × 270 mm
Unit Composition	Unit module composition (W × H)	2 × 1, 2 × 2, 1 × 2	2 × 2	2 × 1, 2 × 2, 1 × 2	2 × 2	2 × 2
	Unit Resolution (W × H)	256 × 144, 256 × 288, 128 × 288	224 × 256	192 × 108, 192 × 216, 96 × 216	160 × 180	128 × 144
	Unit area	0.1296 m ² , 0.2592 m ² , 0.1296 m ²	0.2592 m ²	0.1296 m ² , 0.2592 m ² , 0.1296 m ²	0.2592 m ²	0.2592 m ²
	Weight	3.5 Kg (7.72lb)	≤7kg (15.4lb)	3.5 Kg (7.72lb), 6.9kg(15.21lb)	≤7kg (15.4lb)	≤7kg (15.4lb)
	Pixel density	284,444 dots/m ²	221,234 dots/m ²	160000 dots/m ²	111,111 dots/m ²	71,111 dots/m ²
	Unit Ratio	16:9	16:9	16:9	16:9	16:9
	Brightness(nits)	800	600	800	600	600
Optical Parameters	Color Temperature	3000 to 10000 adjustable	2000 to 10000 adjustable	3000 to 10000 adjustable	2000 to 10000 adjustable	2000 to 10000 adjustable
	Viewing Angle	Horizontal 160°, vertical 160°	Horizontal 160°, vertical 160°	Horizontal 160°, vertical 160°	Horizontal 160°, vertical 160°	Horizontal 160°, vertical 160°
	Luminous point center distance deviation	≤ 3%	≤ 3%	≤ 3%	≤ 3%	≤ 3%
	Brightness uniformity	≥ 97%	≥ 97%	≥ 97%	≥ 97%	≥ 97%
	Color uniformity	≤ ± 0.003 Cx, Cy	≤ ± 0.003 Cx, Cy	≤ ± 0.003 Cx, Cy	≤ ± 0.003 Cx, Cy	≤ ± 0.003 Cx, Cy
	Max. Contrast	≥5000 : 1	≥5000 : 1	≥5000 : 1	≥5000 : 1	≥5000 : 1
	Peak Consumption	600	700	600	700	700
Electrical parameters	Average Consumption	200	202	200	202	202
	Power Supply	110 to 240 VAC ± 15%	100 to 240 VAC ± 15%	110 to 240 VAC ± 15%	100 to 240 VAC ± 15%	100 to 240 VAC ± 15%
	Drive Mode	Constant current driving	Constant current driving	Constant current driving	Constant current driving	Constant current driving
Processing Performance	Frame Rate	60 Hz	60 Hz	60 Hz	60 Hz	60 Hz
	Refresh Rate	Up to 3840 Hz	1,920 Hz	3,840 Hz	1,920 Hz	1,920 Hz
	Service life(H)	≥ 100,000 h	≥ 100,000 h	≥ 100,000 h	≥ 100,000 h	≥ 100,000 h
General	Temperature(°C)	-10°C to 40°C	-10°C to 40°C	-10°C to 40°C	-10°C to 40°C	-10°C to 40°C
	Humidity(RH)	10 to 80 % (non-condensing)	10 to 95 % (non-condensing)	10 to 80 % (non-condensing)	10 to 95 % (non-condensing)	10 to 95 % (non-condensing)

Outdoor LED Display

Model	DS-D4240F0	DS-D4250F0	DS-D4260F0	DS-D4280F0	DS-D42A0F0	DS-D42A0F0-D	DS-D42A6F0-D	
Image								
Module Composition	Pixel structure	SMD Triad LED	SMD Triad LED	SMD Triad LED	SMD Triad LED	SMD Triad LED	DIP Triad LED	DIP Triad LED
	Pixel pitch (mm)	4.0 mm	5.0 mm	6.67 mm	8.0 mm	10 mm	10 mm	16 mm
	Module Resolution (W × H)	80 x 40	64 x 32	48 x 24	40 x 20	32 x 16	32 x 16	20 x 10
	Module Dimension (W × H)	320 mm x 160 mm	320 mm x 160 mm	320 mm x 160 mm	320 mm x 160 mm	320 mm x 160 mm	320 mm x 160 mm	320 mm x 160 mm
	Unit module composition (W × H)	3 x 6	3 x 6	3 x 6	3 x 6	3 x 6	3 x 6	3 x 6
Unit Composition	Unit Resolution (W × H)	240 x 240	192 x 192	144 x 144	120 x 120	96 x 96	96 x 96	60 x 60
	Unit area	0.9216 m ²	0.9216 m ²	0.9216 m ²	0.9216 m ²	0.9216 m ²	0.9216 m ²	0.9216 m ²
	Weight	29 Kg	29Kg	29Kg	29Kg	29Kg	29Kg	29Kg
	Pixel density	62500 dots/m ²	40000 dots/m ²	22500 dots/m ²	15625 dots/m ²	10000 dots/m ²	10000 dots/ m ²	3906 dots/m ²
	Unit Ratio	1:1	1:1	1:1	1:1	1:1	1:1	1:1
Optical Parameters	Brightness(nits)	≥5500(cd/m2)	≥5500(cd/m2)	≥6000(cd/m2)	≥6000(cd/m2)	≥6000(cd/m2)	≥7500(cd/m2)	≥7500(cd/m2)
	Color Temperature	2000-9300K adjustable	2000-9300K adjustable	2000-9300K adjustable	2000-9300K adjustable	2000-9300K adjustable	2000-9300K adjustable	2000-9300K adjustable
	Viewing Angle	140 (Horizontal), 140 (Vertical)	140 (Horizontal), 140 (Vertical)	140 (Horizontal), 140 (Vertical)	140 (Horizontal), 140 (Vertical)	140°(Horizontal),140°(Vertical)	110°(Horizontal),50°(Vertical)	110°(Horizontal),50°(Vertical)
	Luminous point center distance deviation	< 3%	< 3%	< 3%	< 3%	< 3%	< 3%	< 3%
	Brightness uniformity	≥95%	≥97%	≥97%	≥97%	≥97%	≥97%	≥97%
	Color uniformity	≤ ± 0.003 Cx, Cy	≤ ± 0.003 Cx, Cy	≤ ± 0.003 Cx, Cy	≤ ± 0.003 Cx, Cy	≤ ± 0.003 Cx, Cy	≤ ± 0.003 Cx, Cy	≤ ± 0.003 Cx, Cy
	Peak Consumption	850 W/m ²	850 W/m ²	850 W/m ²	780 W/m ²	780 W/m ²	500 W/m ²	500 W/m ²
Electrical parameters	Average Consumption	280 W/m ²	280 W/m ²	280 W/m ²	260 W/m ²	260 W/m ²	165 W/m ²	165 W/m ²
	Power Supply	110 to 240 VAC ± 15%	110 to 240 VAC ± 15%	110 to 240 VAC ± 15%	110 to 240 VAC ± 15%	110 to 240 VAC ± 15%	110 to 240 VAC ± 15%	110 to 240 VAC ± 15%
	Drive Mode	Constant Current Driving	Constant Current Driving	Constant Current Driving	Constant Current Driving	Constant Current Driving	Constant Current Driving	Constant Current Driving
Processing Performance	Frame Rate	60 Hz	60 Hz	60 Hz	60 Hz	60 Hz	60 Hz	60 Hz
	Refresh Rate	3840Hz	3840Hz	3840Hz	3840Hz	3840Hz	3840Hz	3840Hz
	Service life(H)	>100,000 (H)	>100,000 (H)	>100,000 (H)	>100,000 (H)	>100,000 (H)	>100,000 (H)	>100,000 (H)
General	Temperature(°C)	-10 to 55 ° C (14 to 131° F)	-10 to 55 ° C (14 to 131° F)	-10 to 55 ° C (14 to 131° F)	-10 to 55 ° C (14 to 131° F)	-10 to 55 ° C (14 to 131° F)	-10 to 55 ° C (14 to 131° F)	-10 to 55 ° C (14 to 131° F)
	Humidity(RH)	10-80%(Non-condensing)	10-90%(Non-condensing)	10-80%(Non-condensing)	10-80%(Non-condensing)	10-80%(Non-condensing)	10-80%(Non-condensing)	10-80%(Non-condensing)

Network Camera PTZ Dome Camera Panoramic Camera Explosion-Proof & Anti-Corrosion Series NVR Network Storage Data Center Thermal Display Decoder Video Wall Software Accessories DORI Distance

LED Controller

Model	DS-D42C04-H	DS-D42C08-H	DS-D42C16-H	DS-D42C04-N	DS-D42C06-N
Image		 NEW	 NEW	 NEW	 NEW
Video & Audio Input	1-ch DVI, 1-ch HDMI, 1-ch DP	2 × HDMI, 1 × DP, 1 × DVI	2 × HDMI, 1 × DP, 1 × DVI	1 × DVI, 1 × HDMI, 1 × Audio	1 × DVI, 2x HDMI, 2x3G-SDI, 1 x DVI+DVI LOOP, 2 x USB
Video & Audio Output	8ch ports output, 1ch DVI output	1 × HDMI	1 × HDMI	4 × RJ45	6 × RJ45, 1 × DVI
Network Interface	4	8	16	4	6
Control Interface	RJ45 × 1	RJ45 × 1	RJ45 × 1	USB × 1	USB × 2, RJ45 × 1
Max. Load Capacity	3840 × 1080@60Hz or 1920 × 2160@60Hz	5 MP	10 MP	2048 × 1152@60Hz or 1920 × 1200@60Hz	2560 × 1440@60hz
Frame Frequency	60 Hz	50/60 Hz	50/60 Hz	50/60 Hz	50/60 Hz
Refresh Rate	3840 Hz	3840 Hz	3840 HZ	3840 Hz	3840 Hz
Processing Depth	16 bit	8 bit	8 bit	8 bit	8 bit
Grey Level	65535 bits	16 bit	16 bit	16 bit	16 bit
Display Color	281.4 trillion	281 trillion	281 trillion	281 trillion	281 trillion
Brightness Control	Automatic/manual	1 to 10 levels adjustable (gradual white balance)	1 to 10 levels adjustable (gradual white balance)	Automatic/manual	Automatic/manual
Average Consumption	20 W	13.3 W	13.3 W	16 W	65 W
Input Voltage	100-240 VAC	100-240 VAC	100-240 VAC	AC100-240V@50/60HZ	AC100-240V@50/60HZ
Working Temperature	-10 to 45 °C (14 to 113 °F)	0 °C to 40 °C (32 °F to 104 °F)	0 °C to 40 °C (32 °F to 104 °F)	-10 °C to 45 °C (14 °F to 113 °F)	-10 °C to 45 °C (14 °F to 113 °F)
Working Humidity	10 to 90%	10% to 80%	10% to 80%	10% to 90%	10% to 90%
Storage Temperature	-20 to 60 °C (-4 to 140 °F)	-10 °C to 60 °C (14 °F to 140 °F)	-10 °C to 60 °C (14 °F to 140 °F)	-20 °C to 60 °C (-4 °F to 140 °F)	-20 °C to 60 °C (-4 °F to 140 °F)
Storage Humidity	10 to 90%	10% to 80%	10% to 80%	10% to 90%	10% to 90%
Product Dimensions (W × H × D)	482.6 × 250 × 44.5 mm (19 × 9.8 × 1.8 inch)	442 mm × 249.5 mm × 57 mm (17.40" × 9.82" × 2.24")	442 mm × 249.5 mm × 57 mm (17.40" × 9.82" × 2.24")	428 mm × 250 mm × 44.4 mm (16.85" × 9.84" × 1.75")	483.6 mm × 250.1 mm × 45 mm (19.04" × 9.85" × 1.77")

Interactive Display

Smarter Touch,
Smarter Communication

- > UHD 4K resolution
- > Anti-glare and anti-collision tempered glass protection
- > 20-Point touch control and smooth writing experience
- > On-screen annotations with built-in whiteboard software
- > Wireless projection
- > Built-in Android OS, OPS optional







Model	DS-D5A55RB/B	DS-D5A65RB/B	DS-D5A75RB/B	DS-D5A86RB/B	
Image					
Display	Diagonal Size	55"	65"	75"	86"
	Backlight	OLED Backlight	LED Backlight	LED Backlight	LED Backlight
	Panel	LCD	LCD	LCD	LCD
	Resolution	3840 × 2160 @ 60 Hz	3840 × 2160 @ 60 Hz	3840 × 2160 @ 60 Hz	3840 × 2160 @ 60 Hz
	Color	10 bit	10 bit	10 bit	10 bit
	Visual Angle	Horizontal 178°, vertical 178°	Horizontal 178°, vertical 178°	Horizontal 178°, vertical 178°	Horizontal 178°, vertical 178°
	Response Time	9 ms	6 ms	6 ms	6 ms
	Contrast	1200:1	1200:1	1200:1	1200:1
	Brightness	350 cd/m ²	450 cd/m ²	450 cd/m ²	400 cd/m ²
	Dot Pitch (H×V)	0.315(H) mm × 0.315(V) mm	0.372(H) mm × 0.372(V) mm	0.496(H) mm × 0.372(V) mm	0.4935(H) mm × 0.4935(V) mm
Interface	Screen Moving Area (H×V)	-	-	-	-
	Input Interface	HDMI IN × 2, VGA IN × 1, PC AUDIO IN × 1, LINE IN × 1	HDMI IN × 2, VGA IN × 1, PC AUDIO IN × 1, LINE IN × 1	HDMI IN × 2, VGA IN × 1, PC AUDIO IN × 1, LINE IN × 1	HDMI IN × 2, VGA IN × 1, PC AUDIO IN × 1, LINE IN × 1
Power	Output Interface	HDMI OUT × 1, LINE OUT × 1, SPDIF OUT × 1, Built-in 16 W speaker × 2	HDMI OUT × 1, LINE OUT × 1, SPDIF OUT × 1, Built-in 16 W speaker × 2	HDMI OUT × 1, LINE OUT × 1, SPDIF OUT × 1, Built-in 16 W speaker × 2	HDMI OUT × 1, LINE OUT × 1, SPDIF OUT × 1, Built-in 16 W speaker × 2
	Control Interface	RJ45 (100Mbps ports) × 2, RS-232 × 1	RJ45 (100Mbps ports) × 2, RS-232 × 1	RJ45 (100Mbps ports) × 2, RS-232 × 1	RJ45 (100Mbps ports) × 2, RS-232 × 1
Working Environment	Power Consumption	< 180 W	< 200 W	< 200 W	< 400 W
	Power Requirement	100 V to 240 VAC, 50/60 Hz	100 V to 240 VAC, 50/60 Hz	100 V to 240 VAC, 50/60 Hz	100 V to 240 VAC, 50/60 Hz
Working Environment	Operating Temperature	0 to 40 °C (0 to 104 °F)	0 to 40 °C (0 to 104 °F)	0 to 40 °C (0 to 104 °F)	0 to 40 °C (0 to 104 °F)
	Operating Humidity	10% to 90% (non-condensing)	10% to 90% (non-condensing)	10% to 90% (non-condensing)	10% to 90% (non-condensing)
Working Environment	Dimension (W×H×D)	1299.9 mm × 810.8 mm × 96.7 mm	1505 mm × 907 mm × 114 mm	1737 mm × 1040 mm × 103 mm	1990 mm × 1186 mm × 117 mm

Digital Signage

Diversified Advertisement Media Player

- > Flexible and efficient advertisement display and management
- > Ready-to-go design templates
- > Cross-network management
- > Environmentally-friendly “green” advertising
- > Multiple applications to suit various business scenarios



Model	DS-D6032FN-B	DS-D6043FN-B	DS-D6055FN-B	DS-D6043FL-B/S	DS-D6055FL-B/S	DS-D60C-B	
Image							
Display	Screen Size	31.5 inch	42.5 inch	54.5 inch	42.5 inch	54.5 inch	-
	Screen Active Zone	*698.4 (H) x 392.85 (V) mm (27.50 x 15.47 inch)*	940.896 (H) x 529.254 (V) mm (37.04 x 20.84 inch)	1209.6 (H) x 680.4 (V) mm (47.6 x 26.8 inch)	529.25 (H) x 940.90 (V) mm (20.84 x 37.04 inch)	1209.6 (H) x 680.4 (V) mm (47.6 x 26.8 inch)	-
	Backlight	ELED backlight	LED backlight	LED backlight	LED backlight	LED backlight	-
	Pixel Pitch	0.36375 mm x 0.36375 mm	0.163 x 0.490 mm	0.21 x 0.63 mm	0.163 x 0.490 mm	0.21 x 0.63 mm	-
	Resolution	1920 x 1080@60 Hz	1920 x 1080 @ 60 Hz	1920 x 1080 @ 60 Hz	1920 x 1080 @ 60 Hz	1920 x 1080 @ 60 Hz	1920 x 1080p @ 30 Hz, 1920 x 1080p @ 50 Hz, 1920 x 1080p @ 60 Hz, 1280 x 720p @ 30 Hz, 1280 x 720p @ 50 Hz, 1280 x 720p @ 60 Hz, 3840 x 2160p @ 30 Hz, 3840 x 2160p @ 50 Hz, 3840 x 2160p @ 60 Hz (YCbCr420), 3840 x 2160p @ 60 Hz, 3840 x 2160p @ 50 Hz (YCbCr420)
	Brightness	380 cd/m ²	450 cd/m ²	450 cd/m ²	450 cd/m ²	450 cd/m ²	-
	Visual Angle	Horizontal: 178°, Vertical: 178°	Horizontal: 178°, Vertical: 178°	Horizontal: 178°, vertical: 178°	Horizontal: 178°, Vertical: 178°	Horizontal: 178°, Vertical: 178°	-
	Color Depth	8 bit	8 bit	8 bit	8 bit	8 bit	-
	Contrast	1200:1	1200:1	3500: 1	1200:1	3500 : 1	-
	Response Time	8 ms	8 ms	6.5 ms	8 ms	6.5 ms	-
Refresh Rate	60 Hz	60 Hz	60 Hz	60 Hz	60 Hz	-	
Color Gamut	68% NTSC	72% NTSC	16.7 M	72% NTSC	72% NTSC	-	
Built-in System	CPU	Cortex-A17, 4-core, 1.8 GHz	Cortex-A17, 4-core, 1.8 GHz	4-core Cortex-A17, main screen 1.8 GHz	Cortex-A17, 4-core, 1.8 GHz	Cortex-A17, 4-core, 1.8 GHz	4-core Cortex-A17
	Memory	2 GB	2 GB	2 GB	2 GB	2 GB	2 GB
	SD Card	8 GB EMMC, TF 32 GB	8 GB EMMC, TF 32 GB, Max. 128 GB	8 GB EMMC, 32 GB TF Card	8 GB EMMC, TF 32 GB, Max. 128 GB	8 GB EMMC, 32 GB TF Card	8 GB EMMC, 32 GB TF Card
Interface	Video & Audio Output	*1 x AUDIO 2 x Built-in loudspeakers*	1 x AUDIO 2 x Built-in loudspeakers	1 x AUDIO	1 x AUDIO 2 x Built-in loudspeakers	1 x AUDIO 2 x Built-in loudspeakers	1 x AUDIO 1 x HDMI
	Network Interface	1 x LAN, Wi-Fi	1 x LAN, Wi-Fi	1 x LAN	1 x LAN, Wi-Fi	1 x LAN, Wi-Fi	1 x LAN
	Data Transmission Interface	2 x USB, 1 x TF Card	2 x USB, 1 x TF Card, 1 x Bluetooth	2 x USB 2.0 interface	2 x USB, 1 x TF Card	2 x USB, 1 x TF Card	2 x USB 2.0 interface
General	Power	100 to 240 VAC, 50 or 60 Hz	100 to 240 VAC, 50 or 60 Hz	100 to 240 VAC, 50 or 60 Hz	100 to 240 VAC, 50 or 60 Hz	100 to 240 VAC, 50 or 60 Hz	12 VAC, 2 A
	Power Consumption	≤ 75 W	≤ 95 W	≤ 118 W	≤ 150 W	≤ 150 W	≤ 20 W
	Standby Consumption	≤ 10 W	≤ 10 W	≤ 1 W	≤ 10 W	≤ 10 W	≤ 1 W
	Working Temperature	0 °C to 40 °C (32 °F to 104 °F)	0 °C to 40 °C (32 °F to 104 °F)	0 °C to 40 °C (32 °F to 104 °F)	0 °C to 40 °C (32 °F to 104 °F)	0 °C to 40 °C (32 °F to 104 °F)	0 °C to 50 °C (32 °F to 122 °F)
	Working Humidity	10% to 80% RH	10% to 90% RH	10% to 90% RH	10% to 90% RH	0% to 90%	10% to 90%
	Product Dimensions	723.24 (H) mm x 423.25 (V) mm x 61.5 (D) mm	967.18 x 555.42 x 67.14 mm	1237.2 x 708 x 66.54 mm	589.74 x 1717 x 55 mm	740.78 x 1878.2 x 55 mm	145 x 145 x 31.89 mm
	Packing Dimensions	898 mm x 152 mm x 544 mm	1172 x 725 x 212 mm	1403 x 898 x 263 mm	765 x 1935 x 303 mm	916 x 2100 x 303 mm	188 x 176 x 101 mm
Weight	*Net weight: 5.90 Kg (13.01 lb) Gross weight: 8.60 Kg (18.96 lb)	Net weight: 16.1 kg (35.49 lb.) Gross weight: 18.24 kg (40.21 lb.)	Net weight: 23 kg (50.7 lb.) Gross weight: 24 kg (52.9 lb.)	Net weight: 48.46 kg (106.84 lb.) Gross weight: 63.46 kg (139.91 lb.)	Net weight: 66.190 kg (145.92 lb.) Gross weight: 81.190 kg (178.99 lb.)	Net weight: 0.6 kg (1.3 lb.) Rough weight: 0.65 kg (1.4 lb.)	

Decoder









Decoder

Dynamic and Secure Video Stream

- > Multiple output interfaces
- > Supports various video compression formats
- > Decoding capability up to 128-ch 1080p
- > Supports splicing, cross-window, division, and roaming modes
- > Video wall controlling up to 16 screens



DS-6900 Series

Model	DS-6901UDI	DS-6904UD(B)	DS-6908UD(B)	DS-6910UD(B)	DS-6912UD(B)	DS-6916UD(B)
Image	 NEW	 NEW	 NEW	 NEW	 NEW	 NEW
Video Stream Format Supported	H.265+/H.265, H.264+/H.264, Hik264, MPEG4 and MJPEG					
Audio Stream Format Supported	G.722, G711A, G726, G711U, MPEG2-L2, and AAC					
Decoding Capability	12 MP @ 20 fps: 2-ch 8 MP @ 30 fps: 4-ch 5 MP @ 30 fps: 6-ch 3 MP @ 30 fps: 10-ch 1080p @ 30 fps: 16-ch	12 MP @ 20 fps: 4-ch 8 MP @ 30 fps: 8-ch 5 MP @ 30 fps: 12-ch 3 MP @ 30 fps: 20-ch 1080p: 36-ch 720p: 72-ch	12 MP @ 20 fps: 8-ch 8 MP @ 30 fps: 16-ch 5 MP @ 30 fps: 24-ch 3 MP @ 30 fps: 40-ch 1080p @ 30 fps: 64-ch	12 MP @ 20 fps: 10-ch 8 MP @ 30 fps: 20-ch 5 MP @ 30 fps: 30-ch 3 MP @ 30 fps: 50-ch 1080p @ 30 fps: 80-ch	12 MP @ 20 fps: 12-ch 8 MP @ 30 fps: 24-ch 5 MP @ 30 fps: 36-ch 3 MP @ 30 fps: 60-ch 1080p @ 30 fps: 96-ch	12 MP @ 20 fps: 16-ch 8 MP @ 30 fps: 32-ch 5 MP @ 30 fps: 48-ch 3 MP @ 30 fps: 80-ch 1080p @ 30 fps / 3 Mbps: 128-ch
Split Screen	1/4/6/8/9/12/16	1/2/4/6/8/9/12/16/25/36	1/4/6/8/9/12/16/25/36			
VGA Output	1080p: 1920 × 1080 @ 50/60 Hz WSXGA: 1680 × 1050 @ 60 Hz SXGA: 1280 × 1024 @ 60 Hz 720p: 1280 × 720 @ 50/60 Hz	-				
BNC Output	1-ch	PAL: 704 × 576, NTSC: 704 × 480				
HDMI Output	1-ch	2-ch, 1-ch DB15	4-ch, 1-ch DB15	5-ch, 2-ch DB15	6-ch, 2-ch DB15	8-ch, 2-ch DB15
Video Input	VGA, DVI-I: 1080p: 1920 × 1080@50/60 Hz, 720p: 1280 × 720@50 Hz/60 Hz	4K: 3840 × 2160@30 Hz (only for HDMI), 1080p: 1920 × 1080@50/60 Hz, 720p: 1280 × 720@50 Hz/60 Hz	VGA, DVI-I: 1080p: 1920 × 1080@50/60 Hz, 720p: 1280 × 720@50 Hz/60 Hz			
CVBS Output	-					
Audio Output	1-ch	4 (DB15 × 1)	8 (DB15 × 1)	10 (DB15 × 2)	12 (DB15 × 2)	16 (DB15 × 2)
Network Interface	1 (10/100/1000 Mbps self-adaptive Ethernet interface)	RJ45 interface × 1, 10/100/1000 Mbps adaptive Optic interface × 1, 100 base-FX/1000 base-X An RJ45 interface and an optic interface form a combo.	RJ45 interface × 2, 10/100/1000 Mbps adaptive Optic interface × 2, 100 base-FX/1000 base-X An RJ45 interface and an optic interface form a combo.			
Serial Interface	1 RS-232 (RJ45), 1 RS-485					
Two-Way Audio In	1-ch, 3.5 mm connector (2.0 Vp-p, 1 KΩ)	-		1-ch, 3.5 mm connector (2.0 Vp-p, 1 KΩ)		
Two-Way Audio Out	1-ch, 3.5 mm connector (2.0 Vp-p, 1 KΩ)	-		1-ch, 3.5 mm connector (2.0 Vp-p, 1 KΩ)		
Alarm In	8	-		8		
Alarm Out	8	-		8		
Dimensions (W×D×H)	220 mm × 148 mm × 45 mm [8.66 inch × 5.83 inch × 1.77 inch]	440 mm × 320.8 mm × 44.5 mm [17.32 inch × 12.63 inch × 1.75 inch]		440 mm × 321 mm × 88 mm [17.32 inch × 12.64 inch × 3.46 inch]		

Video Wall Controller





Video Wall Controller

All You Need to See, All the Time

- > A signal source can be displayed on M × N (M ≥ 1, N ≥ 1) display units
- > Multiple signal input sources: VGA, DVI, HDMI, YpbPr, DP
- > Built-in matrix, one signal displays on multiple windows
- > Window division, splicing, roaming, cross-window
- > Supports 1/4/9/16 window division modes and full-screen window switching



Model		DS-C10S-S11T	DS-C10S-S22T
Image			
Hardware	Slot Number	11 [6 × Input, 5 × Output]	22 [12 × Input, 10 × Output]
	Network Interface	One 10M/100M/1000M self-adaptive Ethernet interface	
Motherboard (DS-C10SMSUT)	USB Interface	1 × USB 2.0 (Reserved)	
	RS-232 Serial Interface	2	
Network Decoding Board (DS-C10S-SIUT)	Decoding Performance	Resolution: 2-ch @ 8 MP (low frame rate) or 2-ch @ 6 MP or 2-ch @ 5 MP or 8-ch @ 1080p or 16-ch @ 720p, or 32-ch @ D1 Format: H.265, H.264, Mpeg4, etc.	
	Interface	4 × DVI interface	
DVI Input Board (DS-C10S-DI4T)	DVI Input Resolution	Custom resolution, 720p @ 50 Hz, 720p @ 60 Hz, 1024 × 768 @ 60 Hz, 1024 × 768 @ 75 Hz, 1280 × 1024 @ 60 Hz, 1280 × 1024 @ 75 Hz, 1366 × 768 @ 60 Hz, 1400 × 1050 @ 60 Hz, 1080p @ 50 Hz, 1080p @ 60 Hz, UXGA @ 60 Hz, 1920 × 1200 @ 60 Hz	
	Interface	4 × VGA interface	
VGA Input Board (DS-C10S-VI4T)	RGB Input Resolution	720p @ 60 Hz, 1024 × 768 @ 60 Hz, 1024 × 768 @ 75 Hz, 1280 × 1024 @ 60 Hz, 1280 × 1024 @ 75 Hz, 1366 × 768 @ 60 Hz, 1400 × 1050 @ 60 Hz, 1080p @ 60 Hz, UXGA @ 60 Hz, 1920 × 1200 @ 60 Hz The VGA to DVI adaptor is required for VGA input.	
	Interface	4 × HDMI interface	
HDMI Input Board (DS-C10S-HI4T)	DVI Input Resolution	Custom resolution, 1024 × 768 @ 60 Hz, 1024 × 768 @ 75 Hz, 1280 × 720 @ 50 Hz, 1280 × 720 @ 60 Hz, 1280 × 1024 @ 60 Hz, 1280 × 1024 @ 75 Hz, 1366 × 768 @ 60 Hz, 1400 × 1050 @ 60 Hz, 1600 × 1200 @ 60 Hz, 1920 × 1080 @ 50 Hz, 1920 × 1080 @ 60 Hz, 1920 × 1200 @ 60 Hz, 3840 × 2160 @ 30 Hz, Only No. 1 and 3 interfaces support 3840 × 2160 @ 30 Hz	
	Input	4 × YPBPr interface	
YPbPr Input Board (DS-C10S-YI4T)	DVI Input Resolution	576p50, 480p60, 720p50, 720p60, 1080p50, 1080p60 The DVI to YPBPr adaptor is required for YPBPr input.	
	Interface	4 × DP interface	
DP Input Board (DS-C10S-DPI4T)	DP Input Resolution	Custom resolution, 1024 × 768 @ 60 Hz, 1024 × 768 @ 75 Hz, 1280 × 720 @ 50 Hz, 1280 × 720 @ 60 Hz, 1280 × 1024 @ 60 Hz, 1280 × 1024 @ 75 Hz, 1366 × 768 @ 60 Hz, 1400 × 1050 @ 60 Hz, 1600 × 1200 @ 60 Hz, 1920 × 1080 @ 50 Hz, 1920 × 1080 @ 60 Hz, 1920 × 1200 @ 60 Hz, 3840 × 2160 @ 30 Hz, Only No. 1 and 3 interfaces support 3840 × 2160 @ 30 Hz	
	Interface	4 × DVI interface	
DVI Output Board (DS-C10S-DO4T)	DVI Output Resolution	1024 × 768 @ 60 Hz, 1024 × 768 @ 75 Hz, 1366 × 768 @ 60 Hz, 1400 × 1050 @ 60 Hz, 1920 × 1200 @ 60 Hz, 720p @ 60 Hz, 1080p @ 60 Hz	
	Interface	4 × VGA interface	
VGA Output Board (DS-C10S-VO4T)	VGA Output Resolution	1024 × 768 @ 60 Hz, 1024 × 768 @ 75 Hz, 1366 × 768 @ 60 Hz, 1400 × 1050 @ 60 Hz, 1920 × 1200 @ 60 Hz, 720p @ 60 Hz, 1080p @ 60 Hz The DVI to VGA adaptor is required for VGA output.	
	Interface	4 × HDMI interface	
HDMI Output Board (DS-C10S-HO4T)	HDMI Output Resolution	1024 × 768 @ 60 Hz, 1024 × 768 @ 75 Hz, 1366 × 768 @ 60 Hz, 1400 × 1050 @ 60 Hz, 1920 × 1200 @ 60 Hz, 720p @ 60 Hz, 1080p @ 60 Hz	
	Power Supply	100 to 240 VAC, 50 or 60 Hz A built-in power supply	Built-in redundant power supply
Others	Consumption	≤ 250 W [full-loaded]	
	Working Temperature	+0° C to +50° C [+32° F to +122° F]	
	Working Humidity	10% to 90% [non-condensing]	
	Chassis	Standard 4U chassis	Standard 8U chassis
	Dimension	352 × 177 × 442.4 mm [13.9 × 7 × 17.4 inch]	352 × 354 × 442.4 mm [13.9 × 13.9 × 17.4 inch]
	Weight	≤ 20 kg [full-loaded]	
			≤ 35 kg [full-loaded]

Software

- 119** HikCentral Professional
- 120** HikCentral Enterprise–Commercial
- 121** HikCentral Enterprise–Retail
- 122** HikCentral Enterprise–Industrial
- 123** HikCentral Enterprise–Education
- 124** HikCentral Master
- 125** HikCentral–Workstation
- 127** Blazer Pro



HikCentral Professional

Versatile Security in One Platform

HikCentral Professional, Hikvision’s software platform for integrating and managing security systems, is designed to meet a variety of security challenges in one place. With this advanced platform, users can manage individual systems such as video security, access control, security alarms, and more, as well as explore cross-system functionalities. While facilitating protection of people and property, HikCentral Professional makes daily operations more efficient and helps users of all kinds make smarter decisions.

- Simplifies Deployment and Maintenance – With a minimum system requirement of Intel i3 CPU and 8 GB RAM, you can have your own security platform deployed with limited hardware cost. Moreover, maintenance of the whole system is much easier with visualized health monitoring in real time.
- Facilitates Hassle-free Integration – Through an open architecture design and a series of highly adaptive OpenAPI interfaces, you will enjoy hassle-free integration with a wide range of third-party systems such as ARC and payroll systems.
- Streamlines Operations and Management – With situational awareness powered by informative dashboards and interactive E-maps, optimal approaches advised by operation wizards, and the flexibility of a user-defined control panel, you will make smarter decisions fluidly and efficiently.
- Scales as Business Grows – By virtue of a flexible and scalable architecture, the platform can be scaled as your business needs evolve. You can expand it from a small 32-channel, 8-door system to an ultra-large-scale system that links up to 100,000 channels of equipment (under the RSM mode).

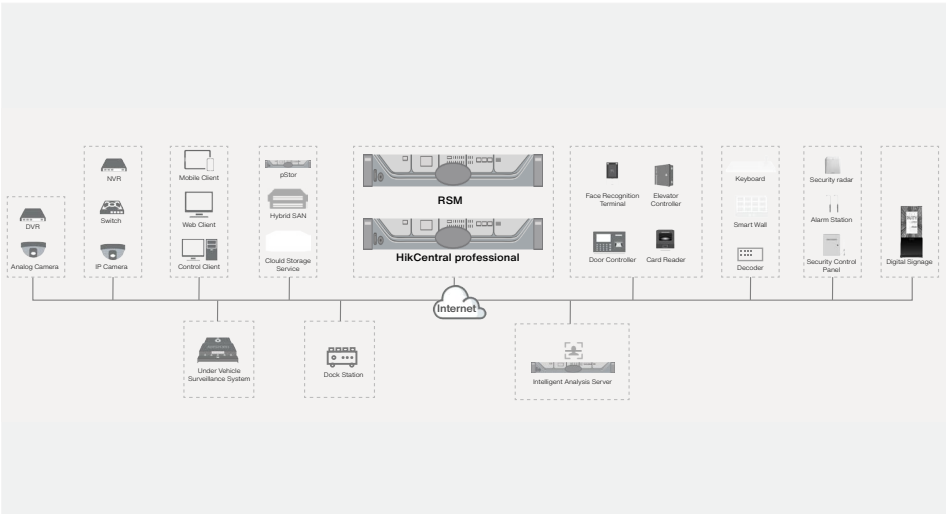

Software	
System Architecture	Server / Web Client / PC Client / Mobile APP
OS	Microsoft® Windows 7 SP1 (64-bit) Microsoft® Windows 8.1 (64-bit) Microsoft® Windows 10 (64-bit) Microsoft® Windows Server 2008 R2 SP1 / 2012 / 2012 R2 / 2016 / 2019 (64-bit)
Browser	Internet Explorer 10/11 and above Chrome 61 and above Firefox 57 and above Safari 11 and above (running on Mac OS X 10.3/10.4)
Database	PostgreSQL V9.6.13
Supported Language	25 languages: English, 简体中文 (Simplified Chinese),Русский (Russian),Български (Bulgarian),Magyar (Hungarian),Deutsch (German),Italiano (Italian),Čeština (Czech),Français (French),Polski (Polish),Nederlands (Dutch),Português (Portuguese),Português (Portuguese),Español (Spanish),Dansk (Danish),Suomi (Finnish),Türkçe (Turkish), 한국어 (Korean), 繁體中文 (Traditional Chinese),ภาษาไทย (Thai),Tiếng Việt(Vietnamese), 日本語 (Japanese),[Arabic] العربية,Українська (Ukrainian),(Hebrew)
Hardware	
CPU	Intel® Core™ i5-4590 @ 3.30 GHz 3.30 GHz
Memory	8 GB
HDD	At least 650 GB

HikCentral Professional Maximum Performance		
General	Managed Devices	General Performance: 1,024 ① High Performance: 2,048 ②
	Areas	3,000
Users and Roles	Users	3,000
	Roles	3,000
	Persons	50,000
Person	Cards	250,000
	Fingerprints	200,000
	Profiles	50,000
Video Surveillance	Cameras	General Performance: 3,000 ① High Performance: 10,000 ② High Performance (RSM): 100,000
	Decoding Devices	32
	Smart Walls	32
Face Comparison	Persons with Profiles for Face Comparison	1,000,000
	Face Comparison Groups	64
Access Control	Access Points (Doors + Floors)	1,024
	Access Schedules	32
Visitor	Visitors	10,000
	Shift Schedules	128
Time & Attendance	Persons for Time and Attendance	10,000
	Attendance Reports	16
Entrance & Exit	Lanes	8
	Cards Linked with Vehicles	250,000
	Vehicle Passing Frequency in Each Lane	1 Vehicle/s
Alarm	Alarms	60 million
	Alarms Sent to All Clients	120/s

①: The general performance requires Intel® Xeon® E3-1220 or higher.
②: The high performance requires Intel® Xeon® E5-2620 or higher.

HikCentral Enterprise-Commercial

Platform Solution Tailored for Commercial Buildings

HikCentral Enterprise-Commercial is a video-based software platform focused on commercial real estate, providing video security, access control, video intercom, alarm, operations and maintenance support, parking lot management, and other functions through centralized management, multiple applications, and intelligent analytics.

- > **Video-Based Security** – Using HikCentral’s functional modules for live viewing, playback, smart video walls, and PTZ control, this system helps users complete daily security inspections and monitoring.
- > **Access Control** – The integrated system includes access control, elevator control, visitor management, video intercom, patrols, and other functions to help users manage the access permissions of various personnel and formulate patrol tasks.
- > **Vehicle Control** – Entrance and exit management, parking lot management, parking guidance, checkpoint violation management, etc., constitute a vehicle control system so users can build their own parking payment and violation management system.
- > **Event Management** – Highly flexible event & alarm modules and a powerful map-based monitoring module can help users take precautions before an event occurs, and even intervene in an event in real time. Intelligent event search functions facilitate post-event investigations as well.
- > **Operation and Maintenance** – Users can check the status of various devices and services in real time, troubleshooting and making repairs in a timely manner wherever and whenever needed.



Software	
System Architecture	Server / Web Client / PC Client / Mobile APP
OS for Server	CentOS 7.2 64 bit / CentOS 7.4 64 bit / CentOS 7.6 64 bit
OS for Client	Microsoft® Windows 7 (32/64 bit)
	Microsoft® Windows 10 (64 bit)
Browser	Internet Explorer 11 and above
	Chrome 63.0.3239.108 and above
Supported Language	2 languages: English, 简体中文 [Simplified Chinese] [Ukrainian],[Hebrew]
Hardware	
CPU	CPU: 2.1G, 8C/16T
Memory	64 GB
HDD	HDD: 1T SATA × 2, 3.5" Enterprise SATA 7.2k HDDs
NIC	1GbE * 4

HikCentral Enterprise-Commercial Maximum Performance		
	Items	Max Performance
General	Organizations	50000
	Areas	20000
	Users	200000
	Roles	10000
	Persons	300000
	Cards	300000
Video Security	Channels for Video Surveillance	100000
	Smart Walls	10
	Screens per Video Wall	25 * 25
Event & Alarm	Event Storage	72000000
	Simultaneous Events	300/s
Intrusion	Security Control Panels	100
	Zones	1000
Facial Application	Face Capture Cameras	500
	Faces	300000
	Face Groups	16
Attendance	Face Pictures per Face Group	30000
	People for Attendance	200,000
Video Intercom	Residences	10000
	Parking Lots	20
Parking	Lanes	60
	Parking Spaces in Total	10000
	Parking Spaces per Floor	2000
Campus Checkpoint	Registered Vehicles	30000
	Checkpoints	30
Central Storage	Display Screens	30
	Channels	100000

HikCentral Enterprise-Retail

Platform Solution for Retail Business Intelligence

HikCentral Enterprise-Retail is a store auditing software that combines reliable video security functionality with intelligent software, helping retailers improve in-store service and increase profits. It provides functions such as customer traffic analytics, customer group analytics, heat mapping, area popularity analytics, remote audits, etc., meeting the requirements of retailers who need a boost in operations, management, and more.

- > **Customer Traffic Analysis** – The retail component supports multiple customer traffic statistics, such as customer traffic analytics (face) and customer traffic analytics (conventional). And multiple customer traffic analytics, such as store ranking, YoY & MoM analytics, customer attributes, area popularity, and heat mapping. It can exclude clerks and repetitive customers for more accurate customer traffic analytics (based on faces). Customer and unauthorized-person archive management, and store visit prompts are also available by mobile.
- > **Audits and Rating** – Real-time random audits, timed random audits, on-site audits (via E-Store app), image scheduled audits, and video scheduled audits are featured. Users can submit deficiencies found in audits to the audited store for rectification. The deficiency center provides a closed-loop rectification procedure for any issues found in an audit, including rectification, submission of results, and review of the submitted results.
- > For base functionality, please refer to HikCentral Enterprise-Commercial.

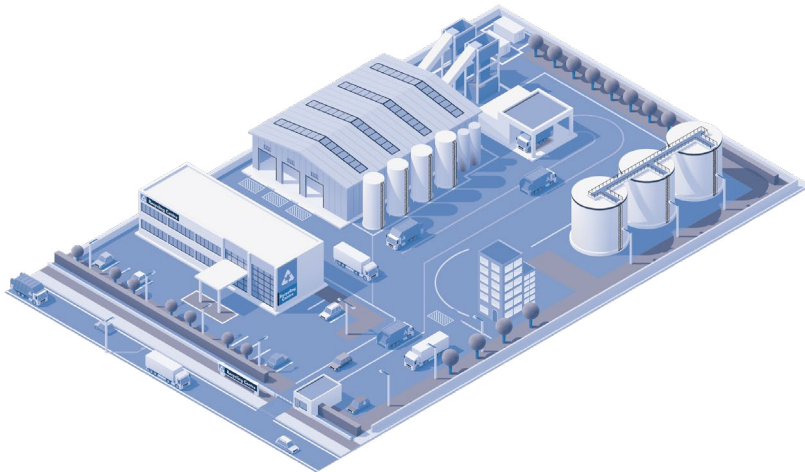

Software	
System Architecture	Server / Web Client / PC Client / Mobile APP
OS for Server	CentOS 7.2 64 bit / CentOS 7.4 64 bit / CentOS 7.6 64 bit
OS for Client	Microsoft® Windows 7 (32/64 bit)
	Microsoft® Windows 10 (64 bit)
Browser	Internet Explorer 11 and above Chrome 63.0.3239.108 and above
Supported Language	2 languages: English, 简体中文 (Simplified Chinese) (Ukrainian),(Hebrew)
Hardware	
CPU	CPU: 2.1G, 8C/16T
Memory	64 GB
HDD	HDD: 1T SATA × 4, 3.5" Enterprise SATA 7.2k HDDs
NIC	1GbE * 2

HikCentral Enterprise - Retail Maximum Performance		
	Items	Max Performance
Retail Application	Stores	500
	Archives	3,000,000 archives, including archives of customers and archives of unauthorized persons.
	Store Visit Notification Time	Within 5s in average for one notification when there are less than 1,000,000 archives; within 10s in average when there are less than 3,000,000 archives.
	Counting Groups	3000
	Cameras per Counting Group	100
	Cameras per Counting Group	100
	Accessed Dual-Lens People Counting Camera Organizations	5000 50000
General	Areas	20000
	Users	200000
	Roles	10000
	Persons	300000
	Cards	300000
Video Security	Channels for Video Surveillance	100000
	Smart Walls	10
Event & Alarm	Screens per Video Wall	25 * 25
	Event Storage	72000000
Intrusion	Simultaneous Events	300/s
	Security Control Panels	100
Facial Application	Zones	1000
	Face Capture Cameras	500
	Faces	300000
Attendance	Face Groups	16
	Face Pictures per Face Group	30000
	People for Attendance	200000
Video Intercom	Residences	10000
	Parking Lots	20
	Lanes	60
Parking	Parking Spaces in Total	10000
	Parking Spaces per Floor	2000
	Registered Vehicles	30000
Campus Checkpoint	Checkpoints	30
	Display Screens	30
Central Storage	Channels	100000

HikCentral Enterprise-Industrial

All-inclusive Platform Solution for Industrial Parks

HikCentral Enterprise-Industrial is a centralized and intelligent platform integrates and links security information by accessing video security devices, single-card system devices, parking lot devices, alarm system devices, and more, to give you diversified intelligent applications. Based on IoT technology, it integrates technologies such as video monitoring, facial recognition, AI, big data, etc., and combine hardware with software.

- Industrial Application – Goods management, dock management, AR-scenario application, AI-model management, remote patrol, thermal analysis, dashboard – it's all here. This system is suitable for industrial sites of commodities businesses, manufacturing industry, and logistics companies. Based on an "Integrated Software Framework", HikCentral Enterprise-Industrial will keep satisfying users' quickly updating needs via its advanced componential technology. This system will excel in every industry with its integration and centralized management of various resources.
- For base functionality, please refer to HikCentral Enterprise-Commercial.

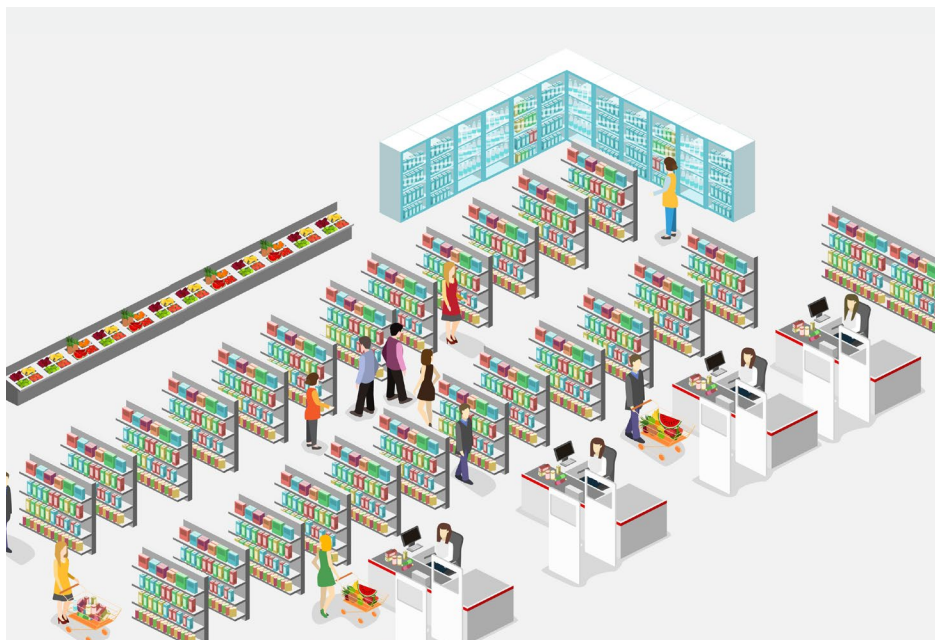

Software	
System Architecture	Server / Web Client / PC Client / Mobile APP
OS for Server	CentOS 7.2 64 bit / CentOS 7.4 64 bit / CentOS 7.6 64 bit
OS for Client	Microsoft® Windows 7 (32/64 bit)
	Microsoft® Windows 10 (64 bit)
Browser	Internet Explorer 11 and above Chrome 63.0.3239.108 and above
Supported Language	2 languages: English, 简体中文 [Simplified Chinese] [Ukrainian],(Hebrew)
Hardware	
CPU	CPU: 2.1G, 8C/16T
Memory	64 GB
HDD	HDD: 1T SATA × 4, 3.5" Enterprise SATA 7.2k HDDs
NIC	1GbE * 4

HikCentral Enterprise - Industrial Maximum Performance

	Items	Max Performance
Goods Management	Scanning Units	5000
	Thermal Analysis	Thermography Rules
AR Scenario Application	Scenes	8
	Patrol Application	Patrol Items
General	Patrol Schedules	20
	Organizations	50000
	Areas	20000
	Users	200000
	Roles	10000
	Persons	300000
Video Security	Cards	300000
	Channels for Video Surveillance	100000
	Smart Walls	10
Event & Alarm	Screens per Video Wall	25 * 25
	Event Storage	72000000
Intrusion	Simultaneous Events	300/s
	Security Control Panels	100
Facial Application	Zones	1000
	Face Capture Cameras	500
	Faces	300000
Attendance	Face Groups	16
	Face Pictures per Face Group	30000
Video Intercom	People for Attendance	200,000
	Residences	10000
Parking	Parking Lots	20
	Lanes	60
	Parking Spaces in Total	10000
Campus Checkpoint	Parking Spaces per Floor	2000
	Registered Vehicles	30000
Central Storage	Checkpoints	30
	Display Screens	30
	Channels	100000

HikCentral Enterprise-Education

Intelligent Platform Solution for Education

HikCentral Enterprise-Education is an information technology which has been developed for central management of video monitoring and education. It is a platform for collaborative teaching-learning to connect students and educators virtually and ensure uninterrupted learning with screen sharing. It features flexibility, scalability, high reliability, and powerful functions.

- > Education Application – This deep vertical application provides education sharing, classroom attendance, and classroom information release screen. The informatization of education is designed to use information technology to support the use and development of educational resources.
- > For base functionality, please refer to HikCentral Enterprise-Commercial.

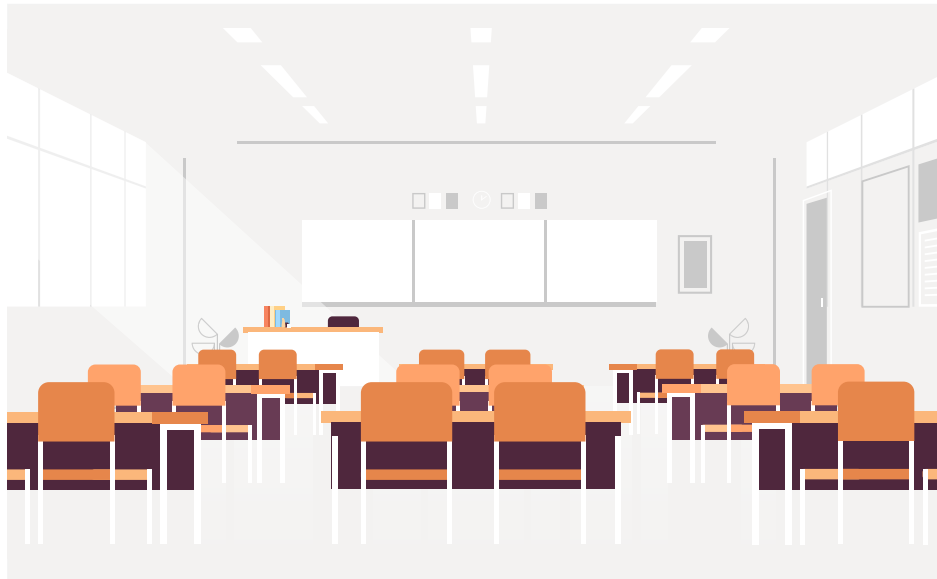

Software	
System Architecture	Server / Web Client / PC Client / Mobile APP
OS for Server	CentOS 7.2 64 bit / CentOS 7.4 64 bit / CentOS 7.6 64 bit
OS for Client	Microsoft® Windows 7 (32/64 bit)
	Microsoft® Windows 10 (64 bit)
Browser	Internet Explorer 11 and above Chrome 63.0.3239.108 and above
Supported Language	2 languages: English, 简体中文 (Simplified Chinese) (Ukrainian),(Hebrew)
Hardware	
CPU	CPU: 2.1G, 8C/16T
Memory	64 GB
HDD	HDD: 1T SATA × 2, 3.5" Enterprise SATA 7.2k HDDs
NIC	1GbE * 4

HikCentral Enterprise - Education Maximum Performance		
	Items	Max Performance
Education Application	Classrooms	100
	Teachers and Students	2000
	Education Sharing System	100
	Persons for Viewing Recorded Courses	50
	Persons for Viewing Live Courses	150
	Classroom Information Release Screen	36
	Classroom Attendance Check Camera	36
General	Organizations	50000
	Areas	20000
	Users	200000
	Roles	10000
	Persons	300000
	Cards	300000
Video Security	Channels for Video Surveillance	100000
	Smart Walls	10
Event & Alarm	Screens per Video Wall	25 * 25
	Event Storage	72000000
Intrusion	Simultaneous Events	300/s
	Security Control Panels	100
Facial Application	Zones	1000
	Face Capture Cameras	500
	Faces	300000
Attendance	Face Groups	16
	Face Pictures per Face Group	30000
	People for Attendance	200000
Video Intercom	Residences	10000
	Parking Lots	20
	Lanes	60
Parking	Parking Spaces in Total	10000
	Parking Spaces per Floor	2000
	Registered Vehicles	30000
Campus Checkpoint	Checkpoints	30
	Display Screens	30
Central Storage	Channels	100000

HikCentral Master

Comprehensive Platform Solution with Unlimited Expandability

HikCentral Master is an application platform designed for immense, fail-safe distribution of devices and services across multiple locations. Integrating AI, AR, big data, and other capabilities under the AI-Cloud architecture, HikCentral Master supports a virtually unlimited number of devices, users, and sites to meet a diversity of needs for data storage, analysis, and application.

- > Intelligent Platform Management – Supports non-stop installation, parameter configuration, server monitoring, and log analysis. Supports cluster management and authorization management.
- > Intelligent Applications – Integrating multiple function and application software, the platform extends its applications from video security to those based on AI algorithms, such as ANPR and facial recognition. This makes the platform applicable to scenarios such as public security and intelligent transportation.
- > Intelligent Scheduling – Supports dynamic scheduling of computer resources based on integrated management of computers. Supports accessing multiple types of storage devices and integrates their management. It's compatible with devices from multiple manufacturers and multiple algorithms versions
- > Open Platform – Supports integration with third-party infrastructure, data, platforms, and applications based on open standards.
- > Comprehensive Security Mechanism – Provides security mechanisms for devices, networks, host computers, data, and applications, and supports multiple security control schemes.
- > Extensibility and Scalability – Supports expanding the service capacities such as the maximum number of added devices, streaming storage, events, and data libraries. Increases capacity and stability by distributed deployment.
- > Multiple Usage Scenarios – Supports assembling various modules into bespoke platforms based on specific usage scenarios.

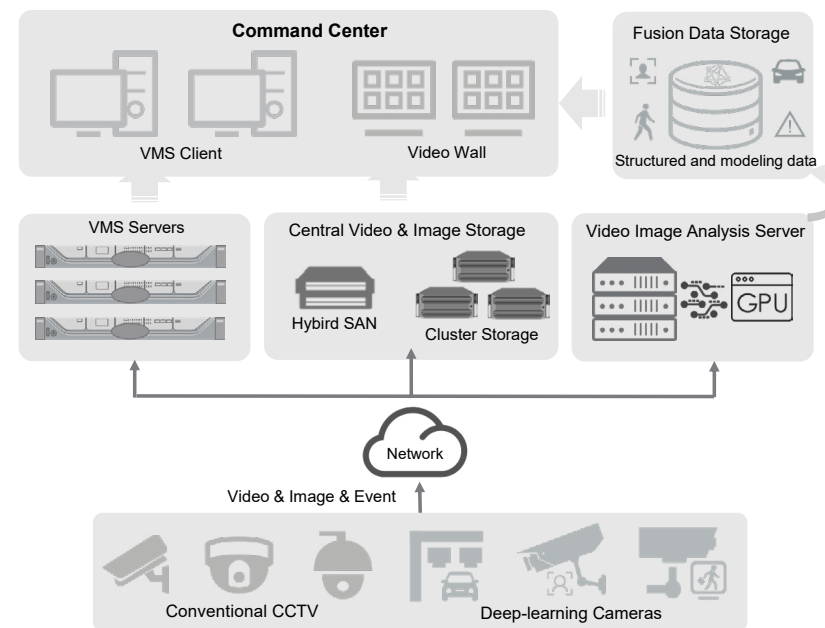

HCM

What HikCentral Master can do for you ?



HikCentral Master focuses on data application, data collection, storage, processing, and intelligent applications. It provides data integration, storage and analysis of multidimensional data in the scenario of Edge Domain and Cloud Center, integrated with technologies of Artificial Intelligence and Internet-of-Things (IoT).	
Video Center	Through video inspection, electronic map, video analysis and other technologies, the system can realize video real-time viewing and query, and conduct video map applications and analysis.
Multidimensional Data Fusion	With the functions of fusion search, face search, vehicle search and human body search basing on big data technology, the system can conduct fast query and advanced search on people and vehicles, so as to help users quickly determine personnel and vehicle information.
Intelligent Data Applications	Through AI and big data technology, the system can realize various face tactical functions such as peer analysis, personnel landing, and frequent passing, as well as vehicle tactical functions such as trajectory search, regional collision, and vehicle landing analysis.
Alarm Arming	By target arming and alarm query function, the system can realize arming on the vehicles and people, and configure corresponding alarm rules and linkage rules.
Statistics Center	Through face data statistics, vehicle data statistics, human data statistics and other big data storage and analysis technologies, the system can graphically display the multi-dimensional data friendly.
Video Maintenance and Operation & Management Center	The video maintenance module can achieve intelligent real-time monitoring of the system video running status through cameras online status detection, video content diagnosis and video record inspection. The operation & management center, as an integrator of background services, provides integration capabilities for configuration, logging, and monitoring. It can integrate the component's own monitoring and configuration interface, and provides a single sign-on service for the operation management center.
AR Application	Through AR technology, various images, videos, 3D models, etc. are superimposed on the AR PanoVu camera's view in real time to realize functions such as video labeling, video planning, high-high linkage, high-low linkage, etc., providing a more intuitive and flexible central command and management way.

HikCentral-Workstation

A Cost-Effective Product with HikCentral Professional

HikCentral-Workstation is a cost-effective unit embedded with HikCentral Professional software and Windows operating system. Combining the HikCentral Professional server and client, it creates efficient management of the live feed, playback, facial recognition, ANPR, access control, video intercom, alarm management, and more. It is used widely in small- to medium-sized projects and Hikvision's "solutions by scenario."



Model		HikCentral-Workstation/32	HikCentral-Workstation/64
Image			
Devices and Resources	Cameras *Including ANPR Cameras and Cameras with Face Capture Function	32	64
	Managed Device IP Addresses *Including Encoding Devices, Access Control Devices, Security Control Devices, and Remote Sites	128	256
	Video Intercom Devices *Including Indoor Station	8	16
	Alarm Inputs (Including Zones of Security Control Devices)	32	32
	Alarm Outputs	32	32
	Alarm Inputs of Security Control Devices	32	32
	ANPR Cameras	4	8
	Cameras with Face Capture Function	2	4
	Security Radars	2	2
	Areas	64	128
	Cameras per Area	32	64
	Alarm Inputs per Area	16	32
	Alarm Outputs per Area	16	32
	Recording	Recording Schedule	64
Recording Schedule Template		32	32
Event and Alarm Rules		128	128
Event & Alarm	Storage of Events or Alarms without Pictures	5/s	10/s
	Events or Alarms Sent to Clients *The clients include Control Clients and Mobile Clients.	"5/s 8 Clients/s"	"10/s 16 Clients/s"
	Notification Schedule Templates	100	100
Picture	Picture Storage *Including event/alarm pictures, face pictures, and vehicle pictures.	5/s	10/s
	Regular Report Rules	64	64
	Event or Alarm Rules in One Event/Alarm Report Rule	32	32
Reports	Records in One Sent Report	10,000 or 10 MB	10,000 or 10 MB
	Resources Selected in One Report *With this limitation, you can generate a neat and clear report via the Control Client and it costs less time.	20	20
	Data Retention Period	Stored for 6 Months	Stored for 6 Months
Data Storage	Concurrent Accesses via Web Clients and Control Clients	8	16
	Concurrent Accesses via Mobile Clients	8	16
	Users	8	32
Users and Roles	Roles	8	32
	Vehicle Lists	50	50
	Vehicles per Vehicle List	500	500
Entrance & Exit	Lanes	4	4
	Cards Linked with Vehicles	2,500	2,500
	Vehicle Passing Frequency in Each Lane	1 Vehicle/s	1 Vehicle/s
Face Comparison	Persons with Profiles for Face Comparison	10,000	10,000
	Face Comparison Groups	16	16
	Persons in One Face Comparison Group	1,000	1,000
Access Control	Persons with Credentials for Access Control	3,000	5,000
	Total Credentials (Card + Fingerprint)	15,000	25,000
	Cards	15,000	25,000
	Fingerprints	12,000	20,000
	Profiles	3,000	5,000
	Access Points (Doors+Outdoor Station)	8	16
	Access Groups	32	32
	Persons in One Access Group	3,000	5,000
	Access Levels	16	32
	Access Schedules	32	32

Decoding Performance of Control Client				
Resolution	HikCentral-Workstation/32		HikCentral-Workstation/64	
	Maximum Hardware Decoding Channels	Maximum Software Decoding Channels	Maximum Hardware Decoding Channels	Maximum Software Decoding Channels
1920 × 1080	6	4	8	6
2560 × 1440	3	2	5	3
3840 × 2160	1	1	2	1
2560 × 2560 (Fisheye Camera)	2	2	4	3
4000 × 4000 (Fisheye Camera)	1	1	2	1

Hardware Specification		
	HikCentral-Workstation/32	HikCentral-Workstation/64
Processor	Intel® Core™ i3-8100 (4Cores/6MB/4T/ 3.6GHz/65W);	Intel® Core™ i5-8500 (6Cores/9MB/6T/ Up to 4.1GHz/65W)
Operating Systems	Microsoft® Windows 10 IoT Ent (64-bit)	Microsoft® Windows 10 IoT Ent (64-bit)
Memory	2 × 4GB 2666MHz DDR4 UDIMM	2 × 4GB 2666MHz DDR4 UDIMM
Graphics Card	Integrated Intel® HD Graphics 630	Integrated Intel® HD Graphics 630
Storage	M.2 256GB SATA Class 20 solid state drive	M.2 256GB SATA Class 20 solid state drive
NIC	Integrated Intel I219-LM Ethernet LAN 10/100/1000	Integrated Intel I219-LM Ethernet LAN 10/100/1000
I/O Ports	10 External USB: 1 × USB Type-C 3.1 Gen 2, 5 × 3.1 Gen 1 Type-A (1 Front, 4 Rear), 4 × USB 2.0, 1 × RJ-45, 2 × Displayport, 1 × Serial, 2 × PS/2	10 External USB: 1 × USB Type-C 3.1 Gen 2, 5 × 3.1 Gen 1 Type-A (1 Front, 4 Rear), 4 × USB 2.0, 1 × RJ-45, 2 × Displayport, 1 × Serial, 2 × PS/2
Form Factor	Small Form Factor	Small Form Factor
Power Supply	300W typical 90% Efficient PSU (80 PLUS Bronze)	300W typical 90% Efficient PSU (80 PLUS Bronze)
Dimensions (H × W × D)	29cm × 9.26cm × 29.2cm	29cm × 9.26cm × 29.2cm
	(11.42" × 3.7" × 11.5")	(11.42" × 3.7" × 11.5")
Weight	7.57lbs / 5.26kg	7.57lbs / 5.26kg
Certification	CE, FCC, UL	CE, FCC, UL
Warranty	36 Months	36 Months

Blazer Pro

A Powerful, Convenient and Fail-Proof VMS Recorder

- > All-in-one recorder with powerful VMS and data storage in one unit
- > Dual board design for risk isolation and better reliability – in case of VMS server board failure, storage board works independently and recording, preview and playback functions are not affected
- > Supports facial recognition, access control, centralized video management, and business intelligence functions such as people counting, queue detection, etc.
- > Certifications: CE / CB / FCC / ICES / UL







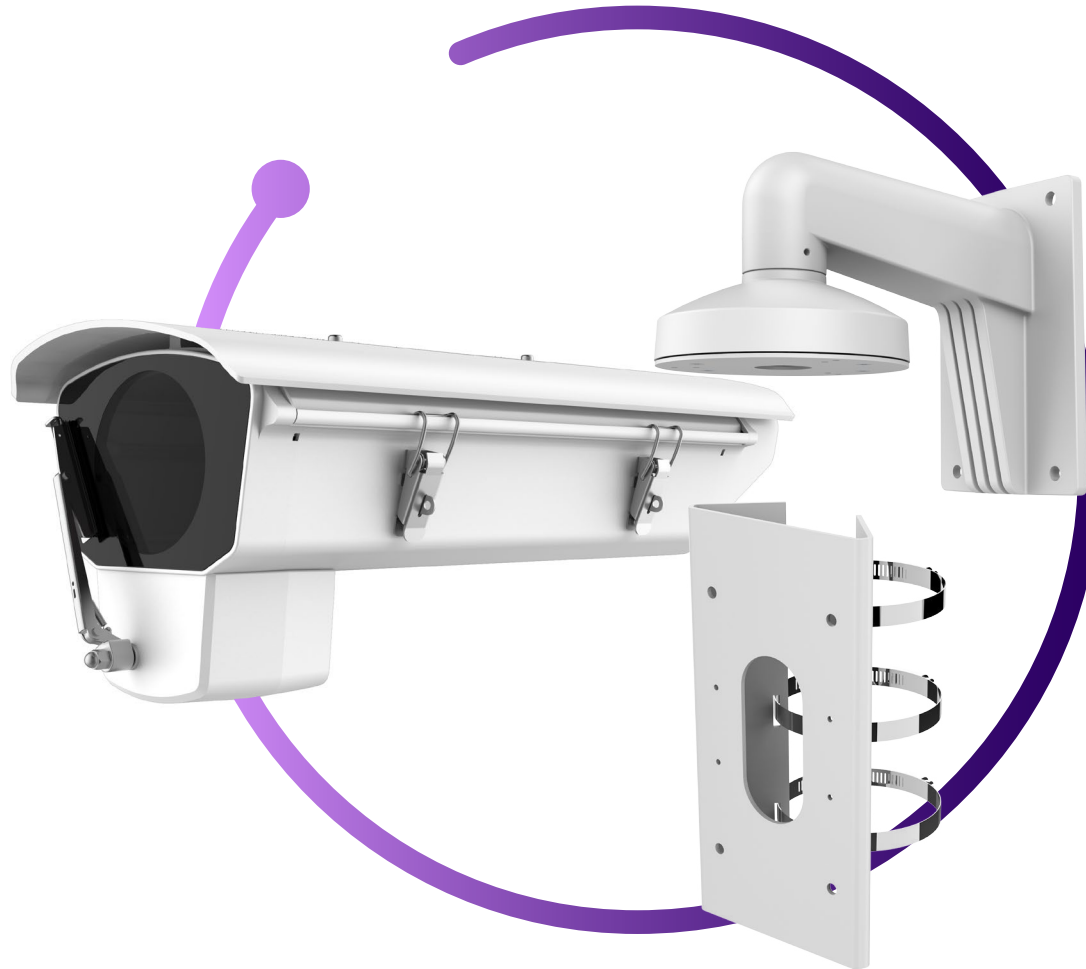



Model	Blazer Pro /256/16H	Blazer Pro /128/16H
Image		
Processor	Intel® Xeon® Quad-Core (64-bit) E3-1225 V5 CPU @ 3.30GHz	Intel® Xeon® Quad-Core (64-bit) E3-1225 V5 CPU @ 3.30GHz
Operating System	Support Microsoft Windows, including Windows 10 and Windows Server 2012 R2 Support HikCentral V1.3	Support Microsoft Windows, including Windows 10 and Windows Server 2012 R2 Support HikCentral V1.3
Memory	4 × DDR4 slots, 8 GB	4 × DDR4 slots, 8 GB
Hardware Platform	-	-
No. of Channels	256-ch	128-ch
Decoding Format	H.265, H.265+, H.264, H.264+, MPEG4, MJPEG (for Hikvision network camera only)	H.265, H.265+, H.264, H.264+, MPEG4, MJPEG (for Hikvision network camera only)
Incoming/Outgoing Bandwidth	768/768 Mbps	576/512 Mbps
Decoding Capacity	20 × 1080p (H.264 & H.265)	20 × 1080p (H.264 & H.265)
Recording Resolution	12 MP / 8 MP / 7 MP / 6 MP / 5 MP / 4 MP / 3 MP / 1080p / UXGA / 720p / VGA / 4CIF / DCIF / 2CIF / CIF / QCIF	12 MP / 8 MP / 7 MP / 6 MP / 5 MP / 4 MP / 3 MP / 1080p / UXGA / 720p / VGA / 4CIF / DCIF / 2CIF / CIF / QCIF
Display	2 HDMI / 1 VGA	2 HDMI / 1 VGA
Video Output	HDMI: 2-ch (independent output) 4K (4096 × 2160), 4K (3840 × 2160) @ 30 Hz, 2K (2560 × 1440) @ 60 Hz, 1080p (1920 × 1080) @ 60 Hz, UXGA (1600 × 1200) @ 60 Hz, SXGA (1280 × 1024) @ 60 Hz, 720p (1280 × 720) @ 60 Hz, XGA (1024 × 768) @ 60 Hz VGA: 1-ch 1080p (1920 × 1080) @ 60 Hz, UXGA (1600 × 1200) @ 60 Hz, SXGA (1280 × 1024) @ 60 Hz, 720p (1280 × 720) @ 60 Hz, XGA (1024 × 768) @ 60 Hz	HDMI: 2-ch (independent output) 4K (4096 × 2160), 4K (3840 × 2160) @ 30 Hz, 2K (2560 × 1440) @ 60 Hz, 1080p (1920 × 1080) @ 60 Hz, UXGA (1600 × 1200) @ 60 Hz, SXGA (1280 × 1024) @ 60 Hz, 720p (1280 × 720) @ 60 Hz, XGA (1024 × 768) @ 60 Hz VGA: 1-ch 1080p (1920 × 1080) @ 60 Hz, UXGA (1600 × 1200) @ 60 Hz, SXGA (1280 × 1024) @ 60 Hz, 720p (1280 × 720) @ 60 Hz, XGA (1024 × 768) @ 60 Hz
Storage Capacity	16 SATA interfaces Up to 10 TB for each HDD	16 SATA interfaces Up to 10 TB for each HDD
eSATA / Mini SAS	1 eSATA interface Optional: 2 mini SAS interface	1 eSATA interface Optional: 2 mini SAS interface
RAID Type	RAID 0, RAID 1, RAID 5, RAID 6, RAID 10	RAID 0, RAID 1, RAID 5, RAID 6, RAID 10
Video Output	1-ch, RCA (2.0 Vp-p, 1 KΩ)	1-ch, RCA (2.0 Vp-p, 1 KΩ)
Audio Output	1-ch, RCA (2.0 Vp-p, 1 KΩ)	1-ch, RCA (2.0 Vp-p, 1 KΩ)
Alarm I/O	16/8	16/8
Network Interface	4 × RJ-45 10/100/1000 Mbps self-adaptive Ethernet interfaces	4 × RJ-45 10/100/1000 Mbps self-adaptive Ethernet interfaces
PoE Port	-	-
USB Port	Front Panel: 2 × USB 2.0; Rear Panel: 2 × USB 3.0 + 2 × USB 3.0;	Front Panel: 2 × USB 2.0; Rear Panel: 2 × USB 3.0 + 2 × USB 3.0;
Smart Function	Face detection, behavior analysis, people counting and heat map	Face detection, behavior analysis, people counting and heat map
Power Consumption (without HDD)	≤ 300 W	≤ 300 W
Chassis	3U chassis of thick galvanized steel	3U chassis of thick galvanized steel
Description	-	-









Accessories











Recommended brackets for Hikvision IP camera

		Indoor			Indoor housing		Outdoor housing
	DS-2CD4C26FWD-(A P) DS-2CD4C36FWD-(A P) DS-2CD4026FWD-A/P						
		DS-1299ZJ	DS-1292ZJ	DS-1332HZ	DS-1330HZ	DS-1331HZ series	DS-1340HZ
	DS-2CD382360	Pendant mount	Wall mount	Indoor housing	Indoor housing	Outdoor housing	Outdoor housing
	DS-2CD5026G0-(AP) DS-2CD5046G0-(AP) DS-2CD5065G0-(AP) DS-2CD5085G0-(AP) DS-2CD50C5G0-(AP) DS-2CD7026G0I/PJ-(AP) DS-2CD7046G0-(AP) DS-2CD7085G0-(AP)	Hik white Aluminum alloy 77 × 77 × 198 mm 165 g	Hik white Aluminum alloy 70 × 97.1 × 217.9 mm 201 g	Hik white Aluminum alloy 288 × 149 × 100 mm 800 g	Hik white Complex fiber 290 × 142 × 92 mm 640 g	Hik white Aluminum alloy	Three-axis adjustment Containing combined wires and fan IK10







Recommended brackets for Hikvision IP camera

	<p>DS-2CD502860/E-HI</p>				
		<p>DS-1293ZJ-P</p>	<p>DS-1269ZJ-P</p>	<p>DS-1214ZJ-TP</p>	<p>DS-1233ZJ-P</p>
		<p>Wall mount</p>	<p>Pendant mount</p>	<p>Horizontal pole mount</p>	<p>Column mount</p>
		<p>Platinum gray Aluminum alloy 88 x 116.6 x 297.3 mm 473 g</p>	<p>Platinum gray Aluminum alloy 493 x 246 x 88 mm 480 g</p>	<p>Platinum gray Steel (mounting board) & Stainless Steel (clamp)</p>	<p>Platinum gray Steel Φ160 x 1093 mm 6200 g</p>
					
		<p>DS-1232ZJ-P</p>	<p>DS-1232ZJ-TP</p>	<p>DS-1275ZJ-P-SUS</p>	<p>DS-1275ZJ-SUS</p>
<p>Cardan joint</p>	<p>Cardan joint</p>	<p>Vertical pole mount</p>	<p>Vertical pole mount</p>		
<p>Platinum gray Steel 126 x 103.5 x 83 mm 790 g</p>	<p>Platinum gray Steel 96 x 95 x 92.5 mm</p>	<p>Platinum gray Stainless steel 127 x 46 x 250 mm Match up with wall mount (DS-1293ZJ-XX)</p>	<p>Hikvision white Stainless steel 127 mm x 46 mm x 250 mm (5" x 1.81" x 9.84") 1480 g (3.26 lb.) Match up with wall mount(DS-1293ZJ-XX(B))</p>		





Recommended brackets for Hikvision IP camera

	<p>DS-2CD5026G0/E-I(H) DS-2CD7026G0/EP-I(H)</p>				
		DS-1293ZJ	DS-1214ZJ	DS-1275ZJ-SUS	DS-1269ZJ
		Wall mount	Horizontal pole mount	Vertical pole mount	Pendant mount
		<p>Hik white Aluminum alloy 88 × 116.6 × 297.3mm 473 g</p>	<p>Hik white Steel (mounting board) & Stainless steel (clamp) 117 × 226 × 194 mm Diameter of clamp: Ø67-127 mm 1895 g</p>	<p>Hikvision white Stainless steel 127 mm × 46 mm × 250 mm [5" × 1.81" × 9.84"] 1480 g [3.26 lb.] Match up with wall mount (DS-1293ZJ,DS-2202ZJ)</p>	<p>Hik white Aluminum alloy 493 × 246 × 88 mm 480 g</p>
					
		DS-1233ZJ	DS-1276ZJ-SUS	DS-1674ZJ	DS-2202ZJ
		Column mount	Corner mount	Junction box	Wall mount
		<p>Hik white Steel Ø160 × 1093 mm 6200 g</p>	<p>Hik white Stainless steel 126 × 105 × 250 mm 2280 g Match up with wall mount (DS-1293ZJ,DS-2202ZJ)</p>	<p>Hikvision white Aluminum alloy 310 mm × 208.9 mm × 89 mm [12.20" × 8.22" × 3.50"] 2380 g [5.25 lb.]</p>	<p>Hikvision white Aluminum alloy ADC12 300.7 mm × 250.2 mm × 107.9 mm [9.85" × 9.85" × 4.25"] 1250 g [2.76 lb.]</p>

Recommended brackets for Hikvision IP camera

	<p>DS-2CD6026FWD/E-(H) DS-2CD6233F/E-(H)(IR5)(IRA) DS-2CD4035FWDE -(H)(IR5)(IRA)(HIR5)(HIRA) DS-2CD4065FE -(H)(IR5)(IRA)(HIR5)(HIRA) DS-2CD4085FE -(H)(IR5)(IRA)(HIR5)(HIRA) DS-2CD4026FWD -(H)(IR5)(IRA) DS-2CD4026FWD/P-L DS-2CD4026FWD/P -(IR5)(IRA)(INRA)(HIRA)(B)</p>	 <p>DS-1293ZJ</p> <p>Wall mount</p> <p>Hik white Aluminum alloy 88 × 116.6 × 297.3 mm 473 g</p>	 <p>DS-1214ZJ</p> <p>Horizontal pole mount</p> <p>Hik white Steel(mounting board) & Stainless steel (clamp) 117 × 226 × 194 mm Diameter of clamp: Ø67-127mm 1895 g</p>	 <p>DS-1275ZJ-SUS</p> <p>Vertical pole mount</p> <p>Hikvision white Stainless steel 127 mm × 46 mm × 250 mm (5" × 1.81" × 9.84") 1480 g (3.26 lb.) Match up with wall mount (DS-1293ZJ-XX(B))</p>	 <p>DS-1269ZJ</p> <p>Pendant mount</p> <p>Hik white Aluminum alloy 493 × 246 × 88 mm 480 g</p>	 <p>DS-1233ZJ</p> <p>Column mount</p> <p>Hik white Steel Ø160 × 1093 mm 6200 g</p>	 <p>DS-1276ZJ-SUS</p> <p>Corner mount</p> <p>Hik white Stainless steel 126 × 105 × 250 mm 2280 g Match up with wall mount (DS-1293ZJ-XX)</p>
-----------------------------------------------------------------------------------	----------------------------------------------------------------------------------------------------------------------------------------------------------------------------------------------------------------------------------------------------------------------------------------------------------------------------	----------------------------------------------------------------------------------------------------------------------------------------------------------------------------------------------	---------------------------------------------------------------------------------------------------------------------------------------------------------------------------------------------------------------------------------------------------------------------------------	------------------------------------------------------------------------------------------------------------------------------------------------------------------------------------------------------------------------------------------------------------------------------------------------------	-----------------------------------------------------------------------------------------------------------------------------------------------------------------------------------------------	-----------------------------------------------------------------------------------------------------------------------------------------------------------------------------------	-------------------------------------------------------------------------------------------------------------------------------------------------------------------------------------------------------------------------------------------------

Recommended brackets for Hikvision IP camera

	DS -2CD6412FWD -10/11/20/21/30/31		
		DS-1290ZJ-BL	DS-1291ZJ-BL
		Clamp bracket	Desktop/Pendant mount
	DS -2CD6424FWD -10/20/30/40(E1/E2)		
		Black Plastic 90 x 70 x 22 mm	Black Plastic 87 x 73 x 73 mm







Recommended brackets for Hikvision IP camera

	DS-2CD3063G0-I DS-2CD3043G0-I DS-2CD3023G0-I	
		Junction box
	DS-2CD3063G0-I DS-2CD3043G0-I DS-2CD3023G0-I	
		Hik white Aluminum alloy Ø100 x 43.2 x 129 mm 320 g

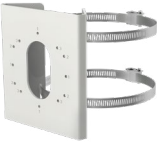

Recommended brackets for Hikvision IP camera

		Indoor/Outdoor			Outdoor	
 	DS-2CD4A26FWD-(I Z P)(I Z S P) (I Z H S P)(I L Z S P) DS-2CD4A45G0-I H S DS-2CD4B45G0-I Z S DS-2CD4B25G0-I Z S DS-2CD4B36FWD-(I Z S) DS-2CD4B26FWD-I Z S					
			DS-1275ZJ-SUS	DS-1276ZJ-SUS	DS-1275ZJ-S-SUS	Rubber sleeve
			Vertical pole mount	Corner mount	Vertical pole mount	Rubber sleeve with weather proof
		Hikvision white Stainless steel 127 mm x 46 mm x 250 mm (5" x 1.81" x 9.84") 1480 g (3.26 lb.)	Hik white Stainless steel 126 x 105 x 250 mm 2280 g	Hik white Stainless steel 144 mm x 131.6 mm x 44.3 mm (5.67" x 5.18" x 1.74") 760 g (1.68 lb.)	Hik white rubber	

Recommended brackets for Hikvision IP camera

	<p>DS-2CD3663G0-IZS DS-2CD3643G0-IZS DS-2CD3623G0-IZS DS-2CD3685G0-IZS DS-2CD3665G0-IZS DS-2CD3645G0-IZS DS-2CD3625G0-IZS</p>				
	<p>DS-2CD3683G1-IZ(S) DS-2CD3663G1-IZ(S) DS-2CD3643G1-IZ(S) DS-2CD3623G1-IZ(S) DS-2CD3685G1-IZ(S) DS-2CD3665G1-IZ(S) DS-2CD3645G1-IZ(S) DS-2CD3625G1-IZ(S)</p>	<p>DS-1475ZJ-SUS</p>	<p>DS-1476ZJ-SUS</p>	<p>DS-1275ZJ-S-SUS</p>	<p>DS-2251ZJ</p>
	<p>DS-2CD7A26G0-IZ(H)S DS-2CD5A46G0-IZ(H)S DS-2CD5A65G0-IZ(H)S DS-2CD5A85G0-IZ(H)S DS-2CD5AC5G0-IZ(H)S DS-2CD7A26G0(P)-IZ(H)S DS-2CD7A46G0(P)-IZ(H)S DS-2CD7A85G0-IZ(H)S DS-2CD5A26G1-IZ(H)S DS-2CD5A46G0-IZ(UH) DS-2CD5A46G1-IZ(H)S DS-2CD5A85G1-IZ(H)S</p>	<p>Vertical pole mount</p>	<p>Corner mount</p>	<p>Vertical pole mount</p>	<p>Column mount</p>
	<p>DS-2CD7A26G0/P-LZ(H)S</p>	<p>Hik white Stainless steel 250 mm × 127 mm × 46 mm Diameter of clamp: Ø67-127 mm 1205 g</p>	<p>Hik white Stainless steel 126 × 105 × 250 mm 2280 g</p>	<p>Hik white Stainless steel 144 mm × 131.6 mm × 44.3 mm (5.67" × 5.18" × 1.74") 760 g (1.68 lb.)</p>	<p>Hikvision white Alloy Ø 250 mm × 1570.08 mm (Ø 9.84" × 61.81") Approx. 3308 g (7.29 lb.)</p>





Recommended brackets for Hikvision IP camera

	DS-2CD5A2660-IZ(H)SY DS-2CD5A4660-IZ(H)SY DS-2CD7A2660-IZ(H)SY DS-2CD7A4660-IZ(H)SY		
		DS-1475ZJ-Y	DS-1476ZJ-Y
		Vertical pole mount	Corner mount
		Hik white Stainless steel 250 mm × 127 mm × 46 mm Diameter of clamp: Ø67-127 mm 1205 g	Hik white Stainless steel 126 X 105 X 250 mm 2280 g

Recommended brackets for Hikvision IP camera

 	DS-2CD4626FWD-IZ(H)S/P iDS-2CD8626G0/P-IZS(Y)	
		DS-1275ZJ-4626
		Vertical pole mount
		Hik white Steel (mounting board) & Stainless steel (clamp) 127 × 46 × 250 mm 1235 g



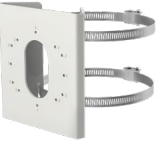



Recommended brackets for Hikvision IP camera

 	DS-2CD3T63G0-2I/4(S) DS-2CD3T43G0-2I/4(S) DS-2CD3T23G0-2I/4(S) DS-2CD3T85G0-4(S) (B) DS-2CD3T65G0-4(S) (B) DS-2CD3T45G0-4(S) (B) DS-2CD3T25G0-4(S) (B)			
		DS-1275ZJ-SUS	DS-1276ZJ-SUS	DS-1275ZJ-S-SUS
		Vertical pole mount	Corner mount	Vertical pole mount
		Hikvision white Stainless steel 127 mm × 46 mm × 250 mm [5" × 1.81" × 9.84"] 1480 g [3.26 lb.]	Hik white Stainless steel 126 × 105 × 250 mm 2280 g	Hik white Stainless steel 144 mm × 131.6 mm × 44.3 mm [5.67" × 5.18" × 1.74"] 760 g [1.68 lb.]









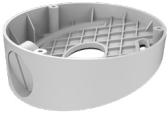

Recommended brackets for Hikvision IP camera

	DS-2CD712660-IZS DS-2CD712660/L-IZS DS-2CD714660-IZS DS-2CD718560-IZS DS-2CD512660-IZS DS-2CD514660-IZS DS-2CD516560-IZS DS-2CD518560-IZS DS-2CD51C560-IZS							
		DS-1271ZJ-130	DS-1273ZJ-130	DS-1273ZJ-130B	DS-1227ZJ	DS-1275ZJ-SUS	DS-1276ZJ-SUS	DS-1281ZJ-DM23
		Pendant mount	Wall mount	Wall mount	In-ceiling mount	Vertical pole mount	Corner mount	Inclined ceiling mount
		Hik white Aluminum alloy Ø150 × 565 mm 1900 g	Hik white Aluminum alloy 132 × 183.5 × 228.5 mm 690 g	Hik white Aluminum alloy with junction box 132 × 243 × 288.5 mm 1475 g	Hik white Aluminum alloy & ABS Plastic Ø210 × 90 mm 540 g	Hikvision white Stainless steel 127 mm × 46 mm × 250 mm (5" × 1.81" × 9.84") 1480 g (3.26 lb.) Match up with wall mount (DS-1273ZJ-XX(B))	Hik white Stainless steel 126 X 105 X 250 mm 2280 g Match up with wall mount (DS-1273ZJ-XX(B))	Hik white Aluminum alloy Ø136 × 48 mm 245 g





Recommended brackets for Hikvision IP camera

	DS-2CD354560-IS DS-2CD352560-IS						
		DS-1272ZJ-120	DS-1271ZJ-120	DS-1276ZJ-SUS	DS-1280ZJ-DM46	DS-1275ZJ-SUS	DS-1272ZJ-120B
		Wall mount	Pendant mount	Corner mount	Junction box	Vertical pole mount	Wall mount
		Hik white Aluminum alloy 120 × 122 × 173.5 mm 430 g	Hik white Aluminum alloy Ø150 × 573 mm 1900 g	Hik white Stainless steel 126 X 105 X 250 mm 2280 g Match up with wall mount (DS-1272ZJ-XX(B))	Hik white Aluminum alloy Ø 120 mm × 37.2 mm (Ø 4.72" × 1.46") 250 g	Hikvision white Stainless steel 127 mm × 46 mm × 250 mm (5" × 1.81" × 9.84") 1480 g (3.26 lb.) Match up with wall mount (DS-1272ZJ-XX(B))	Hik white Aluminum alloy with junction box 123 × 180 × 223 mm 1225 g







Recommended brackets for Hikvision IP camera

	DS-2CD316360-1(S) DS-2CD314360-1(S) DS-2CD312360-1(S) DS-2CD318560-1S DS-2CD314560-1S DS-2CD312560-1S					
		DS-1259ZJ	DS-1271ZJ-110	DS-1272ZJ-110	DS-1272ZJ-110B	DS-1276ZJ-SUS
		Inclined ceiling mount	Pendant mount	Wall mount	Wall mount	Corner mount
		Hik white ABS plastic Φ111 × 39.2 mm 200 g	Hik white Aluminum alloy Φ150 × 560 mm 1900 g	Hik white Aluminum alloy 120 × 122 × 169 mm 420 g	Hik white Aluminum alloy with junction box 123 × 180 × 227.8 mm 1205 g	Hik white Stainless steel 126 X 105 X 250 mm 2280 g Match up with wall mount (DS-1272ZJ-XX(B))
	DS-2CD312160-1					
		DS-1280ZJ-DM18	DS-1258ZJ	DS-1250ZJ	DS-1275ZJ-SUS	
	DS-2CD314160-1	Junction box	Wall mount	Rain shade	Vertical pole mount	
		Hik white Aluminum alloy Φ115.4 × 43.8 mm 450 g	Hik white ABS plastic 120 × 111 × 161.5 mm 200 g	Hik white Composite Fibre 264.7 × 152 × 189.6 mm 199 g	Hik white Stainless steel 127 mm × 46 mm × 250 mm (5" × 1.81" × 9.84") 1480 g (3.26 lb.) Match up with wall mount (DS-1272ZJ-XX(B))	







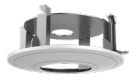

Recommended brackets for Hikvision IP camera

	DS-2CD3185G0-IMS DS-2CD3125G0-IMS					
		DS-1272ZJ-120-TR15	DS-1272ZJ-120B	DS-1271ZJ-120	DS-1276ZJ-SUS	DS-1275ZJ-SUS
		Wall mount	Wall mount	Pendant mount	Corner mount	Vertical pole mount
		Hikvision White Aluminium Alloy 120 mm × 122 mm × 173 mm (4.72" × 4.80" × 6.81") Approx. 460 g (1.01 lb.)	Hik white Aluminum alloy with junction box 123 × 180 × 223 mm 1225 g	Hik white Aluminum alloy Ø150 × 573 mm 1900 g	Hik white Stainless steel 126 X 105 X 250 mm 2280 g Match up with wall mount (DS-1272ZJ-XX(B))	Hikvision white Stainless steel 127 mm × 46 mm × 250 mm (5" × 1.81" × 9.84") 1480 g (3.26 lb.) Match up with wall mount (DS-1272ZJ-XX(B))



Recommended brackets for Hikvision IP camera

	DS-2CD3765G1-IZ(S) DS-2CD3745G1-IZ(S) DS-2CD3725G1-IZ(S) DS-2CD3783G1-IZ(S) DS-2CD3763G1-IZ(S) DS-2CD3743G1-IZ(S) DS-2CD3723G1-IZ(S)						
		DS-1471ZJ-155	DS-1473ZJ-155	DS-1475ZJ-SUS	DS-1473ZJ-155B	DS-1476ZJ-SUS	DS-1227ZJ-DM37
		Pendant mount	Wall mount	Vertical pole mount	Wall mount	Corner mount	In-ceiling mount
		Hik white Aluminum alloy Ø155 × 150 × 565 mm	Hik white Aluminum alloy 155 × 183.5 × 240 mm	Hik white Stainless steel 250 mm × 127 mm × 46 mm Diameter of clamp: Ø67-127 mm 1205 g Match up with wall mount (DS-1473Z-XX(B))	Hik white Aluminum alloy 243 × 123 × 300 mm 1750 g (3.86 lb.)	Hik white Stainless steel 126 X 105 X 250 mm 2280 g Match up with wall mount (DS-1473ZJ-XX(B))	Hik white Steel and Plastic Ø 225 mm × 98.2 mm (8.86" × 3.87") 700 g (1.54 lb.)





Recommended brackets for Hikvision IP camera

	<p>DS-2CD3785G1-IZ(S) DS-2CD3765G1-IZ(S) DS-2CD3745G1-IZ(S) DS-2CD3725G1-IZ(S) DS-2CD3783G1-IZ(S) DS-2CD3763G1-IZ(S) DS-2CD3743G1-IZ(S) DS-2CD3723G1-IZ(S)</p>							
		<p>DS-1471ZJ-155</p>	<p>DS-1473ZJ-155</p>	<p>DS-1475ZJ-SUS</p>	<p>DS-1280ZJ-DM55</p>	<p>DS-1473ZJ-155B</p>	<p>DS-1476ZJ-SUS</p>	<p>DS-1227ZJ-DM44</p>
		<p>Pendant mount</p>	<p>Wall mount</p>	<p>Vertical pole mount</p>	<p>Junction box</p>	<p>Wall mount</p>	<p>Corner mount</p>	<p>In-ceiling mount</p>
<p>Hik white Aluminum alloy Ø155 × 150 × 565 mm</p>	<p>Hik white Aluminum alloy 155 × 183.5 × 240 mm</p>	<p>Hik white Stainless steel 250 mm × 127 mm × 46 mm Diameter of clamp: Ø67-127 mm 1205 g Match up with wall mount (DS-1473Z-XX(B))</p>	<p>Hikvision white Aluminum alloy Ø 155 mm × 36 mm [Ø 6.1" × 1.42"] 300 g (0.66 lb.)</p>	<p>Hik white Aluminum alloy 243 × 123 × 300 mm 1750 g (3.86 lb.)</p>	<p>Hik white Stainless steel 126 X 105 X 250 mm 2280 g Match up with wall mount (DS-1473ZJ-XX(B))</p>	<p>Hikvision white SECC, PCABS Ø 256.1 mm × 75.9 mm [Ø 10.08" × 2.99"] Approx. 608.5 g (1.34 lb.)</p>		









Recommended brackets for Hikvision IP camera

	DS-2CD4026FWD-IZ(S) DS-2CD4036FWD-IZ(S)						
		DS-1273ZJ-DM32	DS-1271ZJ-DM32	DS-1275ZJ-SUS	DS-1276ZJ-SUS	DS-1227ZJ-DM32	
		Wall mount	Pendent mount	Vertical pole mount	Corner mount	In-ceiling mount	
Hikvision white Aluminum alloy 183.5 × 142 × 232 mm		Hikvision white Aluminum alloy Ø150 × 565 mm		Hikvision white Stainless steel 127 mm × 46 mm × 250 mm (5" × 1.81" × 9.84") 1480 g (3.26 lb.) Match up with wall mount (DS-1273ZJ-XX(B))		Hik white Stainless steel 126 X 105 X 250 mm 2280 g Match up with wall mount (DS-1273ZJ-XX(B))	











Recommended brackets for Hikvision IP camera

	DS-2CD5526G0-IZ(H)SY DS-2CD5546G0-IZ(H)SY DS-2CD7526G0-IZ(H)SY DS-2CD7546G0-IZ(H)SY				
		DS-1471ZJ-155-Y	DS-1473ZJ-155-Y	DS-1475ZJ-SUS-Y	DS-1476ZJ-SUS-Y
		Pendent mount	Wall mount	Vertical pole mount	Corner mount
Hik white Aluminum alloy Ø155 × 150 × 565 mm		Hik white Aluminum alloy 155 × 183.5 × 240 mm		Hik white Stainless steel 250 × 127 × 46 mm Diameter of clamp: Ø67-127 mm 1205 g Match up with wall mount (DS-1473ZJ-XX(B))	
				Hik white Stainless steel 126 X 105 X 250 mm 2280 g Match up with wall mount (DS-1473ZJ-XX(B))	

Recommended brackets for Hikvision IP camera

	<p>DS-2CD5526G0-IZIHIS DS-2CD5546G0-IZIHIS DS-2CD5565G0-IZIHIS DS-2CD5585G0-IZIHIS DS-2CD55C5G0-IZIHIS DS-2CD7526G0-IZIHIS DS-2CD7546G0-IZIHIS DS-2CD7585G0-IZIHIS DS-2CD5526G1-IZIHIS DS-2CD5546G1-IZIHIS DS-2CD5585G1-IZIHIS</p>				
		DS-1471ZJ-155	DS-1473ZJ-155	DS-1475ZJ-SUS	DS-1476ZJ-SUS
		Pendant mount	Wall mount	Vertical pole mount	Corner mount
		Hik white Aluminum alloy Ø155 × 150 × 565 mm	Hik white Aluminum alloy 155 × 183.5 × 240 mm	Hik white Stainless steel 250 mm × 127 mm × 46 mm Diameter of clamp: Ø67-127 mm 1205 g Match up with wall mount (DS-1473ZJ-XX(B))	Hik white Stainless steel 126 X 105 X 250 mm 2280 g Match up with wall mount (DS-1473ZJ-XX(B))
					
		DS-1473ZJ-155B	DS-1253ZJ-L	DS-1250ZJ	DS-1227ZJ-DM42
		Wall mount	Rain shade	Rain shade	In-ceiling mount
		Hik white Aluminum alloy 243 × 123 × 300 mm 1750 g (3.86 lb.)	Hik white Composite fibre Ø225.1 × 98 mm 198 g Match up with wall mount (DS-1473ZJ-155)	Hik white Composite fibre 264.7 × 152 × 189.6 mm 199 g	Hik white Steel and Plastic Ø 225 mm × 98.1 mm (Ø 8.86" × 3.86") 710 g (1.57 lb.)







Recommended brackets for Hikvision IP camera

	<p>DS-2CD6362F-IV(S) DS-2CD6332FWD-IV(S) DS-2CD63C2F-IV(S) DS-2CD6365G0E-IV(S) DS-2CD6365G0-IV(S) DS-2CD63C5G0E-IV(S) DS-2CD63C5G0-IV(S)</p>					
		DS-1271ZJ-DM25	DS-1273ZJ-DM25	DS-1280ZJ-DM25	DS-1281ZJ-DM25	DS-1283ZJ
		Pendant mount	Wall mount	Junction box	Inclined ceiling mount	Three axis adjustment
		Hik white Aluminum alloy Ø149.5 × 555 mm 1930 g	Hik white Aluminum alloy 183.5 × 164 × 231.7 mm 900 g	Hik white Aluminum alloy 178.5 × 164 × 41 mm 340 g	Hik white Aluminum alloy 157.1 × 164 × 45.5 mm 300 g	Hik white Aluminum alloy 167.5 × 167.5 × 48.7 mm
						
		DS-1275ZJ-SUS	DS-1276ZJ-SUS	DS-1274ZJ-DM25	DS-1281ZJ-DM25-B	
		Vertical pole mount	Corner mount	Corner mount	Pendant mount	
		Hik white Stainless steel 127 × 46 × 250 mm [5" × 1.81" × 9.84"] 1480 g [3.26 lb.] Match up with wall mount (DS-1283ZJ, DS-1273ZJ-XX(B))	Hik white Stainless steel 126 X 105 X 250 mm 2280 g Match up with wall mount (DS-1283ZJ, DS-1273ZJ-XX(B))	Hik white Aluminum Alloy & Plastic 209 × 195 × 114 mm	Hik white Aluminum alloy & Plastic 161 × 156 × 165.5 mm	

Recommended brackets for Hikvision IP camera





	DS-2CD3363G0-I DS-2CD3343G0-I DS-2CD3323G0-I							
		DS-1273ZJ-130-TRL	DS-1275ZJ-SUS	DS-1276ZJ-SUS	DS-1280ZJ-DM8	DS-1281ZJ-M	DS-1271ZJ-130-TRL	DS-1273ZJ-130B-TRL
		Wall mount	Vertical pole mount	Corner mount	Junction box	Inclined ceiling mount	Pendant mount	Wall mount
		Hik white Aluminum alloy 131 × 183.5 × 228.5 mm 890 g	Hik white Aluminum alloy 131 × 183.5 × 228.5 mm 890 g	Hik white Stainless steel 126 X 105 X 250 mm 2280 g Match up with wall mount (DS-1273ZJ-J-XX(B))	Hik white Aluminum alloy Ø126.7 mm × 35 mm Approx.: 210 g (0.46 lb.)	Hik white Aluminum alloy 157 × 165.7 × 61.8 mm 586 g	Hik white Aluminum alloy Ø150 × 567 mm	Hik white Aluminum alloy Ø 132 mm × 242.9 mm × 288.5mm (5.20" × 9.56" × 11.36") 1690 g (3.73 lb.)







Recommended brackets for Hikvision IP camera

	DS-2CD3385G0-I(B) DS-2CD3345G0-I(B) DS-2CD3325G0-I(B)						
		DS-1271ZJ-140	DS-1273ZJ-140	DS-1280ZJ-DM21	DS-1275ZJ-SUS	DS-1276ZJ-SUS	DS-1273ZJ-140B
		Pendant mount	Wall mount	Junction box	Vertical pole mount	Corner mount	Wall mount
		Hik white Aluminum alloy Ø150 × 565 mm 1900 g	Hik white Aluminum alloy 140 × 183.5 × 232 mm 703 g	Hik white Aluminum alloy 162 × 137 × 42 mm 250 g	Hik white Stainless steel 127 × 46 × 250 mm Diameter of clamp: Ø67-127 mm 1480 g Match up with wall mount (DS- 1273ZJ-XX(B))	Hik white Stainless steel 126 X 105 X 250 mm 2280 g Match up with wall mount (DS- 1273ZJ-XX(B))	Hik white Stainless steel 126 X 105 X 250 mm 2280 g Match up with wall mount (DS- 1273ZJ-XX(B))

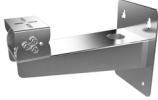



Recommended brackets for Hikvision IP camera			
	DS-2CD6626DS-IZ(H)S		
		DS-1284ZJ-M-AC	DS-1703ZJ-AC
		Junction box	Wall mount
		Natural Stainless Steel Color Stainless Steel 229 × 141 × 71.5 mm 1981 g	Natural stainless steel color Stainless steel Ø175.8 × 116.5 × 202 mm

Recommended brackets for Hikvision IP camera			
	DS-2XC6122FWD-IS DS-2XC6142FWD-IS		
		DS-1705ZJ-DM35-Y	DS-1284ZJ-M-AC
		Wall mount	Junction box
		Natural Stainless Steel Color Stainless Steel 180 × 74 × 150 mm Approx. 498 g (1.1 lb.)	Natural Stainless Steel Color Stainless Steel 229 × 141 × 71.5 mm 1981 g





Recommended brackets for Hikvision IP camera			
 	DS-2CD6626B-IZH(R)S DS-2CD6652B-IZHS		
		DS-1701ZJ-AC	DS-1284ZJ-M-AC
		Wall mount	Junction box
		Natural stainless steel color Stainless steel 140 × 228 × 412.5 mm	Natural stainless steel color Stainless steel 229 × 141 × 71.5 mm 1981 g

Recommended brackets for Hikvision IP camera							
	DS-2XE6222F-IS DS-2XE6242F-IS						
		DS-1704ZJ	DS-1706ZJ	DS-2780ZJ-X	DS-1712ZJ	DS-1677ZJ-XS-1.0 (D)	DS-1751ZJ
		Wall mount	PT joint	Explosion-proof terminal box	Pendant mount	Flexible conduit	Vertical pole mount
		Natural stainless steel color 304L Stainless steel 412.5 × 140 × 228 mm	Natural stainless steel color Stainless steel 85 × 60 × 55 mm	Stainless steel 272 mm × 272 mm × 96.8 mm 6.4 kg	Natural stainless steel color 304 stainless steel	NBR, braided steel wire, carbon steel Ø25 mm × 1000 mm	Unpainted stainless steel SUS304 350 mm × 221 mm × 87.2 mm (13.78" × 8.70" × 3.43") Approx. 5 kg (11.02 lb.) Match up with wall mount (DS-1704ZJ)





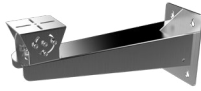

Recommended brackets for Hikvision IP camera				
	DS-2XE6222F-IS/316L DS-2XE6242F-IS/316L			
		DS-2780ZJ-X/316L	DS-1704ZJ-Y	DS-1677ZJ-XS-1.0 (D)
		Explosion-proof terminal box	Wall mount	Flexible conduit
		Stainless steel 272 mm × 272 mm × 96.8 mm 6.4 kg	Unpainted stainless steel SUS316L 412.5 mm × 140 mm × 228 mm (16.24" × 5.51" × 8.98") 2160 g (4.76 lb.)	NBR, braided steel wire, carbon steel Ø25 mm × 1000 mm





Recommended brackets for Hikvision IP camera			Recommended brackets for Hikvision IP camera
 	DS-2XC622460-L DS-2XC622560-L		
		DS-1706ZJ	DS-1279ZJ
		PT joint	Extendable pole for pendant mount
		Natural stainless steel color Stainless steel 85 × 60 × 55 mm	Hik white Aluminum alloy 250 mm Match up with pendant mount (DS-1271ZJ-XXX, DS-1471ZJ-XXX)

Recommended brackets for Hikvision IP camera

	DS-2XE6422FWD-IZH(R)S DS-2XE6452F-IZH(R)S				
		DS-1707ZJ-Y	DS-2780ZJ-X/316L	DS-1707ZJ-Y-E	DS-1677ZJ-XS-1.0 (D)
		Wall mount	Explosion-proof terminal box	Wall mount	Flexible conduit
		Unpainted stainless steel SUS316L 562.5 mm × 180 mm × 309 mm (22.15" × 7.09" × 12.17") 7.02 kg (15.48 lb.)	Stainless steel stainless steel 316L 272 mm × 272 mm × 96.8 mm 6.4 kg	Unpainted stainless steel SUS316L 543.5 mm × 160 mm × 258 mm (21.40" × 6.30" × 10.16") 4.98 kg (10.98 lb.)	NBR, braided steel wire, carbon steel Ø25 mm × 1000 mm



Recommended brackets for Hikvision IP camera

	DS-2XE6126FWD-HS DS-2XE6146F-HS					
		DS-1696ZJ-X	DS-1697ZJ-X	DS-2780ZJ-X/316L	DS-2781ZJ-X/316L	DS-1677ZJ-XS-1.0 (D)
		Pendant mount - 316L	Wall mount - 316L	Explosion-proof terminal box	Explosion-proof terminal box	Flexible conduit
		Natural stainless steel color Stainless steel 316L φ136 × 306 mm Approx. 1.07 kg	Natural stainless steel color Stainless steel 316L 136*204.3 × 353.4 mm Approx. 1.04 kg	stainless steel Stainless steel 316L 272 mm × 272 mm × 96.8 mm 6.4 kg	Natural stainless steel color Stainless steel 316L 272 mm × 272 mm × 96.8 mm (10.7" × 10.7" × 3.8") Approx. 6.7 kg (14.8 lb.)	NBR, braided steel wire, Carbon steel Ø25 mm × 1000 mm









Recommended brackets for Hikvision IP camera				
	iDS-2CD6810F/C			
		DS-1227ZJ-P1	DS-2102ZJ	DS-1299ZJ
		In-ceiling mount	Wall mount	Pendant mount
		Hik white Metal plate & Plastic Ø 253.4 mm × 38.4 mm (Ø 9.97" × 1.51") 460 g (1.01 lb.)	Hik white Steel 194 mm × 110 mm × 50 mm (7.64" × 4.33" × 1.97") 234 g (0.52 lb.)	Hik white Aluminum alloy 77 × 77 × 198 mm 165 g

Recommended brackets for Hikvision IP camera		
	iDS-2CD6810F-IV/C	
		DS-1275ZJ-P1
		Horizontal pole mount
		Platinum gray Stainless steel, and Steel 127 mm × 140.48 mm × 250 mm (5" × 5.53" × 9.84") 1500 g (3.3 lb.)











Recommended brackets for Hikvision IP camera					
	DS-2CD682560/C-IV(S)				
		DS-1297ZJ	DS-1299ZJ	DS-1297ZJ-ES	DS-1297ZJ-M
		Pendant mount (extendable)	Pendant Mount	Pendant mount (extendable)	Pendant mount (extendable)
	DS-2CD682560/C-IV(S)				
		Hikvision White Aluminum Alloy Ø120×200mm 1035 g (2.28 lb.) 1.2 m to 2.0 m	Hik white Aluminum Alloy 77×77×198mm 165g	Hikvision White Aluminum Alloy Ø 97 mm × 270 mm to 400 mm (Ø 3.82" ×10.63" to 15.75") 500 g (1.10 lb.)	Hikvision White Aluminum Alloy Ø 120 mm × 650 mm to 1200 mm (Ø 4.72" × 25.59" to 47.24") 800 g (1.76 lb.)

Recommended brackets for Hikvision IP camera			
	DS-2CD6054G1-IZ(S)		
		DS-1618ZJ-6D	DS-1661ZJ-6D
		Wall Mount	Pendant Mount
		Hikvision White Aluminum alloy, stainless steel, and silicone rubber 283.5 mm × 250 mm × 165.5 mm (11.16" × 9.84" × 6.52") Approx. 1356 g (2.99 lb.)	Hikvision White Aluminum alloy, stainless steel, and silicone rubber Ø 250 mm × 247 mm (Ø 9.84" × 9.72") Approx. 1338 g (2.95 lb.)













Recommended brackets for Hikvision IP camera

	<p>DS-2CD6D24FWD -(I Z H S I /NFC)</p> <p>DS-2CD6D54FWD -(I Z H S I /NFC)</p>				
		DS-1604ZJ	DS-1663ZJ	DS-1662ZJ	DS-1661ZJ
		Wall mount with junction box	Ceiling mount	Pendant mount	Pendant mount
		Hik white Aluminum alloy 255 × 171 × 355.5 mm 2150 g	Hik white Aluminum alloy Ø116.5 × 57 mm	Hik white Aluminum alloy Ø116.5 × 500 mm 960 g	Hik white Aluminum alloy Ø116.5 × 200 mm 600 g
					
		DS-1604ZJ-pole	DS-1604ZJ-corner	DS-1673ZJ	DS-1602ZJ
		Vertical pole mount	Corner mount	Horizontal pole mount	Wall mount
		Hik white Aluminum alloy 170.7 × 261.8 × 355.5 mm	Hik white Aluminum alloy 206.8 × 261.8 × 465 mm	Hik white Steel(mounting board) & Stainless steel(clamp) Diameter of clamp: Ø67-127 mm Match up with pendant mount	Hik white Aluminum alloy 97 X 182 X 305 mm













Recommended brackets for Hikvision IP camera

	<p>DS-2CD6984G0-IH(S)(AC) DS-2CD6924G0-IH(S)(NFC) DS-2CD6924G0-IH(S)(NFC) DS-2CD6984G0-IH(S)(NFC)</p>					
		DS-1661ZJ	DS-1662ZJ	DS-1663ZJ	DS-1604ZJ	DS-1604ZJ-pole
		Pendant mount	Pendant mount	Ceiling mount	Wall mount with junction box	Vertical pole mount
		Hik white Aluminum alloy Ø116.5 × 200 mm 600 g	Hik white Aluminum alloy Ø116.5 × 500 mm 960 g	Hik white Aluminum alloy Ø116.5 × 57 mm	Hik white Aluminum alloy 255 × 171 × 355.5 mm 2150 g	Hik white Aluminum alloy 170.7 × 261.8 × 355.5 mm
						
		DS-1604ZJ-corner	DS-1604ZJ-box	DS-1604ZJ-BOX-POLE	DS-1604ZJ-BOX-CORNER	DS-1602ZJ
		Corner mount	Wall mount with junction box	Vertical pole mount with junction box	Wall mount with junction box	Wall mount
		Hik white Aluminum alloy 206.8 × 261.8 × 465 mm	Hik white Aluminum alloy 281.2 × 170.7 × 395.5 mm	Hik white Aluminum alloy & steel 222 × 139.3 × 422 mm	Hik white Aluminum alloy & steel 255.5 × 314 × 542.5 mm	Hik white Aluminum alloy 97 X 182 X 305 mm









Recommended brackets for Hikvision PTZ Dome Camera

Outdoor(only available for outdoor PTZ model)			
 	DS-2DF5232X-AEL DS-2DF5225X-AEL		
	DS-2DF7232IX-AEL DS-2DF7232IX-AELW DS-2DF7225IX-AEL DS-2DF7225IX-AELW	DS-1661ZJ Pendant mount	DS-1662ZJ Pendant mount
 	DS-2DE7530IW-AE DS-2DE7430IW-AE DS-2DE7425IW-AE DS-2DE7330IW-AE DS-2DE7320IW-AE DS-2DE7232IW-AE DS-2DE7225IW-AE	Hik white Aluminum alloy Φ116.5 × 200mm 600 g	Hik white Aluminum alloy Φ116.5 × 500 mm 960 g
	DS-2DE7A225MX-AE DS-2DE7A232MX-AE	DS-2DE7A245IX-AE/S1	Hik white Aluminum alloy Φ116.5 × 57 mm 380 g
 	DS-2DF6225X-AEL		
	DS-2DF8836IX-AEL DS-2DF8836IX-AELW DS-2DF8825IX-AEL DS-2DF8825IX-AELW DS-2DF8436IX-AEL DS-2DF8436IX-AELW DS-2DF8425IX-AEL DS-2DF8425IX-AELW DS-2DF8236IX-AEL DS-2DF8236IX-AELW DS-2DF8225IX-AEL DS-2DF8225IX-AELW DS-2DF8250ISX-AEL(W) DS-2DF8242IX-AEL(W) DS-2DF8442IXS-AEL(W)	DS-1660ZJ Parapet wall mount	DS-1604ZJ Wall mount
 	iDS-2VS235-F836	Hik white Aluminum alloy 180 × 950 × 800 mm 2900 g	Hik white Aluminum alloy 255 × 171 × 355.5 mm 2150 g
	DS-2DF8836ISX-AEL(W) DS-2DF8436ISX-AEL(W) DS-2DF8236ISX-AEL(W) DS-2DF8250ISX-AEL(W) DS-2DF8242ISX-AEL(W)	Hik white Aluminum alloy 170.7 × 261.8 × 355.5 mm	Hik white Aluminum alloy 170.7 × 261.8 × 355.5 mm











Recommended brackets for Hikvision PTZ Dome Camera

Outdoor(only available for outdoor PTZ model)					
	DS-2DF5232X-AEL DS-2DF5225X-AEL				
	DS-2DF7232IX-AEL DS-2DF7232IX-AELW DS-2DF7225IX-AEL DS-2DF7225IX-AELW	DS-1604ZJ-corner	DS-1604ZJ-box	DS-1604ZJ-BOX-POLE	DS-1604ZJ-BOX-CORNER
	DS-2DE7530IW-AE DS-2DE7430IW-AE DS-2DE7425IW-AE DS-2DE7330IW-AE DS-2DE7320IW-AE DS-2DE7232IW-AE DS-2DE7225IW-AE	Corner mount	Wall mount with junction box	Vertical pole mount with junction box	Wall mount with junction box
	DS-2DE7A225MX-AE DS-2DE7A232MX-AE	Hik white Aluminum alloy 206.8 × 261.8 × 465 mm	Hik white Aluminum alloy 281.2 × 170.7 × 395.5 mm	Hik white Aluminum alloy & steel 222 × 139.3 × 422 mm	Hik white Aluminum alloy & steel 255.5 × 314 × 542.5 mm
	DS-2DE7A245IX-AE/S1				
	DS-2DF6225X-AEL				
	DS-2DF8836IX-AEL DS-2DF8836IX-AELW DS-2DF8825IX-AEL DS-2DF8825IX-AELW DS-2DF8436IX-AEL DS-2DF8436IX-AELW DS-2DF8425IX-AEL DS-2DF8425IX-AELW DS-2DF8236IX-AEL DS-2DF8236IX-AELW DS-2DF8225IX-AEL DS-2DF8225IX-AELW DS-2DF8250ISX-AEL(W) DS-2DF8242IX-AEL(W) DS-2DF8442IXS-AEL(W)	DS-1619ZJ	DS-1667ZJ	DS-1602ZJ	
	iDS-2VS235-F836	Gooseneck mount	Extendable pole for pendant mount	Wall mount	
	iDS-2VS235-F836		Hik white Aluminum alloy 455.2 × 130.4 × 841.5 mm	Hik white Galvanized steel pipe 1500-2500 mm	Hik white Aluminum alloy 97 X 182 X 305 mm
	DS-2DF8836ISX-AEL(W) DS-2DF8436ISX-AEL(W) DS-2DF8236ISX-AEL(W) DS-2DF8250ISX-AEL(W) DS-2DF8242ISX-AEL(W)				







Recommended brackets for Hikvision PTZ Dome Camera

		Outdoor					
	DS-2DF8225IH-AEL(W)						
		DS-1604ZJ-P	DS-1663ZJ-P	DS-1660ZJ-P	DS-1661ZJ-P	DS-1667ZJ-P	DS-1682ZJ-P
		Wall mount with junction box	Ceiling mount	Parapet wall mount	Pendant mount	Extendable pole for pendant mount	Extendable pole for pendant mount
	DS-2DF6A836X-AEL DS-2DF6A825X-AEL DS-2DF6A436X-AEL DS-2DF6A425X-AEL DS-2DF6A236X-AEL DS-2DF6A225X-AEL						
	DS-2DF8A425I(N)X-AEL DS-2DF8A436I(N)X-AEL DS-2DF8A825I(N)X-AEL DS-2DF8A836I(N)X-AEL DS-2DF8A442IXS-AEL	Platinum gray Aluminum alloy 255 × 171 × 355.5 mm 2150 g	Platinum gray Aluminum alloy Ø116.5 × 57 mm 380 g	Platinum gray Aluminum alloy 180 × 950 × 800 mm 2900 g	Platinum gray Aluminum alloy Ø116.5 × 200 mm 600 g	Platinum gray Galvanized steel pipe 1500-2500 mm	Platinum gray Aluminum alloy Ø 60 mm × 500 mm (Ø 2.36" × 19.69") 1050 g (2.31 lb.) Match up with pendant mount(DS-1661ZJ-P, DS-1662ZJ-P)





Recommended brackets for Hikvision PTZ Dome Camera

		Outdoor			
	DS-2DF8225IH-AEL(W)				
		Pendant mount	Horizontal pole mount	Vertical pole mount	Corner mount
	DS-2DF6A836X-AEL DS-2DF6A825X-AEL DS-2DF6A436X-AEL DS-2DF6A425X-AEL DS-2DF6A236X-AEL DS-2DF6A225X-AEL	Platinum gray Aluminum alloy Ø116.5 × 500 mm 960 g	Platinum gray Steel(mounting board) & Stainless Steel(clamp) Diameter of clamp: Ø67-127mm Match up with pendant mount	Platinum gray Aluminum alloy 170.7 × 261.8 × 355.5 mm	Platinum gray Aluminum alloy 206.8 × 261.8 × 465 mm
	DS-2DF8A425I(N)X-AEL DS-2DF8A436I(N)X-AEL DS-2DF8A825I(N)X-AEL DS-2DF8A836I(N)X-AEL DS-2DF8A442IXS-AEL				
		Wall mount with junction box	Wall mount with junction box	Vertical pole mount with junction box	
		Platinum gray Aluminum alloy 281.2 × 170.7 × 395.5 mm	Platinum gray Aluminum alloy & steel 255.5 × 314 × 542.5 mm	Platinum gray Aluminum alloy & steel 222 × 139.3 × 422 mm	





Recommended brackets for Hikvision PTZ Dome Camera

		Outdoor				
	DS-2DF9C245IH-DLW DS-2DF9C435IH-DLW DS-2DF9C245IHS-DLW DS-2DF9C435IHS-DLW					
		DS-1603ZJ-P	DS-1668ZJ-P	DS-1668ZJ(20)-P	DS-1603ZJ-Pole-P	DS-1619ZJ-HP2
		Wall mount	Pendant mount	Pendant mount	Vertical pole mount	Gooseneck mount
		Platinum gray Aluminum alloy 364.1 mm × 182.0 mm (14.3" × 7.2") 1400 g (3.09 lb.)	Platinum gray Steel Ø115 × 58 mm 620 g	Platinum gray Steel Ø 115 mm × 200 mm (4.53" × 7.87") 1150 g (2.54 lb.)	Platinum gray Aluminum alloy+steel 410.6 × 194 × 126.1 mm 2.5 kg	Platinum gray Stainless steel Ø 130 mm × 455 mm × 526 mm (5.12" × 17.91" × 20.71") 5200 g (12.46 lb.)









Recommended brackets for Hikvision PTZ Dome Camera

		Outdoor			
	DS-2DF5220S-D4 DS-2DF5220S-DE4/W				
		DS-1691ZJ	DS-1695ZJ	DS-1691ZJ-L	DS-1691ZJ-M
		Pendant mount	Integrated wall mount	Pendant mount	Pendant mount
		Hik white Aluminum alloy 84 × 124 × 335 mm 980 g	Hik white Aluminum alloy + Plastic 157 × 86 × 246 mm	Hik white Steel 124 × 84 × 1000 mm 2175 g	Hik white Steel 124 × 84 × 500 mm 1175 g









Recommended brackets for Hikvision PTZ Dome Camera

		Outdoor		
	iDS-2PT9122IX-D/S Wall mount bracket included in the package			
		DS-2664ZJ-P	DS-2601ZJ-P	DS-2665ZJ-P
		Pendent mount	Wall mounting racket	Base mounting bracket
		Grey Aluminum alloy Ø203.5 × 217.4 mm	Plastic with surface spray treatment Ø 203.5 mm × 227.9 mm (Included in the package)	Plastic with surface spray treatment 178.7 mm × 126 mm × 57.2 mm









Recommended brackets for Hikvision PTZ Dome Camera



		Outdoor					
 	DS-2DP1636ZIX-D/236 DS-2DP1636ZIX-D/236(B) DS-2DP0818ZIX-D/236(B) DS-2DP2427ZIXS-DE/436/T4 DS-2DP1618ZIXS-DE/436/T4 DS-2DP1618ZIXS-DE/440/T2 DS-2DP2427ZIXS-DE/440/T2 DS-2DP3236ZIXS-D/440/T2 DS-2DP6436ZIXS-D/836/T2						
		DS-1603ZJ-P	DS-1668ZJ-P	DS-1668ZJ(20)-P	DS-1603ZJ-Pole-P	DS-1619ZJ-HP2	DS-1603ZJ-Corner-P
		Wall mount	Pendant mount	Pendant mount	Vertical pole mount	Gooseneck mount	Corner mount
		Platinum gray Aluminum alloy 364.1 mm × 182.0 mm (14.3" × 7.2") 1400 g (3.09 lb.)	Platinum gray Steel Ø115 × 58 mm 620 g	Platinum gray Steel Ø 115 mm × 200 mm (4.53" × 7.87") 1150 g (2.54 lb.)	Platinum gray Aluminum alloy+steel 410.6 × 194 × 126.1 mm 2.5 kg	Platinum gray Stainless Steel Ø 130 mm × 455 mm × 526 mm (5.12" × 17.91" × 20.71") 5200 g (12.46 lb.)	Platinum gray Aluminum alloy, and Steel 473.1 mm × 194 mm × 176.1 mm (18.63" × 7.64" × 6.93") 2920 g (6.44 lb.)

Recommended brackets for Hikvision PTZ Dome Camera





		Outdoor			
	DS-2DP0818Z-D DS-2DP1636Z-D				
		DS-1603ZJ	DS-1668ZJ	DS-1668ZJ(20)	DS-1673ZJ
		Wall mount	Pendant mount	Pendant mount	Horizontal pole mount
		Hik white Aluminum alloy 98 × 182 × 362 mm	Hik white Steel ∅115 × 58 mm 620 g	Hik white Steel ∅115 × 200 mm 1150 g	Hik white Steel(mounting board) & Stainless steel(clamp) Diameter of clamp: ∅67-127 mm 1060 g (2.34 lb.) Match up with pendant mount
					
		DS-1684ZJ	DS-1678ZJ	DS-1619ZJ-H2	
Vertical pole mount	Junction box	Gooseneck mount			
Hik white Steel(mounting board) & Stainless steel(clamp) Diameter of clamp: ∅67-127 mm Match up with wall mount	Hik white Aluminum alloy 286 × 424 × 119.5 mm	Hik white Stainless steel ∅ 130 mm × 455 mm × 526 mm (5.12" × 17.91" × 20.71") 5200 g (12.46 lb.)			

Recommended brackets for Hikvision PTZ Dome Camera





		Outdoor			
	DS-2DP1636-D				
		DS-1603ZJ	DS-2663ZJ	DS-1668ZJ	DS-1668ZJ(20)
		Wall mount	3-axis mount	Pendant mount	Pendant mount
		Hik white Aluminum alloy 98 × 182 × 362 mm	Hik white Aluminum alloy 275.8 × 269 × 140.1 mm 2600 g	Hik white Steel Ø115 × 58 mm 620 g	Hik white Steel Ø115 × 200 mm 1150 g
					
		DS-1673ZJ	DS-1684ZJ	DS-1678ZJ	DS-1619ZJ-H2
Horizontal pole mount	Vertical pole mount	Junction box	Gooseneck mount		
Hik white Steel(mounting board) & Stainless steel(clamp) Diameter of clamp: Ø67-127 mm Match up with pendant mount	Hik white Steel(mounting board) & Stainless steel(clamp) Diameter of clamp: Ø67-127 mm Match up with Wall mount	Hik white Aluminum alloy 286 × 424 × 119.5 mm	Hik white Stainless steel Ø 130 mm × 455 mm × 526 mm (5.12" × 17.91" × 20.71") 5200 g (12.46 lb.)		

Recommended brackets for Hikvision PTZ Dome Camera			
	DS-2DT6223-AELY DS-2DT6223W-AELY	Outdoor	
			
		DS-1696ZJ-Y	DS-1697ZJ-Y
Pendant mount	Wall mount		
Stainless steel 316L 160 × 160 × 342 mm 1890 g	Stainless steel 316L 136 × 212 × 326 mm 2300 g		



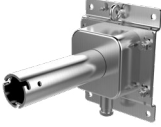



Recommended brackets for Hikvision PTZ Dome Camera				
	DS-2DF8236IX-AELWY	Outdoor		
				
		DS-1602ZJ-AKS	DS-1604ZJ-BOX-Corner-Y	DS-1604ZJ-BOX-Y
Wall mount	Corner pole mount with junction box	Wall mount with junction box		
Hik white Alloy 97.3 mm × 182.6 mm × 306.4 mm (3.83" × 7.19" × 12.06") 960 g (2.12 lb.)	Hik white Alloy, SUS304 314 mm × 25.5 mm × 542.5 mm (12.36" × 10.06" × 21.36") 6976 g (15.38 lb.)	Hik white Alloy 281.2 mm × 170.7 mm × 395.5 mm (11.07" × 6.72" × 15.57") 2150 g (4.74 lb.)		

Recommended brackets for Hikvision PTZ Dome Camera					
	DS-2DF6223-CX(W) Wall mount bracket included in the package	Outdoor			
					
		DS-1691ZJ-X	DS-1690ZJ-X	DS-1677ZJ-XS-1.0 (C2)	DS-2780ZJ-X
Pendant mounting	Wall mounting bracket	Flexible conduit	Explosion-proof terminal box		
Stainless steel 304L 250 mm × 200 mm × 303 mm 6 kg	1 SUS304 stainless steel 350 mm × 227.5 mm × 345.5 mm 7 kg (Included in the package)	NBR, braided steel wire, carbon steel Ø25 mm × 1000 mm	stainless steel 272 mm × 272 mm × 96.8 mm 6.4 kg		

Recommended brackets for Hikvision PTZ Dome Camera

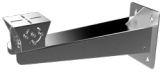
		Outdoor			
	DS-2DF6223-CX(W/316L) Wall mount bracket included in the package				
		DS-1693ZJ-X	DS-1692ZJ-X	DS-1677ZJ-XS-1.0 (C2)	DS-2780ZJ-X/316L
		Pendant mounting	Wall mounting bracket	Flexible conduit	Explosion-proof terminal box
		Stainless steel 316L 250 mm × 200 mm × 303 mm 6 kg	SUS316L 350 mm × 200 mm × 345 mm 7 kg (Included in the package)	NBR, braided steel wire, carbon steel Ø25 mm × 1000 mm	Stainless steel 272 mm × 272 mm × 96.8 mm 6.4 kg

Recommended brackets for Hikvision PTZ Dome Camera





		Outdoor					
	DS-2DB4223I-CX(W/E)						
		DS-1707ZJ	DS-1707ZJ-E	DS-2780ZJ-X	DS-1708ZJ	DS-1677ZJ-XS-1.0 (D)	DS-1751ZJ
		Wall mount (304 stainless steel)	Wall mount (304 stainless steel)	Explosion-proof terminal box	PT joint	Flexible conduit	Vertical pole mount
		-	-	stainless steel 272 mm × 272 mm × 96.8 mm 6.4 kg	-	NBR, braided steel wire, carbon steel Ø25 mm × 1000 mm	-





Recommended brackets for Hikvision PTZ Dome Camera					
	DS-2DB4223I-CX(WE/316L) DS-2DB4236I-CWX(WE/316L)	Outdoor			
					
		DS-1707ZJ-Y	DS-1707ZJ-Y-E	DS-2780ZJ-X/316L	DS-1677ZJ-XS-1.0 (D)
Wall mount (316L stainless steel)	Wall mount (316L stainless steel)	Explosion-proof terminal box	Flexible conduit		
Unpainted stainless steel SUS316L 562.5 mm × 180 mm × 309 mm (22.15" × 7.09" × 12.17") 7.02 kg (15.48 lb.)	Unpainted stainless steel SUS316L 543.5 mm × 160 mm × 258 mm (21.40" × 6.30" × 10.16") 4.98 kg (10.98 lb.)	Stainless steel 272 mm × 272 mm × 96.8 mm 6.4 kg	NBR, braided steel wire, carbon steel Ø25 mm × 1000 mm		



Recommended brackets for Hikvision PTZ Dome Camera

DS-1662ZJ
Extendable pole for pendant mount
Hik white Aluminum alloy 500 mm Match up with pendant mount (DS-1661ZJ). DS-1662ZJ)



Recommended brackets for Hikvision PTZ Dome Camera

DS-1673ZJ
Horizontal pole mount
Hik white Steel (mounting board) & Stainless steel (clamp) Diameter of clamp: Ø67-127 mm Match up with pendant mount



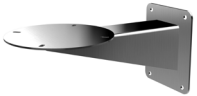

Positioning System





Product form	Model	Relevant brackets and housings---Outdoor	
	DS-2DY9250IAX-A DS-2DY9236I8X-A DS-2DY9250IAX-A(S1)		
	DS-2DY9250IAX-A(S1) DS-2DY9250IAX-A(S1)	DS-1693ZJ	DS-1678ZJ
	DS-2DY9225IH-A DS-2DY9250IX-A DS-2DY9236IX-A DS-2DY9250IX-A(S1)	Wall mount	Junction box
	DS-2DY9250IX-A DS-2DY9236W-A DS-2DY9236IW-A	Hik white Steel 190 × 200 × 500 mm 5700 g	Hik white Aluminum alloy 286 × 424 × 119.5 mm

Product form	Model	Relevant brackets and housings---Outdoor		
	DS-2DY3320IW-DE DS-2DY3220IW-DE			
		DS-1280ZJ-M(SPTZ)	DS-1281ZJ-M(SPTZ)	DS-1275ZJ(SPTZ)
		Junction box	Inclined ceiling mount	Pole mount
		Hik white Steel 157 x 53.4 x 184 mm 621 g	Hik white Steel 157 x 61.8 x 165.7 mm 586 g	Hik white Steel 250 x 127 x 140 mm















Product form	Model	Outdoor
	DS-2DY3320IW-DE4 DS-2DY3220IW-DE4	
		DS-1275ZJ(SPTZ)
		Pole mount
		Hik white Steel 250 x 127 x 140 mm





Product form	Model	Relevant brackets and housings---Outdoor		
	DS-2DY9236I-CWX(W/316L) Wall mount bracket included in the package			
		DS-1713ZJ-Y(SUS316L)	DS-2780ZJ-X/316L	DS-1677ZJ-XS-1.0 (D)
		Wall mounting bracket	Explosion-proof terminal box	Flexible conduit
		Natural stainless steel color SUS316L Ø 270 mm × 479 mm × 235 mm (Ø 10.63" × 18.86" × 9.25") 7.1 kg (15.65 lb.) (Included in the package)	Stainless steel 272 mm × 272 mm × 96.8 mm 6.4 kg	NBR, braided steel wire, carbon steel Ø25 mm × 1000 mm



Indoor housing						
Appearance	Model	Key Feature	Available Camera Models	Bracket Model		
	DS-1330HZ	Hik white Complex fiber 290×142×92 mm 640 g	DS-2CD4C16FWD-(A)(P) DS-2CD4C26FWD-(A)(P) DS-2CD4C36FWD-(A)(P) DS-2CD4026FWD-A/P DS-2CD5026G0-(AP) DS-2CD5046G0-(AP) DS-2CD5065G0-(AP) DS-2CD5085G0-(AP) DS-2CD50C5G0-(AP) DS-2CD7026G0/(P)-(AP) DS-2CD7046G0-(AP) DS-2CD7085G0-(AP)			
				DS-1293ZJ	DS-1299ZJ	DS-1269ZJ
				Wall mount	Pendant mount	Pendant mount
				Hik white Aluminum alloy 88 × 116.6 × 297.3 mm 473 g	Hik white Aluminum Alloy 77 × 77 × 198 mm 165 g	Hik white Aluminum alloy 493 × 246 × 88 mm 480 g











Indoor housing						
Appearance	Model	Key Feature	Available Camera Models	Bracket Model		
	DS-1332HZ	Hik white Aluminum alloy 288 × 149 × 100 mm 800 g	DS-2CD4C16FWD-(A)(P) DS-2CD4C26FWD-(A)(P) DS-2CD4C36FWD-(A)(P) DS-2CD4026FWD-A/P DS-2CD5026G0-(AP) DS-2CD5046G0-(AP) DS-2CD5065G0-(AP) DS-2CD5085G0-(AP) DS-2CD50C5G0-(AP) DS-2CD7026G0/(P)-(AP) DS-2CD7046G0-(AP) DS-2CD7085G0-(AP)			
				DS-1293ZJ	DS-1299ZJ	DS-1269ZJ
				Wall mount	Pendant mount	Pendant mount
				Hik white Aluminum alloy 88 × 116.6 × 297.3 mm 473 g	Hik white Aluminum Alloy 77 × 77 × 198 mm 165 g	Hik white Aluminum alloy 493 × 246 × 88 mm 480 g

Indoor housing







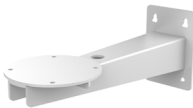

Appearance	Model	Key Feature	Available Camera Models	Bracket Model				
	DS-1331HZ-C	Hik white Aluminum alloy Containing fan DC12V IP66 110 × 165 × 445 mm 1900 g						
	DS-1331HZ-H	Hik white Aluminum alloy Containing fan and heater AC24V IP66 110 × 165 × 445 mm 1900 g		DS-1293ZJ	DS-1269ZJ	DS-1214ZJ	DS-1214ZJ-T	DS-1233ZJ
				Wall mount	Pendant mount	Horizontal pole mount	Horizontal pole mount	Column mount
	DS-1331HZ-HW	Hik white Aluminum alloy Containing fan, wiper and heater AC24V IP66 445 × 165 × 170 mm 2500 g	DS-2CD4C16FWD-[A]IP DS-2CD4C26FWD-[A]IP DS-2CD4C36FWD-[A]IP DS-2CD4Q26FWD-A/P DS-2CD5Q26G0-[AP] DS-2CD5Q46G0-[AP] DS-2CD5Q65G0-[AP] DS-2CD5Q85G0-[AP] DS-2CD5QC5G0-[AP] DS-2CD7Q26G0/(P)-[AP] DS-2CD7Q46G0-[AP] DS-2CD7Q85G0-[AP]	Hik white Aluminum alloy 88 × 116.6 × 297.3 mm 473 g	Hik white Aluminum alloy 493 × 246 × 88 mm 480 g	Hik white Steel (mounting board) & Stainless Steel (clamp) 117 × 226 × 194mm Diameter of clamp: Ø67-127 mm 1895 g	Hik white Steel (mounting board) & Stainless Steel (clamp)	Hik white Steel Ø160 × 1093 mm 6200 g
	DS-1331HZ-CI	Hik white Aluminum alloy Containing fan DC12V IP66 IK10 445 × 140 × 94 mm 1900 g						
	DS-1331HZ-HI	Hik white Aluminum alloy Containing fan and heater AC 24V(DC 12V) IP66 IK10 110 × 165 × 445mm 1900 g		DS-1232ZJ	DS-1232ZJ-T	DS-1275ZJ-SUS	DS-2204ZJ	
	DS-1331HZ-R	Hik white Aluminum alloy Containing Cooling module AC 110 to 240V IP66 490 × 169.4 × 100 mm 3200 g		Hik white Steel 126 × 103.5 × 83 mm 790	Hik white Steel 96 × 95 × 92.5 mm	Hik white Stainless Steel 127 × 46 × 250 mm Diameter of clamp: Ø67-127 mm 1205 g Match up with wall mount (DS-1293ZJ)	Hik white Aluminum alloy 413.5 × 228.7 × 120 mm 1859 g	





Outdoor housing								
Appearance	Model	Key Feature	Available Camera Models	Bracket Model				
	DS-4718HZ-K	Hik white Aluminum alloy Containing fan and heater AC 24V(DC 12V) IP66 174 × 153 × 550 mm 2500 g	DS-2CD4C16FWD-(A)(P) DS-2CD4C26FWD-(A)(P) DS-2CD4C36FWD-(A)(P) DS-2CD4026FWD-A/P DS-2CD5026G0-(AP) DS-2CD5046G0-(AP) DS-2CD5065G0-(AP) DS-2CD5085G0-(AP) DS-2CD50C5G0-(AP) DS-2CD7026G0(/P)-(AP) DS-2CD7046G0-(AP) DS-2CD7085G0-(AP)					
				DS-1293ZJ	DS-1269ZJ	DS-1214ZJ	DS-1214ZJ-T	DS-1275ZJ-SUS
				Wall mount	Pendant mount	Horizontal pole mount	Horizontal pole mount	Vertical pole mount
			Hik white Aluminum alloy 88 × 116.6 × 297.3 mm 473 g	Hik white Aluminum alloy 88 × 116.6 × 297.3 mm 473 g Hik white Aluminum alloy 493 × 246 × 88 mm 480 g	Hik white Steel (mounting board) & Stainless Steel (clamp) 117 × 226 × 194 mm Diameter of clamp: Ø67- 127 mm 1895 g	Hik white Steel (mounting board) & Stainless Steel (clamp)	Hik white Stainless Steel 127 × 46 × 250 mm	Diameter of clamp: Ø67-127 mm 1205 g Match up with wall mount [DS- 1293ZJ]



Outdoor housing				
Appearance	Model	Key Feature	Available Camera Models	Bracket Model
	DS-1340HZ	Three-axis adjustment Containing combined wires and fan IK10	DS-2CD4C16FWD-(A)(P) DS-2CD4C26FWD-(A)(P) DS-2CD4C36FWD-(A)(P) DS-2CD4026FWD-A/P DS-2CD5026G0-(AP) DS-2CD5046G0-(AP) DS-2CD5065G0-(AP) DS-2CD5085G0-(AP) DS-2CD50C5G0-(AP) DS-2CD7026G0(/P)-(AP) DS-2CD7046G0-(AP) DS-2CD7085G0-(AP)	
				DS-1275ZJ-4626
				Vertical pole mount
				Hik white
				Steel (mounting board) & Stainless Steel (clamp) 127 × 46 × 250 mm 1235 g For 40 series box camera

Product form	Model	Recommended brackets for Hikvision Thermal Camera			
		Relevant brackets			
 	DS-2TD4137 DS-2TD4137T DS-2TD4167 DS-2TD4167T				
		DS-1604ZJ-pole	DS-1604ZJ-corner	DS-1604ZJ-box	DS-1604ZJ-BOX-POLE
		Vertical pole mount	Corner mount	Wall mount, including power box	Vertical pole mount with junction box
		Hik white Aluminum alloy 170.7 × 261.8 × 355.5 mm	Hik white Aluminum alloy 206.8 × 261.8 × 465 mm	Hik white Aluminum alloy 281.2 × 170.7 × 395.5 mm	Hik white Aluminum alloy & steel 222 × 139.3 × 422 mm
	DS-2TD4237/V2				
		DS-1604ZJ-BOX-CORNER	DS-1619ZJ	DS-1602ZJ	DS-1673ZJ
Wall mount with junction box		Gooseneck mount	Wall mount	horizontal pole mount	
		Hik white Aluminum alloy & steel 255.5 × 314 × 542.5 mm	Hik white Aluminum alloy 455.2 × 130.4 × 841.5 mm	Hik white Aluminum alloy 97×182×305 mm	Hik white Steel (mounting board) & Stainless Steel (clamp) Diameter of clamp: Ø67-127 mm Match up with DS-1661ZJ or DS-1662ZJ or DS-1663ZJ





Product form	Model	Recommended brackets for Hikvision Thermal Camera	
		Relevant brackets	
	DS-2TD6267-W DS-2TD6267T-W		
		DS-1693ZJ	
		Wall mount	
		Hik white Steel 190 x 200 x 500 mm 5700 g	





Product form	Model	Recommended brackets for Hikvision Thermal Camera					
		Relevant brackets					
	DS-2TD1217/PA						
		DS-1273ZJ-140	DS-1275ZJ-SUS	DS-1276ZJ-SUS	DS-1273ZJ-140B	DS-1271ZJ-140	DS-1280ZJ-DM21
	DS-2TD1117/PA	Wall mount	Vertical pole mount	Corner mount	Wall mount	Pendant Mount	Junction box
		Hik white Aluminum alloy 140×183.5×232mm 703g	Hik white Stainless Steel 127×46×250mm Diameter of clamp: Ø67-127mm 1480g Match up with wall mount(DS-1273ZJ-XX(B))	Hik white Stainless Steel 126X105X250mm 2280g Match up with wall mount(DS-1273ZJ-XX(B))	Hik white Aluminum alloy with junction box 140×243×292mm 1488g	Hik white Aluminum alloy Ø150×565mm 1900g	Hik white Aluminum alloy 162×137×42mm 250g





Product form	Model	Recommended brackets for Hikvision Thermal Camera		
		Relevant brackets		
	DS-2TD2617/PA	 DS-1275ZJ-SUS	 DS-1276ZJ-SUS	 DS-1260ZJ (shipped by default)
	DS-2TD2637/P DS-2TD2667/P			
	DS-2TD2117/PA	Hik white Stainless Steel 127×46×250mm Diameter of clamp: Ø67-127mm 1480g Match up with wall mount(DS-1273ZJ-XX(B))	Hik white Stainless steel 126 X 105 X 250 mm 2280 g	Hik white Aluminum alloy Ø 88.5 mm × 36 mm (Ø 3.48" × 1.42") 251 g
	DS-2TD2137/P DS-2TD2167/P			









Product form	Model	Recommended brackets for Hikvision Thermal Camera
		Relevant brackets
	DS-2TD2137/PY DS-2TD2167/PY	 DS-1275ZJ-Y Pole mount Anti-corrosion Hik white Stainless Steel 127×250×Ø167mm











Product form	Model	Recommended brackets for Hikvision Thermal Camera
		Relevant brackets
	DS-2TD2367/P	 DS-2904ZJ Vertical pole mount Hik white Steel 157 × 240 × Ø200 mm







Product form	Model	Recommended brackets for Hikvision Thermal Camera			
		Relevant brackets			
	DS-2TX3742-A/P	 DS-2902ZJ (shipped by default with 'A') Wall mount	 DS-2904ZJ Vertical pole mount	 DS-2903ZJ (shipped by default with 'P') Horizontal pole mount	 DS-2905ZJ (shipped by default with 'P') Vertical pole mount
	DS-2TX3742-P/P				





Product form	Model	Recommended brackets for Hikvision Thermal Camera			
		Relevant brackets			
	DS-2TD2466T-X				
		DS-1707ZJ-Y	DS-2780ZJ-X/316L	DS-1677ZJ-XS-1.0 (D)	DS-1751ZJ
		[shipped by default]			
		Wall mount (316L stainless steel)	Explosion-proof terminal box	Flexible conduit	Vertical pole mount
		Unpainted stainless steel SUS316L 562.5 mm × 180 mm × 309 mm (22.15" × 7.09" × 12.17") 7.02 kg (15.48 lb.)	Stainless steel 272 mm × 272 mm × 96.8 mm 6.4 kg	NBR, braided steel wire, carbon steel Ø25 mm × 1000 mm	Stainless steel 221 × 350 × Ø200 mm

Product form	Model	Recommended brackets for Hikvision Thermal Camera		
		Relevant brackets		
	DS-2TD3017T			
		DS-1299ZJ	DS-1297ZJ-ES	DS-2920ZJ
		Wall / Roof mount	Roof mount (Elastic)	Ball hinge bracket
		Hik white Aluminum Alloy 77×77×198mm 165g	Hik White Aluminum Alloy Ø 97 mm × 270 mm to 400 mm (Ø 3.82" × 10.63" to 15.75") 500 g [extendable]	Black Aluminum Alloy Ø 50mm × 56.5 mm 90 g

Product form	Model	Recommended brackets for Hikvision Thermal Camera			
		Relevant brackets			
	DS-2TD1217B/PA				
		DS-1273ZJ-140	DS-1275ZJ-SUS	DS-1276ZJ-SUS	DS-1273ZJ-140B
		Wall mount	Vertical pole mount	Corner mount	Wall mount
		Hik white Aluminum alloy 140×183.5×232mm 703g	Hik white Stainless Steel 127×46×250mm Diameter of clamp: Ø67-127mm 1480g Match up with wall mount[DS-1273ZJ-XX(B)]	Hik white Stainless Steel 126×105×250mm 2280g Match up with wall mount[DS-1273ZJ-XX(B)]	Hik white Aluminum alloy with junction box 140×243×292mm 1488g
					
		DS-1271ZJ-140	DS-1280ZJ-DM21	DS-2908ZJ	DS-2907ZJ
		Pendant Mount	Junction box	Turret-Tripod adapter	Tripod
		Hik white Aluminum alloy Ø150×565mm 1900g	Hik white Aluminum alloy 162×137×42mm 250g	UNC 1/4"-20 Tripod connection	UNC 1/4"-20 Tripod connection

Product form	Model	Recommended brackets for Hikvision Thermal Camera			
		Relevant brackets			
	DS-2TD2617B/PA				
		DS-1260ZJ (shipped by default)	DS-1276ZJ-SUS	DS-2909ZJ	DS-1275ZJ-Y
		Junction box	Corner mount	Bullet-Tripod adapter	Vertical pole mount
		Hik white Aluminum alloy Ø88.5 mm	Hik white Stainless steel 158X173mm	UNC 1/4"-20 Tripod connection	Anti-corrosion Hik white Stainless steel 127×250×Ø167mm (use without junction box)
	DS-2TD2637B/P DS-2TD2636B/P				
		DS-1275ZJ-SUS	DS-1276ZJ-Y	DS-2921ZJ-S	DS-2907ZJ
		Vertical pole mount	Corner mount	Pendant Mount	Tripod
		Hik white Stainless steel 127×250×Ø167mm (use without junction box)	*Anti-corrosion Hik white Stainless steel 126×250×105mm*	Hik white Aluminum alloy Extendible, 0.6m - 1.2m	UNC 1/4"-20 Tripod connection

Product form	Model	Recommended brackets for Hikvision Thermal Camera				
		Relevant brackets				
	DS-2TE127-64A					
		DS-1293ZJ-T	DS-1297ZJ	DS-2921ZJ-S	DS-2921ZJ-M	DS-2922ZJ
		Wall Mount	Pendant mount	Pendant Mount	Pendant Mount	Column Mount
		Hik white Aluminum alloy Ø88.5 mm	Hik white Aluminum alloy Ø120x2000mm 1035 g (2.28 lb.) Extendable Range 1.2 m to 2.0 m	Hik white Aluminum alloy Extendible, 0.6m - 1.2m	Hik white Aluminum alloy Extendible, 1.2m - 2.4m	Hik white Aluminum alloy Extendible, 1.4m - 2.4m

Product form	Model	Recommended brackets for Hikvision Thermal Camera		
		Relevant brackets		
	DS-2TP21B-6AVF/W			
		DS-3750DC	DS-5202ZC	DS-2907ZJ
		Handheld Battery	Charger Base with adapter	Tripod
				UNC 1/4"-20 Tripod connection

Power Adaptor

Power adaptor	Detail	Available Models
DC12V 1A Hikvision Brand	DS-2FA1201-DL,12V/1A,American standard,Φ2.1	Most IPC, analog camera and DS-2DE3/2xxx series mini PTZ models
	DS-2FA1201-DL,12V/1A,European standard,Φ2.1	
	DS-2FA1201-DL,12V/1A,Indian standard,Φ2.1	
DC12V 1A	ADS-12FG-12N 12012EPG,12V/1A,European standard,Two-wire, WHITE PACKAGE	Most IPC, analog camera and DS-2DE3/2xxx series mini PTZ models WHITE PACKAGE model is recommended for selling power adaptor alone, normal model is recommended for selling power adaptor with camera.
	ADS-12FG-12N 12012EPG,12V/1A,European standard,Φ2.1, WHITE PACKAGE	
	ADS-12FG-12N 12012EPCU,12V/1A,American standard,Two-wire, WHITE PACKAGE	
	ADS-12FG-12N 12012EPCU,12V/1A,American standard,Φ2.1, WHITE PACKAGE	
	ADS-12FG-12N 12012EPB,12V/1A,British standard,Two-wire, WHITE PACKAGE	
	ADS-12FG-12N 12012EPB,12V/1A,British standard,Φ2.1, WHITE PACKAGE	
DC12V 1.5A	MSA-C1500IC12.0-18P-US, DC12V/1.5A, American standard plug, Φ2.1	-
	MSA-C1500IC12.0-18P-DE, DC12V/1.5A, European standard plug, Φ2.1	
	MSA-C1500IC12.0-18P-GB, DC12V/1.5A, British standard plug, Φ2.1	
DC12V 2A	ADS-12FG-12N 12012EPCU,12V/1A,American standard,Φ2.1, WHITE PACKAGE	
	ADS-12FG-12N 12012EPB,12V/1A,British standard,Two-wire, WHITE PACKAGE	
	MSA-C2000IC12.0-24P-US,American standard,12V2A,Φ2.1	
Waterproof	DS-2PA1201-WRD, 12 VDC/1 A, Wall Mount	
SMPS	DS-2FA1225-D4(EUR), 4 Channels, 12 VDC/1 A per channel, European standard	
	DS-2FA1225-D4(IND), 4 Channels, 12 VDC/1 A per channel, Indian standard	
	DS-2FA1225-D4(UK), 4 Channels, 12 VDC/1 A per channel, British standard	
	DS-2FA1205-D8(EUR), 8 Channels, 12 VDC/1 A per channel, European standard	
	DS-2FA1205-D8(IND), 8 Channels, 12 VDC/1 A per channel, Indian standard	
	DS-2FA1205-D8(UK), 8 Channels, 12 VDC/1 A per channel, British standard	

Camera tester

-	-	
	IPC-4300H	Network camera tester, 4.3" Screen, with ANSI/EN/BS/AS power supply, Support IP/CVBS/TVI(AHD/CVI) input

Pickup

	DS-2FP2020	Pickup range: 70 sq.m, Audio transmission distance: 3000 m, Frequency response: 20 Hz to 20 KHz, SNR: 60 dB[1m40 dB audio tone SPL] 40 dB (10m 40 dB audio tone SPL) 1 KHz at 1 Pa, Dynamic Range: 70 dB[1 KHz at Max dB SPL]
	DS-2FP4021-B	Pickup Scope: 60 m2 / continuously adjustable, Gain Adjustment Scope: 30 dB/ continuous, Pickup Direction: Full Directions / 360°, Frequency Response: 100 Hz to 16 KHz[1 kHz @ 94 dB SPL], Dynamic Range: 85 dB, Output Impedance: 600 Ohm unbalanced
	DS-2FP2020	Pickup range: 70 sq.m, Audio transmission distance: 3000 m, Frequency response: 20 Hz to 20 KHz, SNR: 60 dB[1m40 dB audio tone SPL] 40 dB (10m 40 dB audio tone SPL) 1 KHz at 1 Pa, Dynamic Range: 70 dB[1 KHz at Max dB SPL]

DORI Distance (D/O/R/I)

NETWORK CAMERA

DeepinView Series

Find the Optimal Camera for Your Individual Security Needs

The DORI distance is a "general proximity" of distance which makes it easy to pinpoint the right camera for your needs. The DORI distance is calculated based on sensor specification and lab test result according to EN 62676-4 which defines the criteria for Detect, Observe, Recognize and Identify respectively.

iDS-2CD8C4660-XZS(11-40/4)
11-40 mm (W)
11-40 mm (T)
4 mm

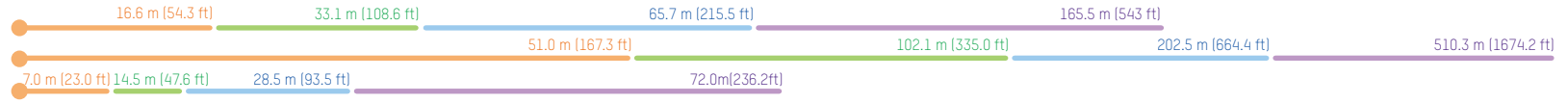

iDS-2CD8C4660P-XZS(10-50/4)
10-50 mm (W)
10-50 mm (T)
4 mm



iDS-7XC560 Series
2.8-12 mm (W)
2.8-12 mm (T)
3.8-16 mm (W)
3.8-16 mm (T)
8-32 mm (W)
8-32 mm (T)
11-40 mm (W)
11-40 mm (T)

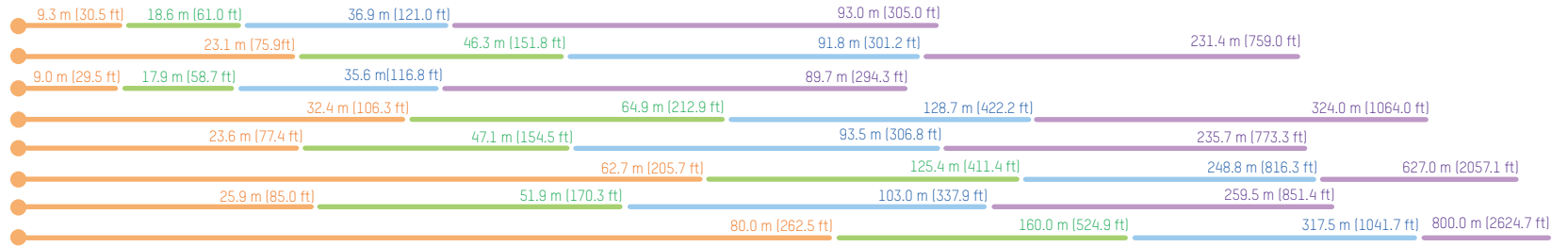

iDS-7X8660 Series
2.8-12 mm (W)
2.8-12 mm (T)
3.8-16 mm (W)
3.8-16 mm (T)
8-32 mm (W)
8-32 mm (T)
11-40 mm (W)
11-40 mm (T)

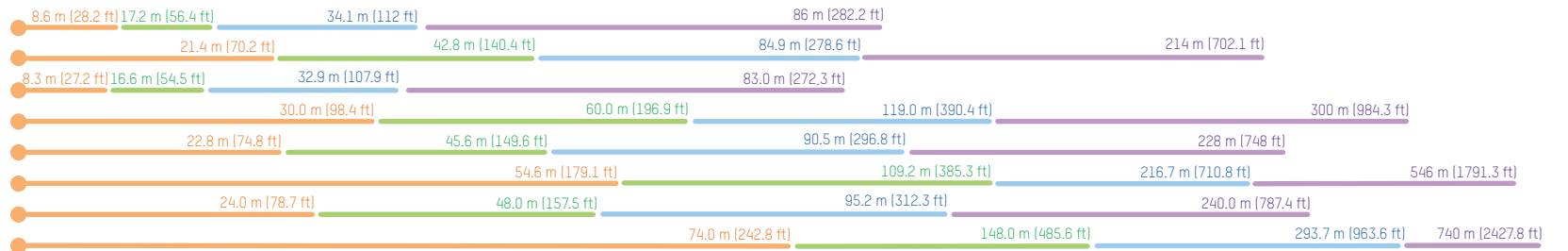

Find the Optimal Camera for Your Individual Security Needs

DORI Distance (D/O/R/I)

- Detect: 25 ppm
- Observe: 63 ppm
- Recognize: 125 ppm
- Identify: 250 ppm

NETWORK CAMERA

DeepinView Series

IDS-7X4660 Series

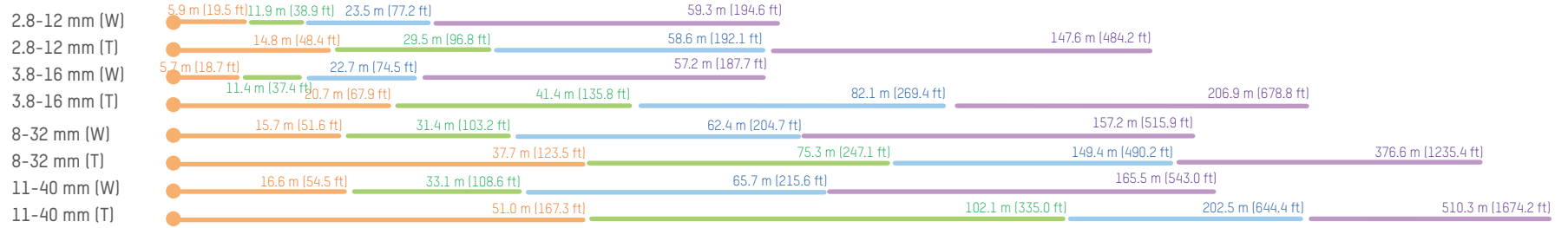

IDS-7X2660 Series

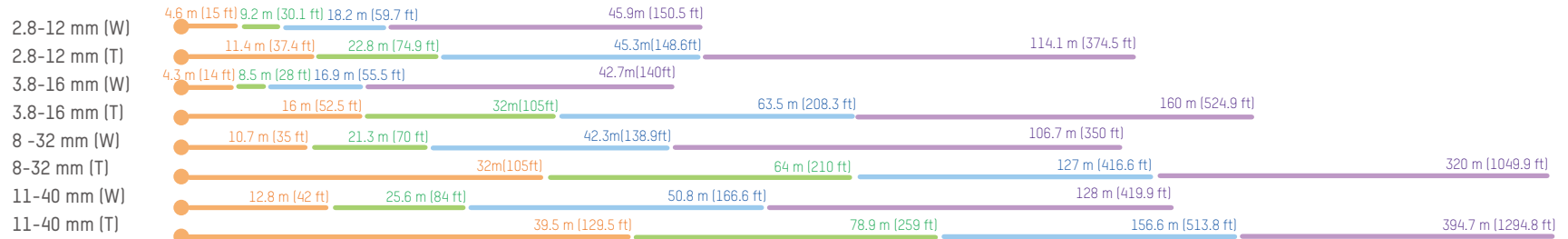

Ultra Series

5XC5 Series



5X85 Series

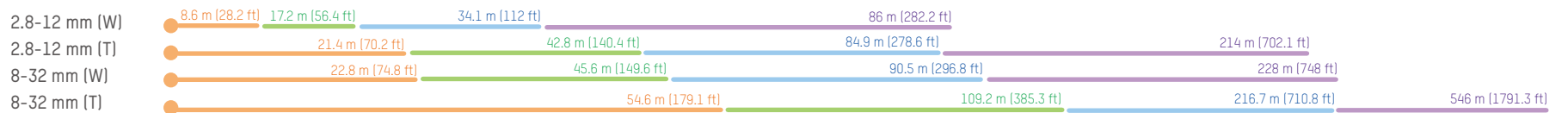

Find the Optimal Camera for Your Individual Security Needs

The DORI distance is a "general proximity" of distance which makes it easy to pinpoint the right camera for your needs. The DORI distance is calculated based on sensor specification and lab test result according to EN 62676-4 which defines the criteria for Detect, Observe, Recognize and Identify respectively.

DORI Distance (D/O/R/I)

- Detect: 25 ppm
- Observe: 63 ppm
- Recognize: 125 ppm
- Identify: 250 ppm

NETWORK CAMERA

Ultra Series



Find the Optimal Camera for Your Individual Security Needs

The DORI distance is a "general proximity" of distance which makes it easy to pinpoint the right camera for your needs. The DORI distance is calculated based on sensor specification and lab test result according to EN 62676-4 which defines the criteria for Detect, Observe, Recognize and Identify respectively.

DORI Distance (D/O/R/I)

- Detect: 25 ppm
- Observe: 63 ppm
- Recognize: 125 ppm
- Identify: 250 ppm

NETWORK CAMERA

Ultra Series

4026/4A26/4626 Series

- 2.8-12 mm (W)
- 2.8-12 mm (T)
- 3.8-16 mm (W)
- 3.8-16 mm (T)
- 7-33 mm (W)
- 7-33 mm (T)
- 8-32 mm (W)
- 8-32 mm (T)
- 11-40 mm (W)
- 11-40 mm (T)

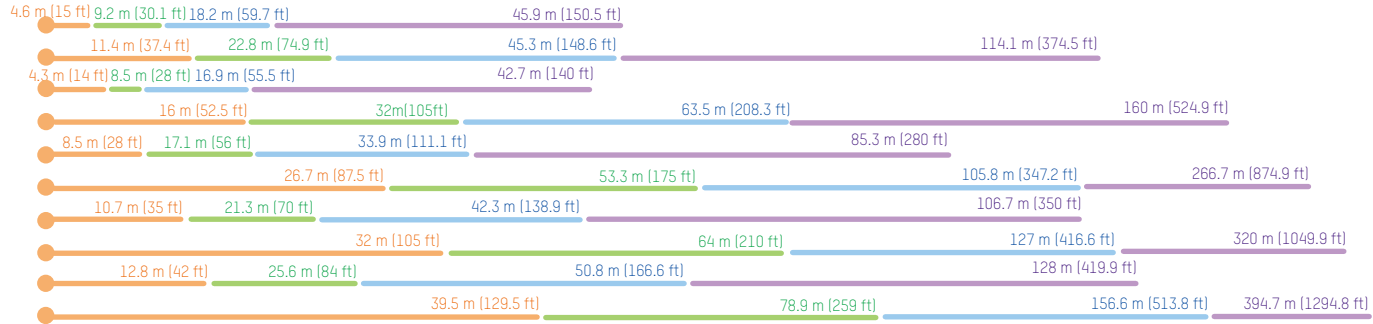

4A45/4B45 Series

- 4.7-65.8 mm (W)
- 4.7-65.8 mm (T)
- 4.7-94 mm (W)
- 4.7-94 mm (T)

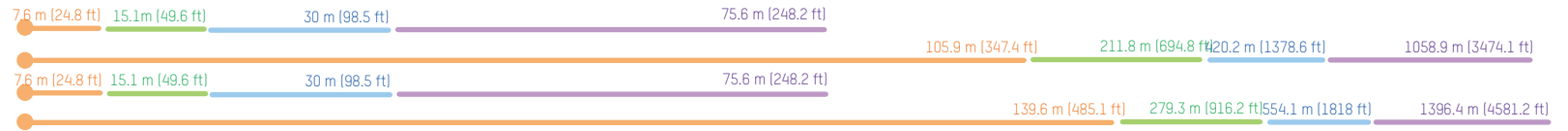

3X85 Series

- 2.8 mm
- 4 mm
- 6 mm
- 2.7-13.5 mm (W)
- 2.7-13.5 mm (T)

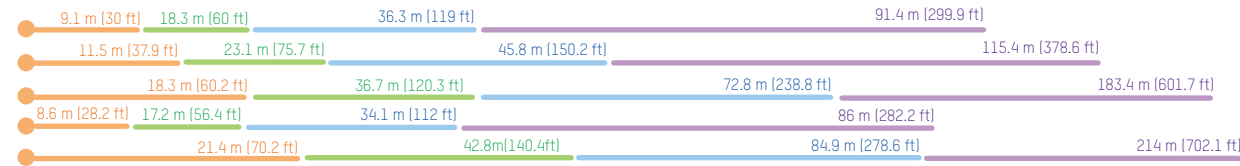

3X63 Series

- 2.8 mm
- 4 mm
- 6 mm
- 2.7-13.5 mm (W)
- 2.7-13.5 mm (T)

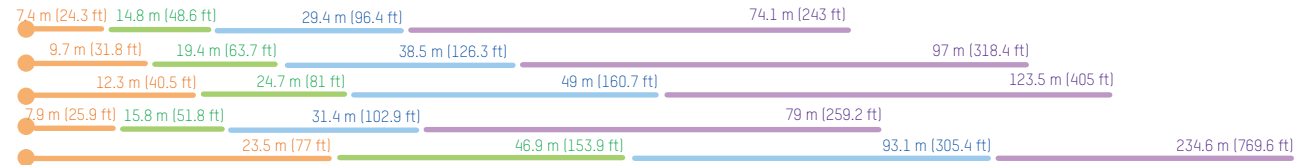

3X55 Series

- 1.05 mm



Find the Optimal Camera for Your Individual Security Needs

The DORI distance is a "general proximity" of distance which makes it easy to pinpoint the right camera for your needs. The DORI distance is calculated based on sensor specification and lab test result according to EN 62676-4 which defines the criteria for Detect, Observe, Recognize and Identify respectively.

NETWORK CAMERA

Ultra Series

DORI Distance (D/O/R/I)

- Detect: 25 ppm
- Observe: 63 ppm
- Recognize: 125 ppm
- Identify: 250 ppm



Find the Optimal Camera for Your Individual Security Needs

The DORI distance is a "general proximity" of distance which makes it easy to pinpoint the right camera for your needs. The DORI distance is calculated based on sensor specification and lab test result according to EN 62676-4 which defines the criteria for Detect, Observe, Recognize and Identify respectively.

DORI Distance (D/O/R/I)

- Detect: 25 ppm
- Observe: 63 ppm
- Recognize: 125 ppm
- Identify: 250 ppm

NETWORK CAMERA

Special Series

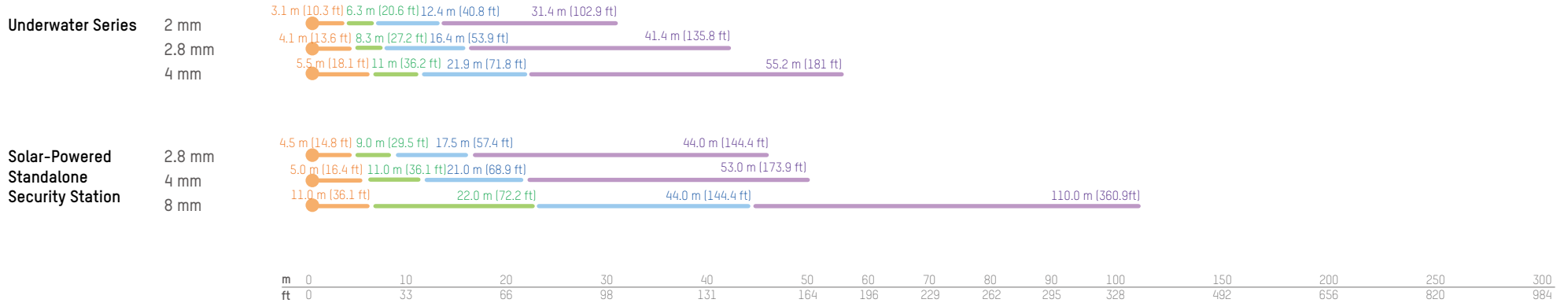

PTZ

Ultra Series

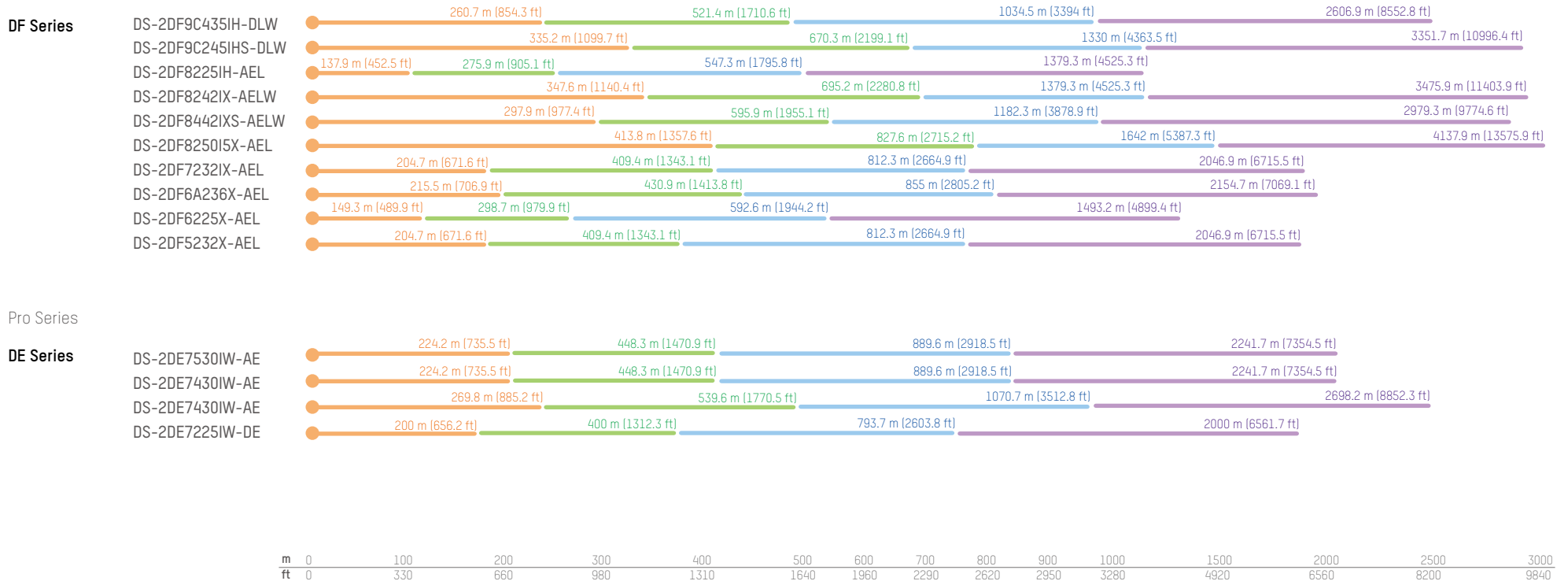

Find the Optimal Camera for Your Individual Security Needs

The DORI distance is a "general proximity" of distance which makes it easy to pinpoint the right camera for your needs. The DORI distance is calculated based on sensor specification and lab test result according to EN 62676-4 which defines the criteria for Detect, Observe, Recognize and Identify respectively.

PTZ

Positioning System

DORI Distance (D/O/R/I)

- Detect: 25 ppm
- Observe: 63 ppm
- Recognize: 125 ppm
- Identify: 250 ppm

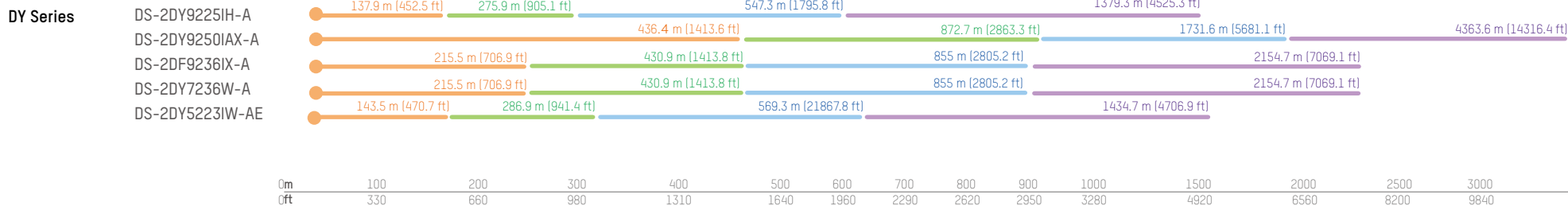

PANORAMIC CAMERA

PanoVu

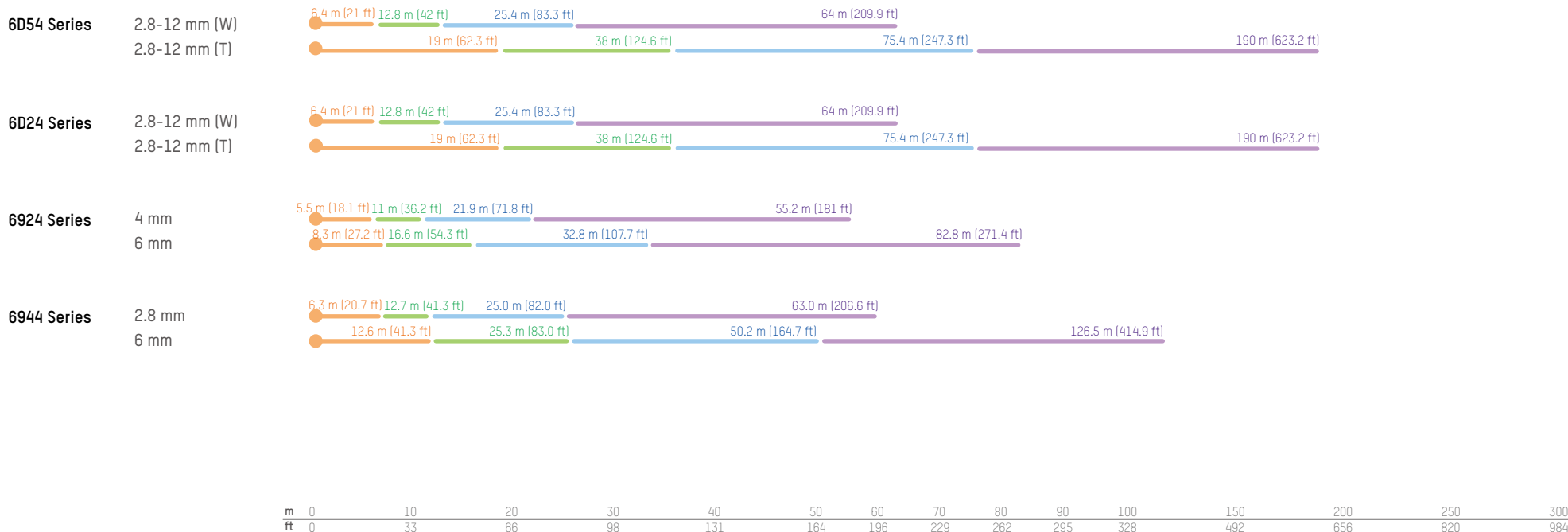

Find the Optimal Camera for Your Individual Security Needs

The DORI distance is a "general proximity" of distance which makes it easy to pinpoint the right camera for your needs. The DORI distance is calculated based on sensor specification and lab test result according to EN 62676-4 which defines the criteria for Detect, Observe, Recognize and Identify respectively.

DORI Distance (D/O/R/I)

- Detect: 25 ppm
- Observe: 63 ppm
- Recognize: 125 ppm
- Identify: 250 ppm

PANORAMIC CAMERA

PanoVu

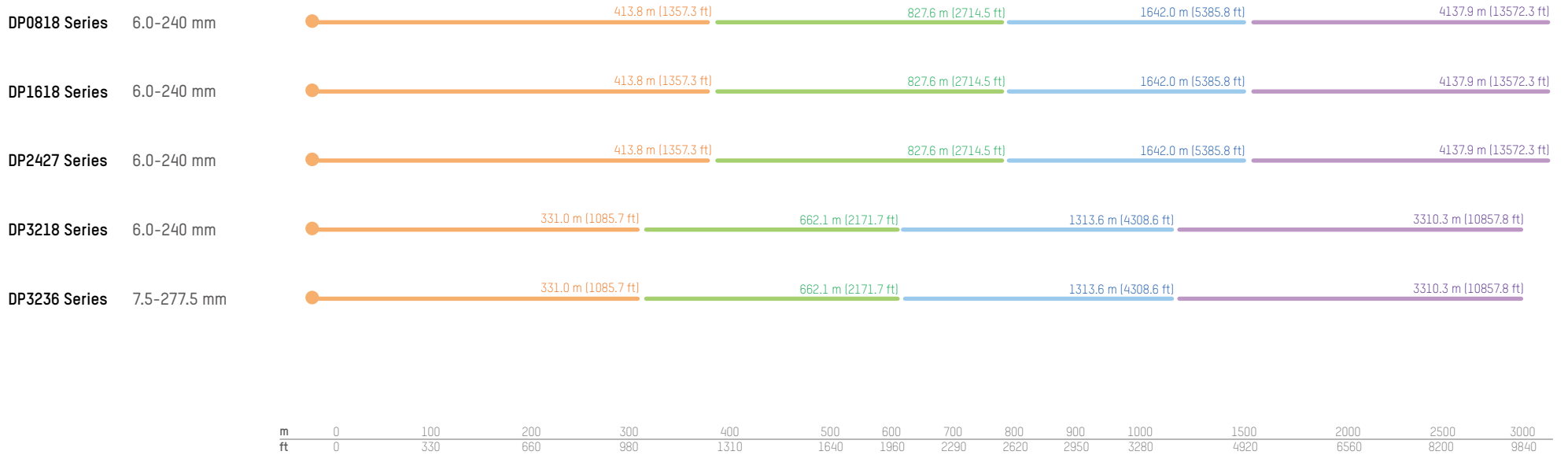

Fisheye

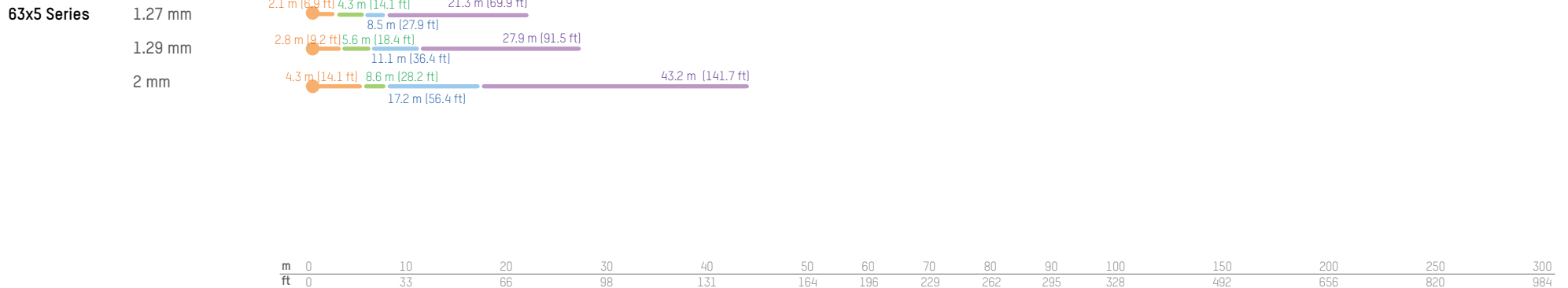

Find the Optimal Camera for Your Individual Security Needs

The DORI distance is a "general proximity" of distance which makes it easy to pinpoint the right camera for your needs. The DORI distance is calculated based on sensor specification and lab test result according to EN 62676-4 which defines the criteria for Detect, Observe, Recognize and Identify respectively.

DORI Distance (D/O/R/I)

- Detect: 25 ppm
- Observe: 63 ppm
- Recognize: 125 ppm
- Identify: 250 ppm

EXPLOSION-PROOF & ANTI-CORROSION

Explosion-Proof Series

XE6452 Series
(Camera)



XE6146 Series
XE6045 Series
(Camera)

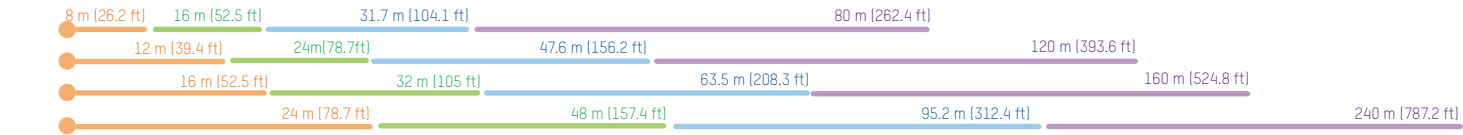

XE6422 Series
(Camera)

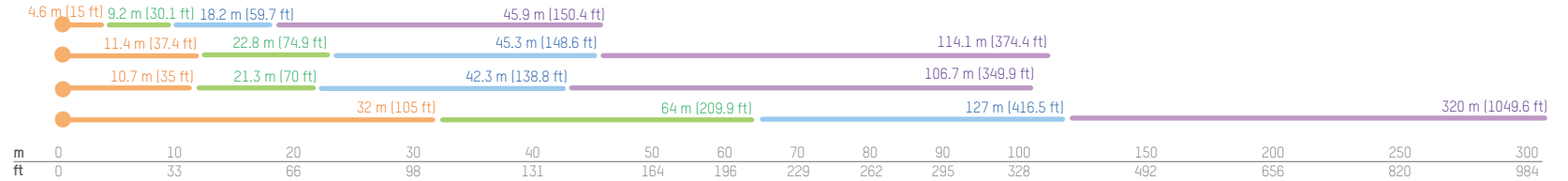

DF6223 Series
DF6236 Series
DY9236 Series
(PTZ)

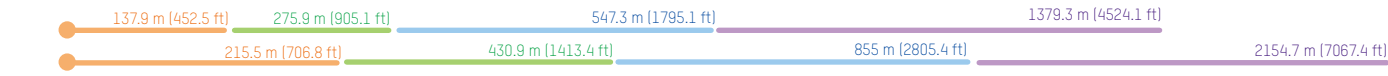

DF4220 Series
(PTZ)

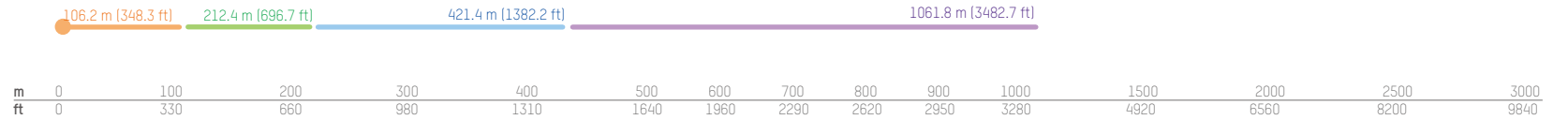

XE6825



XE6845

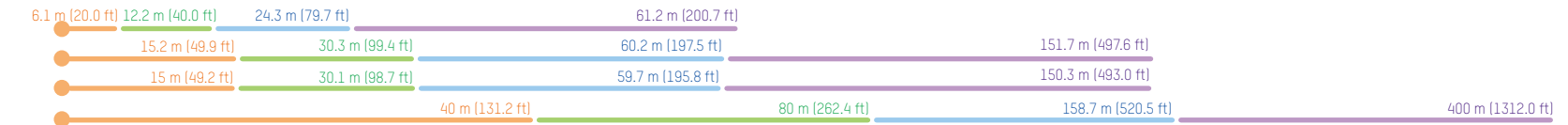

Find the Optimal Camera for Your Individual Security Needs

The DORI distance is a "general proximity" of distance which makes it easy to pinpoint the right camera for your needs. The DORI distance is calculated based on sensor specification and lab test result according to EN 62676-4 which defines the criteria for Detect, Observe, Recognize and Identify respectively.

DORI Distance (D/O/R/I)

- Detect: 25 ppm
- Observe: 63 ppm
- Recognize: 125 ppm
- Identify: 250 ppm

EXPLOSION-PROOF & ANTI-CORROSION

Anti-Corrosion Series Series

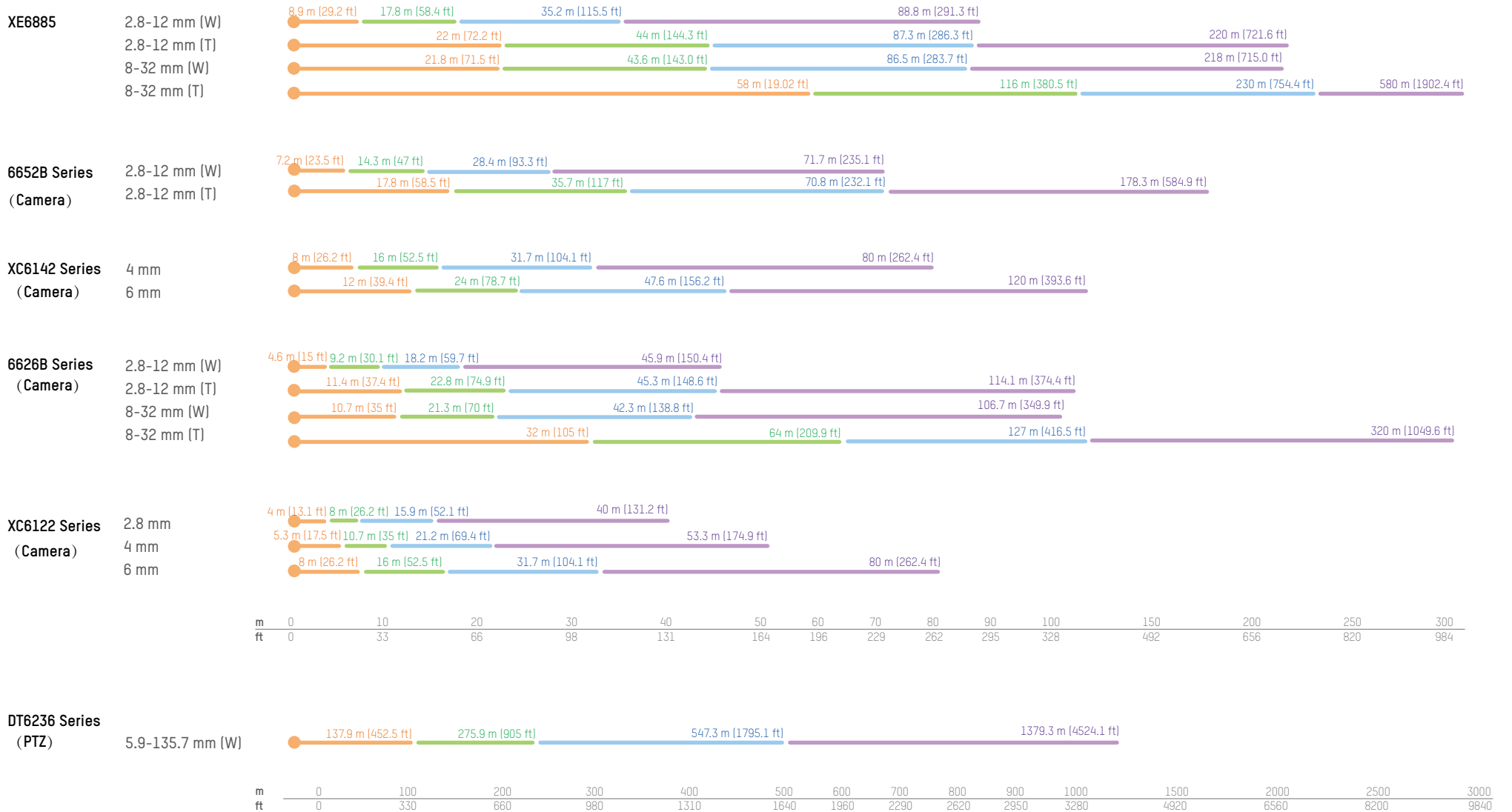

The DRI (Detection Recognition Identification) is defined in terms of the number of pixels on the object depend on a common standard, Johnson's criteria [http://en.wikipedia.org/wiki/Johnson's_criteria].

DORI Distance (D/O/R/I)

- Detection distance
- Recognition distance
- Identification distance

THERMAL

Human (1.8x0.5 m)

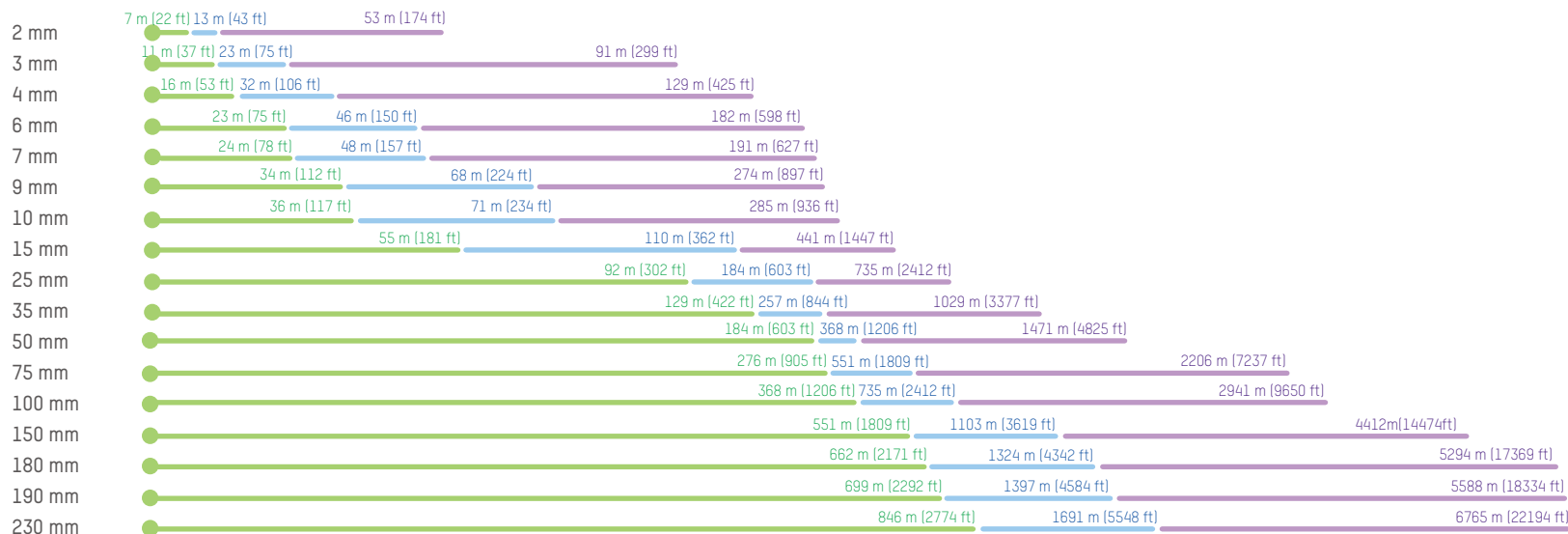

Vehicle (1.4x4.0 m)

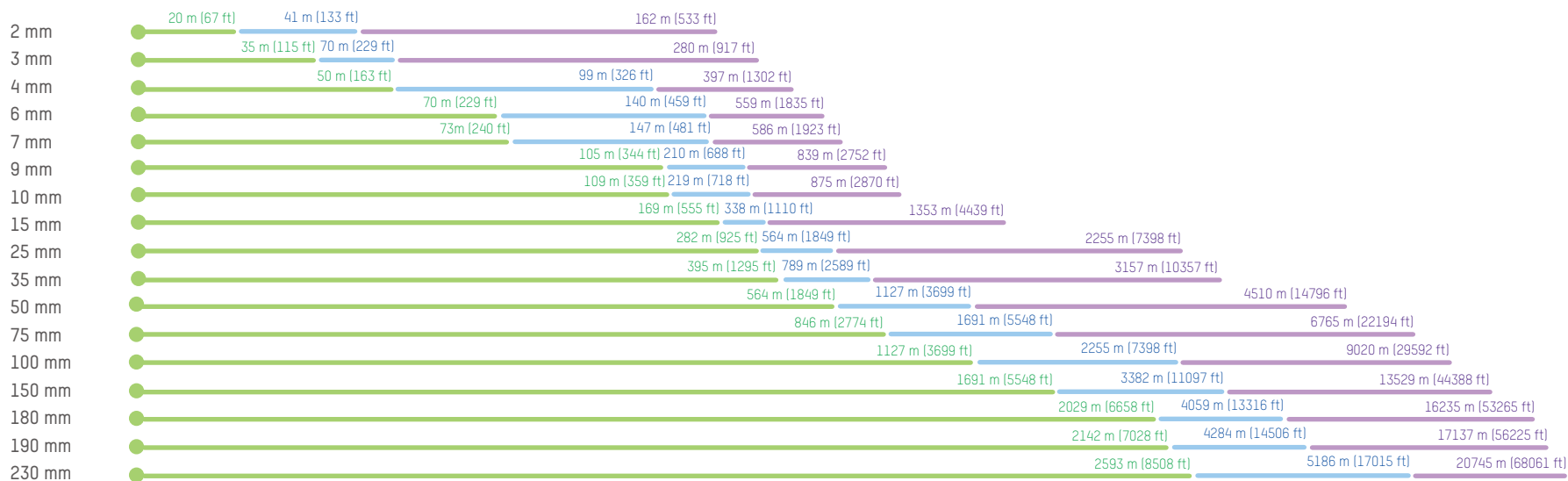

Hikvision Europe

Dirk Storklaan 3
2132 PX Hoofddorp
The Netherlands
T +31 23 5542770
info.eu@hikvision.com

Hikvision France

6 rue Paul Cézanne,
93360 Neuilly-Plaisance
France
T +33 (0)1 85330450
info.fr@hikvision.com

Hikvision Poland

Business Garden, Budynek B3
ul. Żwirki i Wigury 16B,
02-092 Warszawa
T +48 4600150
info.pl@hikvision.com

Hikvision Czech

BETA Building, Vyskocilova
1481/4, Prague 4
Czech Republic
T +42 29 6182640
info.cz@hikvision.com

Hikvision Germany

Werner-Heisenberg Str. 2b
63263 Neu-Isenburg,
Germany
T +49 69 401507290
sales.dach@hikvision.com

Hikvision Romania

Splaiul Independentei street
291-293, Riverside Tower,
12th floor, 6th district,
Bucharest, Romania
T +31235542770/988
marketing.ro@hikvision.com

Hikvision Belgium

Neringenweg 44,
3001 Leuven, Belgium
T +31 23 5542770
info.bnl@hikvision.com

Hikvision Hungary

Budapest, Reichl Kálmán u.
8,
1031, Hungary
T +36 1 323 7650
info.hu@hikvision.com