



DS-TPM400 Guidance Terminal

User Manual

User Manual

COPYRIGHT ©2017 Hangzhou Hikvision Digital Technology Co., Ltd.

ALL RIGHTS RESERVED.

Any and all information, including, among others, wordings, pictures, graphs are the properties of Hangzhou Hikvision Digital Technology Co., Ltd. or its subsidiaries (hereinafter referred to be “Hikvision”). This user manual (hereinafter referred to be “the Manual”) cannot be reproduced, changed, translated, or distributed, partially or wholly, by any means, without the prior written permission of Hikvision. Unless otherwise stipulated, Hikvision does not make any warranties, guarantees or representations, express or implied, regarding to the Manual.


About this Manual

This Manual is applicable to DS-TPM400 Series Guidance Terminal.

The Manual includes instructions for using and managing the product. Pictures, charts, images and all other information hereinafter are for description and explanation only. The information contained in the Manual is subject to change, without notice, due to firmware updates or other reasons. Please find the latest version in the company website (<http://overseas.hikvision.com/en/>).

Please use this user manual under the guidance of professionals.

Trademarks Acknowledgement

 and other Hikvision’s trademarks and logos are the properties of Hikvision in various jurisdictions. Other trademarks and logos mentioned below are the properties of their respective owners.

Legal Disclaimer

TO THE MAXIMUM EXTENT PERMITTED BY APPLICABLE LAW, THE PRODUCT DESCRIBED, WITH ITS HARDWARE, SOFTWARE AND FIRMWARE, IS PROVIDED “AS IS”, WITH ALL FAULTS AND ERRORS, AND HIKVISION MAKES NO WARRANTIES, EXPRESS OR IMPLIED, INCLUDING WITHOUT LIMITATION, MERCHANTABILITY, SATISFACTORY QUALITY, FITNESS FOR A PARTICULAR PURPOSE, AND NON-INFRINGEMENT OF THIRD PARTY. IN NO EVENT WILL HIKVISION, ITS DIRECTORS, OFFICERS, EMPLOYEES, OR AGENTS BE LIABLE TO YOU FOR ANY SPECIAL, CONSEQUENTIAL, INCIDENTAL, OR INDIRECT DAMAGES, INCLUDING, AMONG OTHERS, DAMAGES FOR LOSS OF BUSINESS PROFITS, BUSINESS INTERRUPTION, OR LOSS OF DATA OR DOCUMENTATION, IN CONNECTION WITH THE USE OF THIS PRODUCT, EVEN IF HIKVISION HAS BEEN ADVISED OF THE POSSIBILITY OF SUCH DAMAGES.




REGARDING TO THE PRODUCT WITH INTERNET ACCESS, THE USE OF PRODUCT SHALL BE WHOLLY AT YOUR OWN RISKS. HIKVISION SHALL NOT TAKE ANY RESPONSIBILITIES FOR ABNORMAL OPERATION, PRIVACY LEAKAGE OR OTHER DAMAGES RESULTING FROM CYBER ATTACK, HACKER ATTACK, VIRUS INSPECTION, OR OTHER INTERNET SECURITY RISKS; HOWEVER, HIKVISION WILL PROVIDE TIMELY TECHNICAL SUPPORT IF REQUIRED.

SURVEILLANCE LAWS VARY BY JURISDICTION. PLEASE CHECK ALL RELEVANT LAWS IN YOUR JURISDICTION BEFORE USING THIS PRODUCT IN ORDER TO ENSURE THAT YOUR USE CONFORMS THE APPLICABLE LAW. HIKVISION SHALL NOT BE LIABLE IN THE EVENT THAT THIS PRODUCT IS USED WITH ILLEGITIMATE PURPOSES.

IN THE EVENT OF ANY CONFLICTS BETWEEN THIS MANUAL AND THE APPLICABLE LAW, THE LATER PREVAILS.

Symbol Conventions

The symbols that may be found in this document are defined as follows.

Symbol	Description
 NOTE	Provides additional information to emphasize or supplement important points of the main text.
 WARNING	Indicates a potentially hazardous situation, which if not avoided, could result in equipment damage, data loss, performance degradation, or unexpected results.
 DANGER	Indicates a hazard with a high level of risk, which if not avoided, will result in death or serious injury.

Safety Instructions

- Please adopt the power adapter which can meet the safety extra low voltage (SELV) standard.
- To reduce the risk of fire or electrical shock, do not expose this product to rain or moisture.
- This installation should be made by a qualified service person and should conform to all the local codes.
- Please install blackouts equipment into the power supply circuit for convenient supply interruption.
- If the product does not work properly, please contact your dealer or the nearest service center. Never attempt to disassemble the camera yourself. (We shall not assume any responsibility for problems caused by unauthorized repair or maintenance.)

Preventive and Cautionary Tips

- Make sure the power supply voltage is correct before using the camera.
- Do not drop the guidance machine or subject it to physical shock.
- Do not place the camera in extremely hot, cold temperatures (please refer to the product specification for the operating temperature), dusty or damp environment, and do not expose it to high electromagnetic radiation.
- To avoid heat accumulation, good ventilation is required for a proper operating environment.
- Keep the guidance terminal away from water and any liquid.
- While shipping, the guidance terminal should be packed in its original packing.
- Improper use or replacement of the battery may result in hazard of explosion. Please use the manufacturer recommended battery type.
- The additional equipment of PoE ports shall comply with requirement of fire enclosure.

Table of Contents

Chapter 1	Introduction	4
1.1	Description	4
1.2	Features and Functions	4
1.3	Application Scenario	5
Chapter 2	Installation	7
2.1	Structure Overview	7
2.1.1	Mainboard	7
2.1.2	Power Cord	8
2.2	Installation	8
Chapter 3	Activation and Login	12
3.1	Network Connection	12
3.2	Activation	12
3.2.1	Activating via SADP	13
3.2.2	Activating via Web Browser	15
3.3	Logging in via Web Browser	16
Chapter 4	Configuration	19
4.1	Local Configuration	19
4.2	Remote Configuration	20
4.2.1	Configuring Device Parameters	20
4.2.2	Managing Camera	22
4.2.3	Configuring Camera	26
4.2.4	Configuring Network	35
4.2.5	Configuring Serial Port	38
4.2.6	Configuring Alarm	39
4.2.7	Controlling Indicator	42
4.2.8	Configuring Exception	43
4.2.9	Managing User	44
4.2.10	Managing HDD	46
4.2.11	Running Log	47
4.2.12	Maintenance	47
4.2.13	Connecting to Platform	48
4.2.14	Configuring Remote Host	50
4.2.15	Viewing Status	50
Chapter 5	Live View	52

Chapter 6 Playback	54
6.1 Playback Interface.....	54
6.2 Searching Record Files.....	55
Chapter 7 Log	56
7.1 Searching Log Files	56
Chapter 8 Data Search	58
Chapter 9 Status	59
Chapter 10 Statistics	61
10.1 Viewing Parking Space Information	61
10.2 Viewing LED Guidance Screen Information	62

Chapter 1 Introduction

1.1 Description

DS-TPM400 series guidance terminal, based on the 4-core ARM Cortex-A17 processor, is a remarkable intelligent management system used for underground garage. Adopting the advanced parking guidance and find my car system, the guidance terminal is capable of connecting multiple parking cameras to realize parking space detection, license plate recognition, guidance screen information control, video storage, playback, etc.

The guidance terminal is widely used in the parking lot of the community, business center and hotels. It greatly shortens the parking time and vehicle searching time of customers, and improves the utilization of the spare parking spaces.

The models and description are shown in the following table.

Model	Description
DS-TPM400	Connectable to parking cameras via external power cord.
DS-TPM400-P	Supports PoE, and connectable to Hikvision PoE parking cameras of the fourth generation.

1.2 Features and Functions

- H.264 decoding to output the parking space detection and license plate recognition algorithm results.
- Connectable to guidance screen, displaying the available parking spaces no matter it is online or offline.
- Quick access to parking cameras, and batch configuration of parking cameras to save the time cost of manual operation, monitor vehicles, and get event evidence effectively.
- Alternate indicator control. The parking camera can display the status of the

opposite parking space.

- Accessible by web browser and integrated SDK. Accessible to platform via Ehome protocol, and Hik-Connect platform.
- Dual NIC, which can connect to the internet and intranet and save IP resource.
- Optical fiber access.
- 16 RJ45 network interfaces, connectable to up to 32 parking cameras. Among the 16 network interfaces, 8 interfaces support Hikvision PoE parking cameras connection. Another 4 1000M network interfaces are supported.
- 2 RS-485 serial ports to connect to the RS-485 control devices, such as guidance screen.
- Supports up to 18 TB HDD storage.

1.3 Application Scenario

Parking cameras can be connected to the guidance terminal via network to realize the integrated management, video search, record, playback, etc. Refer to the following figure for the application scenario of the guidance terminal.

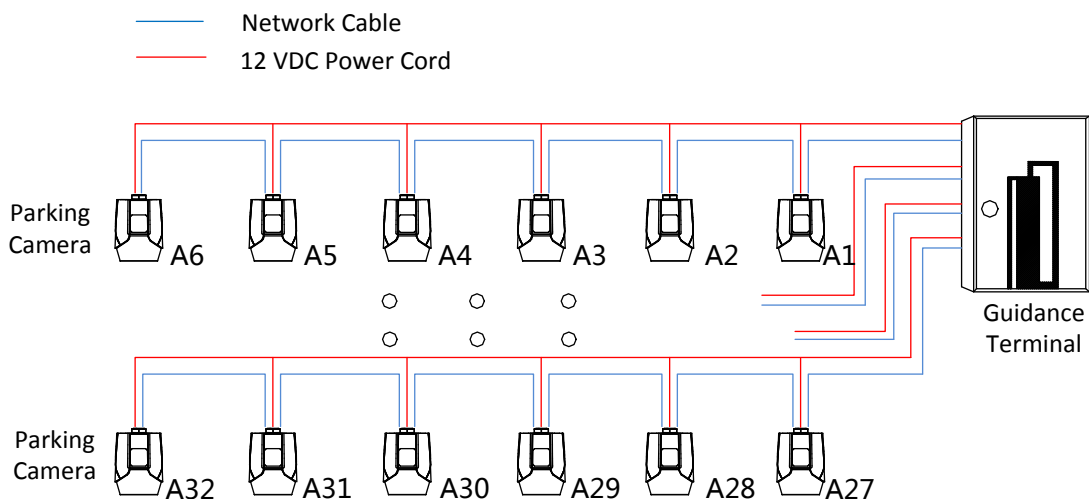


Figure 1-1 Application Scenario for DS-TPM400

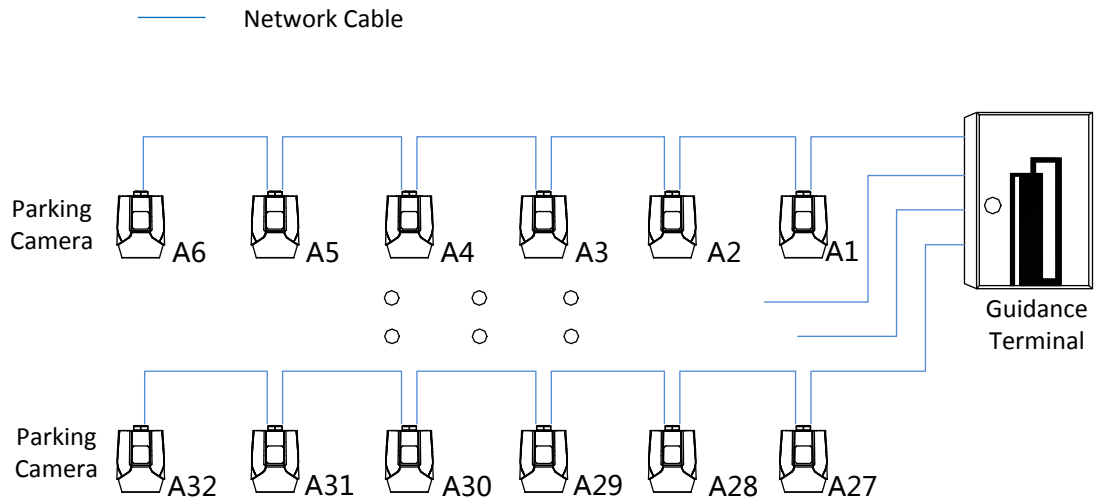


Figure 1-2 Application Scenario for DS-TPM400-P

i NOTE

- Refer to *User Manual of Parking Camera* for the installation.
- When PoE parking camera is connected to DS-TPM400-P guidance terminal, it can be powered by the network cable directly.
- Only the Hikvision PoE parking camera of the fourth generation can be connected to the DS-TPM400-P guidance terminal.

Chapter 2 Installation

2.1 Structure Overview

2.1.1 Mainboard

Refer to the following figure and table for the interfaces of the guidance terminal. Parking cameras can be connected to the guidance terminal via corresponding interfaces.

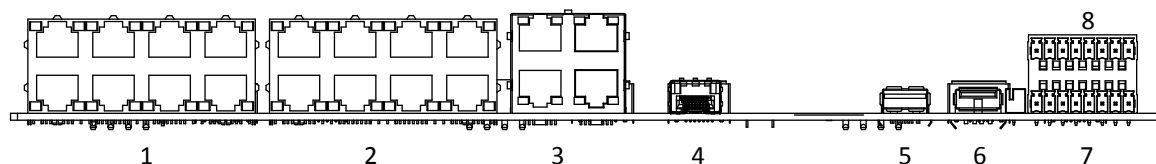


Figure 2-1 Interfaces

Table 1-1 Interfaces Description

No.	Name	Description
1	10/100M: Power & Data	8 100M network interfaces, connecting to the Hikvision PoE parking cameras.
2	10/100M	8 100M network interfaces for connecting to parking cameras in hand-in-hand mode. They do not support PoE.
3	10/100/1000M	4 1000M network interfaces for platform software or PC access.
4	OPT	1 optical port. SFP optical module is needed for network communication.
5	USB 3.0	1 USB 3.0 interface for connecting to mouse, keyboard, USB flash drive, etc.
6	USB 2.0	1 USB 2.0 interfaces for connecting to mouse, keyboard, USB flash drive, etc.
7	RS 485 Interface	2 RS-485 interfaces.
8	ALARM IN/OUT	2-ch alarm input. IN and G are a pair of alarm input. 2-ch alarm output. C1 and NO1 are a pair of relay alarm output. F2+ and F3+ are I/O alarm outputs. You can connect corresponding alarm input/output devices according to needs.

2.1.2 Power Cord

Refer to the following figure and table for the power cord description.

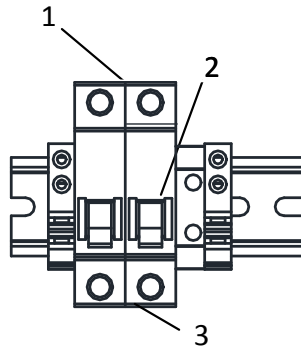


Figure 2-2 Power Cord

Table 1-2 Power Cord

No.	Name	Description
1	Power Output	220 VAC power output
2	Air Switch	1 air switch for controlling the circuit connected or disconnected, and overcurrent protection.
3	Power Input	100 to 240 VAC power input

2.2 Installation

Before you start:

Check the installation environment.

- Install the guidance terminal in the location where it is large enough to install the expansion screws.
- The installation location should bear at least 4 times of the weight of the guidance terminal and accessory.
- The installation location should be large enough to contain the guidance terminal

and accessory.

Steps:

1. Rotate the key in the keyhole of the guidance terminal and open the cover of the machine body.

NOTE

If the guidance terminal supports PoE, it has 2 parts of power supply. The upper part is used to provide power for cameras and terminal with 12 VDC. The lower part is used to provide power for the PoE interfaces with 48 VDC.

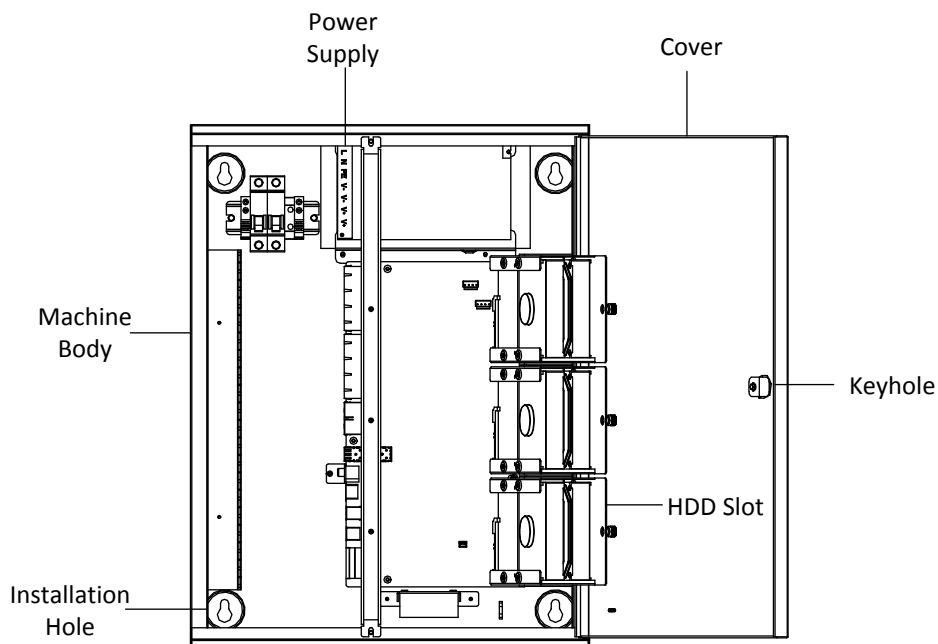


Figure 2-3 Open the Cover

2. Install HDD.
 - 1) Loosen the set screws of the HDD and terminal, and lift the HDD slot to the appropriate position.
 - 2) Insert HDD to the slot, and fix it with 4 SC-CUNC6-32*5 screws.
 - 3) Repeat step 1) and 2) to install other HDDs. Each HDD should be fixed with 4 screws.
 - 4) Lay down the HDD slot, and use M3 screw to fix the screw hole. Tighten the nut to fix the HDD slot to the terminal.
3. Drill 4 Ø8 screw holes on the wall according to the figure below and fasten the

expansion screws into the drilled screw holes on the wall.

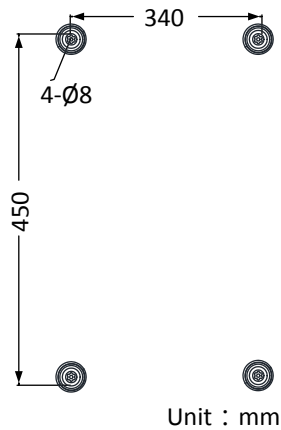


Figure 2-4 Drill Screw Holes

4. Align the four installation holes on the machine body to the four expansion screws on the wall to hook the terminal on the screws.
5. Connect network cable and power cord in the machine body, and route the cables from the corresponding outlet holes according to the figure below.

 **NOTE**

- Route the power cord from strong current outlet hole and other cables from weak current outlet hole.
- The weak current outlet hole is used for routing camera power cord, network cable, etc.
- The strong current outlet hole is used for routing the 220 VAC power cord.

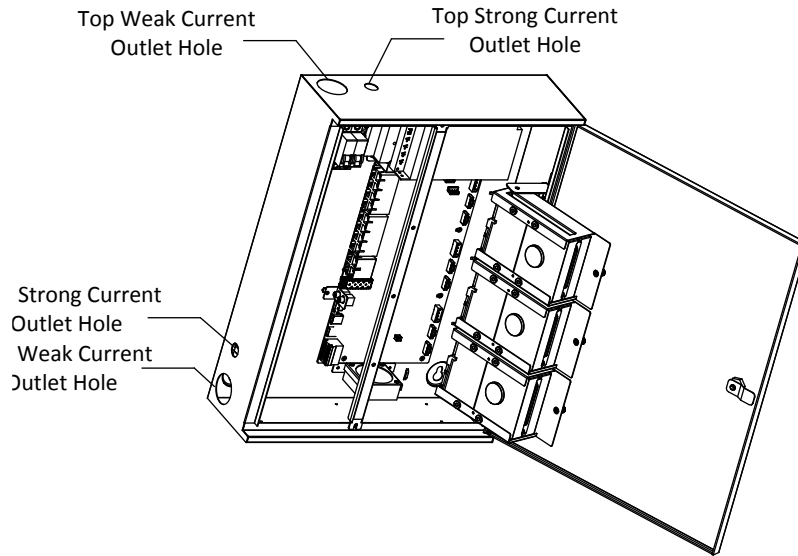


Figure 2-5 Wiring

6. Close the cover and lock the key to finish the installation.

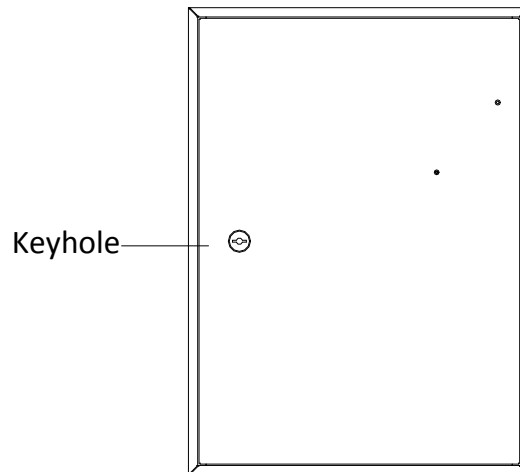


Figure 2-6 Lock the Key

Chapter 3 Activation and Login

3.1 Network Connection

NOTE

You shall acknowledge that the use of the product with Internet access might be under network security risks. For avoidance of any network attacks and information leakage, please strengthen your own protection. If the product does not work properly, please contact with your dealer or the nearest service center.

Other devices including LED display units, parking cameras, control platforms, etc. can be connected to the guidance terminal. The following figure takes an example of the device connection for DS-TPM400.

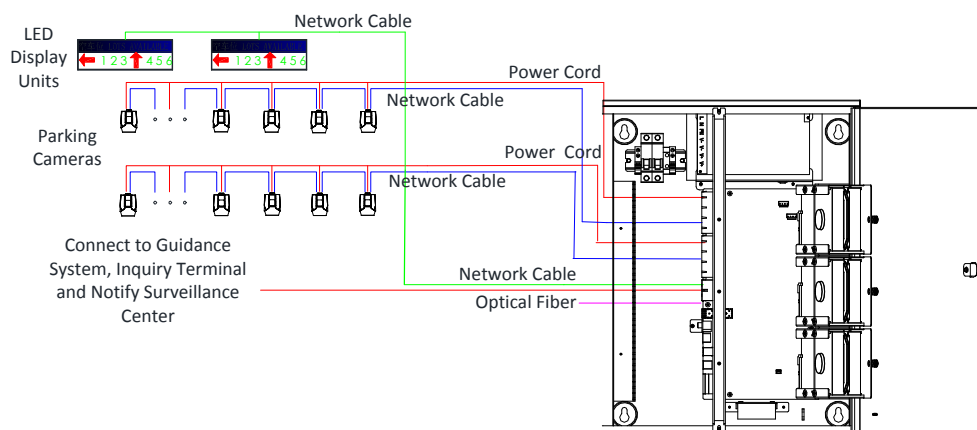


Figure 3-1 Device Connection

3.2 Activation

You need to active the device and set the password for first-time login. You can activate the device through SADP or through web browser.

NOTE

- By default, the IP address of the guidance terminal is 192.168.1.64.
- The default port: 8000 port for SDK activation, 80 port for web browser activation, and 37020 port for SADP activation.

- The default user account: admin.

3.2.1 Activating via SADP



SADP software is enclosed on the compact disc. You can also download it from the company website.

Steps:

1. Install SADP software. After launching the SADP software, it automatically searches the online devices every 1 minute from the subnet where your computer locates. It displays the total number and information of the searched devices in the device list. Device information including the device type, IP address, port number, gateway, etc. will be displayed as the figure below.

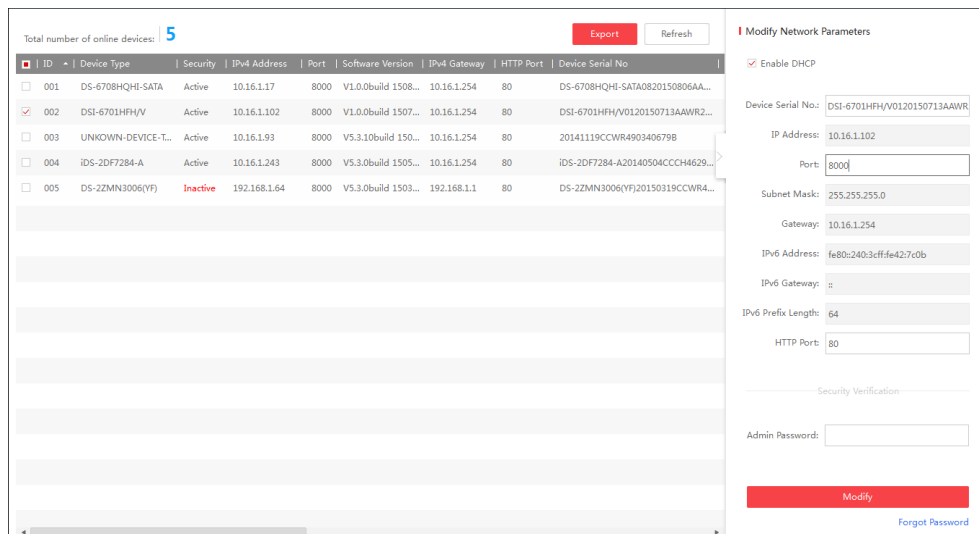


Figure 3-2 SADP Activation

2. Select the device which you need to activate by checking the checkbox and the device information will be displayed in a list on the right side. In **Activate the Device** panel, create a password for the device and confirm the password. The system will judge password strength automatically, and we highly recommend you to use a strong password to ensure your data security.

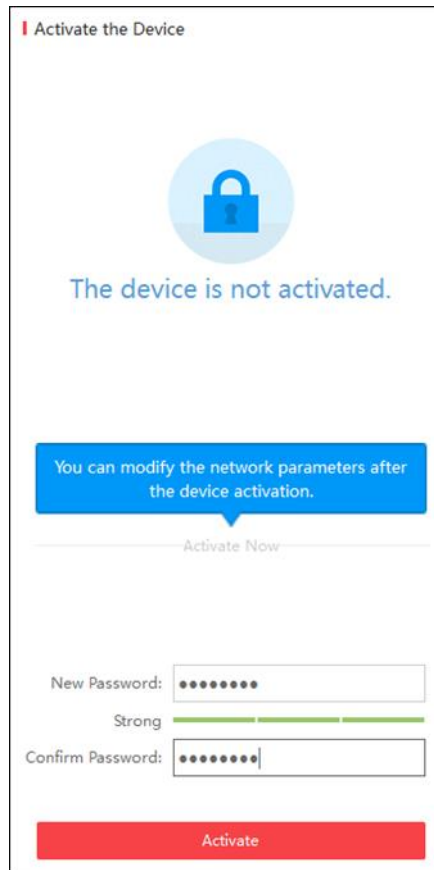


Figure 3-3 Create the Password



STRONG PASSWORD RECOMMENDED—A strong password ranges from 8 to 16 characters, and must contain at least two of the following categories: numbers, lowercases, uppercases and special characters. And we recommend you reset your password regularly, especially in the high security system, resetting the password monthly or weekly can better protect your product.

3. Click **Activate** to activate the device. A “The device is activated.” hint window pops up when the password is set successfully.
4. Modify the network parameters. Select the device to be modified in the device list by checking the checkbox and the network parameters of the device will be displayed in **Modify Network Parameters** panel on the right side. Set the network parameters including IP address, sub network mask, gateway, etc.

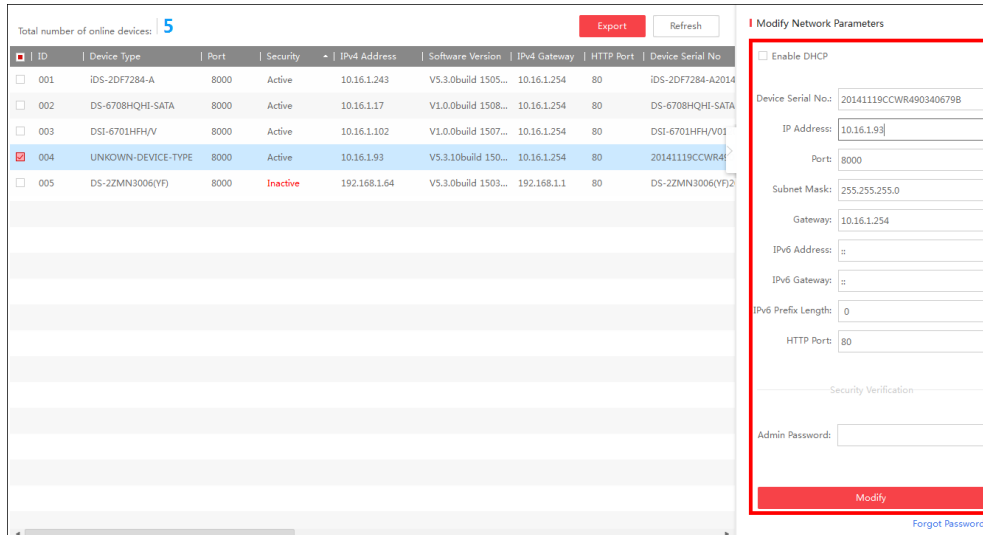


Figure 3-4 Modify the Parameters

5. Enter the password of the admin account of the device in the **Admin Password** field and click **Modify** to modify the parameters.

NOTE

- When setting IP address, keep the device IP address and the computer IP address in the same network segment.
- “Admin” is device’s administrator user. We recommend you to create a new user to operate for protecting your data security.

3.2.2 Activating via Web Browser

Steps:

1. Modify the IP address of your computer to ensure the computer IP address and the device IP address are in the same network segment.

NOTE

The default IP address of the guidance terminal is 192.0.0.64.

2. Input the default IP address of the guidance terminal in the address bar of the web browser and the activation interface pops up. Enter a new password and click **OK** to activate the device as the figure below.

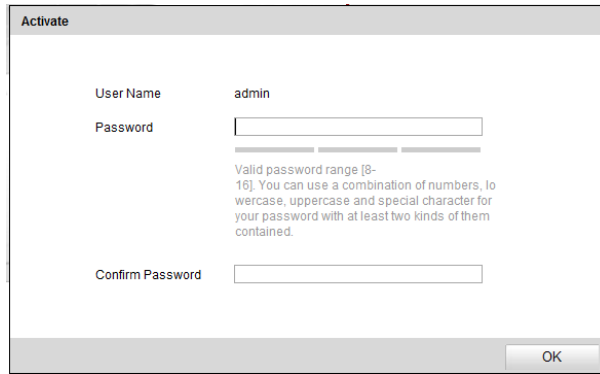


Figure 3-5 Activate through Web Browser

3.3 Logging in via Web Browser

Purpose:

You can log in to the guidance terminal via web browser for further operations such as live view, playback, local configuration, etc.

Steps:

1. In the address bar of the web browser, input the IP address of the guidance terminal, and press the **Enter** key to enter the login interface. A login window displays.

NOTE

- By default, the IP address of the guidance terminal is 192.0.0.64.
 - You are recommended to use web browser of IE 8 or above.
2. Input the user name and password of the guidance terminal.

NOTE

- By default, the user name for login is **admin** and the password is **12345**.
- You are highly recommended to change the default password right after the first login to avoid safety problem.

WARNING

CHANGE DEFAULT PASSWORD—The default Admin account password (12345) is for first-time log-in purposes only. You must change this default password to better

protect against security risks, such as the unauthorized access by others to the product that may prevent the product from functioning properly and/or lead to other undesirable consequences.

3. Click **Login**.

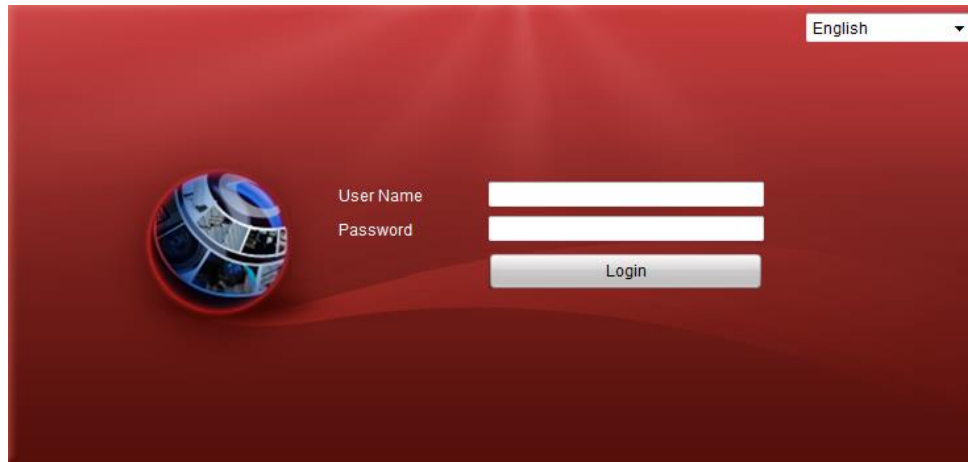


Figure 3-6 Login Interface

4. You are required to change the default password after first login for security purpose. Click **OK** to change the password in User Management interface.

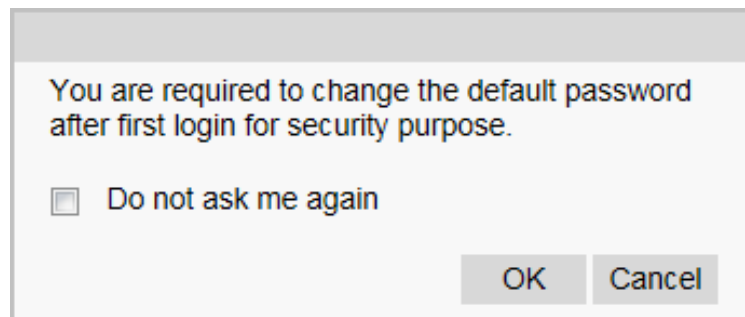


Figure 3-7 Change the Default Password

5. For the first time to login, you should install the plug-in before you can access the functions. Click **Please click here to download and install the plug-in. Close the browser when installing the plug-in.** on the live view page, run and install the plug-in according to the prompt. After the installation of plug-in, re-open the web browser and login.



NOTE

Please close your web browser during the installation of the plug-in.

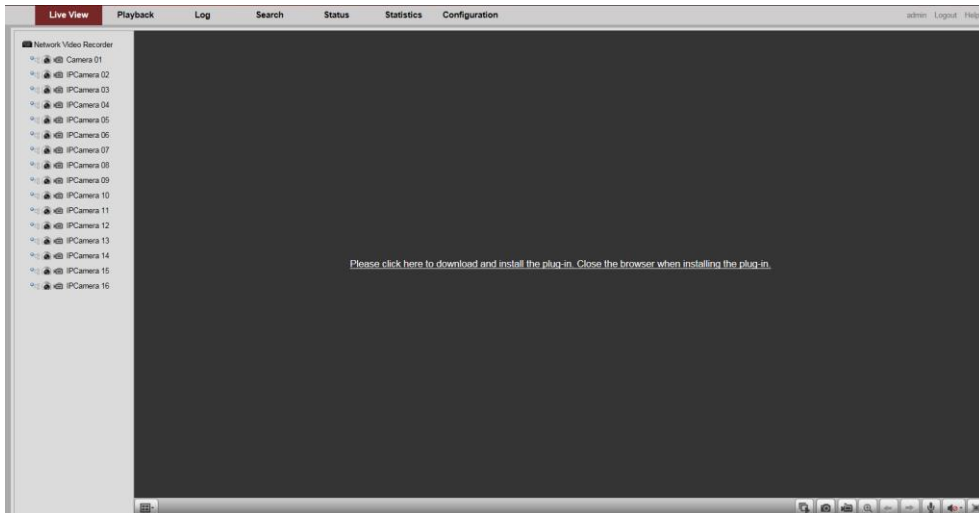


Figure 3-8 Install the Plug-in

6. After login, the interface is shown as below.

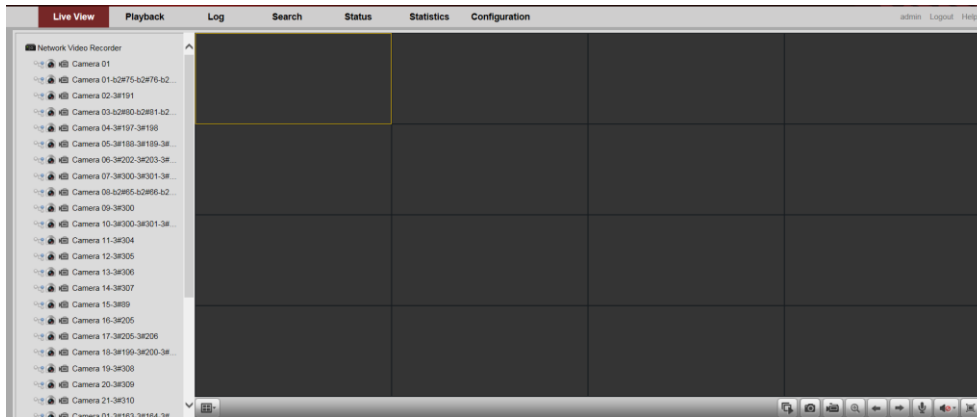


Figure 3-9 Live View Window

Chapter 4 Configuration

Purpose:

The parameters, such as protocol, stream type, network, alarm, etc., can be configured via the web browser.

Click **Configuration** tab to enter the Configuration page.

4.1 Local Configuration

Steps:

1. Go to **Configuration > Local Configuration**.

The screenshot shows the 'Local Configuration' page with the following settings:

- Protocol: TCP
- Stream Type: Main Stream
- Image Size: Auto-fill
- Record File Size: 512M
- Live View Performance: Balanced
- Auto Start Live View: No
- Highlight Event Area: Disable
- Save record files to: E:\
- Save snapshots in live view to: E:\
- Save snapshots when playback to: E:\
- Save clips to: E:\
- Save downloaded files to: E:\

Each file path field has a 'Browse' button next to it. A 'Save' button is located at the bottom left of the configuration area.

Figure 4-1 Local Configuration

2. Set the corresponding parameters such as protocol, stream type, image size, etc. as desired.
3. Click **Browse** to select a local saving path for the files.
4. Click **Save** to save the settings.

Refer to the following descriptions of local configuration parameters.

Parameter	Description
Protocol	TCP/UDP are selectable.

Parameter	Description
Stream Type	Main Stream/Sub-Stream are selectable.
Image Size	Auto-fill/4:3/16:9 are selectable.
Record File Size	256M/512M/1G are selectable.
Live View Performance	Shortest Delay/Real Time/Balanced/Fluency are selectable.
Auto Start Live View	No/Yes are selectable.
Highlight Event Area	Enable/Disable are selectable.
Save record files to	C:\Users\TSP Web\ RecordFiles (Default Path)
Save snapshots in live view to	C:\Users\TSP Web\ CaptureFiles (Default Path)
Save snapshots when playback to	C:\Users\TSP Web\PlaybackPics (Default Path)
Save clips to	C:\Users\TSP Web\PlaybackFiles (Default Path)
Save downloaded files to	C:\Users\TSP Web\DownloadFiles (Default Path)

4.2 Remote Configuration

4.2.1 Configuring Device Parameters

Configuring Device Information

You can edit the Device Name and Device No., and view the device Model, Serial No., Firmware Version, Encoding Version, Number of Channels, Number of HDDs, Number of Alarm Input and Number of Alarm Output in the Basic Information interface.

Basic Information	
Device Name	Network Video Recorder
Device No.	255
Model	DS-TPM400-P
Serial No.	DS-TPM400-P 1620161109AARR00
Firmware Version	V3.0.1 build 170614
Encoding Version	V5.0 build 20170605 15:32:00(lib 201
Kernel Version	v1.0.8885
Algorithm Version	PR 421143176(DET 71377548)
Number of Channels	32
Number of HDDs	1
Number of Alarm Input	3
Number of Alarm Output	3

Save

Figure 4-2 Basic Information

Configuring Time

You can configure the time in the Time Settings interface, including Time Zone, synchronization (NTP Time Synchronization or Manual Time Synchronization).


Time Settings	
Time Zone	(GMT+08:00) Beijing, Urumqi, Singapore
NTP	
<input type="radio"/> NTP	
Server Address	192.0.7.166
NTP Port	123
Interval	60 min.
Manual Time Sync.	
<input checked="" type="radio"/> Manual Time Sync.	
Device Time	2017-06-22T15:34:19
Set Time	2017-06-22T15:33:31 <input type="checkbox"/> Sync. with computer time

Save

Figure 4-3 Time Setting

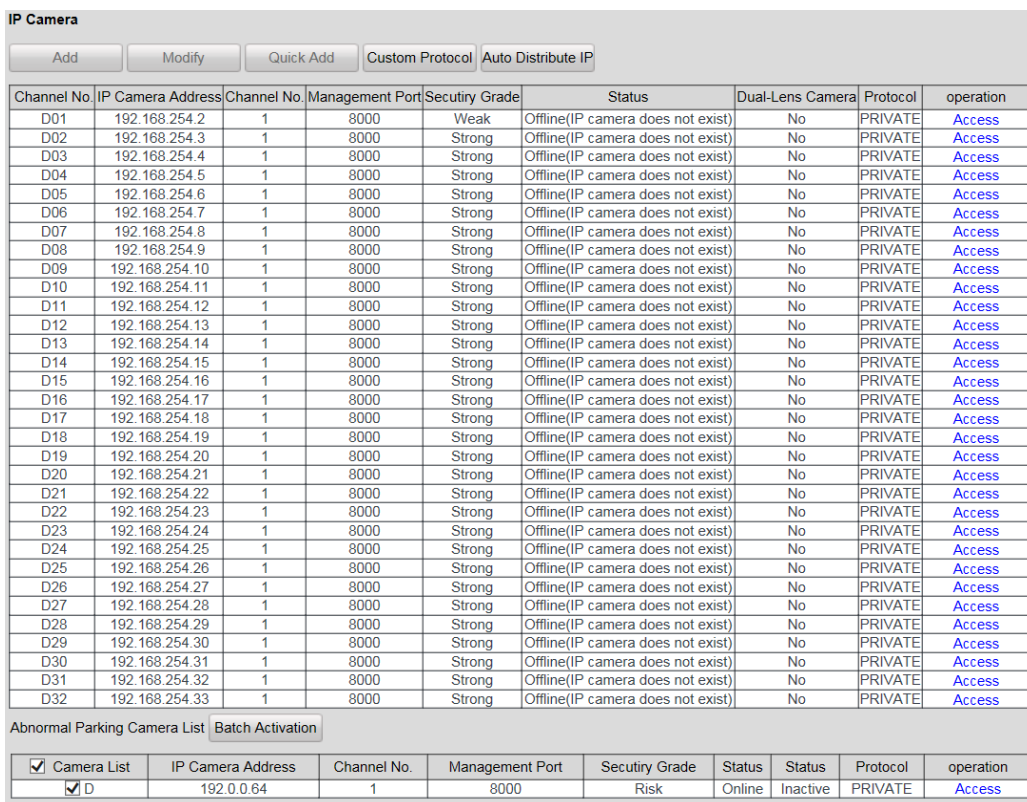
NTP: After enabling NTP, the NTP server will synchronize the device time at regular intervals. Click before NTP to enable it, and input the Server Address, NTP Port and Interval.

Manual Time Sync.: After enabling Manual Time Synchronization, the device time

can be synchronized with the setting time or the computer time. Click  before Manual Time Sync. to enable it, and input the time as desired. Or you can check the checkbox of **Sync. with computer time.**

4.2.2 Managing Camera

In the IP Camera interface, the guidance terminal is capable of connecting up to 32 parking cameras.



The screenshot shows the 'IP Camera' management interface. At the top, there are buttons for 'Add', 'Modify', 'Quick Add', 'Custom Protocol', and 'Auto Distribute IP'. Below these is a table listing 32 cameras (D01 to D32). Each row contains: Channel No., IP Camera Address, Channel No., Management Port, Security Grade, Status, Dual-Lens Camera, Protocol, and operation. All cameras have a Management Port of 8000 and a Protocol of PRIVATE. The Status for all is 'Offline(IP camera does not exist)'. The operation column contains a blue 'Access' link for each camera.

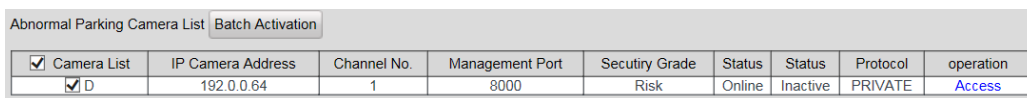
Below the main table is the 'Abnormal Parking Camera List' section, which includes a 'Batch Activation' button and a table with the following data:

<input checked="" type="checkbox"/> Camera List	IP Camera Address	Channel No.	Management Port	Security Grade	Status	Status	Protocol	operation
<input checked="" type="checkbox"/> D	192.0.0.64	1	8000	Risk	Online	Inactive	PRIVATE	Access

Figure 4-4 IP Camera Management

Activating Parking Camera

If the parking camera is inactive, it will be listed in the Abnormal Parking Camera List. You can activate the inactive cameras in batch.



The screenshot shows the 'Abnormal Parking Camera List' interface with the 'Batch Activation' button. The table below shows the camera 'D' is now 'Online' and 'Inactive', indicating it has been successfully activated.

<input checked="" type="checkbox"/> Camera List	IP Camera Address	Channel No.	Management Port	Security Grade	Status	Status	Protocol	operation
<input checked="" type="checkbox"/> D	192.0.0.64	1	8000	Risk	Online	Inactive	PRIVATE	Access

Figure 4-5 Batch Activation

1. Check the inactive parking camera(s).

2. Click **Batch Activation**.

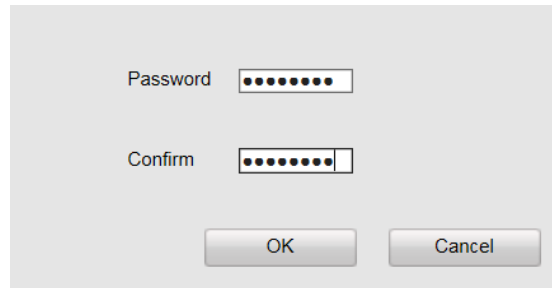
A dialog box for batch activation. It contains two text input fields: the first is labeled 'Password' and the second is labeled 'Confirm'. Both fields are filled with dots, indicating that the text is hidden. Below the input fields are two buttons: 'OK' and 'Cancel'.

Figure 4-6 Batch Activation

3. Enter the password, and confirm it.



WARNING

STRONG PASSWORD RECOMMENDED—We highly recommend you create a strong password of your own choosing (Using a minimum of 8 characters, including at least three of the following categories: upper case letters, lower case letters, numbers, and special characters.) in order to increase the security of your product. And we recommend you reset your password regularly, especially in the high security system, resetting the password monthly or weekly can better protect your product.

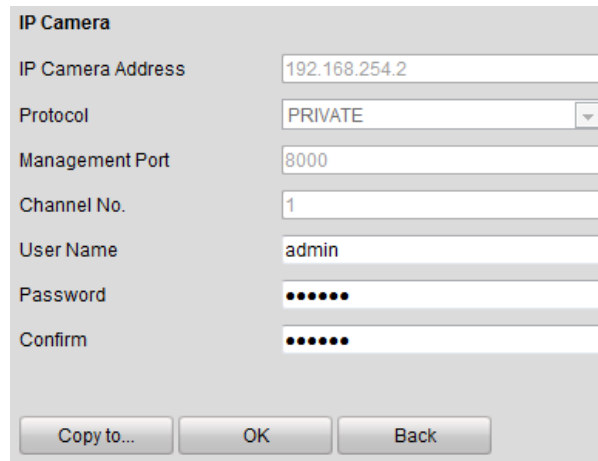
4. Click **OK** to activate the camera(s).

Adding Parking Camera

- Click **Auto Distribute IP** and the IP address of the camera is auto- allocated. The fourth number of the host ranges from 2 to 17. If the IP is occupied, the number will be extended and if the IP is not in the specified network segment of the guide terminal, the IP of camera will be modified to be in the same network segment with the system.
- The status of the camera will be **Offline** if the camera is not connected.
- When the camera is connected, the IP address will be allocated according to the network interface of the camera and the fourth number of the host ranges from 2 to 17. The status of the camera will be **Online**.

Modifying Parking Camera

1. Select a camera and the item becomes blue.
2. Click **Modify** and you can modify the information including user name and password.



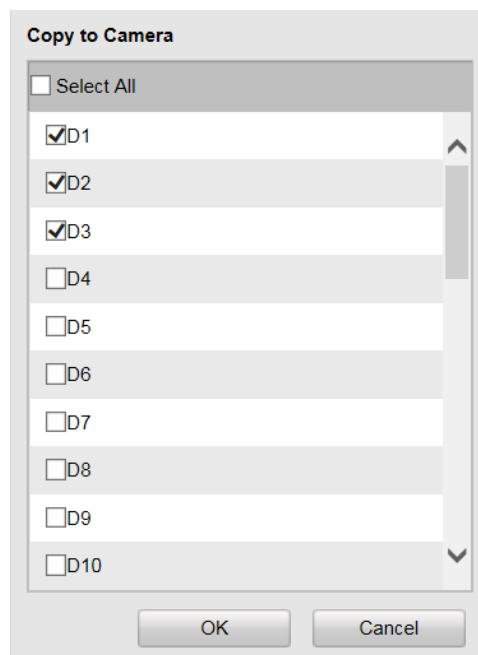
The screenshot shows a dialog box titled "IP Camera" with the following fields and values:

IP Camera Address	192.168.254.2
Protocol	PRIVATE
Management Port	8000
Channel No.	1
User Name	admin
Password	••••••
Confirm	••••••

At the bottom of the dialog box are three buttons: "Copy to...", "OK", and "Back".

Figure 4-7 Modify Parking Camera

3. (Optional) Click **Copy to** to copy the settings to other camera(s).



The screenshot shows a dialog box titled "Copy to Camera" with a list of cameras and checkboxes:

<input type="checkbox"/> Select All
<input checked="" type="checkbox"/> D1
<input checked="" type="checkbox"/> D2
<input checked="" type="checkbox"/> D3
<input type="checkbox"/> D4
<input type="checkbox"/> D5
<input type="checkbox"/> D6
<input type="checkbox"/> D7
<input type="checkbox"/> D8
<input type="checkbox"/> D9
<input type="checkbox"/> D10

At the bottom of the dialog box are two buttons: "OK" and "Cancel".

4. Click **OK** to save the settings.

Configuring Custom Protocol

Click **Custom Protocol** to configure the protocol as follows.

The screenshot shows a 'Custom Protocol' configuration window. It contains several fields and buttons:

- Custom Protocol:** A dropdown menu with 'Custom Protocol1' selected.
- Protocol Name:** A text input field containing 'Custom 1'.
- Stream Type:** A dropdown menu with 'Main Stream' selected.
- Enable Stream:** A checked checkbox.
- Protocol:** A dropdown menu with 'RTSP' selected.
- Transfer Protocol:** A dropdown menu with 'Auto' selected.
- Port:** A text input field containing '554'.
- Stream Path:** An empty text input field.
- Buttons:** 'OK' and 'Cancel' buttons at the bottom right.

Figure 4-8 Custom Protocol

Getting Access to Parking Camera

When the camera is online, you can click **Access** and a login interface for a camera is linked. Log in to the camera to configure the parking camera parameters as follows.

The screenshot shows the 'Configuration' page of a camera's web interface. The page has a navigation bar with 'Live View', 'Playback', 'Log', and 'Configuration' (highlighted). A user 'admin' is logged in. The left sidebar shows a tree view with 'Local Configuration', 'Basic Configuration', and 'Advanced Configuration'. The main content area is titled 'Device Information' and has three tabs: 'Device Information', 'Time Settings', and 'Maintenance'. The 'Device Information' tab is active, showing a table of basic information:

Basic Information	
Device Name	IP CAMERA
Device No.	88
Model	DS-TCP135
Serial No.	DS-TCP13520150514ACCH518954651
Firmware Version	V5.2.1 build 150922
Encoding Version	V5.0 build 150921
Number of Channels	1
Number of HDDs	0
Number of Alarm Input	0
Number of Alarm Output	0

A 'Save' button is located at the bottom right of the configuration area.

Figure 4-9 Access

NOTE

You must configure the IP address of parking camera remote host and port before the parking camera data is received by the guidance terminal.

4.2.3 Configuring Camera

Configuring Display

In the Display Settings interface, you can configure the channel name and OSD settings.

Channel No.: Select the channel number from the dropdown list.

Camera Name: Customize a camera name.

OSD Settings: You can check the checkbox to display camera name, date and week information on the live view screen. You can also set the time and data format and display mode.

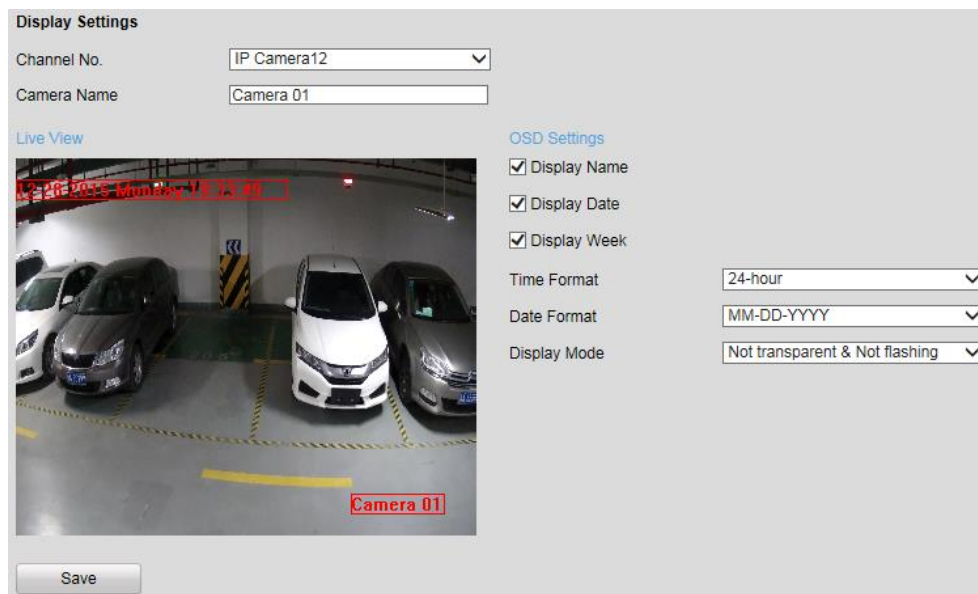


Figure 4-10 OSD Settings

NOTE

You can drag the name, date, week, time information to any position of the live view window.

Configuring Parking Space

You can configure the recognized parking space number, parking space area, and special parking space in parking space allocation.

1. Go to **Configuration > Remote Configuration > Camera Settings > Parking**

Space Settings.

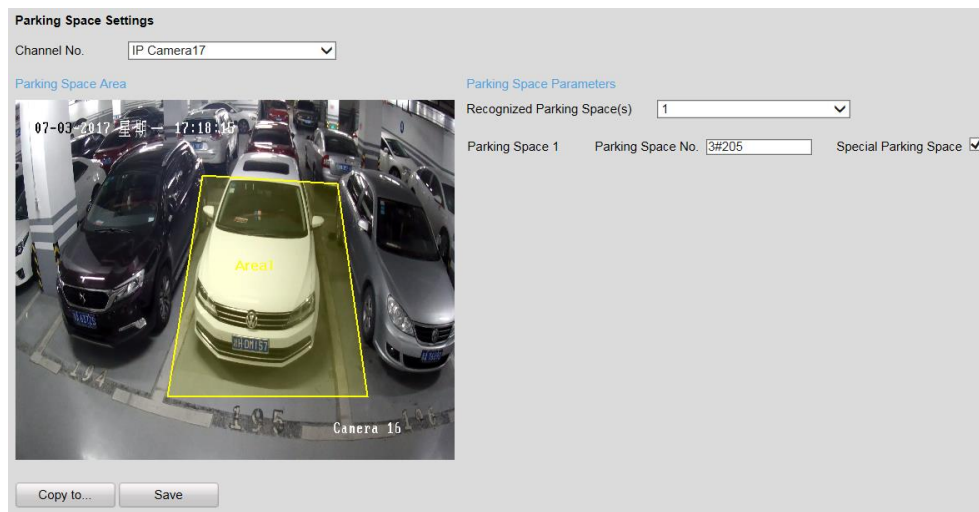


Figure 4-11 Parking Space Settings

2. Select the **Channel No.**
3. Select the number of the **Recognized Parking Space(s)** from the drop-down list.



NOTE

The selectable value may vary according the camera models.

4. Input the **Parking Space No.** in the text filed.
5. (Optional) If the space is a special space, check **Special Parking Space** checkbox.
6. Draw parking spaces.
According to the number of spaces you set, the quadrilaterals appear in the image.
 - 1) Click a quadrilateral, and drag corner of the quadrilateral to adjust the shape of it, or drag the quadrilateral to adjust the location of it.
 - 2) Repeat step 1) to configure other quadrilaterals.
7. (Optional) Click **Copy to...** to copy the settings to other cameras.
8. Click **Save** to save the settings.

Configuring Parking Space Indicator

The indicator displays the space status, different colors stand for different status. You can select the indicator and the color of different status.

Steps:

1. Go to **Configuration > Remote Configuration > Camera Settings > Parking**

Space Indicator.

2. Select the **Channel No.**
3. Select the indicator in the drop-down list of **Indicator Control Mode** on your demand, including **Internal Indicator**, **External Indicator**, and **Internal and External Indicator**.
 - If you select the **Internal Indicator** or **External Indicator**, and when all the detected parking spaces are occupied, the indicator turns to the occupied color; when the detected parking spaces are not all occupied, the indicator remains the unoccupied color.
 - If you select the **Internal and External Indicator**, the indicators work at the same time, you can respectively configure the indicator to display the status of each parking space.

Parking Space Indicator Settings			
Channel No.	IP Camera17		
Indicator Control Mode	Internal Indicator		
Parking Space Status	Enable	Indicator Flicker	Indicator Color
Unoccupied	Yes	No	Green
Occupied	Yes	No	Red
Over Line	No	No	Yellow
Special Parking Space	No	No	Blue

Buttons: Copy to..., Save

Figure 4-12 Configure Internal Indicator

Parking Space Indicator Settings			
Channel No.	IP Camera17		
Indicator Control Mode	External Indicator		
Parking Space Status	Enable	Indicator Flicker	Indicator Color
Unoccupied	Yes	No	Green
Occupied	Yes	No	Red
Over Line	No	No	Yellow
Special Parking Space	No	No	Blue

Buttons: Copy to..., Save

Figure 4-13 Configure External Indicator

Parking Space Status	Enable	Indicator Flicker	Indicator Color
Unoccupied	Yes	No	Green
Occupied	Yes	No	Red
Over Line	No	No	Yellow
Special Parking Space	No	No	Blue

Figure 4-14 Configure Internal and External Indicator

- Set the indicator parameters for different parking space status.

The description of different status is shown below:

Unoccupied: The space is free.

Occupied: The space is occupied by a vehicle.

Over Line: A vehicle occupied two parking spaces.

Special Parking Space: The space is specified to a certain vehicle.

- If you choose **Internal and External Indicator**, click the tab of the parking space No. (e.g. Parking Space 1) and select the indicator in the **Indicator Source** drop-down list.
- Configure the following parameters on your demand.

Enable: Select **Yes** or **No** to enable or disable the indication for the corresponding status.

Indicator Flicker: Set the indicator flicker or not for the corresponding status.

Indicator Color: Choose the color of the indicator for the corresponding status.

- (Optional) Click **Copy to...** to copy the settings to other cameras.
- Click **Save** to save the settings.

Configuring Capture Parameters

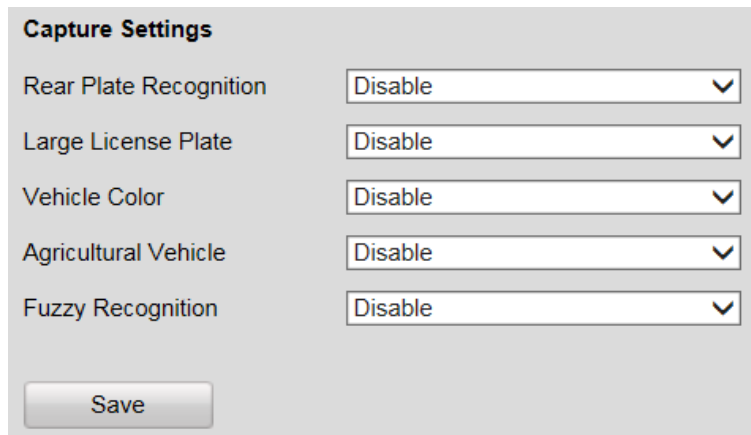
You can configure the capture parameters as below.

Steps:

- Go to **Configuration > Remote Configuration > Camera Settings > Capture**

Parameters.

2. Enable or disable the parameters as below.



Capture Settings	
Rear Plate Recognition	Disable
Large License Plate	Disable
Vehicle Color	Disable
Agricultural Vehicle	Disable
Fuzzy Recognition	Disable

Save

Figure 4-15 Configure Capture Parameters

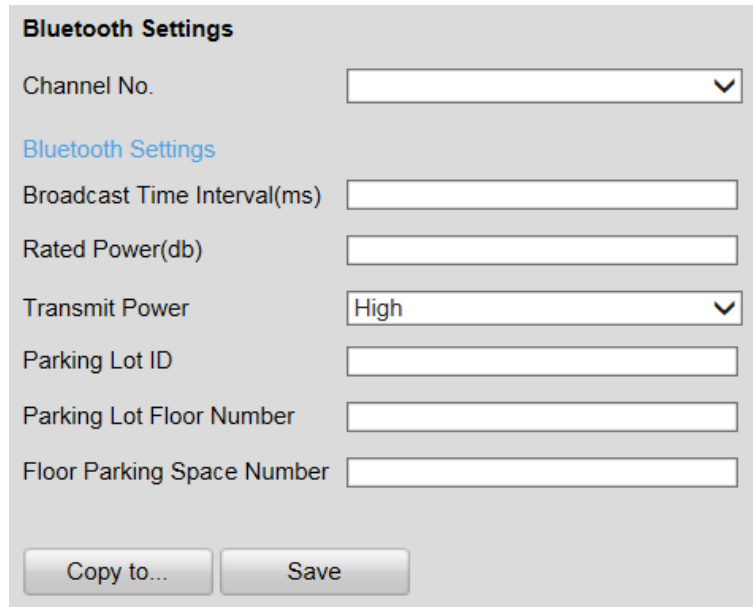
- **Rear Plate Recognition:** Enable or disable the license plate recognition when the vehicle is backed into the space.
- **Large License Plate:** Normally, the camera is recommended to be placed about 5 m away from the parking space to ensure the plate recognition accuracy. But if the parking camera is placed much nearer to the space than the recommended distance, the license plate possesses greater pixels in the image which will make it look large, then you should enable the Large License Plate function to improve the accuracy of the license plate recognition.
- **Vehicle Color:** Enable or disable vehicle color recognition.
- **Agricultural Vehicle:** For the license plate of agricultural vehicles, they are much different from other ones of normal vehicles. Enable the Agricultural Vehicle function to recognize the license plate number of agricultural vehicles.
- **Fuzzy Recognition:** Enable or disable fuzzy recognition of the license plate.

Configuring Bluetooth

If Bluetooth parking camera is connected, you can configure the Bluetooth parameters.

Steps:

1. Go to **Configuration > Remote Configuration > Camera Settings > Bluetooth Settings**.



Bluetooth Settings

Channel No.

Bluetooth Settings

Broadcast Time Interval(ms)

Rated Power(db)

Transmit Power

Parking Lot ID

Parking Lot Floor Number

Floor Parking Space Number

Figure 4-16 Bluetooth Configuration

2. Select the **Channel No.**
3. Configure the Bluetooth parameters.
 - **Broadcast Time Interval:** the frequency of sending broadcast frame by Bluetooth module.
 - **Rated Power:** the signal strength received by mobile client which is 1 meter away from the parking camera.
 - **Transmit Power:** Three levels are selectable. The stronger the transmit power, the further the receivable distance.
 - **Parking Lot ID:** Hex number can be entered (0 - F).
 - **Parking Lot Floor Number:** Configure according to the actual conditions.
 - **Floor Parking Space Number:** Configure according to the actual conditions.

Configuring Video

You can configure the video parameters in the Video Settings interface including stream type, video type, resolution, etc.

Figure 4-17 Video Settings

Parameters	Description
Channel No.	Up to 32 channels.
Stream Type	Main Stream (Normal)/Sub Stream/Main Stream (Event) are selectable.
Video Type	Video Stream
Resolution	The higher the resolution, the clearer the image, and the larger bandwidth it needs.
Bitrate Type	Variable/Constant is selectable.
Video Quality	Highest/Higher/Medium/Low/Lower/Lowest. By default, it is Medium.
Frame Rate	The higher the frame rate, the larger bandwidth it needs, and the larger storage space it needs.
Max. Bitrate	The maximum bitrate.
Video Encoding	H.264.

Configuring Schedule

You can set the record schedule in Schedule Settings interface as follows.

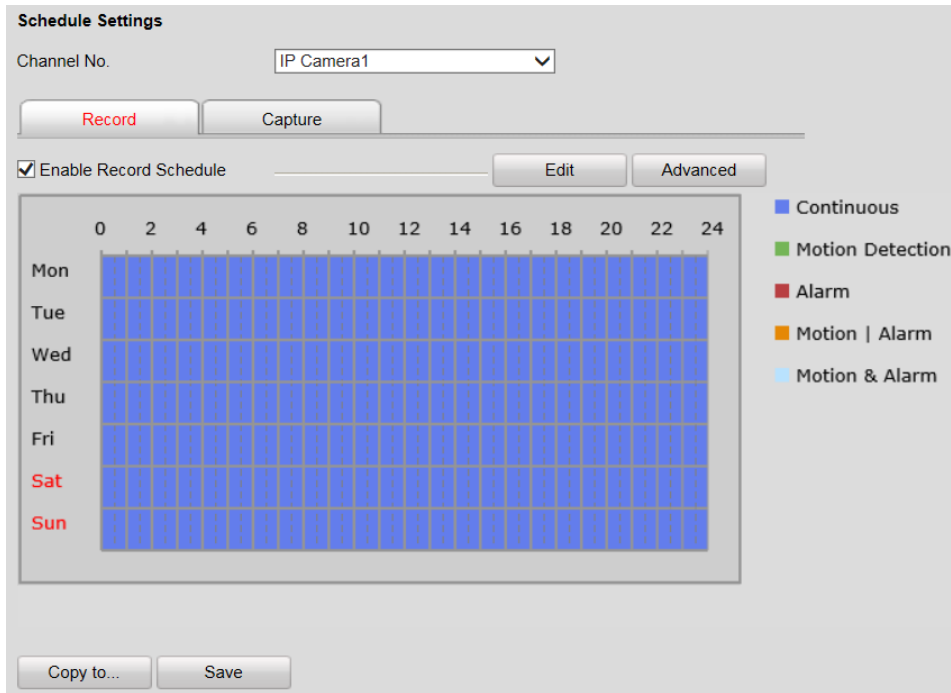


Figure 4-18 Schedule Settings

Steps:

1. Select the channel No. from the drop-down list.
2. Check the checkbox of **Enable Record Schedule**.
3. Click **Edit** to set the schedule as follows.

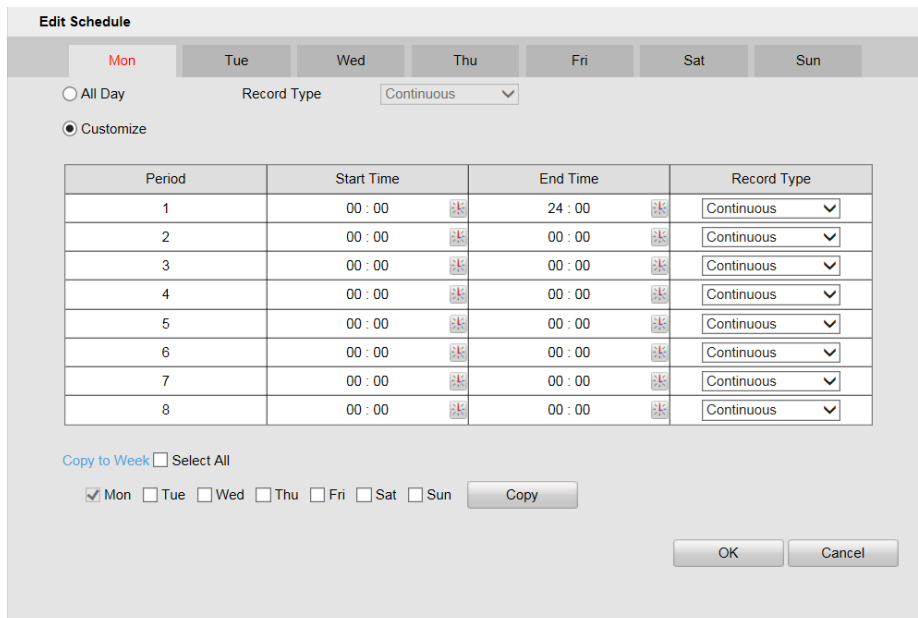

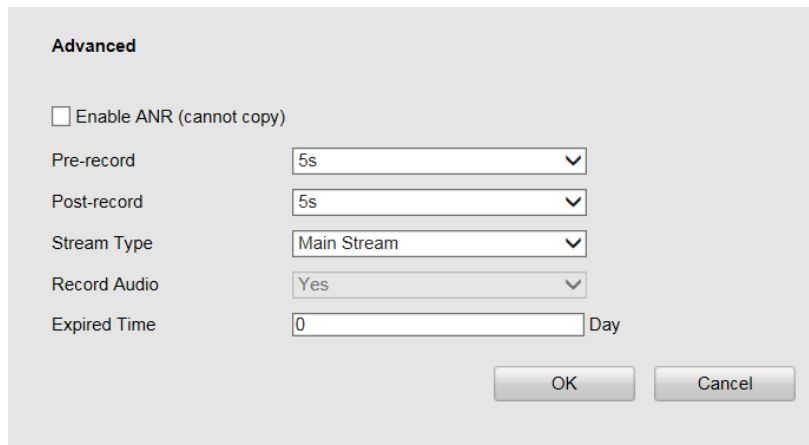


Figure 4-19 Edit Schedule

- 1) Select **All Day** or **Customize** to edit the schedule.
- 2) Select the **Record Type**. Continuous, Motion Detection, Alarm, Motion or

Alarm and Motion & Alarm are selectable.

- 3) If you select **Customize**, click  to set the start time and end time.
 - 4) (Optional) If you want to copy the settings to other days, check the checkbox and click **Copy**.
 - 5) Click **OK** to save the settings.
4. Click **Advanced** in Schedule Settings interface to configure advanced settings as follows.



Advanced	
<input type="checkbox"/> Enable ANR (cannot copy)	
Pre-record	5s
Post-record	5s
Stream Type	Main Stream
Record Audio	Yes
Expired Time	0 Day
<input type="button" value="OK"/> <input type="button" value="Cancel"/>	

Figure 4-20 Advanced Settings

5. (Optional) If you want to copy all the settings to other channels, click **Copy to...** and select channels, and then click **OK**.
6. Click **Save** to save the settings.

Configuring Snapshot

You can configure the scheduled snapshot and event-triggered snapshot parameters including format, resolution, quality and interval.

Snapshot

Channel No. IP Camera1

Timing

Format JPEG

Resolution 704*576

Quality Medium

Interval 2 second

Event-Triggered

Format JPEG

Resolution 704*576

Quality Medium

Interval 2 second

Save

Figure 4-21 Snapshot Settings

4.2.4 Configuring Network

The guidance terminal is equipped with two network interface cards and you can configure extranet and intranet parameters respectively.

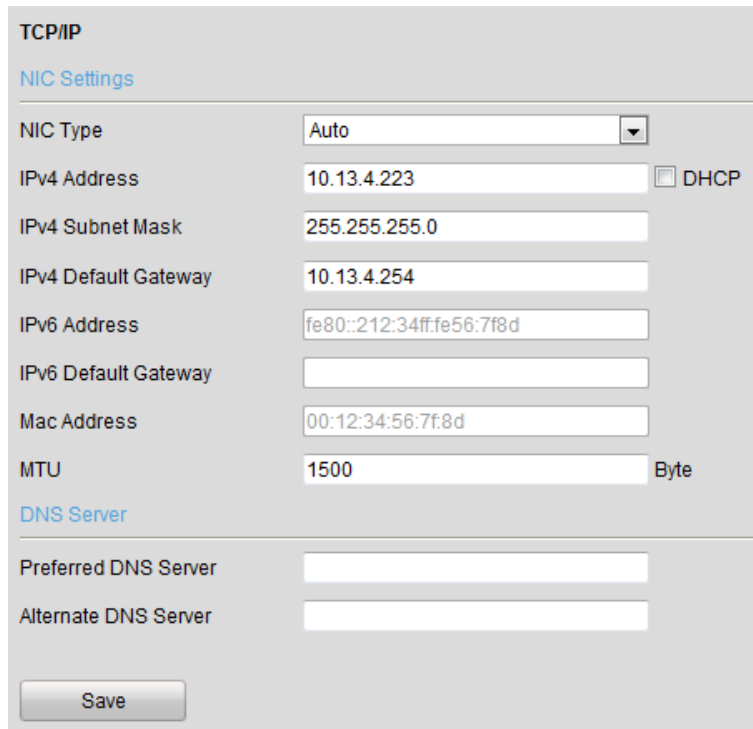
Configuring TCP/IP

You can configure the IP address of the four 1000M network interface cards.

NIC Type: Auto, 10M Half-dup, 10M Full-dup, 100M Half-dup and 100M Full-dup is selectable.

The default IP address is 192.0.0.64, which is used to interact with back-end platform.

IP address, subnet mask and gateway can be configured in the following interface.



The screenshot shows a configuration window titled "TCP/IP" with a sub-section "NIC Settings". The settings are as follows:

Field	Value
NIC Type	Auto
IPv4 Address	10.13.4.223
IPv4 Subnet Mask	255.255.255.0
IPv4 Default Gateway	10.13.4.254
IPv6 Address	fe80::212:34ff:fe56:7f8d
IPv6 Default Gateway	
Mac Address	00:12:34:56:7f:8d
MTU	1500

Below the NIC settings is a "DNS Server" section with two empty input fields for "Preferred DNS Server" and "Alternate DNS Server". A "Save" button is located at the bottom left of the window.

Figure 4-22 TCP/IP Settings

 **NOTE**

- **MTU:** The maximum size of data packet in transmission.
- You are required to reboot the guidance terminal after modifying the IP address.

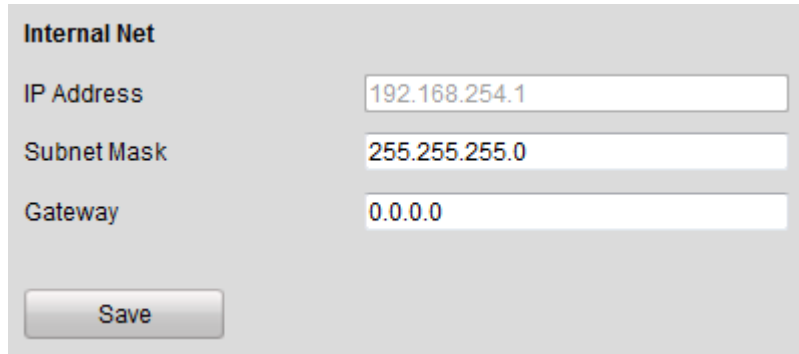
Configuring Internal Net

You can view IP Address and modify subnet mask and gateway of the 16 100M network interface cards in the following interface.

The default IP address is 192.168.254.1. The 16 network interface cards are in the same network segment, which can interact with cameras and up to 32 parking cameras can be accessed.

 **NOTE**

Network segment: 192.168.254.2~192.168.254.33. Other IP address cannot access to the guidance terminal.

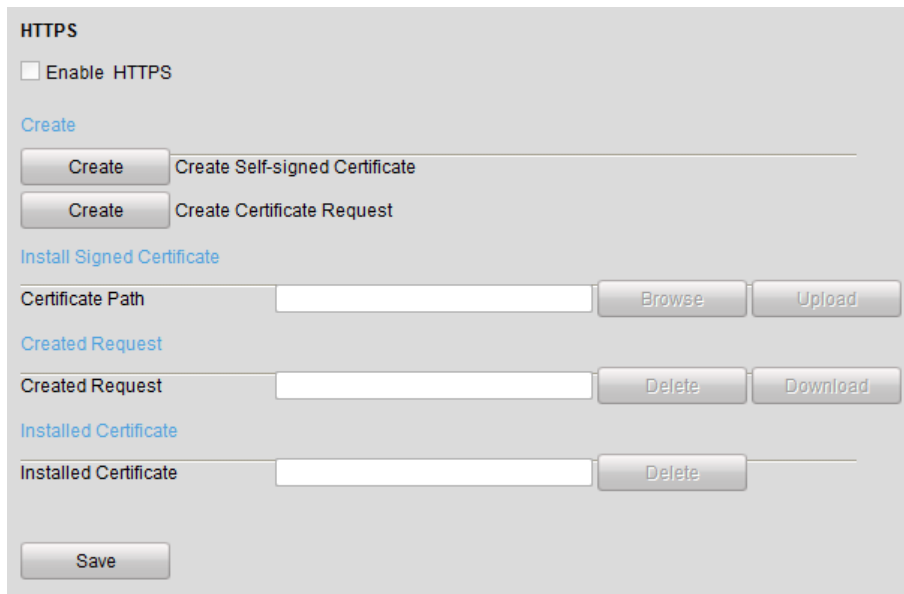


The screenshot shows a configuration window titled "Internal Net". It contains three input fields: "IP Address" with the value "192.168.254.1", "Subnet Mask" with "255.255.255.0", and "Gateway" with "0.0.0.0". Below these fields is a "Save" button.

Figure 4-23 Internal Net Settings

Configuring HTTPS

You can check the checkbox to enable HTTPS in the HTTPS interface and create self-signed certificate, certificate request and upload, download and delete certificate.

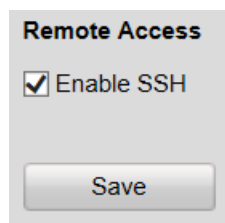


The screenshot shows a configuration window titled "HTTPS". It features a checkbox labeled "Enable HTTPS" which is currently unchecked. Below this, there are three sections: "Create" with buttons for "Create Self-signed Certificate" and "Create Certificate Request"; "Install Signed Certificate" with a "Certificate Path" field, "Browse" and "Upload" buttons; and "Created Request" with a "Created Request" field, "Delete" and "Download" buttons. There is also an "Installed Certificate" section with an "Installed Certificate" field and a "Delete" button. A "Save" button is located at the bottom of the form.

Figure 4-24 HTTP Settings

Configuring Remote Access

You can check the checkbox to enable SSH in Remote Access interface.



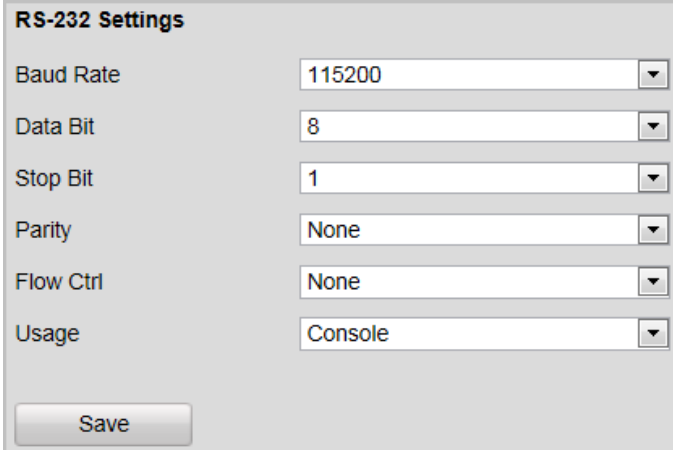
The screenshot shows a configuration window titled "Remote Access". It contains a checkbox labeled "Enable SSH" which is checked. Below the checkbox is a "Save" button.

Figure 4-25 Remote Access Settings

4.2.5 Configuring Serial Port

Configuring RS-232 Serial Port

RS-232 serial port parameters are for the RS-232 interface. Please keep the settings as default.

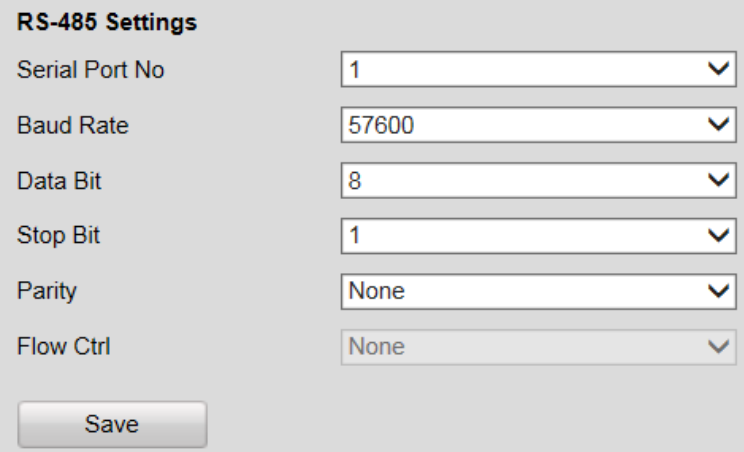


The screenshot shows a dialog box titled "RS-232 Settings". It contains six dropdown menus: Baud Rate (115200), Data Bit (8), Stop Bit (1), Parity (None), Flow Ctrl (None), and Usage (Console). A "Save" button is located at the bottom left of the dialog.

Figure 4-26 RS-232 Settings

Configuring RS-485 Serial Port

RS-485 serial port is used for connecting to LED display units, which shows the available parking spaces and the direction of the parking area.



The screenshot shows a dialog box titled "RS-485 Settings". It contains six dropdown menus: Serial Port No (1), Baud Rate (57600), Data Bit (8), Stop Bit (1), Parity (None), and Flow Ctrl (None). A "Save" button is located at the bottom left of the dialog.

Figure 4-27 RS-485 Settings

4.2.6 Configuring Alarm

Configuring Alarm Input

Steps:

1. Select the **Alarm Input No.** from the drop-down list.
2. Select **Alarm Type** as **NO** (Remain Open) or **NC** (Remain Closed).
3. Enter the **Alarm Name**.
4. Check **Enable** to enable the alarm input.
5. Click **Arming Schedule** tab to set the schedule.

Alarm Input Settings

Alarm Input No. A<-1 IP Address Local

Alarm Type NO Alarm Name (cannot copy)

Enable

Arming Schedule Linkage Method

Edit

	0	2	4	6	8	10	12	14	16	18	20	22	24
Mon	Blue	Blue	Blue	Blue	Blue	Blue	Blue	Blue	Blue	Blue	Blue	Blue	Blue
Tue	Blue	Blue	Blue	Blue	Blue	Blue	Blue	Blue	Blue	Blue	Blue	Blue	Blue
Wed	Blue	Blue	Blue	Blue	Blue	Blue	Blue	Blue	Blue	Blue	Blue	Blue	Blue
Thu	Blue	Blue	Blue	Blue	Blue	Blue	Blue	Blue	Blue	Blue	Blue	Blue	Blue
Fri	Blue	Blue	Blue	Blue	Blue	Blue	Blue	Blue	Blue	Blue	Blue	Blue	Blue
Sat	Blue	Blue	Blue	Blue	Blue	Blue	Blue	Blue	Blue	Blue	Blue	Blue	Blue
Sun	Blue	Blue	Blue	Blue	Blue	Blue	Blue	Blue	Blue	Blue	Blue	Blue	Blue

Copy to... Save

Figure 4-28 Alarm Input

6. Click **Edit** to edit the arming schedule time.

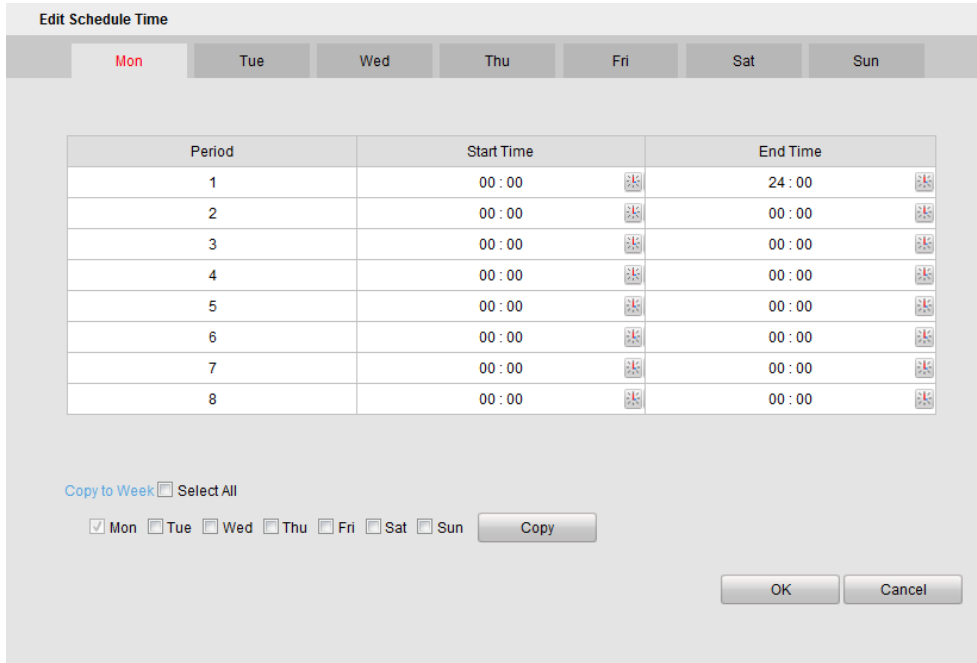


Figure 4-29 Edit Schedule Time

7. Click **Linkage Method** tab to set the parameters of Normal Linkage, Trigger Alarm Output, and Trigger Channel.

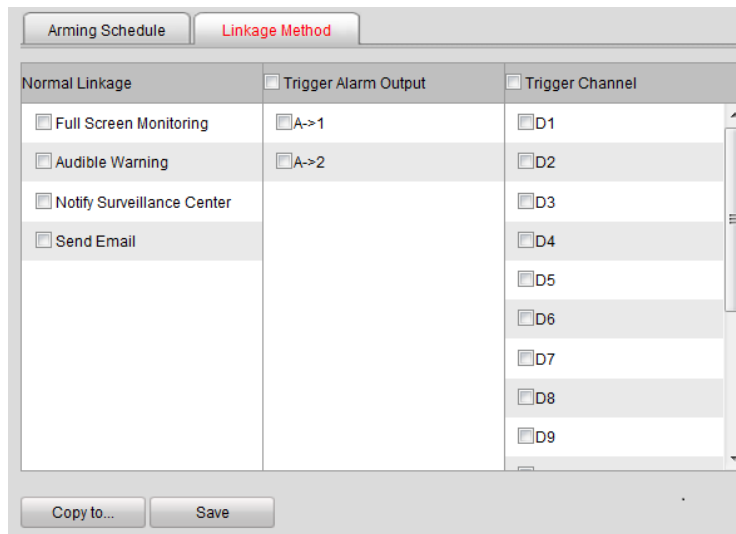


Figure 4-30 Linkage Method

Configuring Alarm Output

Refer to the above section **Alarm Input** for detailed steps.

Alarm Output Settings

Alarm Output: A->1 | IP Address: Local

Default Status: Low Level | Triggering Status: Pulse

Delay: 5s | Alarm Name: (cannot copy)

Arming Schedule

0 2 4 6 8 10 12 14 16 18 20 22 24

Mon	Active
Tue	Active
Wed	Active
Thu	Active
Fri	Active
Sat	Active
Sun	Active

Buttons: Copy to..., Save, Edit

Figure 4-31 Alarm Output

Configuring Voice Alarm

Steps:

1. Enter the Voice Alarm Configuration interface.

Voice Alarm Configuration

Buttons: Add, Modify, Delete

Serial No.	Voice Alarm Type	Voice Alarm Priority	Voice Alarm Times	Enable Voice Alarm
<input type="checkbox"/> A02	Space Crossed	High	1	On

Figure 4-32 Voice Alarm Configuration

2. Click **Add** to add voice alarm.

Voice Alarm Configuration

Voice Alarm Type: Multi-Spaces Occupied

Voice Alarm Priority: High

Voice Alarm Times: 1

Enable Voice Alarm: ON

Buttons: OK, Back

Figure 4-33 Add Voice Alarm

3. Select Voice Alarm Type, Voice Alarm Priority and Voice Alarm Times from the drop-down lists, and select Enable Voice Alarm as **ON**.
4. Click **OK** to save the settings.

4.2.7 Controlling Indicator

Configuring Opposite Space Detection

The opposite space detection is applicable to the parking lot that the aisle between the opposite parking spaces is very narrow. After you configure the function, the indicator of the current parking camera displays the status of opposite space, and vice versa.



NOTE

The parking space indicator configuration of two cameras for opposite space detection must be the same.

Opposite Space Detection Settings

Channel No.	IP Channel Address	Status
<input checked="" type="checkbox"/> D01	192.168.254.2	Online
<input type="checkbox"/> D02	192.168.254.3	Online
<input type="checkbox"/> D03	192.168.254.4	Offline
<input type="checkbox"/> D04	192.168.254.5	Online
<input type="checkbox"/> D05	192.168.254.6	Online
<input type="checkbox"/> D06	192.168.254.7	Online
<input type="checkbox"/> D07	192.168.254.8	Online
<input type="checkbox"/> D08	192.168.254.9	Offline
<input type="checkbox"/> D09	192.168.254.10	Online
<input type="checkbox"/> D10	192.168.254.11	Online
<input type="checkbox"/> D11	192.168.254.12	Offline
<input type="checkbox"/> D12	192.168.254.13	Online
<input type="checkbox"/> D13	192.168.254.14	Online
<input type="checkbox"/> D14	192.168.254.15	Online
<input type="checkbox"/> D15	192.168.254.16	Online
<input type="checkbox"/> D16	192.168.254.17	Online
<input type="checkbox"/> D17	192.168.254.18	Online
<input type="checkbox"/> D18	192.168.254.19	Online
<input type="checkbox"/> D19	192.168.254.20	Online
<input type="checkbox"/> D20	192.168.254.21	Online
<input type="checkbox"/> D22	192.168.254.23	Online
<input type="checkbox"/> D23	192.168.254.24	Online
<input type="checkbox"/> D24	192.168.254.25	Online
<input type="checkbox"/> D25	192.168.254.26	Online
<input type="checkbox"/> D26	192.168.254.27	Online
<input type="checkbox"/> D27	192.168.254.28	Online
<input type="checkbox"/> D28	192.168.254.29	Online
<input type="checkbox"/> D29	192.168.254.30	Online

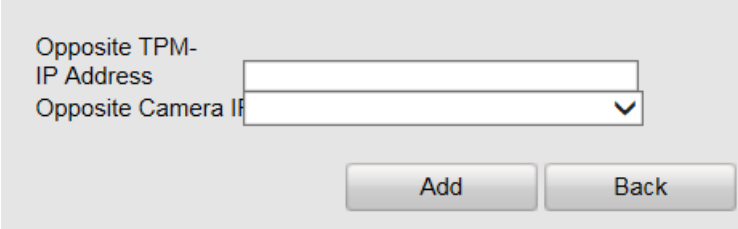
<input type="checkbox"/> Channel No.	IP Channel Address	Status	Opposite TPM-IP Address	Opposite Camera IP Address
<input checked="" type="checkbox"/> D20	192.168.254.21	Online	10.96.19.244	192.168.254.22
<input type="checkbox"/> D21	192.168.254.22	Offline	10.96.19.244	192.168.254.21

Figure 4-34 Opposite Space Detection Settings

Steps:

1. Check two cameras for opposite space detection.
2. Click **Add** to set the selected two cameras to detect the opposite parking space.

If the camera needs to detect the parking space of another camera under other guidance terminal, select the camera and click **Add Across TPM**.



Opposite TPM-IP Address
Opposite Camera IP Address

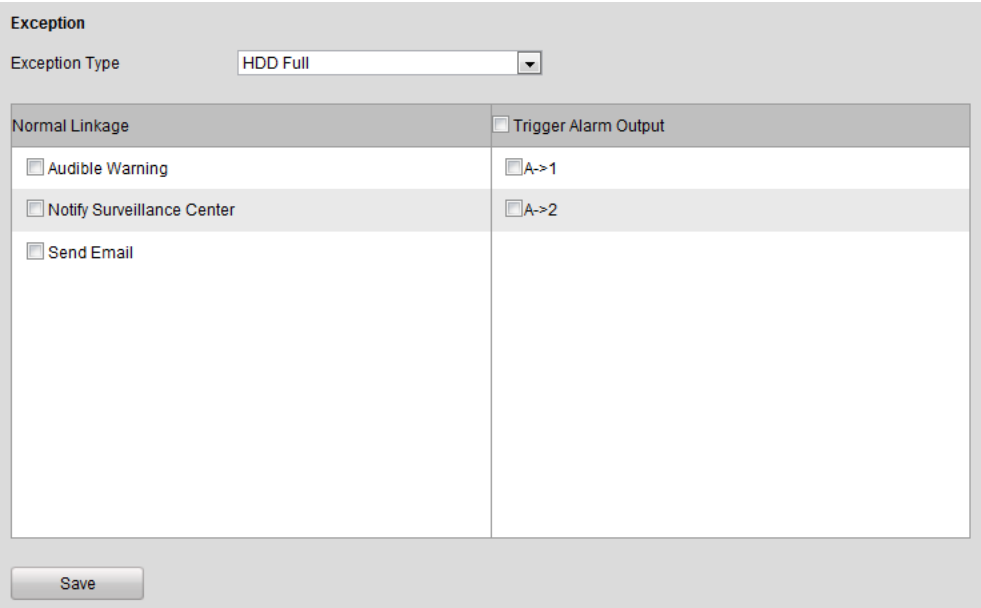
Add Back

Figure 4-35 Add Across TPM

3. Enter **Opposite TPM-IP Address** and select **Opposite Camera IP Address**.
 - Opposite TPM is another guidance terminal which needs to be controlled.
 - Opposite camera is another parking camera which needs to be controlled.
4. Click **Add** to save the settings.

4.2.8 Configuring Exception

You can set the alarm output method when exception happens. Exception type includes HDD Full, HDD Error, Network Disconnected, IP Address Conflicted, Illegal Login and Record/Capture Exception. The alarm output method includes Normal Linkage (Audible Warning, Notify Surveillance Center and Send Email) and Trigger Alarm Output.



Exception

Exception Type: HDD Full

Normal Linkage	Trigger Alarm Output
<input type="checkbox"/> Audible Warning	<input type="checkbox"/> A->1
<input type="checkbox"/> Notify Surveillance Center	<input type="checkbox"/> A->2
<input type="checkbox"/> Send Email	

Save

Figure 4-36 Exception

Refer to the following descriptions of Exception Type.

Exception Type	Description
HDD Full	All the HDD space is full.
HDD Error	Error when writing in the HDD or the HDD is not initialize.
Network Disconnected	The network is not connected.
IP Address Conflicted	IP addresses are conflicted.
Illegal Login	Wrong password.
Record/Capture Exception	Exception of record or capture.

4.2.9 Managing User

You can add, modify and delete users and set user permission in User Management interface.

By default, there is only one user account **admin** and the level is Administrator.

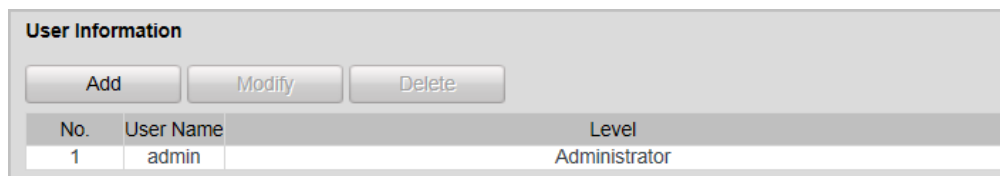


Figure 4-37 User Management

Adding a User

Steps:

1. Click **Add** in the User Management interface.
2. Enter the **User Name** and **Password** as desired.



STRONG PASSWORD RECOMMENDED– We highly recommend you create a strong password of your own choosing (using a minimum of 8 characters, and contains at least three kinds of following categories: upper case letters, lower case

letters, numbers, and special characters) in order to increase the security of your product.

3. Select the level as **Operator** or **User**.
4. Confirm the password.
5. Select the user permission including **Basic Permission** and **Camera Configuration Permission** by checking the checkbox.

Add user

User Name

Level

Password

Confirm

Valid password range: 8 to 16 characters. You can use a combination of numbers, lowercase, uppercase and special character for your password with at least two kinds of them contained.

Basic Permission Camera Configuration

Local: Configuration

- Local: Upgrade/Format
- Local: Shutdown/Reboot
- Local: Parameters Settings
- Local: Log Search

Remote: Configuration

- Remote: Parameters Settings
- Remote: Log Search / Interrogate Working Status
- Remote: Upgrade / Format
- Remote: Two-way Audio
- Remote: Shutdown / Reboot
- Remote: Notify Surveillance Center / Trigger Alarm Output
- Remote: Video Output Control
- Remote: Serial Port Control
- Remote: Camera Management

OK Back

Figure 4-38 Add a User

6. Click **OK** to save the settings.

Modifying a User

Steps:

1. Select the user account for modifying and click **Modify**.
2. You can modify the user name, password, level and permission.

NOTE

- For **admin** account, you can only modify the password.
 - We recommend you to use strong password for security purpose.
3. Click **OK** to save the settings.

Deleting a User

Select the user account for deleting and click **Delete**.



You cannot delete the **admin** account.

4.2.10 Managing HDD

The device supports HDD management for the purpose of stable and reliable storage.

Configuring Basic Settings

Steps:

1. You can select the HDD No. and set the property as R/W, Read-only or Redundancy.
2. Click **Set** to save the settings.
3. (Optional) Select the HDD in the list and click **Format** to initialize the selected HDD.



Initialization removes all the data saved in the HDD.

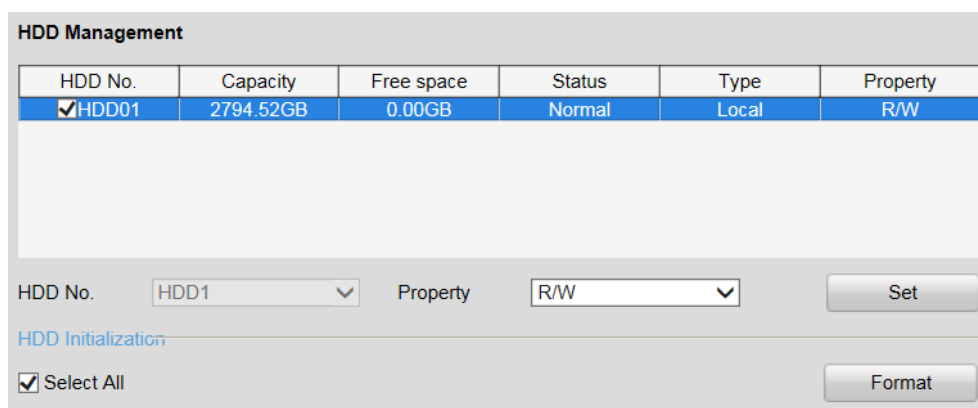


Figure 4-39 HDD Management Interface

Configuring Picture Quota

You can set the space of the picture by setting **Picture Quota**, and the rest space will

be used to save the record files.

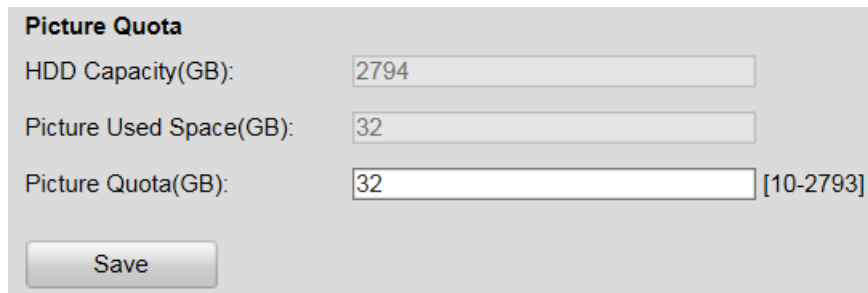


Figure 4-40 Quota Allocation

4.2.11 Running Log

Running log is used for the research and development personnel to debug the device.

Steps:

1. Check **Enable Log**. Then the log will be saved as file to save in the guidance terminal.
2. Check **Overwrite File**.
3. (Optional) Check **Enable by Period** and set the time period for saving the log.
4. Click **Save** to save the settings.
5. (Optional) Click **Export** to export the log or click **Delete** to delete the log.

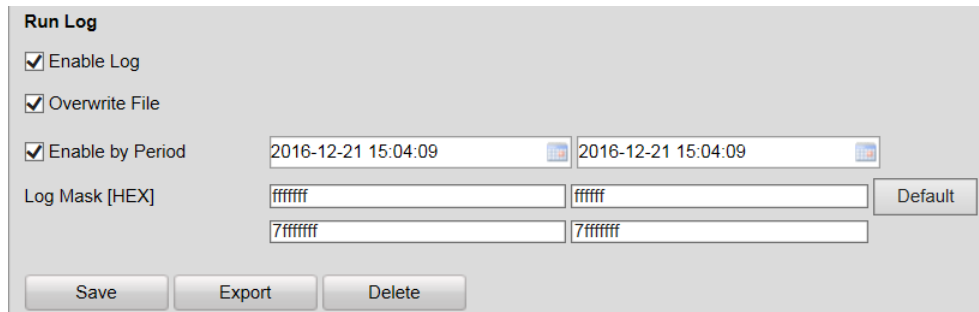


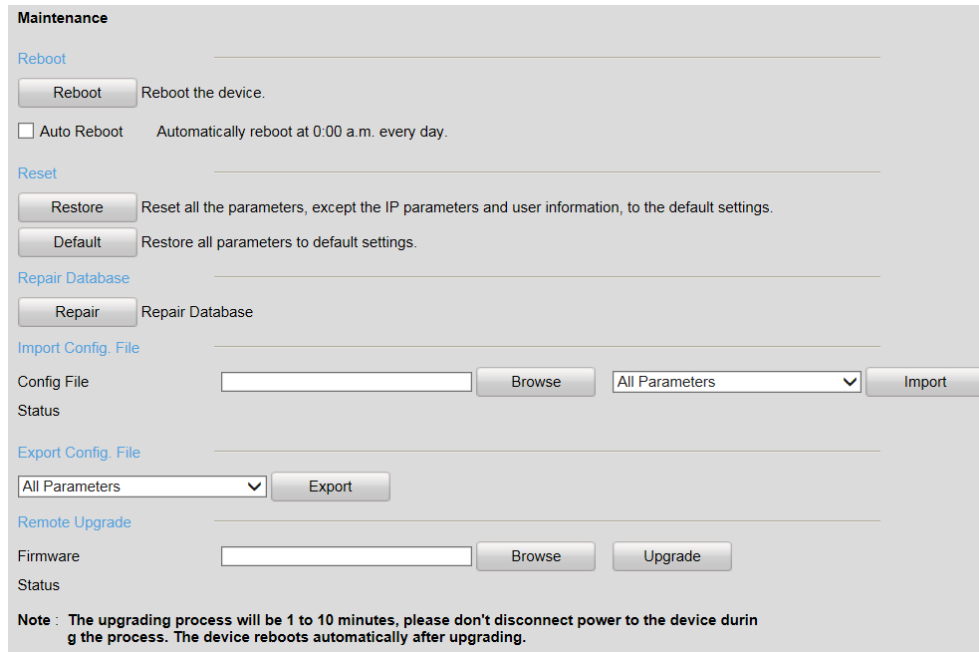
Figure 4-41 Run Log

NOTE

The log mask is the module of printing log. The default log mask is to print error information.

4.2.12 Maintenance

You can operate some maintenance functions in Maintenance interface including Reboot, Reset, etc.



Maintenance

Reboot

Reboot the device.

Auto Reboot Automatically reboot at 0:00 a.m. every day.

Reset

Reset all the parameters, except the IP parameters and user information, to the default settings.

Restore all parameters to default settings.

Repair Database

Repair Database

Import Config. File

Config File All Parameters

Status

Export Config. File

All Parameters

Remote Upgrade

Firmware

Status

Note: The upgrading process will be 1 to 10 minutes, please don't disconnect power to the device during the process. The device reboots automatically after upgrading.

Figure 4-42 Maintenance



- The upgrading file is digicap.dav.
- The upgrading process will be 1 to 10 minutes. Please do not disconnect power to the device during the process.
- The device will reboot automatically after upgrading.

4.2.13 Connecting to Platform

The guidance terminal can connect to Ehome and Hik-Connect.

Accessing to Ehome

The guidance terminal can connect to Ehome to realize real-time monitoring, transmission, storage, management, etc. via network.

Steps:

1. Go to **Configuration > Remote Configuration > Platform Settings**.
2. Check **Enable** checkbox.
3. Select the **Platform Access Mode** as **Ehome**.

Ehome V2.1-3.0, PU V2.0.0

Enable

Platform Access Mode: Ehome

Server IP: 192.0.7.166

Server Port: 7660

PUID: A331

Register Status: offline

Save

Figure 4-43 Get Access to Ehome

4. Enter the **Server IP**, **Server Port**, and **PUID**.
5. Click **Save** to save the settings.
6. Reboot the guidance terminal to take the settings into effect. Then you can view the Register Status to see if the terminal is accessed to Ehome successfully.

Accessing to Hik-Connect

Hik-Connect is a micro-video service platform. The guidance terminal can connect to Hik-Connect to realize video/audio on demand, playback, etc.

Steps:

1. Go to **Configuration > Remote Configuration > Platform Settings**.
2. Check **Enable** checkbox.
3. Select the **Platform Access Mode** as **Hik-Connect**.

ezviz

Enable

Platform Access Mode: Hik-Connect

Register Status: offline

Save

Figure 4-44 Get Access to Hik-Connect

4. Click **Save** to save the settings.

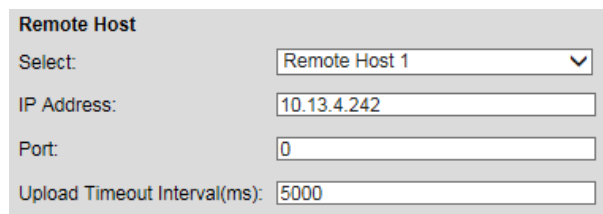
5. Reboot the guidance terminal to take the settings into effect. Then you can view the **Register Status** to see if the terminal is accessed to Hik-Connect successfully. If the status is online, register the Hik-Connect account, and add the terminal to Hik-Connect.

4.2.14 Configuring Remote Host

You can set the remote host parameters for the data uploading in the Remote Host interface.

Steps:

1. Select the remote host from the drop-down list.
2. Enter the **IP Address**, **Port** and **Uploading Timeout Interval**.
3. Click **Save** to save the settings.



Remote Host	
Select:	Remote Host 1
IP Address:	10.13.4.242
Port:	0
Upload Timeout Interval(ms):	5000

Figure 4-45 Remote Host

4.2.15 Viewing Status

You can view the system status in Status interface.

Viewing Network Uploading Status

You can view the network uploading status to find out if the remote host is enabled. If the status is **Disable**, you should check if the IP address and other parameters are correctly configured in Remote Host interface.

Network Uploading Status		
Host Name	Switch	Connection Status
Remote Host 1	Enable	Normal
Remote Host 2	Disable	

Figure 4-46 Uploading Status

Viewing Working Status




You can view the system time and working time in Working Status interface.

Working Status	
System Time	2017-06-26 16:40:19 + 08:00
Working Time	4day 8min 17s

Figure 4-47 Working Status

Chapter 5 Live View

Steps:

1. Open the Live View page.
2. (Optional) Click the  icon in the live view toolbar, and select the screen layout mode.
3. Double-click the camera name after selecting the display window to start the live view.
Or you can click  before the camera name to start the live view.
4. (Optional) Click  before the camera name to select the main stream or sub stream.

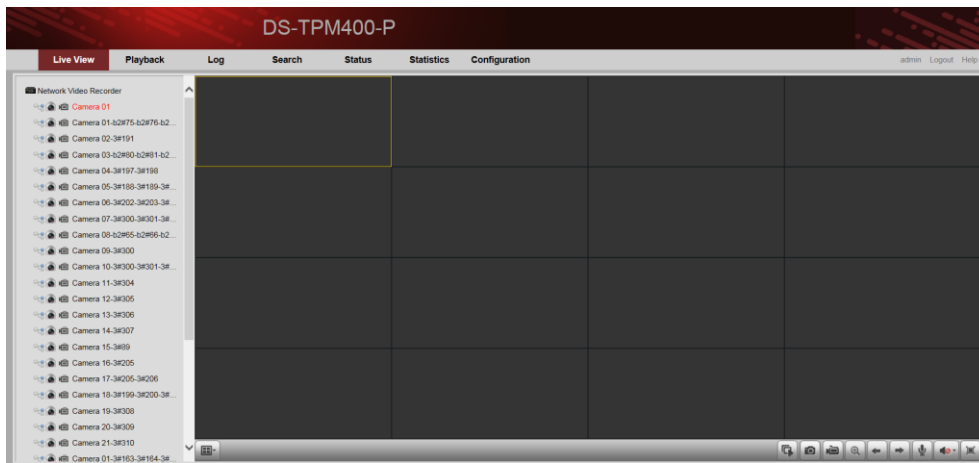





Figure 5-1 Live View Interface

Live View Toolbar:









Figure 5-2 Toolbar

On the Live View page, the following toolbar buttons are available:

Icon	Name	Description
	Set View	Set the screen layout mode. 4 types of screen layout modes are selectable: 1-Screen, 4-Screen, 9-Screen and 16-Screen.
	Start All Live View	Start the live view of all cameras.
	Capture	Capture the picture in the live view process.

Guidance Terminal User Manual

	Start All Recording	Start the recording of all cameras.
	Prev Page	Go for live view of the previous page.
	Next Page	Go for live view of the next page.
	Start Two-way Audio	Enable the two-way audio.
	Audio On/Audio Off	Turn on/off the audio in live view
	Full Screen	Display the live view in full screen mode. Press ESC to exit.

Chapter 6 Playback

Purpose:

The record files stored on the HDDs on the local device can be searched and played back remotely through the web browser.

Click the **Playback** tab to enter the Playback interface.

6.1 Playback Interface

The Playback interface is shown as follows.



Figure 6-1 Playback Interface

Playback Toolbar:











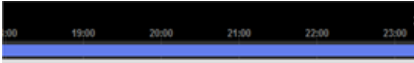
Figure 6-2 Playback Toolbar


On the Playback page, the following toolbar buttons are available:

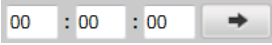

Table 6-1 Toolbar Description

Icon	Name	Description
	Set View	Set the screen layout mode. 4 types of screen layout modes are selectable: 1-Screen, 4-Screen, 9-Screen and 16-Screen.
	Stop Playback	Stop the playback of the record files.
	Slow Forward	Decrease the playback speed of the record files.

Icon	Name	Description
	Fast Forward	Increase the playback speed of the record files.
	Single Frame	Play back the record files frame by frame.
	Stop All Playback	Stop the playback of all the cameras.
	Capture	Capture the picture in the playback process.
	Download	Download the record file for backup.
	Start/Stop Clipping	Start/Stop clipping the record files.
	Audio On/Audio Off	Turn on/off the audio in live view
	Full Screen	Display the playback in full screen mode. Press ESC to exit.

Click on the  to select the time and play the record.

You can click  to zoom out or zoom in on the timeline.

You can input the time in the  and click  to go to the specified time to view the record.

6.2 Searching Record Files

Steps:

1. Open the Playback page.
2. Select the cameras to be searched from the list.
3. Select the date on the calendar for the search.
4. Click **Search**.

Chapter 7 Log

Purpose:

You can view and export the log files at any time, including operation, alarm, exception and information of device.

Before you start:

The Log function can be realized only when the device is connected with HDD or network disk.

Click **Log** tab to enter the Log interface.

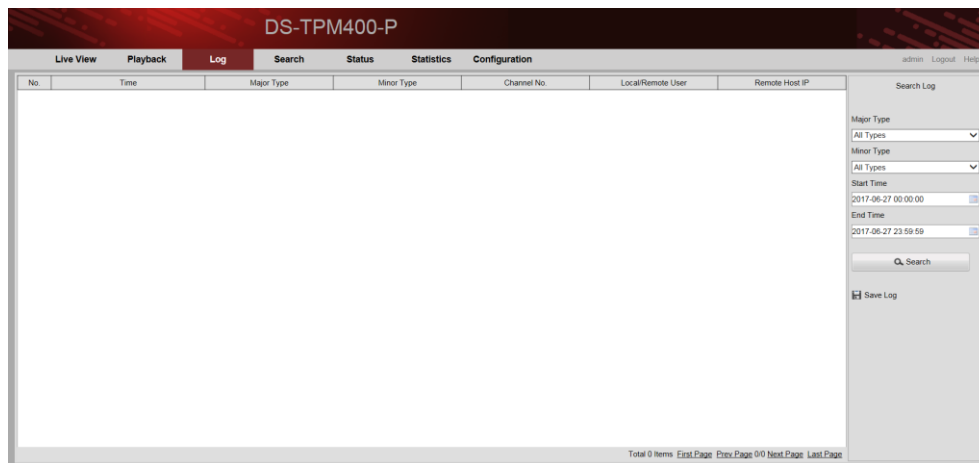



Figure 7-1 Log Interface

7.1 Searching Log Files

Steps:

1. Open the Log Search page.
2. Select the **Major Type**. There are four major types, including **Alarm**, **Exception**, **Operation** and **Information**. You can also select **All Types** to search all types of the log.
3. Select the **Minor Type**.
4. Click  to specify the **Start Time** and **End Time**.
5. Click **Search**. The log files between the start time and end time will be displayed on the list.

6. (Optional) You can click  to save the searched logs.

 **NOTE**

Please narrow the time range or filter the log type for search if there are too many log files.

Chapter 8 Data Search

Purpose:

You can search the data such as the license plate number, parking space number, etc. by specifying the search condition in Search interface.

Click the **Search** tab to enter the Search interface.

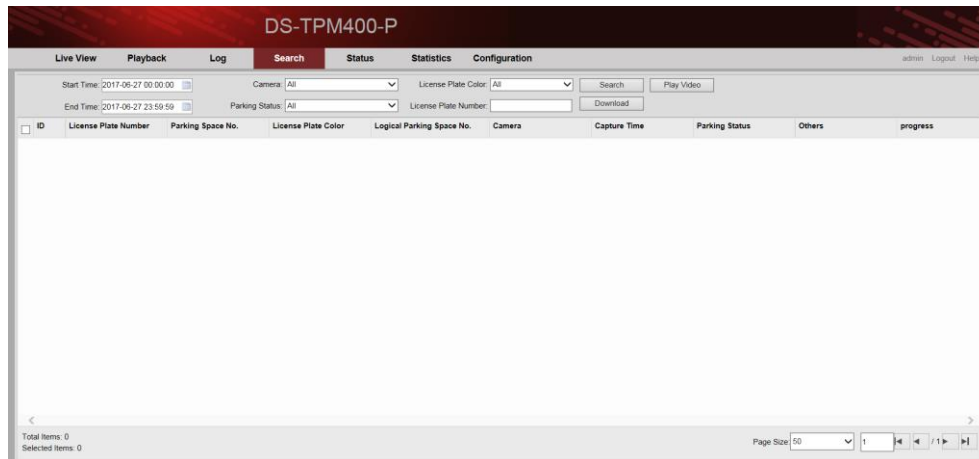




Figure 8-1 Search Interface

Steps:

1. Click  to specify the **Start Time** and **End Time**.

NOTE

- When inputting the time, you can click  for quick selection.
 - Time range cannot exceed 7 days.
2. Select the **Camera** from the drop-down list.
 3. Select **Parking Status** from the drop-down list.
 4. Select **License Plate Color** from the drop-down list.
 5. (Optional) You can enter the **License Plate Number** for detailed search.
 6. Click **Search**.

Chapter 9 Status

Purpose:

You can view the status of the current working cameras as well as the parking space status.

Click **Status** tab to enter the Status interface.

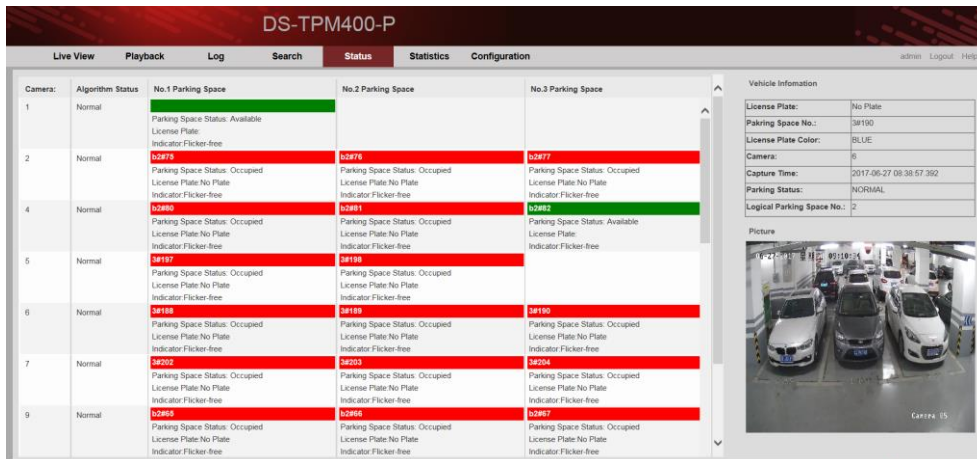


Figure 9-1 Status Interface

You can view the camera working status, the parking space information including parking space status, liscence plate, etc.

NOTE

- There are two colors of the parking space box. Green means the parking space is free. Red means the parking space is occupied.
- If the colour of parking space box on the interface and the colour of the parking space light is the same, the parking space is occupied by a car.
- Every camera has three parking space lights and every light is related to one parking space. If only one light is connected to the camera, other two parking spaces are free.
- If the parking space box on the interface is coloured, click it and you can view vehicle information and picture on the right part of the interface as follows.

Vehicle Information

License Plate:	No Plate
Parking Space No.:	3#190
License Plate Color:	BLUE
Camera:	6
Capture Time:	2017-06-27 08:38:57.392
Parking Status:	NORMAL
Logical Parking Space No.:	2

Picture



06-27-2017 09:10:34

Camera 05

Figure 9-2 Vehicle Information

Chapter 10 Statistics

Purpose:

You can view the statistics of parking space information and LED guidance screen information in Statistics interface.

Click **Statistics** tab to enter the Statistics interface.

10.1 Viewing Parking Space Information

You can view all the parking space information in **Parking Space Information** tab. Or you can input the following search condition and click **Search** to search the specified parking space.



NOTE

Parking spaces may include local parking spaces or other parking spaces on the guidance terminal. This interface shows offline statistics.

- LED ID: LED ID is the index of external LED.
- Direction: Every LED may access to multiple directions.
- Area ID: The area is related to every direction and contains multiple parking spaces.
- Parking Space Status: Camera offline and network exception may cause parking space unknown.
- Parking Space Type: Camera offline and network exception may cause parking space unknown.
- Parking Space No.: Parking space information can be searched according to parking space number.

No.	Serial No.	Area ID	Parking Space No.	License Plate	Parking Space Type	Parking Space Status	Update Time	TPM IP Address	Camera	Logical Parking Space No.
25	37	17	25		Local Parking Space	Available	2015-12-25 17:09:58	127.0.0.1	14	2
26	38	17	26		Local Parking Space	Available	2015-12-25 17:09:52	127.0.0.1	15	0
27	39	17	27		Local Parking Space	Available	2015-12-25 17:09:53	127.0.0.1	15	1
28	40	17	28		Local Parking Space	Available	2015-12-25 17:09:53	127.0.0.1	15	2
29	41	17	29		Unknown	Unknown			0	0
30	42	17	30		Unknown	Unknown			0	0
31	43	17	31		Unknown	Unknown			0	0
32	44	18	32		Unknown	Unknown			0	0
33	45	18	33		Unknown	Unknown			0	0
34	46	18	34		Unknown	Unknown			0	0
35	47	18	35		Unknown	Unknown			0	0
36	48	19	36		Unknown	Unknown			0	0
37	49	19	37		Unknown	Unknown			0	0
38	50	19	38		Unknown	Unknown			0	0
39	51	19	39		Unknown	Unknown			0	0
40	52	19	40		Unknown	Unknown			0	0
41	53	19	41		Unknown	Unknown			0	0

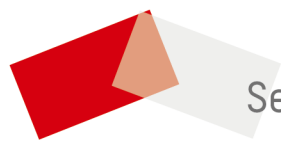
Figure 10-1 Parking Space Information Statistics

10.2 Viewing LED Guidance Screen Information

You can view all the LED guidance screen information in **LED Guidance Screen Information** tab.

No.	LED ID	Serial No.	Device Type	Serial Port	LED IP	Screen Width	Screen Height	Font Color	Font Size	Display Mode
1	30	30	Network Guidance Screen	0	192.168.254.226	128	32	Red	Small	Instant Display
2	40	40	Network Guidance Screen	0	192.168.254.220	128	32	Red	Small	Instant Display

Figure 10-2 LED Guidance Screen Information Statistics



See Far, Go Further