



Video Intercom Door Station (D Series)

User Manual

User Manual

©2018 Hangzhou Hikvision Digital Technology Co., Ltd.

This user manual is intended for users of the models below:

Series	Model
Door Station (D Series)	DS-KD8102-V
	DS-KD8002-VM
	DS-KD3002-VM

It includes instructions on how to use the Product. The software embodied in the Product is governed by the user license agreement covering that Product.

About this Manual

This Manual is subject to domestic and international copyright protection. Hangzhou Hikvision Digital Technology Co., Ltd. (“Hikvision”) reserves all rights to this manual. This manual cannot be reproduced, changed, translated, or distributed, partially or wholly, by any means, without the prior written permission of Hikvision.

Trademarks

HIKVISION and other Hikvision marks are the property of Hikvision and are registered trademarks or the subject of applications for the same by Hikvision and/or its affiliates. Other trademarks mentioned in this manual are the properties of their respective owners. No right of license is given to use such trademarks without express permission.

Disclaimer

TO THE MAXIMUM EXTENT PERMITTED BY APPLICABLE LAW, HIKVISION MAKES NO WARRANTIES, EXPRESS OR IMPLIED, INCLUDING WITHOUT LIMITATION THE IMPLIED WARRANTIES OF MERCHANTABILITY AND FITNESS FOR A PARTICULAR PURPOSE, REGARDING THIS MANUAL. HIKVISION DOES NOT WARRANT, GUARANTEE, OR MAKE ANY REPRESENTATIONS REGARDING THE USE OF THE MANUAL, OR THE CORRECTNESS, ACCURACY, OR RELIABILITY OF INFORMATION CONTAINED HEREIN. YOUR USE OF THIS MANUAL AND ANY RELIANCE ON THIS MANUAL SHALL BE WHOLLY AT YOUR OWN RISK AND RESPONSIBILITY.

TO THE MAXIMUM EXTENT PERMITTED BY APPLICABLE LAW, IN NO EVENT WILL HIKVISION, ITS DIRECTORS, OFFICERS, EMPLOYEES, OR AGENTS BE LIABLE TO YOU FOR ANY SPECIAL, CONSEQUENTIAL, INCIDENTAL, OR INDIRECT DAMAGES, INCLUDING, AMONG OTHERS, DAMAGES FOR LOSS OF BUSINESS PROFITS, BUSINESS INTERRUPTION, SECURITY BREACHES, OR LOSS OF DATA OR DOCUMENTATION, IN CONNECTION WITH THE USE OF OR RELIANCE ON THIS MANUAL, EVEN IF HIKVISION HAS BEEN ADVISED OF THE POSSIBILITY OF SUCH DAMAGES.

SOME JURISDICTIONS DO NOT ALLOW THE EXCLUSION OR LIMITATION OF LIABILITY OR CERTAIN DAMAGES, SO SOME OR ALL OF THE ABOVE EXCLUSIONS OR LIMITATIONS MAY NOT APPLY TO YOU.

Support

Should you have any questions, please do not hesitate to contact your local dealer.

Regulatory Information

FCC Information

Please take attention that changes or modification not expressly approved by the party responsible for compliance could void the user's authority to operate the equipment.

FCC compliance: This equipment has been tested and found to comply with the limits for a Class B digital device, pursuant to part 15 of the FCC Rules. These limits are designed to provide reasonable protection against harmful interference in a residential installation. This equipment generates, uses and can radiate radio frequency energy and, if not installed and used in accordance with the instructions, may cause harmful interference to radio communications. However, there is no guarantee that interference will not occur in a particular installation. If this equipment does cause harmful interference to radio or television reception, which can be determined by turning the equipment off and on, the user is encouraged to try to correct the interference by one or more of the following measures:

- Reorient or relocate the receiving antenna.
- Increase the separation between the equipment and receiver.
- Connect the equipment into an outlet on a circuit different from that to which the receiver is connected.
- Consult the dealer or an experienced radio/TV technician for help.

FCC Conditions

This device complies with part 15 of the FCC Rules. Operation is subject to the following two conditions:

1. This device may not cause harmful interference.
2. This device must accept any interference received, including interference that may cause undesired operation.

EU Conformity Statement



This product and - if applicable - the supplied accessories too are marked with "CE" and comply therefore with the applicable harmonized European standards listed under the EMC Directive 2014/30/EU, the RoHS Directive 2011/65/EU.



2012/19/EU (WEEE directive): Products marked with this symbol cannot be disposed of as unsorted municipal waste in the European Union. For proper recycling, return this product to your local supplier upon the purchase of equivalent new equipment, or dispose of it at designated collection points. For more information see:

www.recyclethis.info



2006/66/EC (battery directive): This product contains a battery that cannot be disposed of as unsorted municipal waste in the European Union. See the product documentation for specific battery information. The battery is marked with this symbol, which may include lettering to indicate cadmium (Cd), lead (Pb), or mercury (Hg). For proper recycling, return the battery to your supplier or to a designated collection point. For more information see: www.recyclethis.info

Industry Canada ICES-003 Compliance

This device meets the CAN ICES-3 (B)/NMB-3(B) standards requirements.



Safety Instruction

These instructions are intended to ensure that user can use the product correctly to avoid danger or property loss.

The precaution measure is divided into **Warnings** and **Cautions**:

Warnings: Neglecting any of the warnings may cause serious injury or death.

Cautions: Neglecting any of the cautions may cause injury or equipment damage.

	
Warnings Follow these safeguards to prevent serious injury or death.	Cautions Follow these precautions to prevent potential injury or material damage.



Warnings

- The working temperature of the device is from -40° C to 60° C.
- All the electronic operation should be strictly compliance with the electrical safety regulations, fire prevention regulations and other related regulations in your local region.
- Please use the power adapter, which is provided by normal company. The power consumption cannot be less than the required value.
- Do not connect several devices to one power adapter as adapter overload may cause over-heat or fire hazard.
- Please make sure that the power has been disconnected before you wire, install or dismantle the device.
- When the product is installed on wall or ceiling, the device shall be firmly fixed.
- If smoke, odors or noise rise from the device, turn off the power at once and unplug the power cable, and then please contact the service center.
- If the product does not work properly, please contact your dealer or the nearest service center. Never attempt to disassemble the device yourself. (We shall not assume any responsibility for problems caused by unauthorized repair or maintenance.)
- The power supply must conform to LPS. The recommended adaptor models and manufacturers are shown as below. Use the attached adaptor, and do not change the adaptor randomly.

Model	Manufacturer	Standard
DSA-12PFG-12 FCH 120100	Dee Van Electronics Co., Ltd.	GB
DSA-12PFG-12 FEU 120100	Dee Van Electronics Co., Ltd.	EN
DSA-12PFT-12FUS120100	Dee Van Electronics Co., Ltd.	ANSI

Model	Manufacturer	Standard
DSA-12PFG-12 FUK 120100	Dee Van Electronics Co., Ltd.	BSW
DSA-12PFG-12 FAU 120100	Dee Van Electronics Co., Ltd.	AS



Cautions

- Do not drop the device or subject it to physical shock, and do not expose it to high electromagnetism radiation. Avoid the equipment installation on vibrations surface or places subject to shock (ignorance can cause equipment damage).
- Do not place the device in extremely hot (refer to the specification of the device for the detailed operating temperature), cold, dusty or damp locations, and do not expose it to high electromagnetic radiation.
- The device cover for indoor use shall be kept from rain and moisture.
- Exposing the equipment to direct sun light, low ventilation or heat source such as heater or radiator is forbidden (ignorance can cause fire danger).
- Do not aim the device at the sun or extra bright places. A blooming or smear may occur otherwise (which is not a malfunction however), and affecting the endurance of sensor at the same time.
- Please use the provided glove when open up the device cover, avoid direct contact with the device cover, because the acidic sweat of the fingers may erode the surface coating of the device cover.
- Please use a soft and dry cloth when clean inside and outside surfaces of the device cover, do not use alkaline detergents.
- Please keep all wrappers after unpack them for future use. In case of any failure occurred, you need to return the device to the factory with the original wrapper. Transportation without the original wrapper may result in damage on the device and lead to additional costs.
- Improper use or replacement of the battery may result in hazard of explosion. Replace with the same or equivalent type only. Dispose of used batteries according to the instructions provided by the battery manufacturer.

Table of Contents

1 Overview	1
1.1 Introduction	1
1.2 Main Features	1
2 Appearance	2
2.1 Appearance of DS-KD8102-V	2
2.2 Appearance of DS-KD8002-VM.....	3
2.3 Appearance of DS-KD3002-VM.....	4
3 Typical Application	5
4 Terminal and Wiring	6
4.1 Terminal Description.....	6
4.1.1 Terminals and Interfaces of DS-KD8102-V/ DS-KD8002-VM	6
4.1.2 Terminals and Interfaces of DS-KD3002-VM.....	8
4.2 Wiring Description.....	10
4.2.1 Door Lock Wiring.....	10
4.2.2 Door Magnetic Wiring	10
4.2.3 Exit Button Wiring	12
4.2.4 External Card Reader Wiring	13
4.2.5 External Elevator Controller Wiring.....	15
4.2.6 Alarm Device Input Wiring.....	15
4.2.7 Alarm Device Output Wiring.....	16
5 Installation	18
5.1 Installation of DS-KD8102-V	18
5.1.1 Gang Box for DS-KD8102-V	18
5.1.2 Wall Mounting with Gang Box of DS-KD8102-V.....	19
5.2 Installation of DS-KD8002-VM	21
5.2.1 Gang Box for DS-KD8002-VM	21
5.2.2 Wall Mounting with Gang Box of DS-KD8002-VM	21
5.3 Installation of DS-KD3002-VM	24
5.3.1 Gang Box for DS-KD3002-VM	24
5.3.2 Wall Mounting with Gang Box of DS-KD3002-VM	24
6 Local Operation	27
6.1 Keys Description	27
6.2 Activate Device.....	27
6.3 Status.....	29
6.4 Set Parameters	29
6.4.1 Set Door Station No.....	30
6.4.2 Edit Network Parameters.....	31
6.4.3 Change Password	32
6.4.4 Issue Card	34

6.4.5 Set Volume.....	36
6.4.6 About.....	37
6.4.7 Change System Language.....	37
6.4.8 Open Source Software Licenses.....	38
6.5 Call Resident.....	38
6.6 Unlock Door.....	39
7 Remote Operation via Batch Configuration Tool.....	40
7.1 Activate Device Remotely.....	40
7.2 Edit Network Parameters.....	41
7.3 Add Device.....	42
7.3.1 Add Online Device.....	42
7.3.2 Add by IP Address.....	43
7.3.3 Add by IP Segment.....	44
7.4 Configure Devices Remotely.....	45
7.4.1 System.....	45
7.4.2 Video Intercom.....	51
7.4.3 Network.....	56
7.4.4 Video Display.....	60
7.5 Video Intercom Device Set-up Tool.....	61
7.5.1 Set a Community Structure.....	61
7.5.2 Set Main/Sub Door Station.....	62
7.6 Batch Upgrading.....	64
7.6.1 Add Devices for Upgrading.....	64
7.6.2 Upgrade Devices.....	67
8 Remote Operation via iVMS-4200.....	68
8.1 System Configuration.....	68
8.2 Device Management.....	69
8.2.1 Add Video Intercom Devices.....	69
8.2.2 Modify Network Information.....	71
8.2.3 Reset Password.....	72
8.3 Remote Configuration.....	74
8.4 Person and Card Management.....	74
8.4.1 Organization Management.....	76
8.4.2 Person Management.....	77
8.5 Video Intercom.....	83
8.5.1 Receive Call from Indoor Station/Door Station.....	84
8.5.2 View Live Video of Door Station and Outer Door Station.....	85
8.5.3 View Call Logs.....	86
8.5.4 Release Notice.....	87
8.5.5 Search Video Intercom Information.....	90
Appendix.....	94
Installation Notice.....	94
Wiring Cables.....	94

1 Overview

1.1 Introduction

The video intercom system can realize functions such as video intercom, resident-to-resident video call, live view of HD video, access control, one-card system, elevator linkage, 8-ch zone alarm, notice information and visitor messages to provide a complete smart community video intercom solution.

The video intercom door station is mainly applied to situations such as community, villa, and official buildings.

1.2 Main Features

- Video intercom function
- HD video (Max. resolution 1280×720@30fps, WDR, 120° wide angle)
- Self-adaptive light supplement
- Access control function
- Activating card via local station function (This function will be invalid if the card has been activated via iVMS-4200)
- Auto-uploading captured pictures to FTP or iVMS-4200 Client while unlocking the door
- Elevator linkage
- Door magnetic alarm and tamper-proof alarm function
- Noise suppression and echo cancellation
- IR detection (only supported by DS-KD8102-V model)
- Remote upgrade, batch setting, upgrade via USB flash disk functions

2 Appearance

2.1 Appearance of DS-KD8102-V

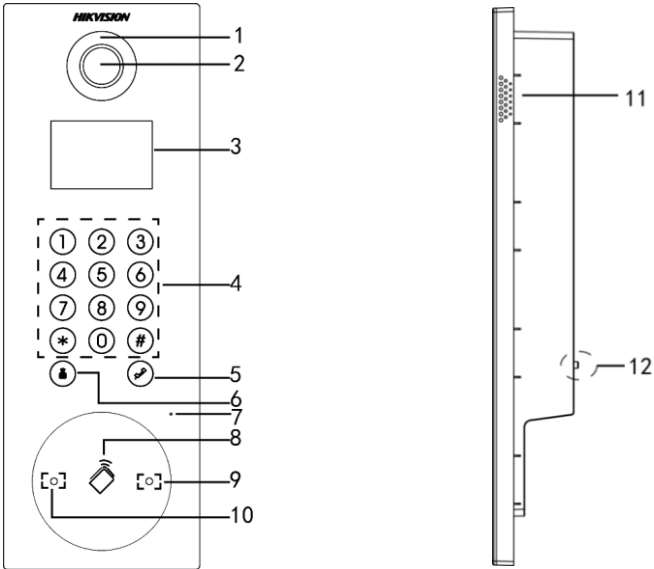

Table 2-1 Descriptions of Keys

No.	Description
1	Low Illumination Supplement Light
2	Built-in Camera
3	LCD Display Screen
4	Keypad
5	Call Button
6	Call Center Key
7	Microphone
8	Card Induction Area
9	IR Emission
10	IR Receiver

11	Loudspeaker
12	TAMPER

2.2 Appearance of DS-KD8002-VM

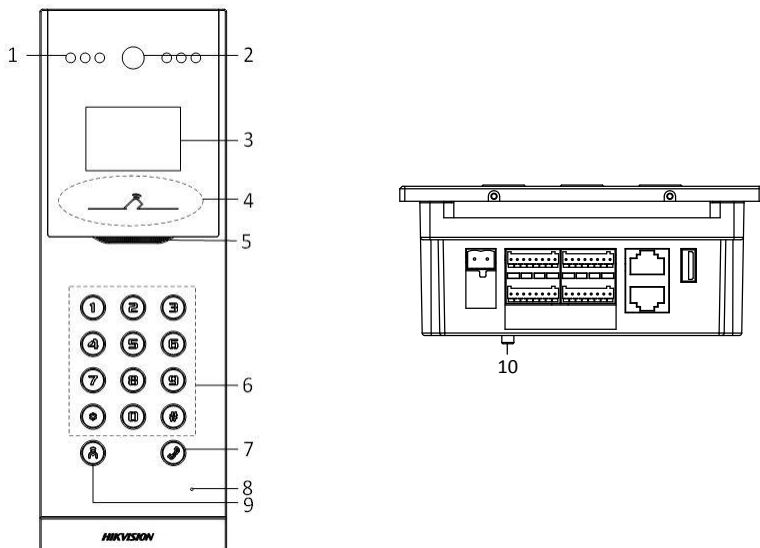

Table 2-2 Descriptions of Keys

No.	Description
1	Low Illumination Supplement Light
2	Built-in Camera
3	LCD Display Screen
4	Card Induction Area
5	Loudspeaker
6	Keypad
7	Call Button
8	Microphone
9	Call Center Key
10	TAMPER

2.3 Appearance of DS-KD3002-VM

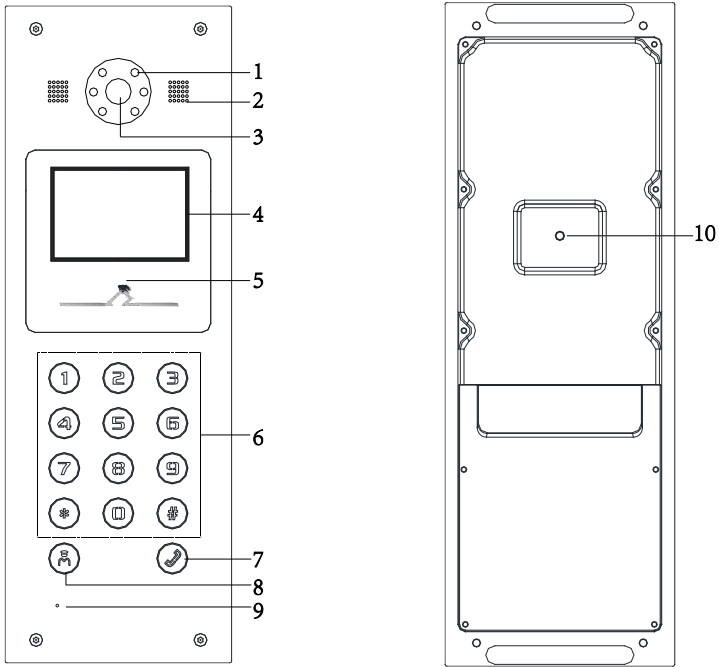
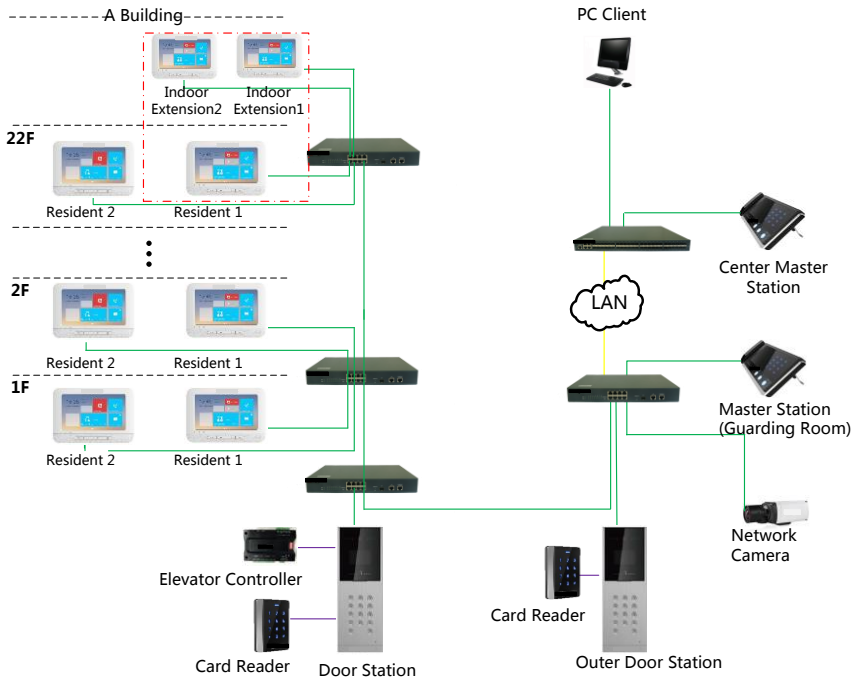

Table 2-3 Descriptions of Keys

No.	Description
1	Low Illumination Supplement Light
2	Built-in Camera
3	Loudspeaker
4	LCD Display Screen
5	Card Induction Area
6	Keypad
7	Call Button
8	Call Center Key
9	Microphone
10	TAMPER

3 Typical Application



4 Terminal and Wiring

4.1 Terminal Description

4.1.1 Terminals and Interfaces of DS-KD8102-V/ DS-KD8002-VM

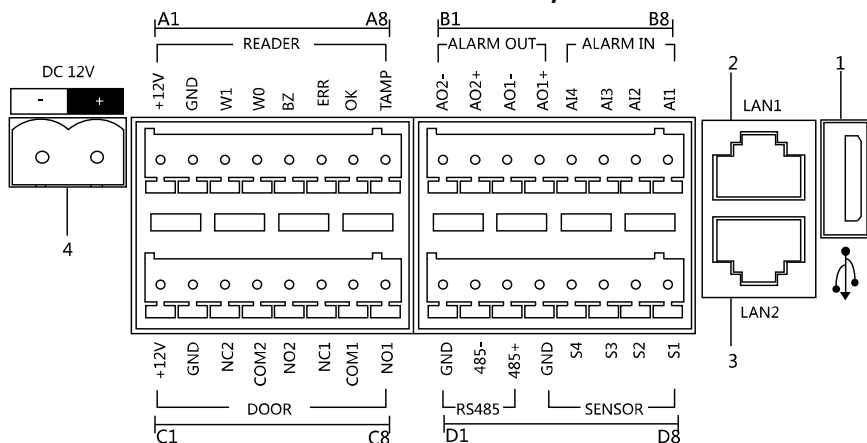

Table 4-1 Descriptions of Terminals and Interfaces

Name	No.	Interface	Description
USB	1	USB	USB Interface
LAN	2	LAN1	Network Interface
	3	LAN2	Analog Interface
Power Supply	4	DC 12V	DC 12V Power Supply Input
READER	A1	12V	Power Supply Output
	A2	GND	Grounding
	A3	W1	Data Input Interface Wiegand Card Reader: Data1
	A4	W0	Data Input Interface Wiegand Card Reader: Data0
	A5	BZ	Card Reader Buzzer Output
	A6	ERR	Card Reader Indicator Output (Invalid Card)

Name	No.	Interface	Description
			Output)
	A7	OK	Card Reader Indicator Output (Valid Card Output)
	A8	TAMP	Tamper-proof Input of Wiegand Card Reader
ALARM OUT	B1	AO2-	Alarm Relay Output 2
	B2	AO2+	
	B3	AO1-	Alarm Relay Output 1
	B4	AO1+	
ALARM IN	B5	AI4	Alarm Input 4
	B6	AI3	Alarm Input 3
	B7	AI2	Alarm Input 2
	B8	AI1	Alarm Input 1
DOOR	C1	12V	Power Supply Output
	C2	GND	Grounding
	C3	NC2	Door Lock Relay Output (NC)
	C4	COM2	Grounding Signal
	C5	NO2	Door Lock Relay Output (NO)
	C6	NC1	Door Lock Relay Output (NC)
	C7	COM1	Grounding Signal
	C8	NO1	Door Lock Relay Output (NO)
RS485	D1	GND	RS-485 Communication Interfaces
	D2	485-	
	D3	485+	
SENSOR	D4	GND	Grounding Signal
	D5	S4	Door Magnetic Detection Input 4/Exit Button
	D6	S3	Door Magnetic Detection Input 3/Exit Button
	D7	S2	Door Magnetic Detection Input 2/Exit Button
	D8	S1	Door Magnetic Detection Input 1/Exit Button

4.1.2 Terminals and Interfaces of DS-KD3002-VM

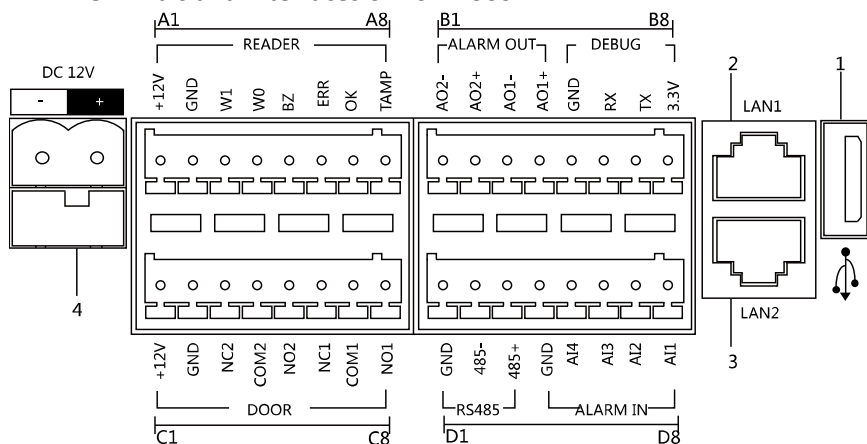

Table 4-2 Descriptions of Terminals and Interfaces

Name	No.	Interface	Description
USB	1	USB	USB Interface
LAN	2	LAN1	Network Interface
	3	LAN2	Analog Interface
Power Supply	4	DC 12V	DC 12V Power Supply Input
READER	A1	12V	Power Supply Output
	A2	GND	Grounding
	A3	W1	Data Input Interface Wiegand Card Reader: Data1
	A4	W0	Data Input Interface Wiegand Card Reader: Data0
	A5	BZ	Card Reader Buzzer Output
	A6	ERR	Card Reader Indicator Output (Invalid Card Output)
	A7	OK	Card Reader Indicator Output (Valid Card Output)
	A8	TAMP	Tamper-proof Input of Wiegand Card Reader
ALARM OUT	B1	AO2-	Alarm Relay Output 2
	B2	AO2+	

Name	No.	Interface	Description
	B3	AO1-	Alarm Relay Output 1
	B4	AO1+	
DEBUG	B5	GND	Grounding
	B6	RX	Serial Port Debugging/Receive data
	B7	TX	Serial Port Debugging/Send data
	B8	3.3V	Serial Port Debugging/Power Supply
DOOR	C1	12V	Power Supply Output
	C2	GND	Grounding
	C3	NC2	Door Lock Relay Output (NC)
	C4	COM2	Grounding Signal
	C5	NO2	Door Lock Relay Output (NO)
	C6	NC1	Door Lock Relay Output (NC)
	C7	COM1	Grounding Signal
	C8	NO1	Door Lock Relay Output (NO)
RS485	D1	GND	RS-485 Communication Interfaces
	D2	485-	
	D3	485+	
ALARM IN	D4	GND	Grounding Signal
	D5	AI4	Alarm Input 4
	D6	AI3	Alarm Input 3
	D7	AI2	Alarm Input 2
	D8	AI1	Alarm Input 1

4.2 Wiring Description

4.2.1 Door Lock Wiring

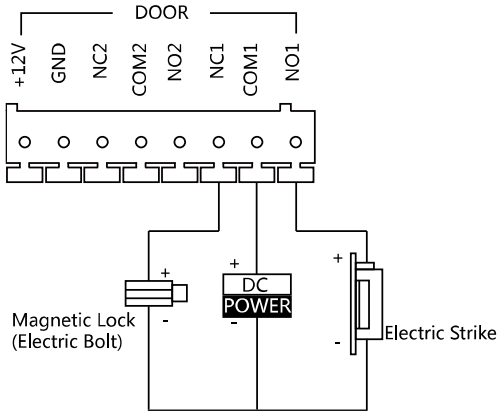

NOTE

- Terminal NC1/COM1 is set as default for accessing magnetic lock/electric bolt; terminal NO1/COM1 is set as default for accessing electric strike.
- To connect electric lock in terminal NO2/COM2/NC2, it is required to set the output of terminal NO2/COM2/NC2 to be electric lock with Batch Configuration Tool or iVMS-4200.

4.2.2 Door Magnetic Wiring

Door Magnetic Wiring for DS-KD8102-V/DS-KD8002-VM

For DS-KD8102-V/DS-KD8002-VM, there are two optional ways of door magnetic wiring.

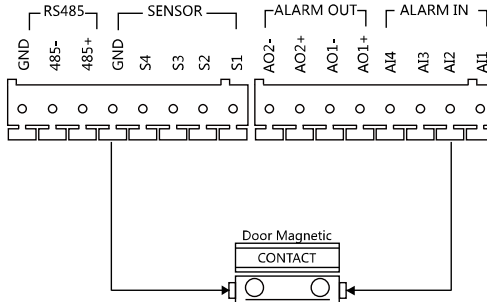

Door Magnetic Wiring for DS-KD8102-V/DS-KD8002-VM (1)

NOTE

To connect the door magnetic, it is required to set the output of terminal A12 to be door magnetic with Batch Configuration Tool or iVMS-4200.

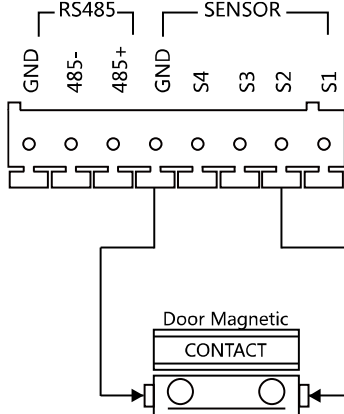

Door Magnetic Wiring for DS-KD8102-V/DS-KD8002-VM (2)

NOTE

Terminal S2 is set as default for connecting door magnetic.

Door Magnetic Wiring for DS-KD3002-VM

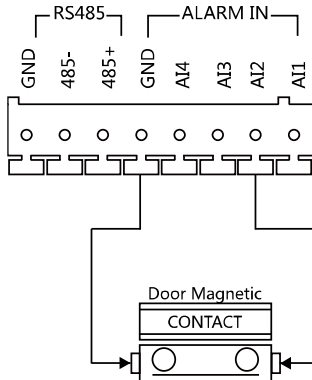

NOTE

To connect the door magnetic, it is required to set the output of terminal AI2 to be door magnetic with Batch Configuration Tool or iVMS-4200.

4.2.3 Exit Button Wiring

Exit Button Wiring for DS-KD8102-V/DS-KD8002-VM

For DS-KD8102-V/DS-KD8002-VM, there are two optional ways of exit button wiring.

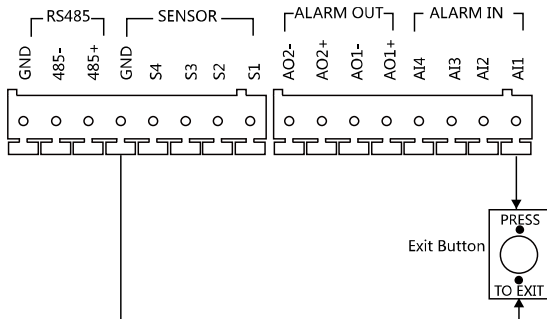

Exit Button Wiring for DS-KD8102-V/DS-KD8002-VM (1)

 **NOTE**

To connect the exit button, it is required to set the output of terminal AI1 to be exit button with Batch Configuration Tool or iVMS-4200.

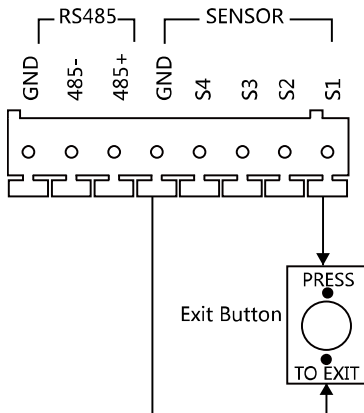

Exit Button Wiring for DS-KD8102-V/DS-KD8002-VM (2)

Exit Button Wiring for DS-KD3002-VM

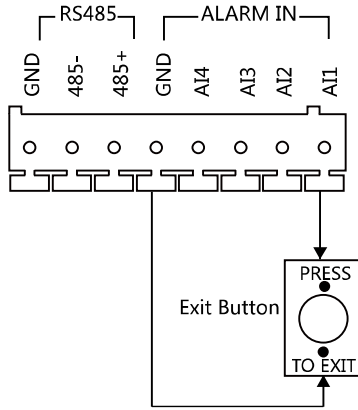

NOTE

Terminal S1 is set as default for connecting exit button.

4.2.4 External Card Reader Wiring

NOTE

- Please set the DIP switch first before connecting the card reader.
- If the DIP switch should be configured when the card reader is power-on, please reboot the card reader after configuring the DIP switch.
- The DIP switch description is shown in the following table:

No.	Description	How to Configure
1-4	Set the RS-485 address	ON: 1 OFF: 0
6	Select Wiegand protocol or RS-485 protocol	ON: Wiegand OFF: RS-485
7	Set the Wiegand protocol (It is invalid when setting OFF in 6.)	ON: Wiegand 26 OFF: Wiegand 34

RS-485 Card Reader Wiring

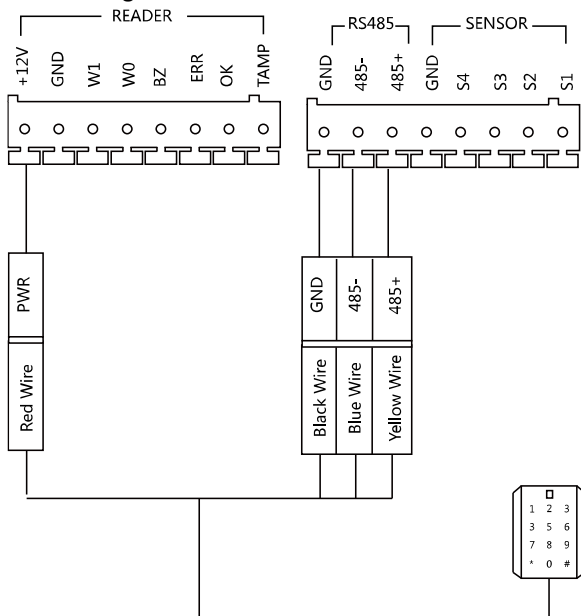

Wiegand Card Reader Wiring

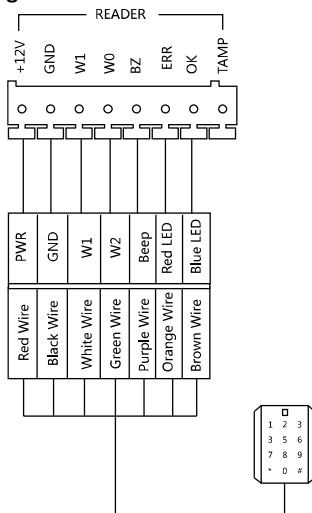

4.2.5 External Elevator Controller Wiring

You can connect the door station to the elevator controller via RS-485 interface. There are 4 groups of RS-485 interfaces on the elevator controller: group A, group B, Group C, and Group D. Group C is used to connect to the door station.

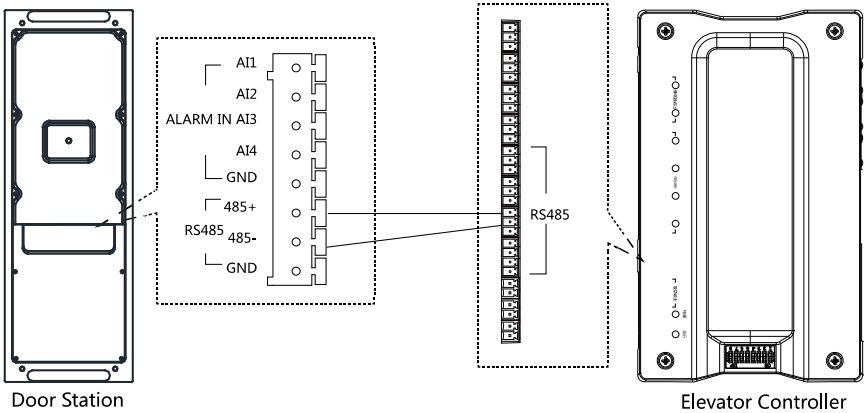

4.2.6 Alarm Device Input Wiring

Alarm Device Input Wiring for DS-KD8102-V

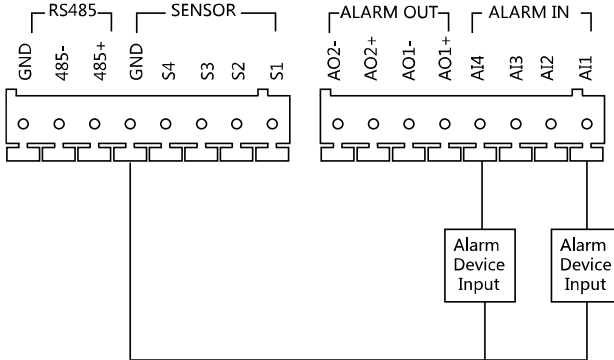

Alarm Device Input Wiring for DS-KD3002-VM

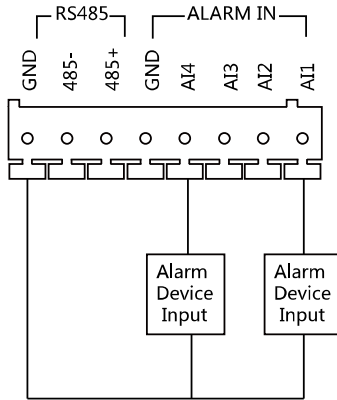

4.2.7 Alarm Device Output Wiring

Alarm Device Output Wiring for DS-KD8102-V/DS-KD8002-VM

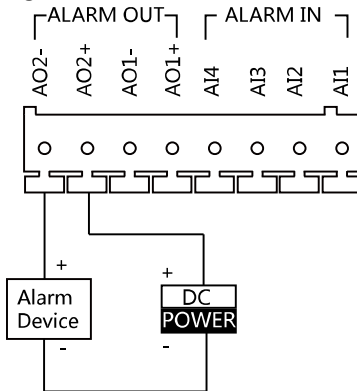

Alarm Device Output Wiring for DS-KD3002-VM

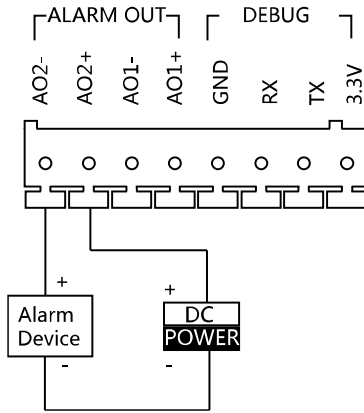

5 Installation

Before you start:

- Make sure the device in the package is in good condition and all the assembly parts are included.
- The power supply the door station supports is 12 VDC. Please make sure your power supply matches your door station.
- Make sure all the related equipment is power-off during the installation.
- Check the product specification for the installation environment.

5.1 Installation of DS-KD8102-V

To install the door station onto the wall, you are required to use a matched gang box.

5.1.1 Gang Box for DS-KD8102-V

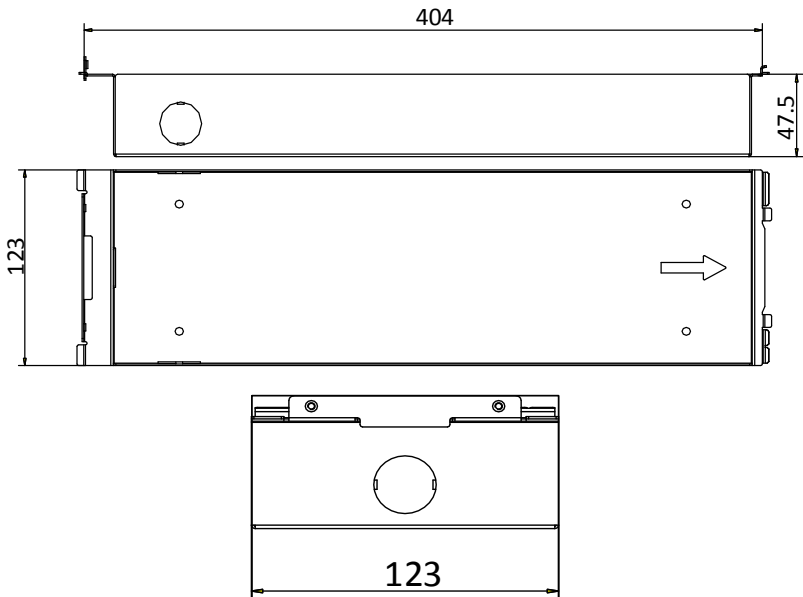

 **NOTE**

- The dimension of gang box for model DS-KD8102-V door station is: 404 (length)×123 (width)×47.5 (depth) mm.
- The dimensions above are for reference only. The actual size can be slightly different from the theoretical dimension.

5.1.2 Wall Mounting with Gang Box of DS-KD8102-V

Steps:

1. Chisel a hole in the wall for inserting the gang box. The size of the hole should be larger than that of the gang box. The suggested size of hole is 404.5 (length) × 123.5 (width) × 48 (depth) mm.
2. Insert the gang box into the hole and fix it with 4 PA4 screws. Make sure the edges of the gang box align to the wall.

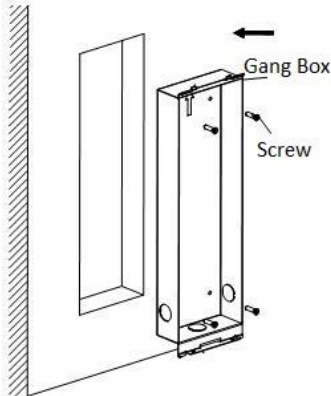

3. Route the cables of the door station through the cable hole.
4. Put the door station into the gang box and hook the lock catches on the rear panel onto the hook **A and B** of the gang box.

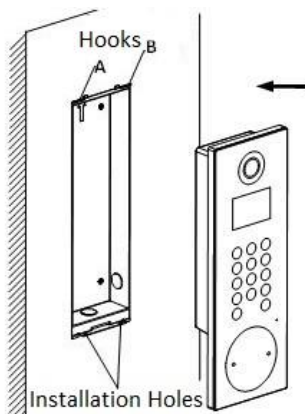

5. Pull the door station downward and then push it towards the inside to make sure it fits the hole.
6. Tighten the screws of the door station with the Allen wrench.

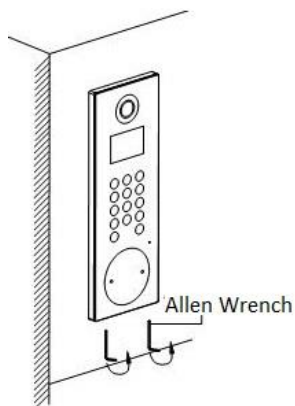

5.2 Installation of DS-KD8002-VM

5.2.1 Gang Box for DS-KD8002-VM

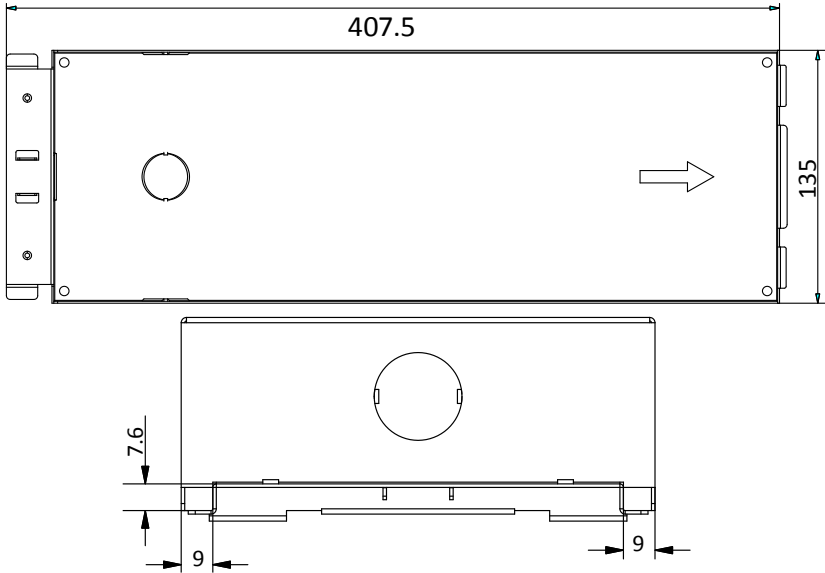

NOTE

- The dimension of gang box for model DS-KD8002-VM door station is: 407.5 mm × 135 mm × 55 mm.
- The dimensions above are for reference only. The actual size can be slightly larger than the theoretical dimension.

5.2.2 Wall Mounting with Gang Box of DS-KD8002-VM

1. Chisel a hole in the wall for inserting the gang box. The size of the hole should be larger than that of the gang box. The suggested size of hole is 136 (length) × 408.5 (width) × 55.5 (depth) mm.

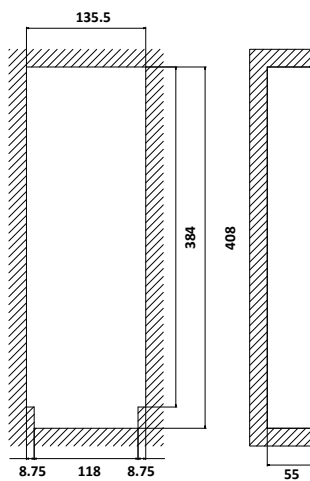

2. Insert the gang box into the hole and fix it with 4 PA4 screws.

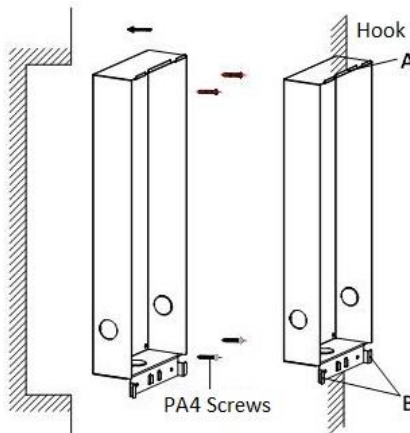

3. Make sure the edges of the gang box align to the wall and the hook **A** and hook **B** of the gang box hook onto the wall.
4. Route the cables of the door station through the cable hole.
5. Insert the door station into the gang box and then move the door station downward to hook the lock catches on the rear panel onto the hook **C** of the gang box.
6. Fix the door station with 2 PM3 screws.

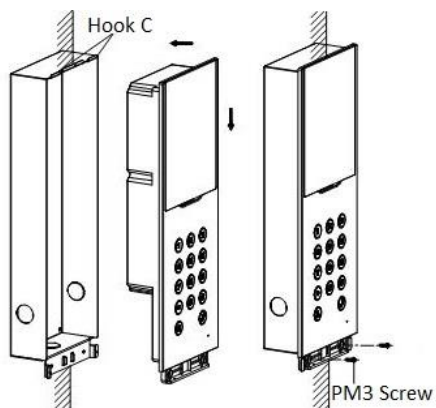

7. After fixing the door station onto the gang box, secure it by inserting the plate and insert 2 POM2 screws.

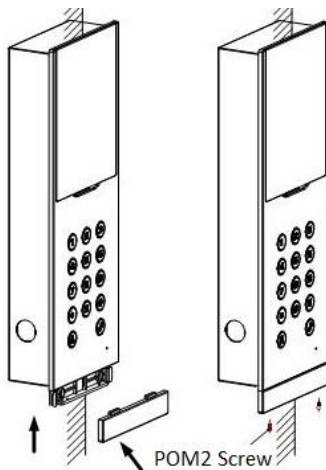

5.3 Installation of DS-KD3002-VM

5.3.1 Gang Box for DS-KD3002-VM

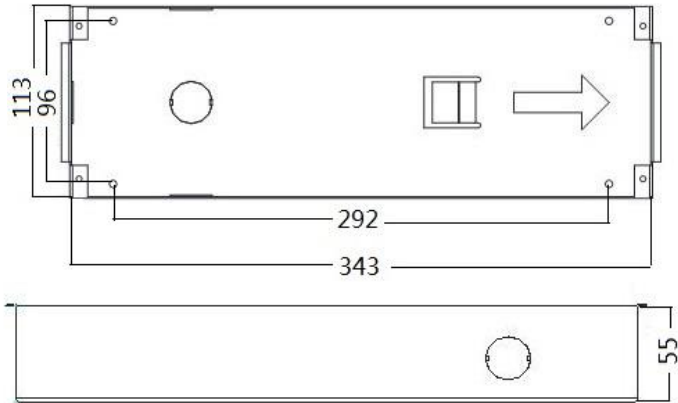

NOTE

- The dimension of gang box for model DS-KD3002-VM door station is: 343(length) × 113(width) × 55(depth) mm.
- The dimensions above are for reference only. The actual size can be slightly different from the theoretical dimension.

5.3.2 Wall Mounting with Gang Box of DS-KD3002-VM

Steps:

1. Chisel a hole in the wall for inserting the gang box. The size of the hole should be larger than that of the gang box. The suggested size of hole is 343.5 (length) × 113.5 (width) × 55.5 (depth) mm.
2. Insert the gang box into the hole and fix it with 4 PA4 screws.

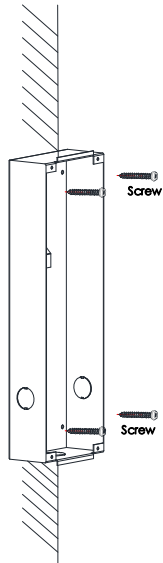

3. Make sure the edges of the gang box align to the wall.
4. Route the cables of the door station through the cable hole.
5. Put the door station into the gang box.

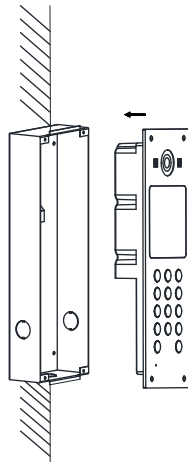

6. Fix the door station to the gang box with 4 screws.

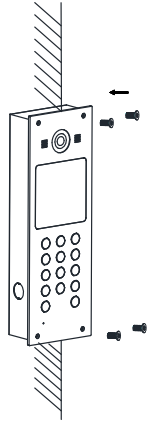

6 Local Operation

6.1 Keys Description

Key descriptions of door stations are illustrated in Table 6-1.

Table 6-1 Key Descriptions

Key	Description
Numeric Key 2	▲
Numeric Key 4	▼
Numeric Key 6	◀
Numeric Key 8	▶
#	Call Key (When calling residents or center)
	Confirm
*	Return
	Delete

6.2 Activate Device

You cannot use the door station until you activate it.

Steps:

1. Power on the door station to enter the activation interface automatically.

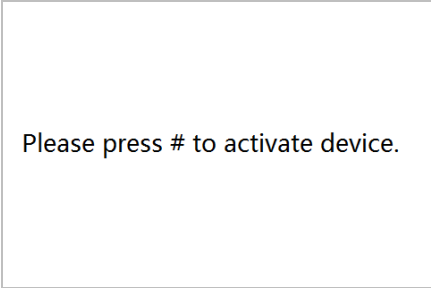

Please press # to activate device.

2. Press the # key.

New Password:

Confirm Password:

1, .?!*#-	2abc	3def
4ghi	5jkl	6mno
7pqrs	8tuv	9wxyz

3. Enter a new password, and confirm the password.

The character description for each numeric key is shown in Table 6-2.

Table 6-2 Character Description

Key	Description	Key	Description
1	1, .?!*#-	6	6mnoMNO
2	2abcABC	7	7pqrsPQRS
3	3defDEF	8	8tuvTUV
4	4ghiGHI	9	9wxyzWXYZ
5	5klJKLM	0	0

 **NOTE**

When entering the password, taking the numeric key **2** as example, press the numeric key **2** once, the text field shows "2", and press it again, the text field shows "a", and press it again, the text field shows "b", and so on.

STRONG PASSWORD RECOMMENDED— *We highly recommend you create a strong password of your own choosing (Using a minimum of 8 characters, including at least three of the following categories: upper case letters, lower case letters, numbers, and special characters.) in order to increase the security of your product. And we recommend you reset your password regularly, especially in the high security system, resetting the password monthly or weekly can better protect your product.*







4. Press the # key to complete the activation.

6.3 Status

The door station can display different status with icons in Table 6-3.

Table 6-3 Icon Description

Icon	Description
 Network!	Please check the network cable of the door station.
 Center!	Invalid SIP server IP address. Set the SIP server IP address.
	Network of SIP server is not available. Check the SIP server network connection.
	SIP server communication is not available. Check if the SIP server IP address is correct.
 Center	SIP server rejected to login the device. Check if the device No. has been registered.
	The network connection of the main door station/outer door station is normal, and the main door station/outer door station has been successfully registered to the SIP server.
 Center	The network connection of the sub door station is normal, and the sub door station has been successfully registered to the main door station/SIP server.
	IP address of the door station conflicts with other devices' IP address
 IP Conflict!	

6.4 Set Parameters

You can set the network configuration, local settings, password and volume of the door station. You can also view the version of the device and issue cards with it.

To set parameters for the door station, you should go to the configuration mode first.

Steps:

1. Hold down the * key and the # key for 2s to enter the admin password interface.
2. Enter the admin password, and press the # key.

Input admin password and end with #.



NOTE

- The default admin password is 888999.
- Under the configuration mode, press the number key **2** and **8** to switch the parameter interfaces.

6.4.1 Set Door Station No.

For the local settings, you can set the door station No. such as community No., building No., floor No., and so on.

Press the numeric keys **4** and **6** to switch to the local settings interface.

1.Device No. Configuration

Select by digital keys.

Steps:

1. On the local settings interface, press the numeric key **1** to enter the device No. settings interfaces.

Project No. :	<input type="text" value="1"/>
Community No. :	<input type="text" value="1"/>
Building No. :	<input type="text" value="1"/>
Floor No. :	<input type="text" value="1"/>
Serial No. :	<input type="text" value="0"/>

Device No. Settings Interface (Door Station)

Project No. :	<input type="text" value="1"/>
Serial No. :	<input type="text" value="1"/>

Device No. Settings Interface (Outer Door Station)

2. Edit parameters.

- 1) Move the cursor to parameters to be configured.
- 2) Press the # key to enter the editing mode, and input numbers.
- 3) Press the # key to exit the editing mode.

3. Press the * key to exit the device No. settings interface.



NOTE

- In the main/sub door station mode, the serial No. of main door station should be set as 0, and the serial No. of sub door station should be larger than 0.
- For each main door station, at most 8 sub door stations can be installed.
- For the outer door station, the serial No. cannot be set as 0.

6.4.2 Edit Network Parameters

Purpose:

Network connection is mandatory for the use of door station.

Steps:

1. Enter the network parameters settings interface.

- 1) Press the numeric keys **4** and **6** to switch to the network configuration interface

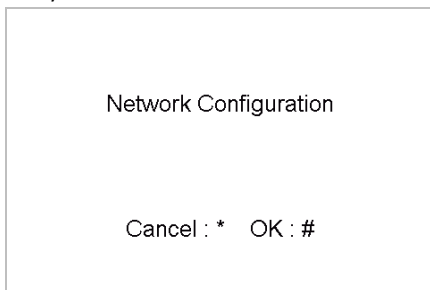

- 2) Press the # key to enter the network parameters settings interface.

With the private SIP protocol, you should set IP address, sub mask, gateway, SIP IP, master IP, and center IP for the door station.

IP Address :	192 . 0 . 0 . 65
Sub Mask:	255 . 255 . 255 . 0
Gateway:	192 . 0 . 0 . 1
SIP IP:	0 . 0 . 0 . 0
Master IP:	0 . 0 . 0 . 0
Center IP:	0 . 0 . 0 . 0

Network Parameters Settings Interface (private SIP)

With the standard SIP protocol, you should set IP address, sub mask, gateway, and center IP.

IP Address:	10 . 7 . 113 . 169
Sub Mask:	255 . 255 . 255 . 0
Gateway:	10 . 7 . 113 . 254
Center IP:	0 . 0 . 0 . 0

Network Parameters Settings Interface (standard SIP)

2. Edit network parameters.
 - 1) Move the cursor to parameters to be configured.
 - 2) Press the # key to enter or exit the editing mode.
3. Press the * key to exit the network configuration interface.

6.4.3 Change Password

Purpose:

2 kinds of password are available when using the door station: configuration password (admin password) and card activation password.

Configuration Password: It is necessary when you want to configure parameters of the door station, such as IP parameters, door station No., system type, and so on.

Card Activation Password: It is necessary when you want to issue cards via password.



The default configuration password is 888999. We recommend you reset your password regularly, especially in the high security system, resetting the password monthly or weekly can better protect your product.

Press the numeric keys **4** and **6** to switch to the password settings interface.

1.Configuration Password

2.Card Activation Password

Press 1 or 2 to select the mode.

Change Configuration Password

Steps:

1. On the password settings interface, press the numeric key **1** to enter the configuration password changing interface.

Old Password :

New Password :

Confirm Password:

2. Enter the old password, and the new password, and confirm the new one.
 - 1) Move the cursor to parameters to be configured.
 - 2) Press the # key to enter or exit the editing mode.
3. Press the * key to exit the password settings interface.

Change Card Activation Password

Steps:

1. On the password settings interface, press the numeric key **2** to enter the card activation password changing interface.

Old Password :	<input type="text"/>	<input type="text"/>
New Password :	<input type="text"/>	
Confirm Password:	<input type="text"/>	

2. Enter the old password, and the new password, and confirm the new one.
 - 3) Move the cursor to parameters to be configured.
 - 4) Press the # key to enter or exit the editing mode.
3. Press the * key to exit the password settings interface.

6.4.4 Issue Card

Purpose:

You cannot open door by swiping the card until you have issue the card.

You can issue the card both locally or remotely. For the detail information about issuing card remotely, please refer to *8.4.2 Person Management*.

2 methods of issuing card locally are available: issuing card via the main card, and issuing card via the card activation password.

Issuing Card via Main Card: You can swipe card to issue it after swiping the main card in advance.

Issuing Card via Password: You can swipe card to issue it after inputting the card activation password in advance.

Press the numeric key 4 and 6 to enter the card issuing interface.

1.Issue Card via Main Card
2.Issue Card via Password
Press 1 or 2 to select the mode.

Issue Card via Main Card

Steps:

1. On the card issuing interface, press the numeric key **1** to enter the main card swiping interface.

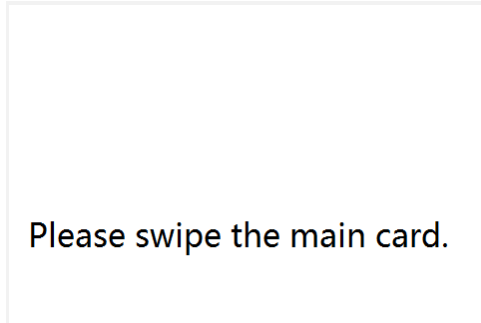

2. Swipe the main card on the card induction area, and hear a voice prompt: Issuing card succeed.
3. Swipe the unauthorized sub cards in turn after hearing a voice prompt: Please swipe the sub card.
4. Press the * key to exit the card issuing interface.



NOTE

- If the main card is invalid, it prompts the message: Incorrect Main Card.
- For the door station (D series), if the amount of sub cards exceeds 2500, no more sub card can be issued and the station prompts the message: No more sub card can be issued.
- For the outer door station, if the amount of sub cards exceeds 50000, no more sub card can be issued and the station prompts the message: No more sub card can be issued.
- After enrolling cards with client software, the card issuing function will be disabled on the user interface.

Issue Card via Password

Steps:

1. On the card issuing interface, press the numeric key **2** to enter the card activation password settings interface or the card activation password inputting interface.

Set the password first.

New Password :

Confirm Password:

Card Activation Password Settings Interface

Enter the password, and end with #.

Card Activation Password Inputting Interface

2. Set the card activation password or input the card activation password to enter the card swiping interface.
3. Swipe the authorized card in turn.
4. Press the * key to exit the card issuing interface.



NOTE

- For the door station (D series), if the amount of sub cards exceeds 2500, no more sub card can be issued and the station prompts the message: No more sub card can be issued.
- For the outer door station, if the amount of sub cards exceeds 50000, no more sub card can be issued and the station prompts the message: No more sub card can be issued.
- After enrolling cards with client software, the card issuing function will be disabled on the user interface.

6.4.5 Set Volume

Steps:

1. Enter the password settings interface.
 - 1) Press the numeric keys **4** and **6** to switch to the volume settings interface

Volume Settings

Cancel : * OK : #

- 2) Press the # key to enter the volume parameters settings interface.



Volume :

Mic :

2. Set the volume.
 - 1) Move the cursor to parameters to be configured.
 - 2) Press the # key to enter or exit the editing mode.
3. Press the * key to exit the volume settings interface.

6.4.6 About

On the settings interface, press numeric keys **4** and **6** to switch to the **About** interface, and press the # key to view the version of the device.

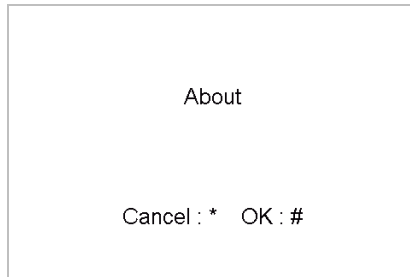

About

Cancel : * OK : #

6.4.7 Change System Language

On the settings interface, press numeric keys **4** and **6** to switch to the **System Language** interface, and press enter the numeric character to switch the system language.

The door station supports 5 kinds of language.

System Language	1
1.English	
2.Français	
3.Русский	
4.Português	
5.Español	

6.4.8 Open Source Software Licenses

On the settings interface, press numeric keys **4** and **6** to switch to the **Open Source Software** interface, and press the **#** key to open source software licenses of the device.

6.5 Call Resident

You can call residents via the door station no matter the door station is in the network intercom system or the analog intercom system.

The door station can work as main/sub door station, and outer door station, which correspond to different calling resident modes respectively.

Work as Main/Sub Door Station

Steps:

1. Enter the calling No.

With the private SIP protocol, the calling No. should be the room No. of the indoor station.

With the standard SIP protocol, the calling No. should be the VoIP phone No. of the indoor station. And you must make sure that the indoor station supports the standard SIP protocol.



2. Press the **#** key or the  key to start calling the resident.

Work as Outer Door Station

Steps:

1. Enter the calling No.

With the private SIP protocol, the calling No. should be the community No. and the **#** key, the Building No. and the **#** key, the Unit No. and the **#** key, and the Room No. and the **#** key.

With the standard SIP protocol, the calling No. should be the VoIP phone No. of the indoor station. And you must make sure that the indoor station supports the standard SIP protocol.

2. Press the  key to start calling the resident.

6.6 Unlock Door

Before you start:

Make sure your door station works as the main/sub door station.

Purpose:

2 ways are available to unlock the door: unlocking door via password, and unlocking door via card.

Unlock Door by Password

Unlocking the door by inputting the password is only available in the network intercom system.

Steps:

1. Enter the # key and the Room No.
2. Enter the password and the # key.



NOTE

- The password varies according to different rooms.
- The default unlocking password is 123456.

Unlock Door by Card

Before you start:

Make sure the card has been issued. You can issue the card via the door station, or via iVMS-4200 client software.

Unlocking the door by swiping the card is available both in the network intercom system and the analog intercom system.

Steps:

Swipe the card on the card induction area to unlock the door.



NOTE

The main card does not support unlocking the door.

7 Remote Operation via Batch Configuration Tool

You can configure and operate the video intercom devices via Batch Configuration Tool. Default parameters of door station are as follows:

- Default IP Address: 192.0.0.65.
- Default Port No.: 8000.
- Default User Name: admin.

7.1 Activate Device Remotely

Purpose

You are required to activate the device first by setting a strong password for it before you can use the device.

Activation via Batch Configuration Tool, and Activation via iVMS-4200 are supported. Here take activation via Batch Configuration Tool as example to introduce the device activation. Please refer to the user manual for the activation via iVMS-4200.

Steps:

1. Run the Batch Configuration Tool.

Index	Device Type	IP Address	Port	Software Version	Serial No.	Security Status	Added
1	XX-XXXX-XX	10.16.2.77	8000	Vx.x.x build xxxxxx	XX-XXXXXX-XXXXXXXXXXXXXXXXXXXXXXXXXXXX	Activated	Yes
2	XX-XXXX-XX	10.16.2.103	8000	Vx.x.x build xxxxxx	XX-XXXXXX-XXXXXXXXXXXXXXXXXXXXXXXXXXXX	Activated	No
3	XX-XXXX-XX	10.16.2.114	8000	Vx.x.x build xxxxxx	XX-XXXXXX-XXXXXXXXXXXXXXXXXXXXXXXXXXXX	Activated	No
4	XX-XXXX-XX	10.16.2.222	8000	Vx.x.x build xxxxxx	XX-XXXXXX-XXXXXXXXXXXXXXXXXXXXXXXXXXXX	Activated	No
5	XX-XXXX-XX	192.0.0.65	8000	Vx.x.x build xxxxxx	XX-XXXXXX-XXXXXXXXXXXXXXXXXXXXXXXXXXXX	Inactive	No

2. Select an inactivated device and click the **Activate** button.

Activate

Password:

Valid password range [8-16].
You can use a combination of numbers, lowercase, uppercase and special character for your password with at least two kinds of them contained.

Confirm password:

3. Create a password, and confirm the password.

STRONG PASSWORD RECOMMENDED– We highly recommend you create a



strong password of your own choosing (Using a minimum of 8 characters, including at least three of the following categories: upper case letters, lower case letters, numbers, and special characters.) in order to increase the security of your product. And we recommend you reset your password regularly, especially in the high security system, resetting the password monthly or weekly can better protect your product.

- Click the **OK** button to activate the device.

 **NOTE**

- When the device is not activated, the basic operation and remote operation of device cannot be performed.
- You can hold the **Ctrl** or **Shift** key to select multiple devices in the online devices, and click the **Activate** button to activate devices in batch.



7.2 Edit Network Parameters

Purpose:

To operate and configure the device via LAN (Local Area Network), you need connect the device in the same subnet with your PC. You can edit network parameters via batch configuration tool, and iVMS-4200 software. Here take editing network parameters via batch configuration tool as example.

Steps:

- Select an online activated device and click the **Edit NET Parameters** button.

Online Devices: 5							
 Edit NET Parameters  Reset Password  Activate							
Index	Device Type	IP Address	Port	Software Version	Serial No.	Security Status	Added
1	XX-XXXX-XX	10.16.2.77	8000	Vx.xx build xxxxxx	XX-XXXX-XXXXXXXXXXXXXXXXXXXXXX	Activated	Yes
2	XX-XXXX-XX	10.16.2.114	8000	Vx.xx build xxxxxx	XX-XXXX-XXXXXXXXXXXXXXXXXXXXXX	Activated	No
3	XX-XXXX-XX	10.16.2.103	8000	Vx.xx build xxxxxx	XX-XXXX-XXXXXXXXXXXXXXXXXXXXXX	Activated	No
4	XX-XXXX-XX	192.0.0.85	8000	Vx.xx build xxxxxx	XX-XXXX-XXXXXXXXXXXXXXXXXXXXXX	Activated	No
5	XX-XXXX-XX	10.16.2.222	8000	Vx.xx build xxxxxx	XX-XXXX-XXXXXXXXXXXXXXXXXXXXXX	Activated	No

- Change the device IP address and gateway address to the same subnet with your computer.
- Enter the password and click the **OK** button to activate the network parameters modification.

Edit NET Parameters	
IP Address:	10.16.6.159
Subnet Mask:	255.255.255.0
Gateway Address:	10.16.6.254
Port No.:	8000
Password:	
<input type="checkbox"/> Enable DHCP	
<input type="button" value="OK"/> <input type="button" value="Cancel"/>	

 **NOTE**

- The default port No. is 8000.
- The default IP address of the door station is 192.0.0.65.
- After editing the network parameters of device, you should add the devices to the device list again.
- Enable DHCP, and the software can obtain network parameters for the device automatically.

7.3 Add Device

Before you start:

Make sure the device to be added has been activated.

Purpose:

For batch configuration tool software, you should add device to the software so as to configure the device remotely.

The software provides 3 ways for adding the devices. You can add the active online devices within your subnet, add devices by IP address, and add devices by IP segment.

7.3.1 Add Online Device

Before you start:

Make sure the device to be added is in the same subnet with your computer. Otherwise, please edit network parameters first.

Steps:

1. Select an active online device or hold the **Ctrl** or **Shift** key to select multiple devices in the online devices list.

Index	Device Type	IP Address	Port	Software Version	Serial No.	Security Status	Added
1	XX-XXXX-XX	10.16.2.77	8000	Vx.x.x build xxxxxx	XX-XXXX-XXXXXXXXXXXXXXXXXXXXXX	Activated	Yes
2	XX-XXXX-XX	10.16.2.114	8000	Vx.x.x build xxxxxx	XX-XXXX-XXXXXXXXXXXXXXXXXXXXXX	Activated	No
3	XX-XXXX-XX	10.16.2.103	8000	Vx.x.x build xxxxxx	XX-XXXX-XXXXXXXXXXXXXXXXXXXXXX	Activated	No
4	XX-XXXX-XX	10.16.2.88	8000	Vx.x.x build xxxxxx	XX-XXXX-XXXXXXXXXXXXXXXXXXXXXX	Activated	No
5	XX-XXXX-XX	10.16.2.222	8000	Vx.x.x build xxxxxx	XX-XXXX-XXXXXXXXXXXXXXXXXXXXXX	Activated	No

2. Click the  button to pop up the login dialog box.

Login

Log into the selected device(s):

User Name:

Password:

OK
Cancel

3. Enter the user name and password.
4. Click the **OK** button to save the settings.

NOTE

- Only devices successfully logged in will be added to the device list for configuration.
- If you add devices in batch, please make sure selected devices have the same user name and password.

7.3.2 Add by IP Address

Purpose:

You can add the device by entering IP address.

Steps:

1. Click the  button to pop up the adding devices dialog box.

 Device(s) in the list will be configured.

Device List 1 Filter: Device List

Index	Device Type	IP Address	Port	Software Version	Serial No.	Security Status	Configuration Status	Configuration
<input type="checkbox"/>	XX-XXXX-XX	10.16.2.8	8000	V x.x.x build xxxxxx	XX-XXXX-XXXXXXXXXXXXXXXXXXXXXX	Strong password		

2. Select IP Address in the adding mode drop-down list.
3. Enter the IP address, and set the port No., user name and password of the device.

4. Click the **OK** button to add the device to the device list.

 **NOTE**

- You cannot add the device(s) to the device list if the user name and password are not identical.
- When you add devices by IP Address, IP Segment or Port No., the devices should be online devices.

7.3.3 Add by IP Segment

Purpose:

You can add many devices at once whose IP addresses are among the IP segment.

Steps:

1. Click the  button to pop up the adding devices dialog box.

Index	Device Type	IP Address	Port	Software Version	Serial No.	Security Status	Configuration Status	Configuration
1	XX-XXXX-XX	10.16.2.8	8000	V.X.X.X build XXXXXX	XX-XXXXXXXXXXXXXXXXXXXX	Strong password		

2. Select IP Segment in the adding mode drop-down list.
3. Set the Start IP Address and End IP Address.
4. Enter port No., user name, and password.

The 'Add' dialog box contains the following fields:

- Adding Mode: IP Segment (dropdown menu)
- Start IP Address: (text input)
- End IP Address: (text input)
- Port No.: 8000 (text input)
- User Name: admin (text input)
- Password: (password field with 6 dots)

Buttons: OK, Cancel

5. Click the **OK** button to search and add the devices whose IP addresses are within the range of the defined IP segment to the device list.

7.4 Configure Devices Remotely

In the device list area, select a device and click **Remote Configuration** or to enter the remote configuration interface.

Index	Device Type	IP Address	Port	Software Version	Serial No.	Security Status	Configuration Status	Configuration
1	XX-XXXX-XX	10.16.2.99	8000	Vx.x.x build xxxxxx	XX-XXXX-XXXXXXXXXXXXXX	Weak password		

7.4.1 System

Click **System** on the remote configuration interface to display the device information: Device Information, General, Time, System Maintenance, User, and RS485, and so on.

Device Information

Click **Device Information** to enter device basic information interface. You can view basic information (the device type, and serial No.), and version information of the device.

Basic Information

Device Type: XX-XXXX-XX

Device Serial No.: XX-XXXX-XXXXXXXXXXXXXXXXXXXX

Version Information

Version: Vx.x.x build xxxxxx

Hardware Version: xxxxxx

General

Click the **General** button to enter device general parameters settings interface. You can view and edit the device name and device ID.

Device Information

Device Name:

Device No.:

Overwrite Record Files: ▼

Time

Steps:

1. Click **Time** to enter the device time settings interface.

Time Zone

Select Time Zone: (GMT+08:00) Beijing, Hong Kong, Perth, Singap... ▼

Enable NTP

Server Address:

NTP Port:

Sync Interval: Minute(s)

Enable DST

Start Time: April ▼ First Week ▼ Sun ▼ 2 :00

End Time: October ▼ Last Week ▼ Sun ▼ 2 :00

DST Bias: 60 min ▼

2. Select Time Zone or Enable NTP.

- **Time Zone**

- 1) Select a time zone from the drop-down list menu.
- 2) Click **Synchronization**.

- **NTP**

- 1) Check the checkbox of Enable NTP to enable NTP.
- 2) Enter the server address, NTP port, and synchronization interval.

- **DST**

- 1) Check the checkbox of Enable DST to enable DST.
- 2) Enter the start time and end time of DST, and set the DST bias.

3. Click **Save** to save and realize the time settings.



NOTE

- The default port No. is 123.

System Maintenance

Purpose:

You can operate the system management and remote upgrading, and change system language on the system maintenance interface.

Steps:

1. Click **System Maintenance** to enter the system maintenance interface.

System Management

Remote Upgrade

Select Type: ▾

Select File: ...

Progress:

Language

▾

2. Click **Reboot** and the system reboot dialog box pops up. Click **Yes** to reboot the system.
3. Click **Restore Default Settings** to restore the default parameters.
4. Click **Restore All** to restore all parameters of device and reset the device to inactive status.



NOTE

- Click **Restore Default Settings** button, all default settings, excluding network parameters, will be restored.

- Click **Restore All** button, all default settings, including network parameters, will be restored. The device will be reset to inactivated status.
5. Click **Import Configuration File** and the import file window pops up. Select the path of remote configuration files. Click **Open** to import the remote configuration file. The configuration file is imported and the device will reboot automatically.

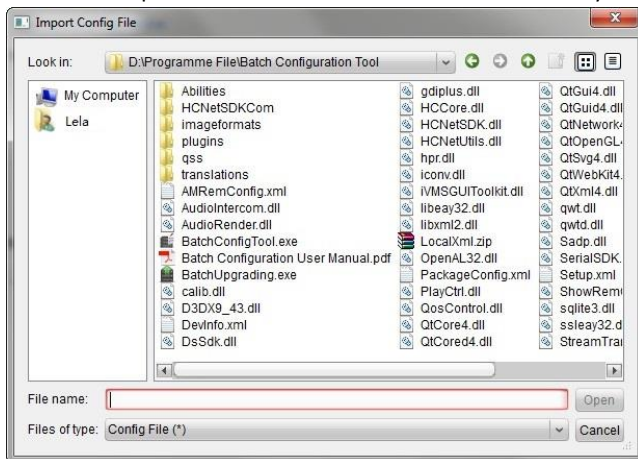

6. Click **Export Configuration File** and the export file window pops up. Select the saving path of remote configuration files and click **Save** to export the configuration file.

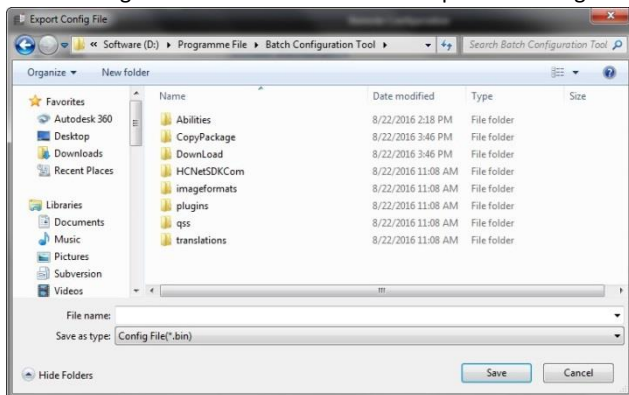

7. Click  to select the upgrade file and click **Upgrade** to remote upgrade the device. The process of remote upgrade will be displayed in the process bar.

Remote Upgrade

Select Type: Upgrade File ▾

Select File: ... Upgrade

Progress:

8. Select a language and click **Save** to change the system language.

Language

English ▾ Save

User

Purpose:

You can edit the password for logging in the device.

Steps:

1. Click the **User** button to enter the user information editing interface.

+ Add ✎ Modify 🗑 Delete

User Name	Priority
admin	Administrator

2. Select the user to edit and click the **Modify** button to enter the user parameter interface.

User Information

User Type: User Name:

Password: Confirm Password:

IP Address: MAC Address:

User Primission

- Local PTZ Control
- Local Manual Recording
- Local Playback
- Local Parameter Settings
- Local Log Search
- Local Advanced Operation
- Local Parameters View
- Local Camera Management
- Local Video Export
- Local Shutdown / Reboot

3. Enter the new password, and confirm it.

STRONG PASSWORD RECOMMENDED– *We highly recommend you create a strong password of your own choosing (Using a minimum of 8 characters, including at least three of the following categories: upper case letters, lower case letters, numbers, and special characters.) in order to increase the security of your product. And we recommend you reset your password regularly, especially in the high security system, resetting the password monthly or weekly can better protect your product.*



4. Click the **Save** button to realize the editing of password.



NOTE

- The new password and confirm password should be identical.
- After editing the password of device, click  button from the device list, the added device will not be there. You should add the device again with new password to operate the remote configuration.

RS485

Click the **RS485** button to enter the RS485 setting interface. You can view and edit the RS485 parameters of the device.

When use RS-485 interface to connect the door station and the card reader, you should set the bitrate as **19200**, and set the working mode as **Card Reader**.

When use RS-485 interface to connect the door station and the elevator controller, you should set the bitrate as **19200** or **38400**, and set the working mode as **Elevator Control**.

When use RS-485 interface to connect the door station and the security door unit, you should set the bitrate as **19200**, and set the working mode as **Access Control Module**.

RS485:	1	▼
Bitrate:	9600	▼
Data Bit:	8	▼
Stop Bit:	1	▼
Parity:	None ▼	
Flow Control:	None ▼	
Working Mode:	Disable ▼	
<input type="button" value="Save"/>		

7.4.2 Video Intercom

Click the **Video Intercom** button on the remote configuration interface to enter the video intercom parameters settings: Device Number Configuration, Time Parameters, Password, Zone Configuration, IP Camera Information, and Volume Input and Output Configuration, and so on.

Device ID Configuration

Steps:

1. Click **ID Configuration** to enter device ID configuration interface.

Device No. Configuration

Device Type: Door Station

Community No.: 1

Building No.: 1

Unit No.: 1

Floor No.: 1

No.: 1

Save

Door Station

Device No. Configuration

Device Type: Outer Door Station

Community No.: 1

No.: 1

Save

Outer Door Station

2. Select the device type from the drop-down list, and set the corresponding information.
3. Click **Save** to enable the device number configuration.



NOTE

- For main door station (D series or V series), the serial No. is 0.
- For sub door station (D series or V series), the serial No. is higher than 0. Serial No. ranges from 1 to 99.
- For each villa or building, at least one main door station (D series or V series) should be configured, and sub door stations (D series or V series) can be customized.
- For one main door station (D series or V series), at most 8 sub door stations can be customized.
- Select doorphone as device type, and the serial No. is not necessary to configure. Please utilize the doorphone along with the main door station (V Series or D Series).

Time Parameters

1. Click **Time Parameters** to enter time parameters settings interface.
2. Configure the maximum ring duration, maximum live view time, and call forwarding time.
3. Click **Save**.

Time Parameters

Device Type: Outer Door Station

Max. Speaking Duration: 90 s

Max. Message Duration: 30 s

Save



NOTE

For door station, maximum speaking time and maximum message time should be configured. Maximum speaking time varies from 90s to 120s, and maximum message time varies from 30s to 60s.

Password

Click **Password** to enter password changing interface.

You can modify the admin password (also called configuration password), public password, and card activation password.

Configuration Password (Admin Password): It is necessary when you want to configure parameters of the door station, such as IP parameters, door station No., system type, and so on.

Card Activation Password: It is necessary when you want to issue cards via password.

Permission Password

Password Type: Admin Password ▼

Old Password:

New Password:

Confirm Password:

Access Control and Elevator

Click **Access Control and Elevator** to enter corresponding configuration page.

Access Control

Delayed Door Alarm

Door No.: 1 ▼

Door-unlocked Dura...: 15 s

Encrypt Card

Elevator Control

Elevator No.: 1 ▼

Elevator Type: XX-XXXXX ▼

Negative Floor: 0

Interface Type: RS485 ▼

Tip: All elevators should use the same interface type.

Enable Or Not: Yes ▼

Access Control

Delayed Door Alarm

Door No.: 1 ▼

Door-unlocked Dura...: 15 s

Encrypt Card

Elevator Control

Elevator No.: 1 ▼

Elevator Type: XX-XXXXX ▼

Negative Floor: 0

Interface Type: Network Interface ▼

Tip: All elevators should use the same interface type.

Enable Or Not: Yes ▼

Server IP Address: 0.0.0.0

Server Port: 0

User Name:

Password:

Access Control

1. Select the door No.
2. Set the door-unlocked duration.

3. (Optional) Enable **Delay Door Alarm**.

4. Click **Save** to enable the settings.



NOTE

- The door-unlocked duration ranges from 1s to 225s.
- If you check **Delayed Door Alarm**, an alarm will be triggered automatically if the door is not locked in the configured duration.
- Enabling **Card Encrypt**, the door station can recognize the encrypted information of the card when you swiping the card on the door station.

Elevator Control

Before you start

- Make sure your door station is in the mode of main door station. Only the main door station support elevator control function.
- Make sure your door station has been connected to the elevator controller via RS-485 wire if you want to use RS-485 interface.

Connection between the door station and the elevator controller supports 2 types: RS-485 or Network interface.

Step:

1. Select an elevator No., and select an elevator controller type for the elevator.
2. Set the negative floor.
3. Select the interface type: RS-485 or Network Interface.

If you select RS-485, please make sure you have connected the door station to the elevator controller with RS-485 wire.

If you select Network Interface, please enter the elevator controller's IP address, port No., user name, and password.

4. Enable the elevator control.



NOTE

- Up to 4 elevator controllers can be connected to one door station.
- Up to 10 negative floors can be added.
- Make sure the interface types of elevator controllers, which are connected to the same door station, are consistent.

IO Input and Output

Step:

1. Click **I/O Input and Output** to enter the I/O input and output interface.

IO Input

IO Input No.: S1

Input: Exit Button

IO Output

IO Output No.: COM1

Output: Electric Lock

Save

2. Select I/O input No., input mode, output No., and output mode.
3. Click **Save** to enable the settings.



NOTE

- For door station (D series), there are 8 I/O Input Terminals. Terminal 1~4 correspond to **SENSOR** interfaces (S1, S2, S3, S4) of door station. Terminal 5~8 correspond to interfaces of **ALARM IN** (A1, A2, A3, A4). You can select an I/O input No. (S1, S2, S3, S4, A1, A2, A3, A4) from the drop-down list and set the I/O input as door magnetic exit button.
- For door station (V series), there are 4 I/O Input Terminals, corresponding to **SENSOR** interfaces (S1, S2, S3, S4) of door station.
- For door station (D series and V series), there are 4 I/O Output Terminals. Terminal 1~2 correspond to **DOOR** interfaces (NO1/COM1/NC1; NO2/COM2/NC2) of door station. You can enable/disable IO Out by selecting from the dropdown list. Terminal 3~4 correspond to interfaces of **ALARM OUT** (AO1+, AO1-; AO2+, AO2-).

Volume Input and Output

Step:

1. Click **Volume Input/Output** to enter the volume input and output interface.

Volume Input

Volume Input: 7

Volume Output

Output Volume: 7

Save

2. Slide the slider to adjust the volume input and volume output.
3. Click **Save** to enable the settings.

Deploy Info

In the Deploy Info interface, you can view which kind of device or client will receive the alarm message and arm message from the door station.

Deploy Info

Refresh

Index	DeployNo	DeployType	IpAddr
1	1	Client Deploy	10.8.96.33

Intercom Protocol

Door station supports the private SIP protocol and the standard SIP protocol. You can change the protocol in the Intercom Protocol interface.

Step:

1. Click **Intercom Protocol** to enter the intercom protocol interface.

2. Select protocol type.
3. Click **Save** to enable the settings.

7.4.3 Network

Local Network Configuration

Steps:

1. Click **Local Network Configuration** to enter local network configuration interface.

2. Enter the local IP address, subnet mask, gateway address, and port No.
3. Click **Save** to enable the settings.



NOTE

- The default port No. is 8000.
- After editing the local network parameters of device, you should add the devices to the device list again.

SIP Configuration

A SIP server connection is required and necessary for the door station to guarantee the connection between the door station and the management center (master station) in the same video intercom system.

2 types of SIP protocol are available for the door station: Private Protocol, and Standard Protocol.



NOTE

- If the door station adopts the private SIP protocol, set the SIP IP address when you edit the network parameters for the door station. See *6.4.2 Edit Network Parameters* for details.
- If the door station adopts the standard SIP, you should set the SIP information via the remote configuration.

Steps:

1. Click **SIPConfig** to enter the standard SIP configuration interface.

Login Status:	Unregistered
Server:	Domain Name ▾
Server Domain:	<input type="text"/>
Server Port:	5060
Login Username:	<input type="text"/>
Login Password:	<input type="text"/>
Local No.:	<input type="text"/>
Display Name:	<input type="text"/>
Login Cycle:	60 Minute(s)
<input type="button" value="Save"/>	

2. Enter the information based your needs.



NOTE

The local No. refers to the VoIP number, and supports up to 16 digits.

Linked Devices Network Configuration

Purpose:

In the linked devices network configuration interface, you can configure the network parameters of master stations, SIP servers and management centers of the same LAN. The devices can be linked to the door station and realize the linkage between these devices.

Steps:

1. Click **Linked Network Configuration** to enter linked network configuration interface.

Linked Network Configuration

Device Type:	Door Station
Master Station IP Address:	0.0.0.0
(Main) Door Station IP Address:	0.0.0.0
SIP Server IP Address:	0.0.0.0
Security Control Panel IP Address:	0.0.0.0
Security Control Panel Port No.:	0
<input type="button" value="Save"/>	

2. Enter the master station IP address, (main) door station IP address, SIP server IP address, management center IP address, and doorphone IP address.
3. Select the main door station type from the drop-down list.
4. Click the **Save** button to enable the settings.



NOTE

- After adding master station IP Address, the linkage between indoor station and master station can be realized.
- After adding the door station IP Address, the video intercom between indoor stations of same building can be realized.
- After adding SIP Server Address IP, the video intercom of same community: video intercom between indoor stations of different building, calling indoor station from outer door station and video intercom between management center and indoors.
- After adding management center IP Address, the events can be uploaded to the management center.
- For indoor extension, only parameter about the main indoor station should be configured.

FTP

Steps:

1. Click the **FTP** button to enter the FTP parameters interface.

Enable Main FTP

Server Type: IP Address

FTP Server: 0.0.0.0

Port: 21

Enable Anonymous:

User Name:

Password:

Directory: Save in the Child Direc...

Parent Directory: Community No.-Buildi...

Child Directory: Enable Time

Picture Naming Rule
Separator: _

Name: Item 1

Named Element: Time

Save

2. Check the checkbox of **Enable Main FTP**.
3. Select IP address from the drop-down list of server mode.
4. Enter the FTP server address, and port No.
5. Check the checkbox to enable the anonymity (optional).
6. Enter the name and password.
7. Select the directory structure and set the separator, naming item, and naming element.
8. Click the **Save** button to enable the FTP parameters settings.



NOTE

- The default port No. is 21.
- To enable anonymity or not is according to whether the FTP server enables anonymity.
- After configuring the FTP parameters, the captured pictures of door station will be uploaded to the FTP server automatically.
- This function only applies to the door station, except for the doorphone.

Advanced Settings

Steps:

1. Click the **Advanced Settings** button to enter the advanced network settings interface.

Configuring the Advanced Network Settings

DNS Server Address1:

DNS Server Address2:

2. Enter the DNS server addresses.
3. Click the **Save** button to enable the advanced network settings.

7.4.4 Video Display

Steps:

1. Click the **Video Display** button to enter the video parameters interface.

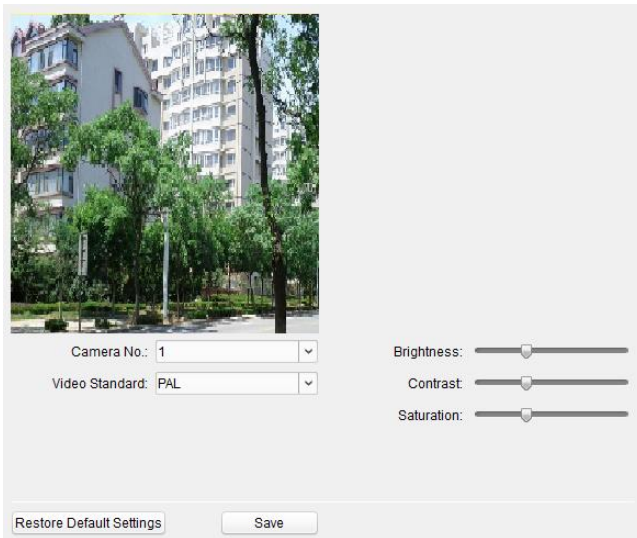

Camera No.:

Video Standard:

Brightness:

Contrast:

Saturation:

2. Select the camera No.
3. Select the video standard (PAL and NTSC can be selected).
4. Set the brightness, contrast, and saturation of the video.
5. Click the **Save** button to enable the settings.

NOTE

Click the **Restore Default Settings** button to restore all parameters excluding network parameters to the factory settings.

7.5 Video Intercom Device Set-up Tool

Purpose:

You can assign the device to the community, activate and set the device, and configure the network parameters and linked network parameters for the device by using the video intercom device set-up tool.

In the device list area, click **Flash rom** to enter the video intercom device set-up tool.

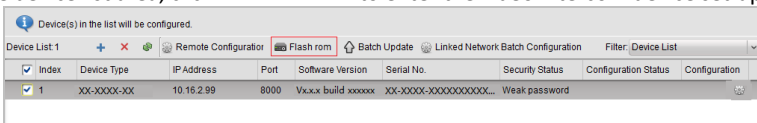

7.5.1 Set a Community Structure

Set a community structure in the video intercom device set-up tool first, based on the real community situation, and then assign devices to the community accordingly.

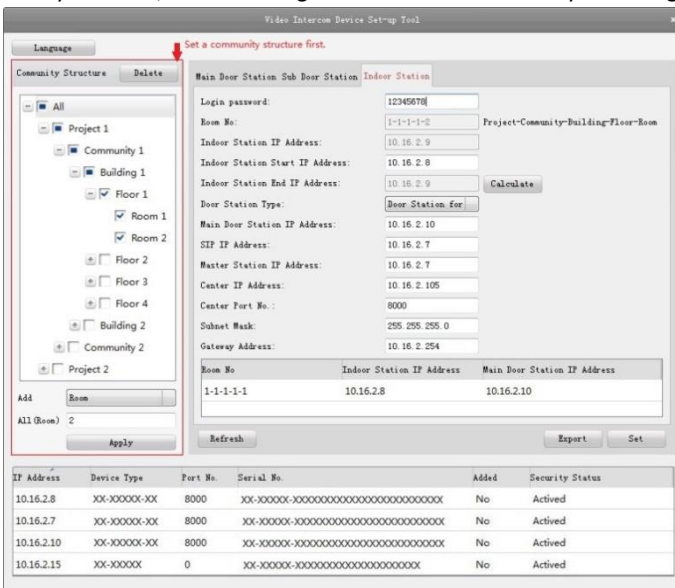

7.5.2 Set Main/Sub Door Station

Set Main Door Station

Purpose:

You can activate the online main door station, and configure the Project building No. for the online main door station.

Steps:

1. Select the community, and press the **Main Door Station** tab to switch to the main door station configuration interface.

The screenshot shows the 'Video Intercom Device Setup Tool' window. On the left is the 'Community Structure' tree with 'Project 1 -> Community 1 -> Building 1 -> Floor 1 -> Room 2' selected. The main area has three tabs: 'Main Door Station' (active), 'Sub Door Station', and 'Indoor Station'. The 'Main Door Station' tab contains the following fields:

- Door Station for: [Dropdown menu]
- Login password: [Masked field]
- Main Door Station: [1-1-1] (Project-Community-Building)
- Main Door Station Floor No.: [1]
- Main Door Station IP Address: [10.16.2.99]
- Main Door Station Start IP Address: [10.16.2.99]
- Main Door Station End IP Address: [10.16.2.99] (with Calculate button)
- SIP IP Address: [10.16.2.17]
- Master Station IP Address: [10.16.2.17]
- Center IP Address: [10.16.2.17]
- Center Port No.: [8000]
- Subnet Mask: [255.255.255.0]
- Gateway Address: [10.16.2.254]

At the bottom, there is a table of installed devices:

IP Address	Device Type	Port No.	Serial No.	Added	Security Status
10.15.4.164	XX-XXXX-XX	8000	XX-XXXX-XXXXXXXXXXXXXXXXXXXXXXXXXX	No	Activated
10.15.4.245	XX-XXXX-XX	8000	XX-XXXX-XXXXXXXXXXXXXXXXXXXXXXXXXX	No	Activated
10.15.4.243	XX-XXXX-XX	8000	XX-XXXX-XXXXXXXXXXXXXXXXXXXXXXXXXX	No	Activated
10.15.4.181	XX-XXXX-XX	8000	XX-XXXX-XXXXXXXXXXXXXXXXXXXXXXXXXX	No	Activated

2. Select the door station type from the drop-down list menu: Door Station for Unit, or Door Station for Villa.
3. Enter the main door station start IP address, set the main door station floor No., and then click the **Calculate** button to generate the main door station end IP address and main door station No. (like 1-1-1) automatically.
4. Set the linked network parameters for the main door station: SIP IP address, master station IP address, center IP address, center port No., subnet mask, and gateway address.
5. Select an online door station, enter the login password, and click the **Set** button.



NOTE

- The default main door station floor No. is 1.
- For the login password, if the main door station has been activated, enter the activation password here. If the main door station is not activated, create a login password here, and the main door station will be activated simultaneously.
- When the device is successfully configured, it prompts the note: Configuring main door station parameters succeeded.

Set Sub Door Station

Steps:

1. Select the community, and press the **Sub Door Station** tab to switch to the sub door station configuration interface.

The screenshot shows the 'Video Intercom Device Setup Tool' interface. On the left, the 'Community Structure' tree shows a hierarchy: All > Project 1 > Community 1 > Building 1 > Floor 1 > Room 2 (selected). Below the tree are 'Add' and 'All (Project)' buttons. The main configuration area has three tabs: 'Main Door Station', 'Sub Door Station' (active), and 'Indoor Station'. The 'Sub Door Station' form includes fields for:

- Door Station for: [Dropdown menu]
- Login password: [Masked field]
- Sub Door Station: [1-1-1]
- Sub Door Station Floor No.: [1]
- Sub Door Station IP Address: [10.15.4.23]
- Sub Door Station Amount: [1]
- Sub Door Station Start IP Address: [10.15.4.23]
- Sub Door Station End IP Address: [10.15.4.23] with a 'Calculate' button.
- Main Door Station IP Address: [10.15.4.24]
- SIP IP Address: [10.15.4.25]
- Master Station IP Address: [10.15.4.25]
- Center IP Address: [10.15.4.25]
- Center Port No.: [8000]
- Subnet Mask: [255.255.255.0]
- Gateway Address: [10.15.4.254]

 At the bottom, there is a table of installed devices:

IP Address	Device Type	Port No.	Serial No.	Added	Security Status
10.15.4.162	DS-KM8301	8000	DS-KM83010120170214WR647297179CLU	No	Activated
10.15.4.178	DS-KH6300-A	8000	DS-KH6300-A0120170217CH677436124CLU	No	Activated
10.15.4.245	DS-KM8301	8000	DS-KM83010120161210CH693065507CLU	No	Activated
10.15.4.225	DS-KD8102-2	8000	DS-KD8102-20120161203CH622550084CLU	No	Activated

2. Select the door station type from the drop-down list menu: Door Station for Unit, or Door Station for Villa.
3. Set the sub door station parameters (sub door station amount, floor No., start IP address, end IP address), and then click the **Calculate** button to generate the sub door station end IP address and sub door station No. (like 1-1-1-1) automatically.

- Set the linked network parameters for the sub door station: main door station IP address, SIP IP address, master station IP address, center IP address, center port No., subnet mask, and gateway address.
- Select an online door station, enter the login password, and click the **Set** button.



NOTE

- The default sub door station floor No. is 1.
- Up to 8 sub door stations can be added to a main door station.
- For the login password, if the sub door station has been activated, enter the activation password here. If the sub door station is not activated, create a login password here, and the sub door station will be activated simultaneously.
- When the device is successfully configured, it prompts the note: Configuring main door station parameters succeeded

7.6 Batch Upgrading

In the device list area, click **Batch Update** to enter the batch upgrading interface.

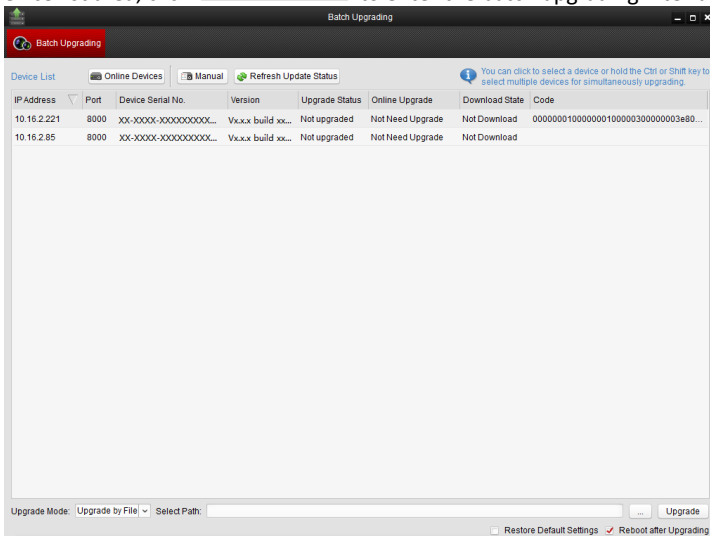

7.6.1 Add Devices for Upgrading

You should add the device to the batch upgrading tool first before upgrading the device. There are 2 ways to add the device: adding online device, and adding by IP address/IP segment.

Add Online Device

Steps:

1. In the batch upgrading interface, click the  **Online Devices** to open the online device window.

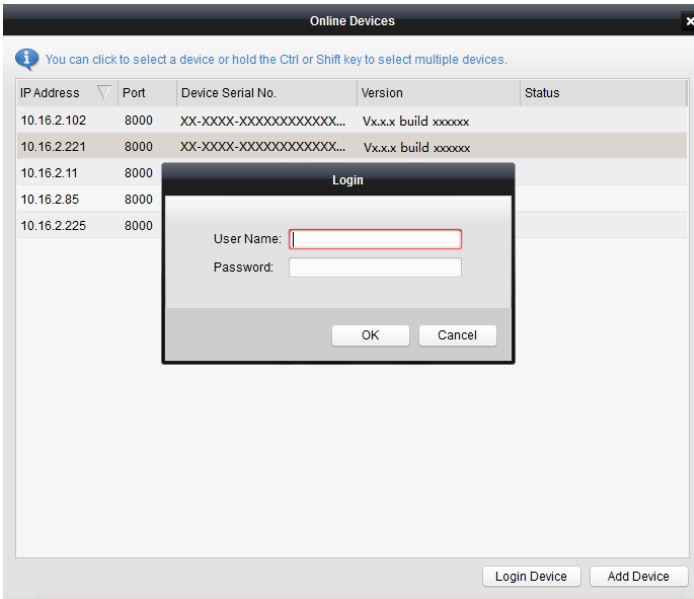

2. Select a device, enter the user name and password, and click the **Login Device** button.
3. Click the **Add Device** button, and the device is added to the batch upgrading tool.

The screenshot shows a window titled "Online Devices" with a close button (X) in the top right corner. Below the title bar is a blue information icon and a message: "You can click to select a device or hold the Ctrl or Shift key to select multiple devices." Below this is a table with the following columns: IP Address, Port, Device Serial No., Version, and Status. The table contains five rows of data. At the bottom right of the window are two buttons: "Login Device" and "Add Device".

IP Address	Port	Device Serial No.	Version	Status
10.16.2.102	8000	XX-XXXX-XXXXXXXXXXXX...	Vk.x.x build xxxxxxx	
10.16.2.221	8000	XX-XXXX-XXXXXXXXXXXX...	Vk.x.x build xxxxxxx	Added
10.16.2.11	8000	XX-XXXX-XXXXXXXXXXXX...	Vk.x.x build xxxxxxx	
10.16.2.85	8000	XX-XXXX-XXXXXXXXXXXX...	Vk.x.x build xxxxxxx	Logged in
10.16.2.225	8000	XX-XXXX-XXXXXXXXXXXX...	Vk.x.x build xxxxxxx	

Add by IP Address/IP Segment

Steps:

1. Click the **Manual** button to open the device adding window.
2. Enter the corresponding information (IP address, user name, password, start IP address, end IP address).
3. Click the **Add** button.

The screenshot shows a dialog box titled "Search" with a close button (X) in the top right corner. It is divided into two sections: "By IP" and "By IP Segment".

By IP

IP Address:

Port:

User Name:

Password:

By IP Segment

Start IP:

End IP:

Port:

User Name:

Password:

7.6.2 Upgrade Devices

Door station supports upgrading by file.

Upgrading by File: You upgrade the device or devices via the local upgrade files.

Steps:

1. Select a device or multiple devices, and select “Upgrade by File” as the upgrading mode.
2. Click  to pop up the window for opening the upgrading file.

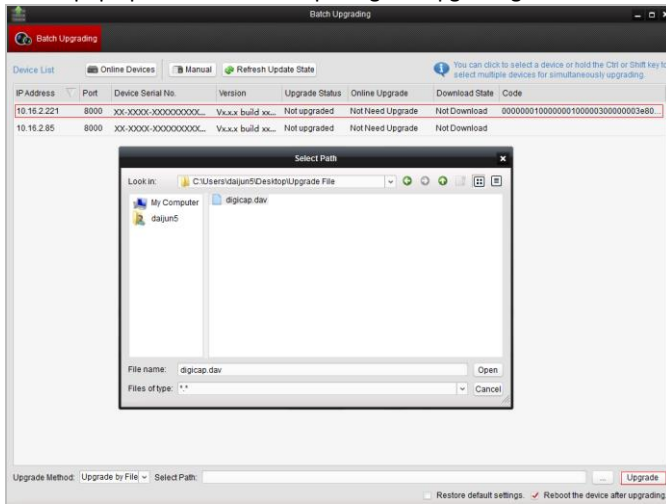

3. Open the upgrading file, and click the **Upgrade** button.

8 Remote Operation via iVMS-4200

The Video Intercom module provides remote control and configuration on video intercom products via the iVMS-4200 client software.

8.1 System Configuration

Purpose:



You can configure the video intercom parameters accordingly.

Steps:

1. Open the System Configuration page.

Path: **Control Panel -> Maintenance and Management -> System Configuration -> Video Intercom.**

2. Click the **Video Intercom** to enter the Video Intercom Settings interface.
3. Input the required information.

Ringtone: Click the icon  and select the audio file from the local path for the ringtone of indoor station. Optionally, you can click the icon  for a testing of the audio file.

Max. Ring Duration: Input the maximum duration of the ringtone, ranging from 15 seconds to 60 seconds.

Max. Speaking Duration with Indoor Station: Input the maximum duration of speaking with the indoor station, ranging from 120 seconds to 600 seconds.

Max. Speaking Duration with Door Station: Input the maximum duration of speaking with the door station, ranging from 90 seconds to 120 seconds.

4. Click **Save** to save the settings.

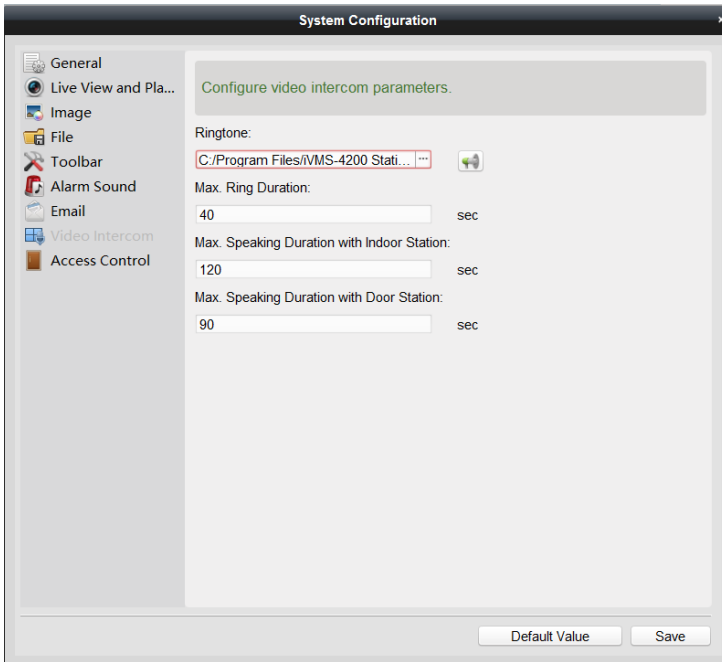

8.2 Device Management

Purpose:

Device management includes device activation, adding device, editing device, and deleting device, and so on.

After running the iVMS-4200, video intercom devices should be added to the client software for remote configuration and management.

8.2.1 Add Video Intercom Devices



NOTE

- You can add at most 512 indoor stations and master stations in total to the iVMS-4200, and add at most 16 door stations to the iVMS-4200.
- For video intercom devices, you are required to create the password to activate them before they can be added to the software and work properly. For device activation via creating password, please refer *User Manual of iVMS-4200 (Video Intercom) V2.4.2* in the disk for detail steps.
- You can add online video intercom devices, and add them manually. Here take adding online video intercom devices as example. For adding video intercom devices

Add

Adding Mode:

IP/Domain IP Segment Hik-Connect... EHome Serial Port

IP Server HiDDNS Batch Import

Add Offline Device

Nickname: Video Intercom Device

Address: 10.7.112.122

Port: 8000

User Name: admin

Password: ●●●●●●

Export to Group

Set the device name as the group name and add all the channels connected to the device to the group.

Add Cancel

**NOTE****Add Multiple Online Devices**

If you want to add multiple online devices to the client software, click and hold Ctrl key to select multiple devices, and click **Add to Client** to open the device adding dialog box. In the pop-up message box, enter the user name and password for the devices to be added.

Add All the Online Devices

If you want to add all the online devices to the client software, click Add All and click **OK** in the pop-up message box. Then enter the user name and password for the devices to be added.

8.2.2 Modify Network Information

Select the device from the online list, click **Modify Netinfo**, and then you can modify the network information of the selected device.

**NOTE**

You should enter the admin password of the device in the **Password** field of the pop-up window to modify the parameters.

8.2.3 Reset Password

According to the different video intercom devices, the software provides two different methods for restoring the default password or resetting the password.

Select the device from the online device list, click **Reset Password**.

Option 1:

If the window with import file button, key importing mode drop-down list, password and confirm password field pops up, follow the steps below to reset the password:

**NOTE**

This option is available to door stations.

1. Click **Export** to save the device file on your computer.
2. Send the file to our technical engineers.
3. Our technical engineer will send you a file to you. After receiving a file from the technical engineer, select **Import File** from Key Importing Mode drop-down list and click  to import the file.
4. Input new password in text fields of **Password** and **Confirm Password**.
5. Click **OK** to reset the password.

STRONG PASSWORD RECOMMENDED– *We highly recommend you create a strong password of your own choosing (Using a minimum of 8 characters, including at least three of the following categories: upper case letters, lower case letters, numbers, and special characters.) in order to increase the security of your product. And we recommend you reset your password regularly, especially in the high security system, resetting the password monthly or weekly can better protect your product.*



Option 2:

If the window with import file and export file buttons, password and confirm password field pops up, follow the steps below to reset the password:



NOTE

This option is available to indoor stations and master stations.

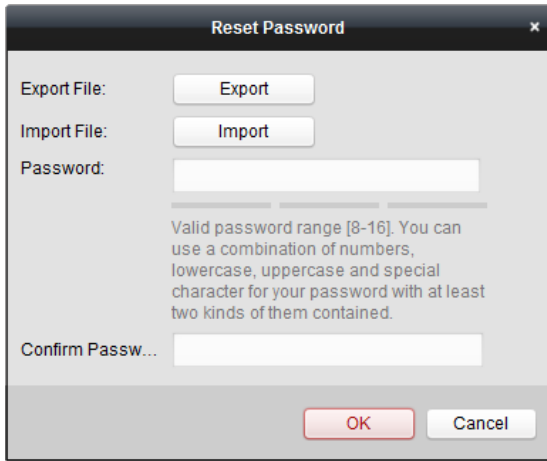

1. Click **Export** to save the device file on your computer.
2. Send the file to our technical engineers.
3. Click **Import** and select the file received from the technical engineer.
4. Input new password in text fields of **Password** and **Confirm Password**.
5. Click **OK** to reset the password.

STRONG PASSWORD RECOMMENDED— *We highly recommend you create a strong password of your own choosing (Using a minimum of 8 characters, including at least three of the following categories: upper case letters, lower case letters, numbers, and special characters.) in order to increase the security of your product. And we recommend you reset your password regularly, especially in the high security system, resetting the password monthly or weekly can better protect your product.*



8.3 Remote Configuration

Configuring devices remotely via iVMS-4200 is the same with that via Batch Configuration Tool, please refer 7.4 *Configure Devices Remotely* for detail steps.

8.4 Person and Card Management

Purpose:

You can add, edit, and delete the organization and person in Person and Card Management module. Organization and person management is necessary for the video intercom function.

Before you start:

For the first time opening the Access Control module, the following dialog will pop up and you are required to select the scene according to the actual needs. You can select the scene as **Non-residence** and **Residence**.

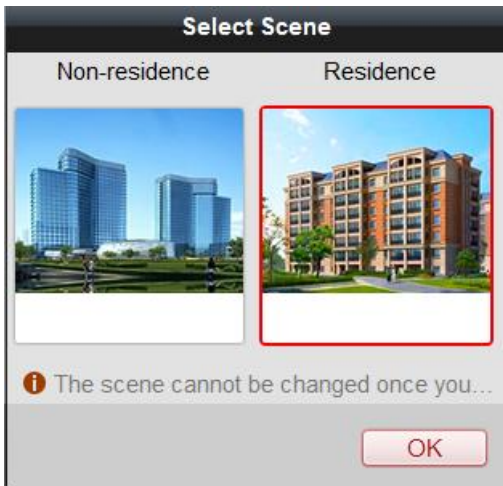

NOTE

Once the scene is configured, you cannot change it later.



Click -> tab to enter the Person and Card Management interface.

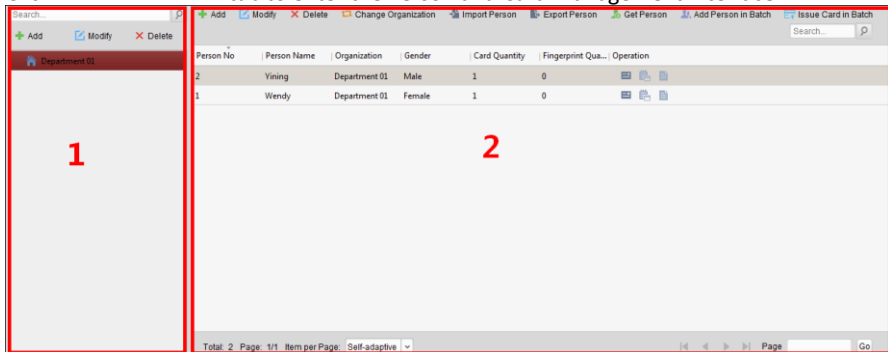

The interface is divided into two parts: Organization Management and Person Management.

1	Organization Management	You can add, edit, or delete the organization as desired.
2	Person Management	After adding the organization, you can add the

		person to the organization and issue card to persons for further management.
--	--	------------------------------------------------------------------------------

8.4.1 Organization Management

Add Organization

Steps:

1. In the organization list on the left, you should add a top organization as the parent organization of all organizations.

Click **Add** button to pop up the adding organization interface.

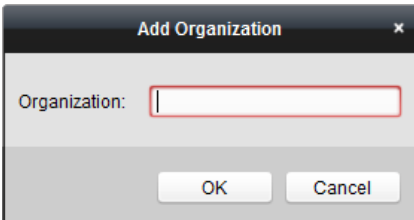

2. Input the Organization Name as desired.
3. Click **OK** to save the adding.
4. You can add multiple levels of organizations according to the actual needs.

To add sub organizations, select the parent organization and click **Add**.

Repeat *Step 2* and *3* to add the sub organization.

Then the added organization will be the sub-organization of the upper-level organization.



NOTE

Up to 10 levels of organizations can be created.

Modify and Delete Organization

You can select the added organization and click **Modify** to modify its name.

You can select an organization, and click **Delete** button to delete it.



NOTE

- The lower-level organizations will be deleted as well if you delete an organization.
- Make sure there is no person added under the organization, or the organization cannot be deleted.

8.4.2 Person Management

After adding the organization, you can add person to the organization and manage the added person such as issuing cards in batch, importing and exporting person's information in batch, etc.



NOTE

Up to 10,000 persons or cards can be added.

Add Person

Person information is necessary for the video intercom system. And when you set linked device for the person, the intercom between intercom devices can be realized.

Steps:

1. Select an organization in the organization list and click **Add** on the Person panel to pop up the adding person dialog.



NOTE

The Person No. will be generated automatically and is not editable.

Add Person
x

Person No.: *

Person Name: *

Gender: Male Female *

Phone No.:

Date of Birth:

Place of Birth:

Email:

Details
 Permission
 Card
 Fingerprint
 Attendance Rule

ID Type: Country:

ID No.: City:

Job Title: Degree:

On Board Date: Employment Duration:

Linked Device:

Room No.:

Address:

Remark:

2. Set basic person information.
 - 1) Enter basic information: person name, phone No., birthday details, and email address.
 - 2) (Optional) Click **Upload Picture** to select the person picture from the local PC to upload it to the client.



NOTE

The picture should be in *.jpg format.

- 3) (Optional) You can also click **Take Phone** to take the person's photo with the PC camera.
3. Set linked device for the person.
 - 1) Click **Details**.

Details		Permission	Card	Fingerprint	Attendance Rule
ID Type:	ID	Country:			
ID No.:		City:			
Job Title:		Degree:		Junior High School Diploma	
On Board Date:	2017-01-18	Employment Duration:	10		
Linked Device:					
Room No.:					
Address:					
Remark					

- 2) Set the linked devices
 - **Linked Device:** You can bind the indoor station to the person.



NOTE

If you select **Analog Indoor Station** in the Linked Device, the **Door Station** field will display and you are required to select the door station to communicate with the analog indoor station.

- **Room No.:** You can enter the room No. of the person.

- 3) Click **OK** to save the settings.
4. Issue the card for the person.
 - 1) Click **Card**.

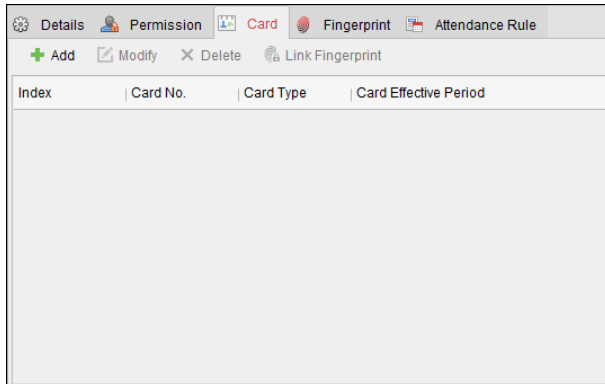

- 2) Click **Add** to pop up the Add Card dialog.

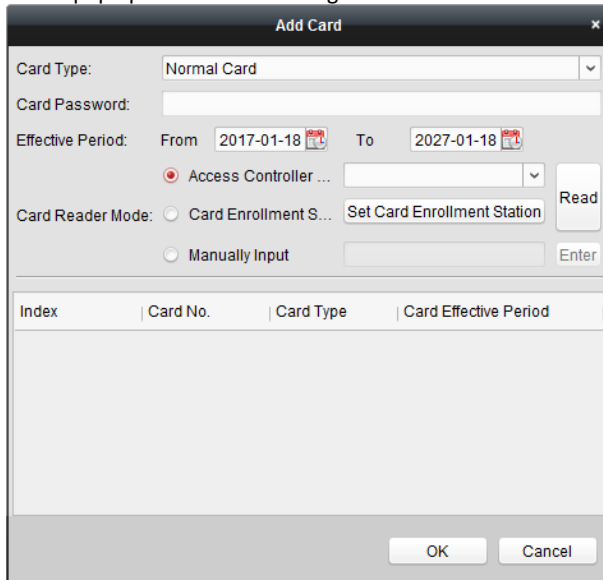

- 3) Select **Normal Card**.
- 4) Enter the password of the card itself in the Card Password field. The card password should contain 4 to 8 digits.
- 5) Enter Card Number manually.
- 6) Click **OK** and the card(s) will be issued to the person.

Import and Export Person Information

The person information can be imported and exported in batch.

Steps:

1. **Exporting Person:** You can export the added persons' information in Excel format to the local PC.
 - 1) After adding the person, you can click **Export Person** button to pop up the following dialog.
 - 2) Click  to select the path of saving the exported Excel file.
 - 3) Check the checkboxes to select the person information to export.

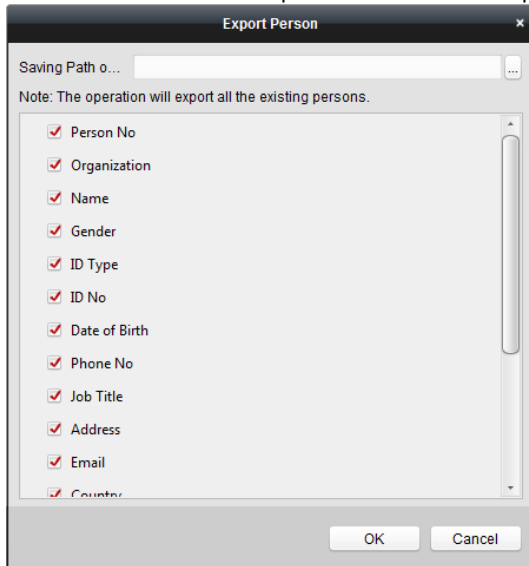

- 4) Click **OK** to start exporting.
2. **Importing Person:** You can import the Excel file with persons information in batch from the local PC
 - 1) click **Import Person** button.

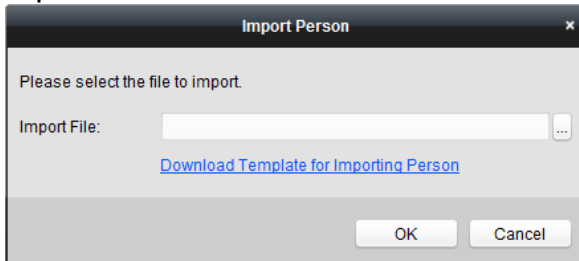

- 2) You can click **Download Template for Importing Person** to download the template first.
- 3) Input the person information to the downloaded template.
- 4) Click  to select the Excel file with person information.

- 5) Click **OK** to start importing.

Get Person Information from Device

If the added device has been configured with person information (including person details, fingerprint, issued card information), you can get the person information from the device and import to the client for further operation.



NOTE

This function is only supported by the device the connection method of which is TCP/IP when adding the device.

Steps:

1. In the organization list on the left, click to select an organization to import the persons.
2. Click **Get Person** to pop up the following dialog box.

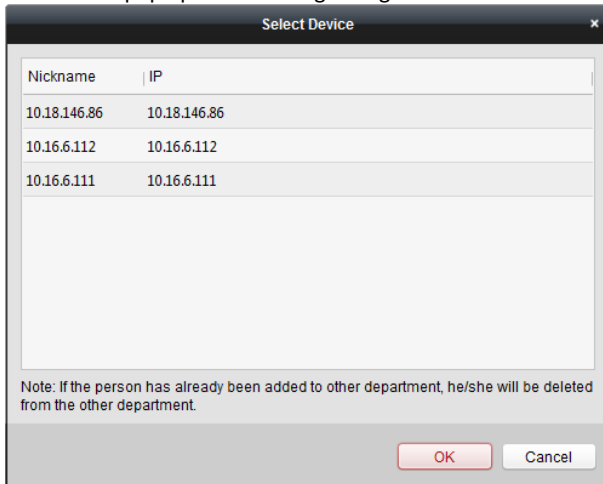

3. The added access control device will be displayed.
4. Click to select the device and then click **OK** to start getting the person information from the device.



You can also double click the device name to start getting the person information.



NOTE

- The person information, including person details, person's fingerprint information (if configured), and the linked card (if configured), will be imported to the selected organization.
- If the person name stored in the device is empty, the person name will be filled with the issued card No. after importing to the client.

Modify and Delete Person

To modify the person information and attendance rule, click  or  in the Operation column, or select the person and click **Modify** to open the editing person dialog.

You can click  to view the person's card swiping records.

To delete the person, select a person and click **Delete** to delete it.



NOTE

If a card is issued to the current person, the linkage will be invalid after the person is deleted.

Change Person to Other Organization

You can move the person to another organization if needed.

Steps:

1. Select the person in the list and click **Change Organization** button.

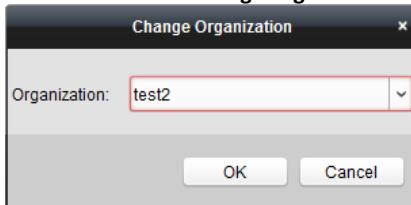

2. Select the organization to move the person to.
3. Click **OK** to save the settings.

Issue Card in Batch

You can issue multiple cards for the person with no card issued in batch.

Steps:

1. Click **Issue Card in Batch** to enter the following dialog.
All the added person with no card issued will display in the Person(s) with No Card Issued list.

Issue Card in Batch

Card Type: Normal Card

Card Password:

Card Quantity: 1

Effective Period: From 2017-01-18 To 2027-01-18

Access Controller Reader

Card Enrollment Station

Manually Input

Person(s) with No Card Issued			Person(s) with Card Issued			
Person Name	Gender	Department	Person Name	Card No.	Gender	Depart
Wendy	Female	Department 1				
Cindy	Female	Department 1/Sub Depar...				

2. Select **Normal Card**.
3. Enter the password of the card itself in the Card Password field. The card password should contain 4 to 8 digits.
4. Enter the card quantity issued for each person.
For example, if the Card Quantity is 3, you can read or enter three card No. for each person.
5. Click  to set the effective time and expiry time of the card.
6. Set the card No.
7. After issuing the card to the person, the person and card information will display in the Person(s) with Card Issued list.
8. Click **OK** to save the settings.

8.5 Video Intercom

Purpose:

The Video Intercom Management module provides the function of video intercom, checking call logs and managing notice via the iVMS-4200 client software.





NOTE

For the user with access control module permissions, the user can enter the Access Control module and manage video intercom and search information.

Before you start:

Before you can remote control the video intercom, you should add the device to the software and configure the person to link the device in the Access Control module.

Click  ->  tab on the left icon bar to enter the Video Intercom interface.

8.5.1 Receive Call from Indoor Station/Door Station

Steps:

1. Select the client software in the indoor station or door station interface to start calling the iVMS-4200 and an incoming call dialog will pop up in the client software.

Here we take the **indoor station** as an example.

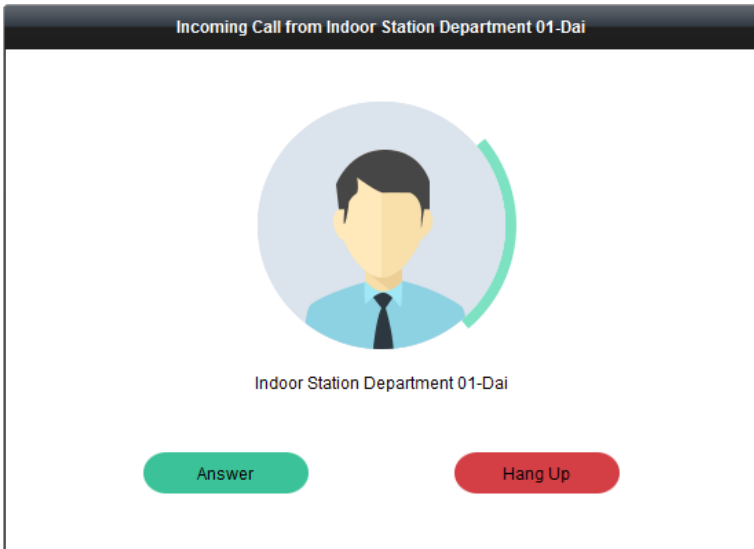

2. Click **Answer** to answer the call.
Or click **Hang Up** to decline the call.
3. After you answer the call, you will enter the In Call window.

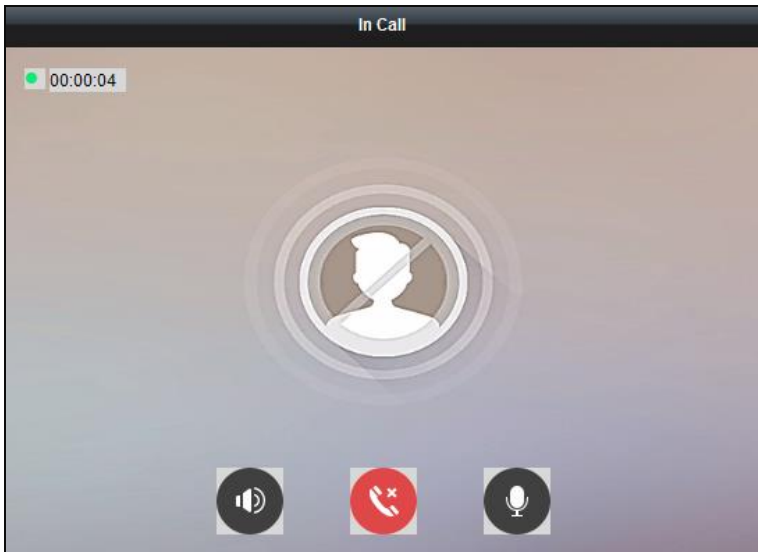

Click  to adjust the volume of the loudspeaker.

Click  to hang up.

Click  to adjust the volume of the microphone.

For door station, you can click  to open the door remotely.



NOTE

- One video intercom device can only connect with one client software.
- The maximum ring duration can be set from 15s to 60s via the Remote Configuration of the video intercom device.
- The maximum speaking duration between indoor station and iVMS-4200 can be set from 120s to 600s via the Remote Configuration of indoor station.
- The maximum speaking duration between door station and iVMS-4200 can be set from 90s to 120s via the Remote Configuration of door station.

8.5.2 View Live Video of Door Station and Outer Door Station

You can get the live view of the door station and outer door station in the Main View module and control the door station and outer door station remotely.

In the Main View module, double-click a door station or outer door station device or drag the device to a display window to start the live view.

Video Intercom Door Station • User Manual

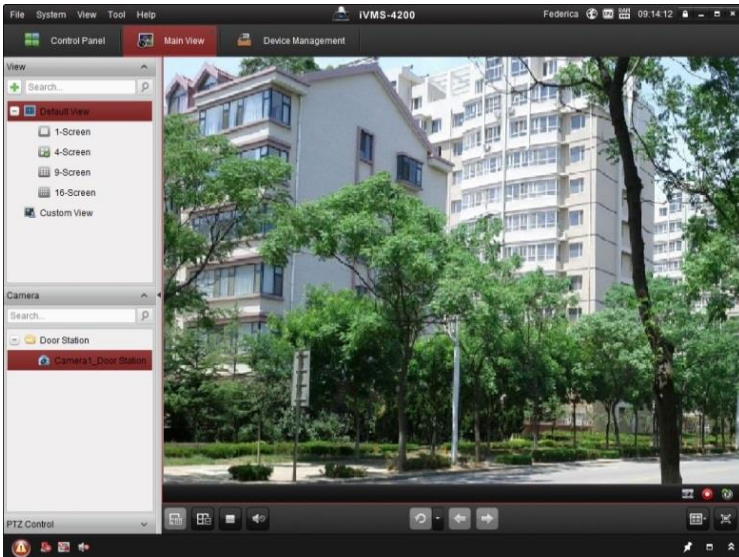

Right click on the live view interface to display the menu and select **Unlock** to remote unlock the door.

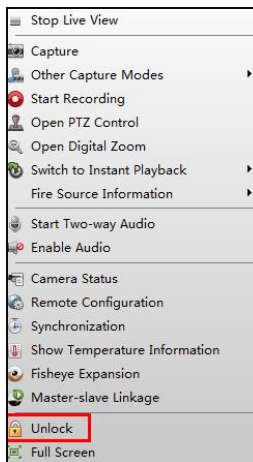

8.5.3 View Call Logs



Purpose:

You can check all the call logs, including dialed call logs, received call logs and missed call logs. You can also directly dial via the log list and clear the logs.

Steps:

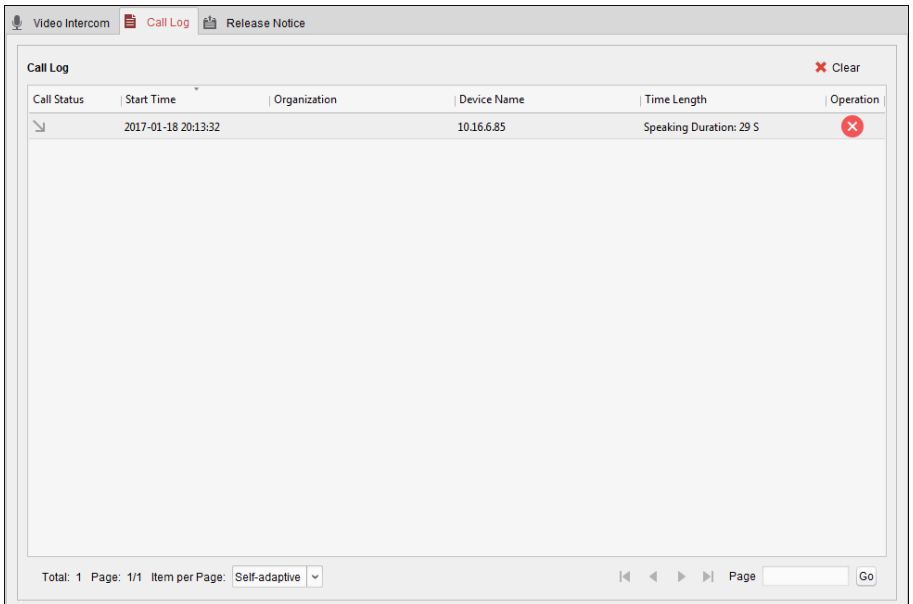
1. In the Video Intercom page, click the **Call Log** tab to enter the Call Log page.
All the call logs will display on this page and you can check the log information, e.g., call status, start time, resident's organization and name, device name and ring or speaking duration.



2. (Optional) Click the icon  in the Operation column to re-dial the resident.
3. (Optional) Click the icon  in the Operation column to delete the call log.
Or you can click **Clear** at the upper right corner to clear all the logs.

8.5.4 Release Notice

Purpose:

You can create different types of notices and send them to the residents. Four notice types are available, including Advertising, Property, Alarm and Notice Information.

Steps:

1. In the Video Intercom page, click **Release Notice** to enter the Release Notice page.

The screenshot shows a software interface with a top navigation bar containing 'Video Intercom', 'Call Log', and 'Release Notice'. The main area is split into two panels. The left panel has a 'New Notice' button and a large empty rectangular area. The right panel contains a form with the following fields and controls:

- Send To:** A text input field with a green plus icon on the right.
- Subject:** A text input field.
- Type:** A dropdown menu currently set to 'Advertising Information'.
- Picture:** An 'Add Picture' button.
- Content:** A large empty text area.
- At the bottom of the right panel are 'Send' and 'Clear' buttons.

2. Click **New Notice** on the left panel to create a new notice.
3. Edit the notice on the right panel.
 - 1) Click icon  on the Send To field to pop up the Select Resident dialog.

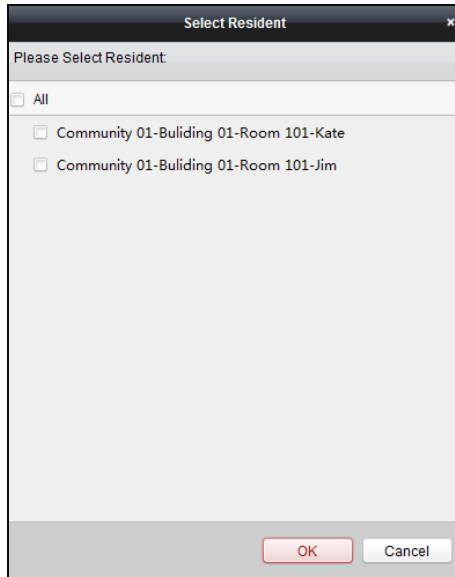

- 2) Check the checkbox(es) to select the resident(s).
Or you can check the **All** checkbox to select all the added residents.
- 3) Click **OK** to save the selection.
- 4) Enter the subject on the Subject field.



NOTE

Up to 63 characters are allowed in the Subject field.

- 5) Click in the Type field to unfold the drop-down list and select the notice type.
- 6) (Optional) Click **Add Picture** to add a local picture to the notice.



NOTE

Up to 6 pictures in the JPGE format can be added to one notice. And the maximum size of one picture is 512KB.

- 7) Enter the notice content in the Content field.
(Optional) You can also click **Clear** to clear the edited content.



NOTE

Up to 1023 characters are allowed in the Content field.

4. Click **Send** to send the edited notice to the selected resident(s).
The sent notice information will display on the left panel. You can click a notice to view the details on the right panel.

8.5.5 Search Video Intercom Information

Purpose:

You can search the call logs between the iVMS-4200 client software and video intercom devices, device unlocking logs and the security notice information.

In the Access Control module, click icon  tab to open the Search page.



Search Call Logs

Steps:

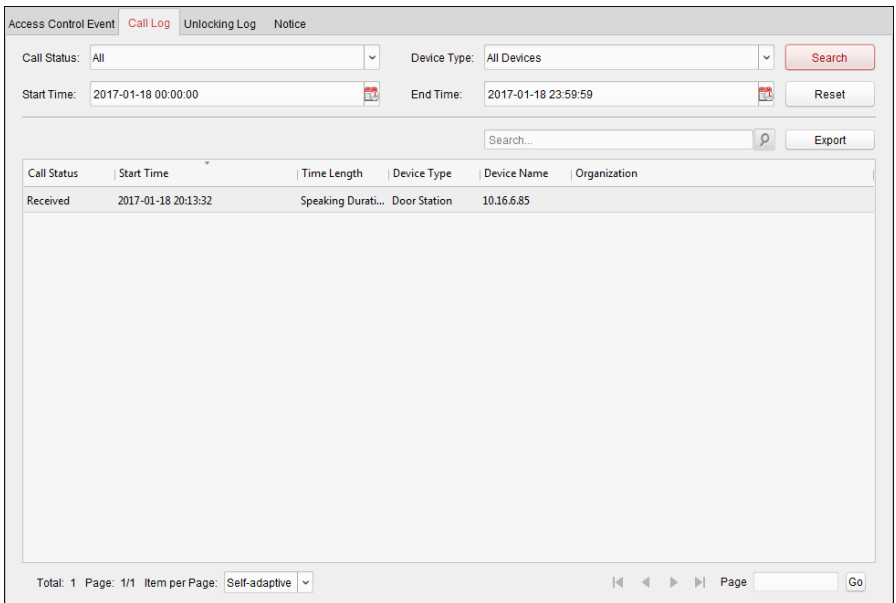
1. In the Information Search page, click the **Call Log** to enter the Call Log interface.



Call Status	Start Time	Time Length	Device Type	Device Name	Organization
Received	2017-01-18 20:13:32	Speaking Durati...	Door Station	10.16.6.85	

2. Set the search conditions, including call status, device type, start time and end time.
 - **Call Status:** Click  to unfold the drop-down list and select the call status as **Dialed**, **Received** or **Missed**. Or select **All** to search logs with all statuses.
 - **Device Type:** Click  to unfold the drop-down list and select the device type as **Indoor Station**, **Door Station**, **Outer Door Station** or **Analog Indoor Station**. Or select **All Devices** to search logs with all device types.
 - **Start Time/End Time:** Click  to specify the start time and end time of a time period to search the logs.
(Optional) You can click **Reset** to reset all the configured search conditions.

- Click **Search** and all the matched call logs will display on this page.

For the search results,

- (Optional) Check the detailed information of searched call logs, such as call status, ring/speaking duration, device name, resident organization, etc.
- (Optional) Input keywords in the Search field to filter the desired log.
- (Optional) Click **Export** to export the call logs to your PC.

Search Unlocking Logs

Steps:

- In the Information Search page, click **Unlocking Log** tab to enter the Unlocking Log interface.

The screenshot displays the 'Unlocking Log' search interface. At the top, there are four tabs: 'Access Control Event', 'Call Log', 'Unlocking Log' (which is active), and 'Notice'. Below the tabs, there are four search criteria: 'Unlocking Type' (set to 'All'), 'Device Type' (set to 'All Devices'), 'Start Time' (set to '2017-01-18 00:00:00'), and 'End Time' (set to '2017-01-18 23:59:59'). There are 'Search', 'Reset', and 'Export' buttons. A search input field with a magnifying glass icon and an 'Export' button are also present. Below the search form is a table with the following columns: 'Time', 'Unlocking Type', 'Device Type', 'Card No./Devic...', and 'Capture'. The table is currently empty. At the bottom, there is a status bar showing 'Total: 0 Page: 1/1 Item per Page: Self-adaptive' and navigation controls.

- Set the search conditions, including unlocking type, device type, start time and end time.
 - **Unlocking Type:** Click to unfold the drop-down list and select the unlocking type as **Unlock by Password**, **Unlock by Duress**, **Unlock by Card**, **Unlock by Resident** or **Unlock by Center**. Or select **All** to search logs with all unlocking types.
 - **Device Type:** Click to unfold the drop-down list and select the device type as **Door Station** or **Door Station (V Series)**. Or select **All Devices** to search logs with all device types.

- **Start Time/End Time:** Click  to specify the start time and end time of a time period to search the logs.
3. (Optional) You can click **Reset** to reset all the configured search conditions.
 4. Click **Search** and all the matched unlocking logs will display on this page.

For the searching results,

- (Optional) Check the detailed information of searched unlocking logs, such as unlocked time, card No., device No., etc.
- (Optional) Input keywords in the Search field to filter the searching result.
- (Optional) Click  in the Capture column to view the captured pictures.



NOTE

Viewing captured picture should be supported by device.



- (Optional) Click **Export** to export the unlocking logs to your PC.

Search Notice

Steps:

1. In the Information Search page, click the **Notice** tab to enter the Notice interface.

2. Set the search conditions, including notice type, subject, recipient, start time and end time.

- **Notice Type:** Click  to unfold the drop-down list and select the notice type as **Advertising Information, Property Information, Alarm Information** or **Notice Information**. Or select **All** to search notices with all types.
 - **Subject:** Input the keywords in the Subject field to search the matched notice.
 - **Recipient:** Input the recipient information in the Recipient field to search the specified notice.
 - **Start Time/End Time:** Click  to specify the start time and end time of a time period to search the notices.
(Optional) You can click **Reset** to reset all the configured search conditions.
3. Click **Search** and all the matched notices will display on this page.
- For the searching results,
- (Optional) Check the detailed information of searched notices, such as sending time, sending status, etc.
 - (Optional) Input keywords in the Search field to filter the searching result.
 - (Optional) Click  in the Operation column to pop up Notice Details dialog.

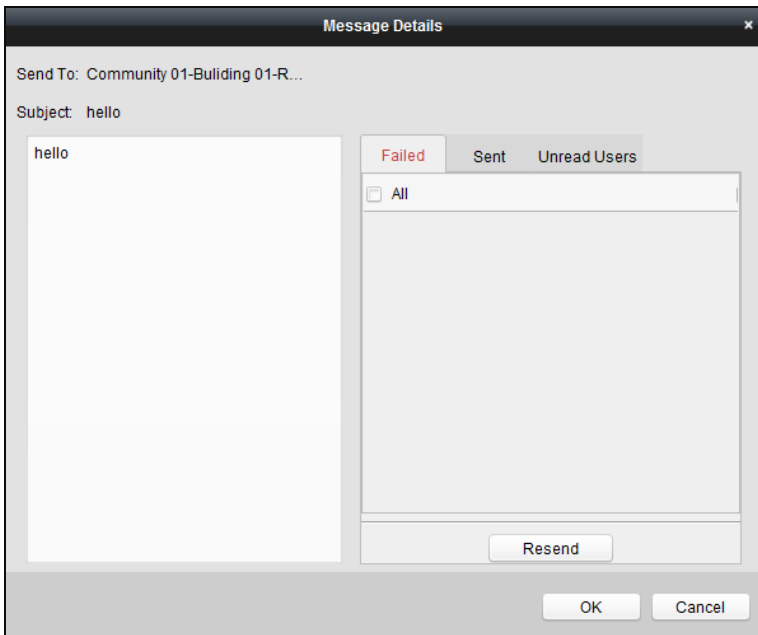

- 4. You can view and edit the notice details, check the sending failed/sent succeeded/unread users, and resend the notice to sending failed/unread users.
- 5. (Optional) Click **Export** to export the notices to your PC.

Appendix

Installation Notice

While installing the indoor station, make sure that the distance between any two devices is far enough to avoid the howling and echo. The distance between two devices is recommended to be longer than 10 meters.



NOTE

Here devices refer to indoor station, outdoor station and master station.

Wiring Cables

Cable	Specification
Power Cord of Door Station	RVV 2*1.0
Network Cable of Door Station	UTP-five Categories
Door Lock Wiring (With Door Magnetic)	RVV 4*1.0
Door Lock Wiring (Without Door Magnetic)	RVV 2*1.0
Exit Button Wiring	RVV 2*0.5
External Card Reader Wiring	RVVP 4*0.75

