



Explosion-Proof Bullet Network Camera

Quick Start Guide

UD14888B-A



Quick Start Guide

©2019 Hangzhou Hikvision Digital Technology Co., Ltd. All rights reserved.

This Manual is the property of Hangzhou Hikvision Digital Technology Co., Ltd. or its affiliates (hereinafter referred to as “Hikvision”), and it cannot be reproduced, changed, translated, or distributed, partially or wholly, by any means, without the prior written permission of Hikvision. Unless otherwise expressly stated herein, Hikvision does not make any warranties, guarantees or representations, express or implied, regarding to the Manual, any information contained herein.

About this Manual

The Manual includes instructions for using and managing the Product. Pictures, charts, images and all other information hereinafter are for description and explanation only. The information contained in the Manual is subject to change, without notice, due to firmware updates or other reasons. Please find the latest version of this Manual at the Hikvision website (<http://overseas.hikvision.com/en/>).

Please use this Manual with the guidance and assistance of professionals trained in supporting the Product.

Trademarks Acknowledgement

- **HIKVISION** and other Hikvision’s trademarks and logos are the properties of Hikvision in various jurisdictions.



- Other trademarks and logos mentioned are the properties of their respective owners.

LEGAL DISCLAIMER

- TO THE MAXIMUM EXTENT PERMITTED BY APPLICABLE LAW, THIS MANUAL AND THE PRODUCT DESCRIBED, WITH ITS HARDWARE, SOFTWARE AND FIRMWARE, ARE PROVIDED “AS IS” AND “WITH ALL FAULTS AND ERRORS”. HIKVISION MAKES NO WARRANTIES, EXPRESS OR IMPLIED, INCLUDING WITHOUT LIMITATION, MERCHANTABILITY, SATISFACTORY QUALITY, OR FITNESS FOR A PARTICULAR PURPOSE. THE USE OF THE PRODUCT BY YOU IS AT YOUR OWN RISK. IN NO EVENT WILL HIKVISION BE LIABLE TO YOU FOR ANY SPECIAL, CONSEQUENTIAL, INCIDENTAL, OR INDIRECT DAMAGES, INCLUDING, AMONG OTHERS, DAMAGES FOR LOSS OF BUSINESS PROFITS, BUSINESS INTERRUPTION, OR LOSS OF DATA, CORRUPTION OF SYSTEMS, OR LOSS OF DOCUMENTATION, WHETHER BASED ON BREACH OF CONTRACT, TORT (INCLUDING NEGLIGENCE), PRODUCT LIABILITY, OR OTHERWISE, IN CONNECTION WITH THE USE OF THE PRODUCT, EVEN IF HIKVISION HAS BEEN ADVISED OF THE POSSIBILITY OF SUCH DAMAGES OR LOSS.
- YOU ACKNOWLEDGE THAT THE NATURE OF INTERNET PROVIDES FOR INHERENT SECURITY RISKS, AND HIKVISION SHALL NOT TAKE ANY RESPONSIBILITIES FOR ABNORMAL OPERATION, PRIVACY LEAKAGE OR OTHER DAMAGES RESULTING FROM CYBER-ATTACK, HACKER ATTACK, VIRUS INSPECTION, OR OTHER INTERNET SECURITY RISKS; HOWEVER,



HIKVISION WILL PROVIDE TIMELY TECHNICAL SUPPORT IF REQUIRED.

- YOU AGREE TO USE THIS PRODUCT IN COMPLIANCE WITH ALL APPLICABLE LAWS, AND YOU ARE SOLELY RESPONSIBLE FOR ENSURING THAT YOUR USE CONFORMS TO THE APPLICABLE LAW. ESPECIALLY, YOU ARE RESPONSIBLE, FOR USING THIS PRODUCT IN A MANNER THAT DOES NOT INFRINGE ON THE RIGHTS OF THIRD PARTIES, INCLUDING WITHOUT LIMITATION, RIGHTS OF PUBLICITY, INTELLECTUAL PROPERTY RIGHTS, OR DATA PROTECTION AND OTHER PRIVACY RIGHTS. YOU SHALL NOT USE THIS PRODUCT FOR ANY PROHIBITED END-USES, INCLUDING THE DEVELOPMENT OR PRODUCTION OF WEAPONS OF MASS DESTRUCTION, THE DEVELOPMENT OR PRODUCTION OF CHEMICAL OR BIOLOGICAL WEAPONS, ANY ACTIVITIES IN THE CONTEXT RELATED TO ANY NUCLEAR EXPLOSIVE OR UNSAFE NUCLEAR FUEL-CYCLE, OR IN SUPPORT OF HUMAN RIGHTS ABUSES.
- IN THE EVENT OF ANY CONFLICTS BETWEEN THIS MANUAL AND THE APPLICABLE LAW, THE LATER PREVAILS.

Regulatory Information

FCC Information

Please take attention that changes or modification not expressly approved by the party responsible for compliance could void the user's authority to operate the equipment.

FCC compliance: This equipment has been tested and found to comply with the limits for a Class A digital device, pursuant to part



15 of the FCC Rules. These limits are designed to provide reasonable protection against harmful interference when the equipment is operated in a commercial environment. This equipment generates, uses, and can radiate radio frequency energy and, if not installed and used in accordance with the instruction manual, may cause harmful interference to radio communications. Operation of this equipment in a residential area is likely to cause harmful interference in which case the user will be required to correct the interference at his own expense.

FCC Conditions

This device complies with part 15 of the FCC Rules. Operation is subject to the following two conditions:

1. This device may not cause harmful interference.
2. This device must accept any interference received, including interference that may cause undesired operation.

EU Conformity Statement



This product and - if applicable - the supplied accessories too are marked with "CE" and comply therefore with the applicable harmonized

European standards listed under the EMC Directive 2014/30/EU, the RoHS Directive 2011/65/EU, the ATEX Directive 2014/34/EU.



2012/19/EU (WEEE directive): Products marked with this symbol cannot be disposed of as unsorted municipal waste in the European Union. For proper recycling, return this product to your local supplier



upon the purchase of equivalent new equipment, or dispose of it at designated collection points. For more information see:

www.recyclethis.info



2006/66/EC (battery directive): This product contains a battery that cannot be disposed of as unsorted municipal waste in the European Union. See the product documentation for specific battery information. The battery is marked with this symbol,

which may include lettering to indicate cadmium (Cd), lead (Pb), or mercury (Hg). For proper recycling, return the battery to your supplier or to a designated collection point. For more information see: www.recyclethis.info

Intended use of the camera

ATEX:  II 2 G D Ex db IIC T6 Gb/Ex tb IIIC T80°C Db IP68

IECEX: Ex db IIC T6 Gb/Ex tb IIIC T80°C Db IP68

Hazardous Area Classification: Zone 1, Zone 2, Zone 21, Zone 22.

IP Degree: IP68 (2m, 2h)

Ex Standards:

IEC 60079-0: 2011 EN 60079-0: 2012/All: 2013

IEC 60079-1: 2014 EN 60079-1: 2014

IEC 60079-31: 2013 EN 60079-31: 2014

Nameplate:



Explosion-Proof Fixed Dome 1	
Product Model: DS-2XE61XXXX-XX	TÜV 17 ATEX 8089 X
Protection Level: IP68(2m/2h) Temperature:-40°C~ +60°C	II 2 G Ex db IIC T6 Gb
Working Voltage:DC9~16V Working Current: ≤1000mA	II 2 D Ex tb IIIC T80°C Db
Product No.: xxxxxxxxxxxx Date of Production: xxxxxx	IECEX TUR 17.0041X
Hikvision Digital Technology Co., Ltd	Ex db IIC T6 Gb
555 Qianmo Road, Binjiang District, Hangzhou , China	Ex tb IIIC T80°C Db

Special Conditions for Safe Use:

1. Ambient Temperature: -40°C to +60°C.
2. DO NOT OPEN WHEN ENERGIZED.
3. When assembly, operation and maintenance, the operator must follow the requirements of the IEC 60079-14: latest version Explosive atmosphere- Part 14: Electrical installation design, selection and erection, beside of the manufacturer's operation instruction or its National equivalent.
4. Repair and overhaul shall comply with IEC 60079-19: latest version or its National equivalent.

Industry Canada ICES-003 Compliance

This device meets the CAN ICES-3 (A)/NMB-3(A) standards requirements.

Warning:

This is a class A product. In a domestic environment this product may cause radio interference in which case the user may be required to take adequate measures.

Safety Instruction





These instructions are intended to ensure that user can use the product correctly to avoid danger or property loss.

The precaution measure is divided into “Warnings” and “Cautions”

Warnings: Serious injury or death may occur if any of the warnings are neglected.

Cautions: Injury or equipment damage may occur if any of the cautions are neglected.

	
Warnings Follow these safeguards to prevent serious injury or death.	Cautions Follow these precautions to prevent potential injury or material damage.



Warnings

- For device with this sticker, this device is intended for installation in a restricted access location, access can only be gained by service persons or by users who have been instructed about the reasons for the restrictions applied to the location and about any precautions that shall be taken.
- Proper configuration of all passwords and other security settings is the responsibility of the installer and/or end-user.





- Do not stare at the operating light source. May be harmful to the eyes. Wear appropriate eye protection or do not turn on the supplement light when you assemble, install or maintain the camera.

- The both internal and external earthing shall be connected reliably.

Ground wire cross-sectional area of not less than the phase connector cross-sectional area level, at least 4 mm².

- All the electrical operation should be strictly compliance with the electrical safety regulations, fire prevention regulations and other related regulations of the nation and region.
- Make sure that the power has been disconnected before you wire, install or disassemble the camera. Never wire, install or disassemble the camera in explosive environment.
- Do not connect several devices to one power adapter as adapter overload may cause over-heating or a fire hazard.
- To avoid fire danger caused by electrostatic charge, never touch or wipe the camera in explosive environment. Perform the wiping and replacing accessories only under non-explosive environment with the provided glove.
- When the camera is installed on wall or ceiling, the device shall be firmly fixed.
- If smoke, odors or noise rise from the camera, turn off the power at once and unplug the power cable, and then contact the service center.
- If the camera does not work properly, contact your dealer or the nearest service center. Never attempt to disassemble the



speed dome yourself. (We shall not assume any responsibility for problems caused by unauthorized repair or maintenance.)



Cautions

- Make sure the power supply voltage is correct before using the camera.
- Do not drop the camera or subject it to physical shock.
- To ensure explosion-proof performance, do not damage explosion-proof surface.
- Do not touch sensor modules with fingers. If cleaning is necessary, use clean cloth with a bit of ethanol and wipe it gently. If the camera will not be used for an extended period, please replace the lens cap to protect the sensor from dirt.
- Do not aim the camera at the sun or extra bright places. Blooming or smearing may occur otherwise (which is not a malfunction), and affect the endurance of sensor at the same time.
- The sensor may be burned out by a laser beam, so when any laser equipment is in using, make sure that the surface of sensor will not be exposed to the laser beam.
- Do not place the camera in extremely hot, cold (the operating temperature shall be -40°C to +60°C), dusty or damp locations, and do not expose it to high electromagnetic radiation.
- To avoid heat accumulation, good ventilation is required for operating environment.



- Keep the camera away from liquid while in use.
- While in delivery, the camera shall be packed in its original packing, or packing of the same texture.
- Regular part replacement: a few parts (e.g. electrolytic capacitor) of the equipment shall be replaced regularly according to their average enduring time. The average time varies because of differences between operating environment and using history, so regular checking is recommended for all the users. Please contact with your dealer for more details.
- Improper use or replacement of the battery may result in hazard of explosion. Replace with the same or equivalent type only. Dispose of used batteries according to the instructions provided by the battery manufacturer. L'utilisation ou le remplacement inadéquats de la pile peuvent entraîner un risque d'explosion. Remplacez-la par le même type ou l'équivalent du même type seulement. Jetez les piles usagées conformément aux directives fournies par le fabricant de la pile.
- If the product does not work properly, please contact your dealer or the nearest service center. Never attempt to disassemble the camera yourself. (We shall not assume any responsibility for problems caused by unauthorized repair or maintenance.)



Table of Contents

1 Introduction	12
1.1 Overview.....	12
1.2 Model Description.....	12
2 Appearance	14
2.1 Overview.....	14
2.2 Cable Description.....	15
3 Installation	17
3.1 Wall Mounting.....	18
3.2 Cable Connection.....	21
4 Setting the Network Camera over the LAN	24
4.1 Wiring.....	24
4.2 Activating the Camera.....	25
4.2.1 Activation via Web Browser.....	25
4.2.2 Activation via SADP Software.....	26
4.3 Modifying the IP Address.....	28
5 Accessing via Web Browser	31
6 Operating via Hik-Connect App	33
6.1 Enable Hik-Connect Service on Camera.....	33
6.1.1 Enable Hik-Connect Service via SADP Software ..	33
6.1.2 Enable Hik-Connect Service via Web Browser	34
6.2 Hik-Connect Setup.....	36
6.3 Adding Camera to Hik-Connect.....	36
6.4 Initializing the Memory Card.....	38



1 Introduction

1.1 Overview

Explosion-proof network camera is a video security product capable of smart encoding and network transmitting. It adopts an embedded system and a high-performed hardware process platform to achieve good stability and reliability.

You can visit and configure your camera via web browser and client software.

Explosion-proof network camera adopts a stainless steel enclosure, receiving an IP68 rating for ingress protection.

Application Scenarios: oil industry, mine fields, chemical industry, port, grain processing industry, etc.

1.2 Model Description

This manual is applicable to the following models:

Table 1-1 Applicable Model List

Model List		
DS-2XE6825G0-IZHS	DS-2XE6845G0-LZHS	DS-2XE6885G0-IZ
DS-2XE6845G0-IZHS	DS-2XE6885G0-LZHS	DS-2XE6825G0-LZ
DS-2XE6885G0-IZHS	DS-2XE6825G0-IZ	DS-2XE6845G0-LZ
DS-2XE6825G0-LZHS	DS-2XE6845G0-IZ	DS-2XE6885G0-LZ

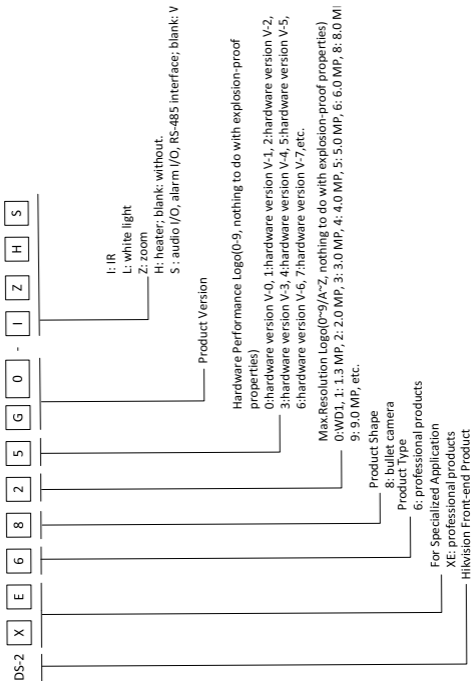

Figure 1-1 Model Explanation



2 Appearance

2.1 Overview

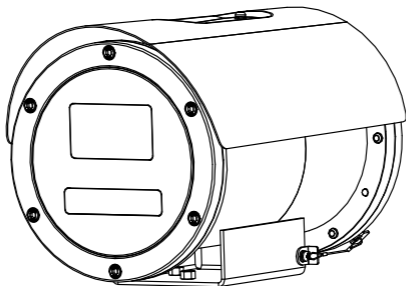

Figure 2-1 Overview



2.2 Cable Description

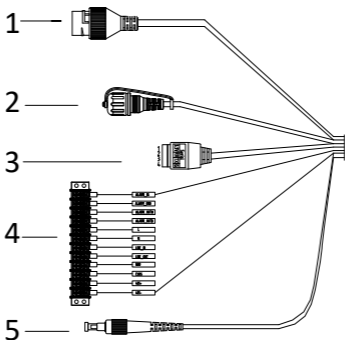

Figure 2-2 Overview of Cables

Table 2-1 Description of Cables

No.	Description	No.	Description
1	Network Interface	4	Alarm*/Power/Audio*/Grounding/CV BS/RS-485 Interface
2	Reset Interface	5	Fiber Optical Interface



3	Serial Port		
---	-------------	--	--



3 Installation

Before you start:

- Suitable certified flameproof 'd' and dust ignition protection 't' cable glands, correctly installed and suitable for the conditions of use.
- Make sure the device in the package is in good condition and all the assembly parts are included.
- The standard power supply is 100 to 240 VAC, please make sure your power supply matches with your camera.
- Make sure all the related equipment is power-off during the installation.
- Check the specification of the products for the installation environment.
- Make sure that the wall is strong enough to withstand four times the weight of the camera and the bracket.

For the camera that supports IR, you are required to pay attention to the following precautions to prevent IR reflection:

- Dust or grease on the dome cover will cause IR reflection. Please do not remove the dome cover film until the installation is finished. If there is dust or grease on the dome cover, clean the dome cover with clean soft cloth and isopropyl alcohol.
- Make sure that there is no reflective surface too close to the camera lens. The IR light from the camera may reflect back into the lens causing reflection.



- The foam ring around the lens must be seated flush against the inner surface of the bubble to isolate the lens from the IR LEDs. Fasten the dome cover to camera body so that the foam ring and the dome cover are attached seamlessly.

3.1 Wall Mounting

Before you start:

Loosen the screws on the side of the PT joint to uninstall it.

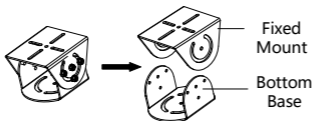

Figure 3-1 PT Joint

Steps:

1. Install the fixed mount of the PT joint to the camera with screws.

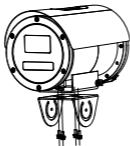

Figure 3-2 Install Fixed Mount to the Camera

2. Install the bottom base of the PT joint to the wall mounting bracket with the screws.

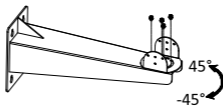

Figure 3-3 Install Bottom Base to the Bracket

3. Drill holes on the mounting plate and install the bracket to the mounting plate with the screws.

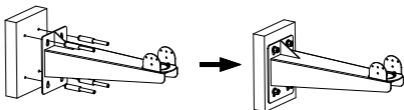

Figure 3-4 Install the Bracket

4. Hook the safety rope to the camera and the bracket.

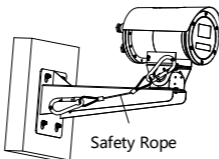

Figure 3-5 Hook the Safety Rope

5. Install the camera to the bracket with the screws.

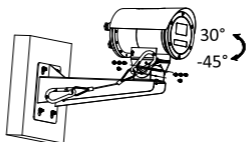

Figure 3-6 Install the Camera



3.2 Cable Connection

Steps:

1. Loosen the screws to remove the back cover.

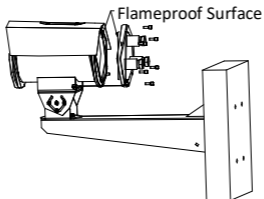

Figure 3-7 Remove the Back Cover

Note:

Do not unhook the safety rope from the camera when removing the back cover. Be careful with the flameproof surface in case it is damaged.

2. Loosen the gland nut to take out the gasket and sealing ring.

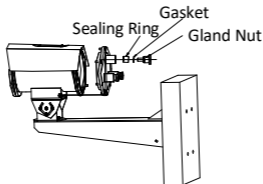

Figure 3-8 Loosen the Gland Nut



- Loosen the thread cap of the adapter. Thread the cable through the adapter, sealing ring and the conduit.

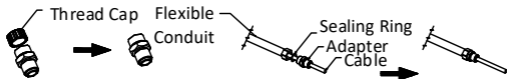

Figure 3-9 Thread the Cable through the Conduit

- Secure the adapter to the back cover with the wrench.

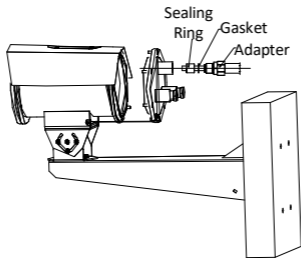

Figure 3-10 Secure Adapter to the Back Cover

- Connect the cables to the corresponding terminal blocks and fasten the gland nut.
- Install the back cover to the camera with the screws.

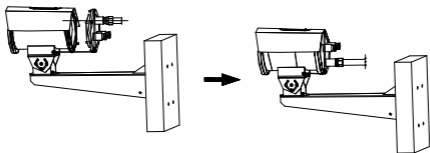

Figure 3-11 Install the Back Cover

7. Route the camera cables according to the figure below.

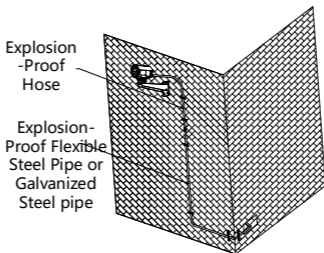

Figure 3-12 Route Cables

Note:

The cables connected to the control room should be protected by explosion-proof flexible steel pipe or galvanized steel pipe.



4 Setting the Network Camera over the LAN

Note:

You shall acknowledge that the use of the product with Internet access might be under network security risks. For avoidance of any network attacks and information leakage, please strengthen your own protection.

If the product does not work properly, contact your dealer or the nearest service center for help.

4.1 Wiring

Connect the camera to network according to the following figures.

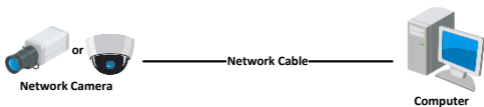

Figure 4-1 Connecting Directly

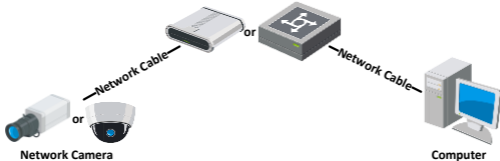

Figure 4-2 Connecting via a Switch or a Router



4.2 Activating the Camera

You are required to activate the camera first by setting a strong password for it before you can use the camera.

Activation via Web Browser, Activation via SADP, and Activation via Client Software are all supported. We will take activation via SADP software and Activation via Web Browser as examples to introduce the camera activation.

Note:

Refer to the User Manual of Network Camera for Activation via Client Software.

4.2.1 Activation via Web Browser

Steps:

1. Power on the camera. Connect the camera to your computer or the switch/router which your computer connects to.
2. Input the IP address into the address bar of the web browser, and press Enter to enter the activation interface.

Notes:

- The default IP address of the camera is 192.168.1.64.
- The computer and the camera should belong to the same subnet.
- For the camera enables the DHCP by default, you need to use the SADP software to search the IP address.

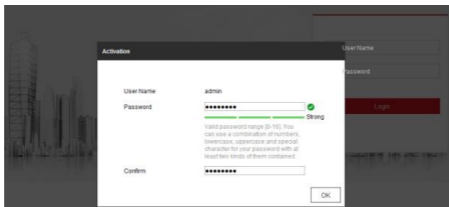

Figure 4-3 Activation Interface (Web)

3. Create a password and input the password into the password field.



STRONG PASSWORD RECOMMENDED— *We highly recommend you create a strong password of your own choosing (using a minimum of 8 characters, including upper case letters, lower case letters, numbers, and special characters) in order to increase the security of your product. And we recommend you reset your password regularly, especially in the high security system, resetting the password monthly or weekly can better protect your product.*

4. Confirm the password.
5. Click **OK** to save the password and enter the live view interface.

4.2.2 Activation via SADP Software

SADP software is used for detecting the online device, activating the camera, and resetting the password.

Get the SADP software from the supplied disk or the official website, and install the SADP according to the prompts.



Follow the steps to activate the camera.

Steps:

1. Run the SADP software to search the online devices.
2. Check the device status from the device list, and select the inactive device.

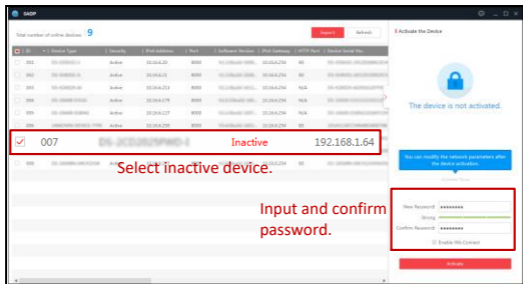

Figure 4-4 SADP Interface

Note:

The SADP software supports activating the camera in batch. Refer to the user manual of SADP software for details.

3. Create and input the new password in the password field, and confirm the password.



STRONG PASSWORD RECOMMENDED– *We highly recommend you create a strong password of your own choosing (using a minimum of 8 characters, including upper case letters, lower case letters, numbers, and special characters) in order to increase the security of your product. And we recommend you reset your password regularly, especially in the high security system, resetting the password monthly or weekly can better protect your product.*

Note:

You can enable the Hik-Connect service for the device during activation. Refer to Chapter 6.1 for detailed information.

4. Click **Activate** to start activation.

You can check whether the activation is completed on the popup window. If activation failed, make sure that the password meets the requirement and try again.

4.3 Modifying the IP Address

Purpose:

To view and configure the camera via LAN (Local Area Network), you need to connect the network camera in the same subnet with your PC.

Use the SADP software or client software to search and change the IP address of the device. We take modifying the IP Address via SADP software as an example to introduce the IP address modification.

For IP address modification via client software, refer to the user manual of client software.



Steps:

1. Run the SADP software.
2. Select an active device.
3. Change the device IP address to the same subnet with your computer by either modifying the IP address manually or checking the checkbox of **Enable DHCP**.

Modify Network Parameters

Enable DHCP
 Enable Hik-Connect

Device Serial No.:

IP Address:

Port:

Subnet Mask:

Gateway:

IPv6 Address:

IPv6 Gateway:

IPv6 Prefix Length:

HTTP Port:

Security Verification

Admin Password:

[Modify](#)

[Forgot Password](#)

Figure 4-5 Modify the IP Address



Note:

You can enable the Hik-Connect service for the device during activation. Refer to Chapter 6.1 for detailed information.

4. Input the admin password and click **Modify** to activate your IP address modification.

The batch IP address modification is supported by the SADP. Refer to the user manual of SADP for details.



5 Accessing via Web Browser

System Requirement:

Operating System: Microsoft Windows XP SP1 and above version

CPU: 2.0 GHz or higher

RAM: 1G or higher

Display: 1024×768 resolution or higher

Web Browser: Internet Explorer 8.0 and above version, Apple Safari 5.0.2 and above version, Mozilla Firefox 5.0 and above version and Google Chrome 18 and above version

Steps:

1. Open the web browser.
2. In the browser address bar, input the IP address of the network camera, and press the **Enter** key to enter the login interface.

Note:

- The default IP address is 192.168.1.64. You are recommended to change the IP address to the same subnet with your computer.

3. Input the user name and password.

The admin user should configure the device accounts and user/operator permissions properly. Delete the unnecessary accounts and user/operator permissions.

Note:

The device IP address gets locked if the admin user performs 7 failed password attempts (5 attempts for the user/operator).



4. Click **Login**.



Figure 5-1 Login Interface

5. Install the plug-in before viewing the live video and managing the camera. Follow the installation prompts to install the plug-in.

Note:

You may have to close the web browser to finish the installation of the plug-in.

[Please click here to download and install the plug-in. Close the browser when installing the plug-in.](#)

Figure 5-2 Download Plug-in

6. Reopen the web browser after the installation of the plug-in and repeat steps 2 to 4 to login.

Note:

For detailed instructions of further configuration, please refer to the user manual of network camera.



6 Operating via Hik-Connect App

Purpose:

Hik-Connect is an application for mobile devices. With the App, you can view live image of the camera, receive alarm notification and so on.

Note:

Hik-Connect service is not supported by certain camera models.

6.1 Enable Hik-Connect Service on Camera

Purpose:

Hik-Connect service should be enabled on your camera before using the service.

You can enable the service through SADP software or web browser.

6.1.1 Enable Hik-Connect Service via SADP Software

Steps:

1. Check the checkbox of **Enable Hik-Connect** on:
 - 1). "Activate the Device" page during camera activation, refer to Chapter 4.2.2.
 - 2). Or "Modify Network Parameters" page during modifying IP address, refer to Chapter 4.3.
2. Create a verification code or change the verification code.



The screenshot shows a 'Tips' dialog box with a red title bar. The main text reads: 'To enable Hik-Connect service, you need to create a verification code or change the verification code.' Below this, there are two input fields. The first is labeled 'Verification Code' and contains six dots. To its right, text specifies: '6 to 12 letters or numbers, case sensitive. You are recommended to use a combination of no less than 8 letters or numbers.' The second field is labeled 'Confirm Verification Code' and contains six dots with a cursor at the end. At the bottom, there is a note: 'The Hik-Connect service will require internet access. Please read the ["Terms of Service"](#) and ["Privacy Policy"](#) before enabling the service.' At the bottom right, there are two buttons: 'Confirm' (red) and 'Cancel' (white).

Figure 6-1 Verification Code Setting (SADP)

Note:

The verification code is required when you add the camera to Hik-Connect app.

3. Click and read "Terms of Service" and "Privacy Policy".
4. Confirm the settings.

6.1.2 Enable Hik-Connect Service via Web Browser

Before you start:

You need to activate the camera before enabling the service. Refer to Chapter 4.2.



Steps:

1. Access the camera via web browser. Refer to Chapter 5.
2. Enter platform access configuration interface: **Configuration > Network > Advanced Settings > Platform Access.**

Enable

Platform Access Mode

Server IP Custom

Register Status

Verification Code

6 to 12 letters (a to z, A to Z) or numbers (0 to 9), case sensitive. You are recommended to use

Figure 6-2 Platform Access Configuration (Web)

3. Select **Platform Access Mode** as **Hik-Connect**.
4. Check the checkbox of **Enable**.
5. Click and read "Terms of Service" and "Privacy Policy" in pop-up window.
6. Create a verification code or change the verification code for the camera.

Note:

The verification code is required when you add the camera to Hik-Connect app.

7. Save the settings.



6.2 Hik-Connect Setup

Steps:

1. Download and install the Hik-Connect app by searching “Hik-Connect” in App Store or Google Play™.
2. Launch the app and register for a Hik-Connect user account.
3. Log in Hik-Connect app after registration.

6.3 Adding Camera to Hik-Connect

Before you start:

You need to enable the Hik-Connect service on camera before adding it to your Hik-Connect account. Refer to Chapter 6.1.

Steps:

1. Use a network cable to connect the camera with a router if the camera does not support Wi-Fi.



Figure 6-3 Connect a Router

Note:

After the camera connects to the network, please wait one minute before any operation on the camera using Hik-Connect app.

2. In the Hik-Connect app, tap “+” on the upper-right corner and then scan the QR code of the camera to add the camera.



You can find the QR code on the camera or on the cover of the Quick Start Guide of the camera in the package.

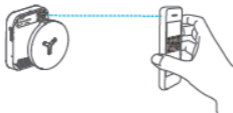



Figure 6-4 Scan QR Code

Note:

If the QR code is missing or too blur to be recognized, you can also add the camera by tapping the  icon and inputting the camera's serial number.

3. Input the verification code of your camera.

Note:

- The required verification code is the code you create or change when you enabling Hik-Connect service on camera.
- If you forget the verification code, you can check the current verification code on **Platform Access** configuration page via web browser.

4. Follow the prompts to set the network connection and add the camera to your Hik-Connect account.

Note:

For detailed information, refer to the user manual of the Hik-Connect app.



6.4 Initializing the Memory Card

Check the memory card status by tapping on the Storage Status in the Device Settings interface.

If the memory card status displays as Uninitialized, tap to initialize it. The status will then change to Normal. You can then start recording any event triggered video in the camera such as motion detection.

