

## DS-2DF8C425MHS-DEL 4 MP 25 × Network Speed Dome

DarkFighterX

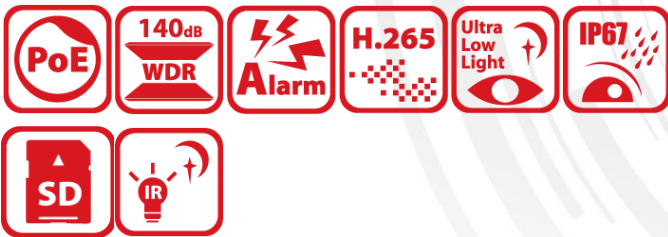

Hikvision DS-2DF8C425MHS-DEL(T5) 4MP 25 × Network Speed Dome adopts 1/1.8" progressive scan CMOS chip. With the 25 × optical zoom lens, the camera offers more details over expansive areas. This series of cameras can be widely used for wide ranges of high-definition, such as the rivers, forests, roads, railways, airports, ports, squares, parks, scenic spots, stations and large venues, etc.

- Dual sensor 1/1.8" progressive scan CMOS
- High quality imaging with 4 MP resolution
- Excellent low-light performance with DarkFighterX technology
- 25 × optical zoom and 16 × digital zoom provide close up views over expansive areas
- 300 m IR distance
- Water and dust resistant (IP67)
- Supports face capture to detect, capture, grade, and select faces in motion
- Efficient H.265+/H.265 compression technology
- 140 dB WDR, 3D DNR, HLC, BLC, EIS, defog
- Supports road traffic to detect vehicles



## ▪ DORI

The DORI (detect, observe, recognize, identify) distance gives the general idea of the camera ability to distinguish persons or objects within its field of view.

It is calculated based on the camera sensor specification and the criteria given by EN 62676-4: 2015.

DORI	Detect	Observe	Recognize	Identify
Definition	25 px/m	63 px/m	125 px/m	250 px/m
Distance (Tele)	2034.5 m (6674.9 ft.)	807.3 m (2648.6 ft.)	406.9 m (1335 ft.)	203.5 m (667.3 ft.)

## ▪ Specification

Camera	
Image Sensor	Two sensors, 1/1.8" Progressive Scan CMOS
Max. Resolution	2560 × 1440
Min. Illumination	Color: 0.0004 Lux @ (F1.6, AGC ON), B/W: 0.0001 Lux @ (F1.6, AGC ON), 0 Lux with IR
Shutter Speed	1/1 s to 1/30000 s
Zoom	25 × optical, 16 × digital
Slow Shutter	Yes
Lens	
Focal Length	5.9 to 147.5 mm
FOV	Horizontal field of view: 59° to 3.05°, vertical field of view: 34.28° to 1.73°, diagonal field of view: 66.92° to 3.49°
Focus	Auto, semi-auto, manual, rapid focus
Aperture	F1.6
Zoom Speed	Approx. 6.2 s
Illuminator	
Supplement Light Type	Hybrid
Supplement Light Range	IR distance: up to 300 m
Smart Supplement Light	Yes
PTZ	
Movement Range (Pan)	0° to 360°
Movement Range (Tilt)	-20° to 90°
Pan Speed	Pan speed: configurable from 0.1° to 210°/s, preset speed: 280°/s
Tilt Speed	Tilt speed: configurable from 0.1° to 150°/s, preset speed 250°/s
Proportional Pan	Yes
Presets	300
Preset Freezing	Yes
Patrol Scan	8 patrols, up to 32 presets for each patrol
Pattern Scan	4 pattern scans, record time over 10 minutes for each scan
Park Action	Preset, pattern scan, patrol scan, auto scan, tilt scan, random scan, frame scan, panorama scan
3D Positioning	Yes
PTZ Status Display	Yes
Scheduled Task	Preset, pattern scan, patrol scan, auto scan, tilt scan, random scan, frame scan, panorama scan, dome reboot, dome adjust, aux output
Power-off Memory	Yes

<b>Video</b>	
Main Stream	50 Hz: 25 fps (2560 × 1440, 1920 × 1080, 1280 × 960, 1280 × 720) 60 Hz: 30 fps (2560 × 1440, 1920 × 1080, 1280 × 960, 1280 × 720)
Sub-Stream	50 Hz: 25 fps (704 × 576, 640 × 480, 352 × 288) 60 Hz: 30 fps (704 × 480, 640 × 480, 352 × 240)
Third Stream	50 Hz: 25 fps (1920 × 1080, 1280 × 960, 1280 × 720, 704 × 576, 640 × 480, 352 × 288) 60 Hz: 30 fps (1920 × 1080, 1280 × 960, 1280 × 720, 704 × 480, 640 × 480, 352 × 240)
Video Compression	Main stream: H.265+/H.265/H.264+/H.264, Sub-stream: H.265/H.264/MJPEG, Third stream: H.265/H.264/MJPEG
Video Bit Rate	32 Kbps to 16 Mbps
H.264 Type	Baseline profile, Main profile, High profile
H.265 Type	Main profile
Scalable Video Coding (SVC)	H.264 and H.265 encoding
Region of Interest (ROI)	8 fixed regions for each stream
<b>Audio</b>	
Audio Compression	G.711, G.722.1, G.726, MP2L2, PCM, AAC-LC
Audio Bit Rate	64 Kbps (G.711), 16 Kbps (G.722.1), 16 Kbps (G.726), 32 to 192 Kbps (MP2L2), 16 to 64Kbps (AAC-LC)
<b>Network</b>	
Protocols	IPv4/IPv6, HTTP, HTTPS, 802.1X, QoS, FTP, TCP/IP, ICMP, DHCP, DNS, DDNS, RTP, RTSP, RTCP, PPPoE, UPnP, SMTP, SNMP, IGMP, UDP, Bonjour, NTP
Simultaneous Live View	Up to 20 channels
API	Open Network Video Interface (Profile S, Profile G, Profile T), ISAPI, SDK, ISUP
User/Host	Up to 32 users. 3 user levels: administrator, operator, and user
Security	Password protection, complicated password, IP address filter, HTTPS encryption, 802.1X authentication (EAP-TLS, EAP-LEAP, EAP-MD5), host authentication (MAC address), watermark
Network Storage	NAS (NFS, SMB/CIFS), auto network replenishment (ANR)
Client	iVMS-4200, HikCentral Pro, Hik-Connect
Web Browser	IE 10+, Chrome 57+, Firefox 52+, Safari 12+
<b>Image</b>	
Image Parameters Switch	Yes
Image Settings	Saturation, brightness, contrast, sharpness, gain, and white balance adjustable by client software or web browser
Day/Night Switch	Day, night, auto, schedule
Wide Dynamic Range (WDR)	140 dB
SNR	≥ 52 dB
Defog	Optical defog
Image Stabilization	EIS
Image Enhancement	BLC, HLC, 3D DNR
Privacy Mask	24 programmable polygon privacy masks, mask color or mosaic configurable
Regional Focus	Yes
Regional Exposure	Yes

<b>Interface</b>	
Video Output	CVBS: 1.0 V[p-p]/75 Ω, PAL/NTSC, BNC connector
Ethernet Interface	1 RJ45 10M/100M self-adaptive Ethernet port
On-board Storage	Built-in memory card slot, support microSD/microSDHC/microSDXC card, up to 256 GB
Audio	1 input (line in), max. input amplitude: 2-2.4 vpp, input impedance: 1 KΩ ± 10%, 1 output (line out), line level, output impedance: 600 Ω
Alarm	7 input(s), 2 output(s)
RS-485	1 RS-485 (Half duplex, HIKVISION, Pelco-P, Pelco-D, self-adaptive)
Reset	Yes
<b>Event</b>	
Basic Event	Motion detection, video tampering alarm, exception, alarm input and output
Smart Event	Line crossing detection, intrusion detection, region entrance detection, region exiting detection, audio exception detection, unattended baggage detection, object removal detection
Alarm Linkage	Upload to FTP/NAS/memory card, notify surveillance center, send email, trigger alarm output, trigger recording, and PTZ actions (such as preset, patrol scan, pattern scan)
Smart Tracking	Manual tracking, auto-tracking
<b>Deep Learning Function</b>	
Face Capture	Supports detecting, tracking, capturing, grading, selecting of face in motion, and outputs the best face picture
Face Comparison	Recognizes face identity via face modeling, grading and comparing to those in face library
<b>Road Traffic and Vehicle Detection</b>	
Road Traffic	Support vehicle detection (license plate number, vehicle model, and vehicle color recognition)
<b>General</b>	
Power	36 VDC ± 25%, max. 62 W, Hi-PoE
Dimension	∅267 mm × 430 mm (∅10.5" × 16.9")
Weight	Approx. 10 kg (22.05 lb.)
Material	ADC12
Operating Condition	-40 °C to 70 °C (-40 °F to 158 °F). Humidity 95% or less (non-condensing)
Vandal-proof Alarm	Yes
Heater	Yes
Wiper	No
Demist	Yes
Language	33 languages: English, Russian, Estonian, Bulgarian, Hungarian, Greek, German, Italian, Czech, Slovak, French, Polish, Dutch, Portuguese, Spanish, Romanian, Danish, Swedish, Norwegian, Finnish, Croatian, Slovenian, Serbian, Turkish, Korean, Traditional Chinese, Thai, Vietnamese, Japanese, Latvian, Lithuanian, Portuguese (Brazil), Ukrainian
<b>Approval</b>	
EMC	FCC (47 CFR Part 15, Subpart B), CE-EMC (EN 55032: 2015, EN 61000-3-2: 2019, EN 61000-3-3: 2013 + A1: 2019, EN 50130-4: 2011 + A1: 2014), RCM (AS/NZS CISPR 32: 2015), IC (ICES-003: Issue 7), KC (KN 32: 2015, KN 35: 2015)

Safety	CE-LVD (EN 62368-1: 2014/A11: 2017), CB (IEC 62368-1: 2014 + A11), UL (UL 62368-1), BIS (IS 13252 (Part 1): 2010/IEC 60950-1: 2005), LOA (IEC/EN 60950-1)
Environment	CE-RoHS (2011/65/EU), WEEE (2012/19/EU), Reach (Regulation (EC) No 1907/2006)
Protection	IP67 (IEC 60529-2013), IK10 (IEC 62262:2002), TVS 6K V lightning protection, surge protection and voltage transient protection

### ▪ Available Model

DS-2DF8C425MHS-DEL

### ▪ Typical Application

Hikvision products are classified into three levels according to their anti-corrosion performance. Refer to the following description to choose for your using environment.

This model has NO SPECIFIC PROTECTION.





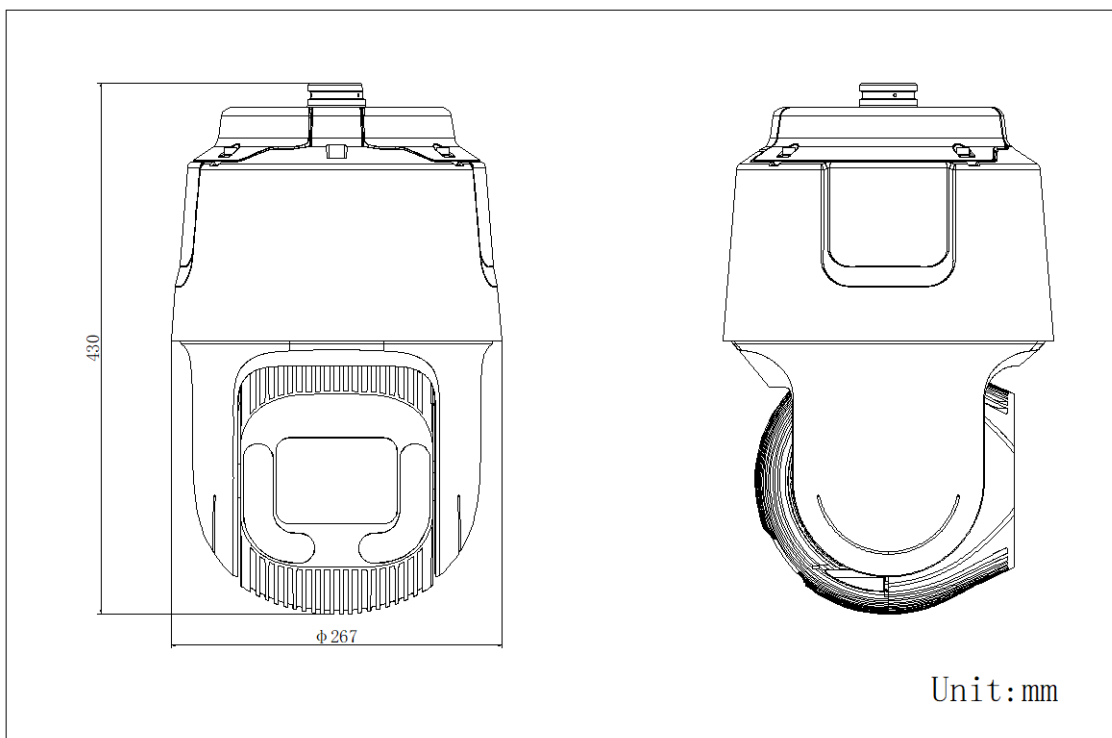

Level	Description
Top-level protection	Hikvision products at this level are equipped for use in areas where professional anti-corrosion protection is a must. Typical application scenarios include coastlines, docks, chemical plants, and more.
Moderate protection	Hikvision products at this level are equipped for use in areas with moderate anti-corrosion demands. Typical application scenarios include coastal areas about 2 kilometers (1.24 miles) away from coastlines, as well as areas affected by acid rain.
No specific protection	Hikvision products at this level are equipped for use in areas where no specific anti-corrosion protection is needed.

▪ **Dimension**



▪ **Accessory**

▪ **Optional**

DS-1603ZJ-Corner -P	DS-1668ZJ(20)-P	DS-1619ZJ-HP2	DS-1673ZJ-P	DS-1668ZJ-P
				
DS-1603ZJ-P	DS-1603ZJ-Pole-P			
				

Distributed by

**HIKVISION®****Headquarters**

No.555 Qianmo Road, Binjiang District,  
Hangzhou 310051, China  
T +86-571-8807-5998  
overseasbusiness@hikvision.com

**Hikvision USA**  
T +1-909-895-0400  
sales.usa@hikvision.com

**Hikvision Australia**  
T +61-2-8599-4233  
salesau@hikvision.com

**Hikvision India**  
T +91-22-28469900  
sales@pramahikvision.com

**Hikvision Canada**  
T +1-866-200-6690  
sales.canada@hikvision.com

**Hikvision Thailand**  
T +662-275-9949  
sales.thailand@hikvision.com

**Hikvision Europe**  
T +31-23-5542770  
sales.eu@hikvision.com

**Hikvision Italy**  
T +39-0438-6902  
info.it@hikvision.com

**Hikvision Brazil**  
T +55 11 3318-0050  
Latam.support@hikvision.com

**Hikvision Turkey**  
T +90 (216)521 7070- 7074  
sales.tr@hikvision.com

**Hikvision Malaysia**  
T +601-7652-2413  
sales.my@hikvision.com

**Hikvision UK & Ireland**  
T +01628-902140  
sales.uk@hikvision.com

**Hikvision South Africa**  
Tel: +27 (10) 0351172  
sale.africa@hikvision.com

**Hikvision France**  
T +33(0)1-85-330-450  
info.fr@hikvision.com

**Hikvision Kazakhstan**  
T +7-727-9730667  
nikia.panfilov@hikvision.ru

**Hikvision Vietnam**  
T +84-974270888  
sales.vt@hikvision.com

**Hikvision UAE**  
T +971-4-4432090  
salesme@hikvision.com

**Hikvision Singapore**  
T +65-6684-4718  
sg@hikvision.com

**Hikvision Spain**  
T +34-91-737-16-55  
info.es@hikvision.com

**Hikvision Tashkent**  
T +99-87-1238-9438  
uzb@hikvision.ru

**Hikvision Hong Kong**  
T +852-2151-1761  
info.hk@hikvision.com

**Hikvision Russia**  
T +7-495-669-67-99  
saleru@hikvision.com

**Hikvision Korea**  
T +82-(0)31-731-8817  
sales.korea@hikvision.com

**Hikvision Poland**  
T +48-22-460-01-50  
info.pl@hikvision.com

**Hikvision Indonesia**  
T +62-21-2933759  
Sales.Indonesia@hikvision.com

**Hikvision Colombia**  
sales.colombia@hikvision.com