

Title:	Connecting a microphone to HikVision Cameras				
Date:	05/30/2014	Version:	1.0	Pages	7
Product:	IP cameras with audio input				
Action Required:	Information only				

Not all HikVision IP cameras have Audio in/Audio out. Please refer to the specification sheet of the camera for Audio capabilities.

As a rule of thumb, **all INDOOR dome cameras** and **all BOX style cameras** have 1 audio in and 1 audio out 3.5mm audio jack.

Also, if the camera that has an optional **(S)** in the part number (*example: DS-2CD7283F-EIZ(S)*), then it has audio in and audio out leads. There are some other leads as well. Please refer to the table below for lead information:

Lead Color	Purpose
Blue	Alarm In
Green	Alarm Ground
Black	Alarm Out
White	Alarm Out Ground
Brown	Line Out Right
Purple	Line Out left
Red	Line Ground
Yellow	Right In/Mic +
Orange	Left in/Mic -
Grey	Mic Ground

There are 2 types of microphones: **Active** and **Passive**.

- Active Microphones have a built in pre-amp, and require power to operate.
- Passive Microphones do not have built in amplifiers, however sometimes can require power.

Active microphones (LOUROE for example):

Depending on the pre-amp the Microphone might require:

* 12VDC. In this case the microphone has to be powered with a 12V DC power supply.

These types of microphones are called **LINE LEVEL MICROPHONES**

* 1.8VDC - 4.5VDC. In this case the Microphone will be powered right from the IP camera itself.

These types of microphones are called **MIC LEVEL MICROPHONES**

Figure 1 shows the diagram of wiring a LOUROE LE070 **LINE LEVEL MICROPHONE**

Title:	Connecting a microphone to HikVision Cameras				
Date:	05/30/2014	Version:	1.0	Pages	7
Product:	IP cameras with audio input				
Action Required:	Information only				

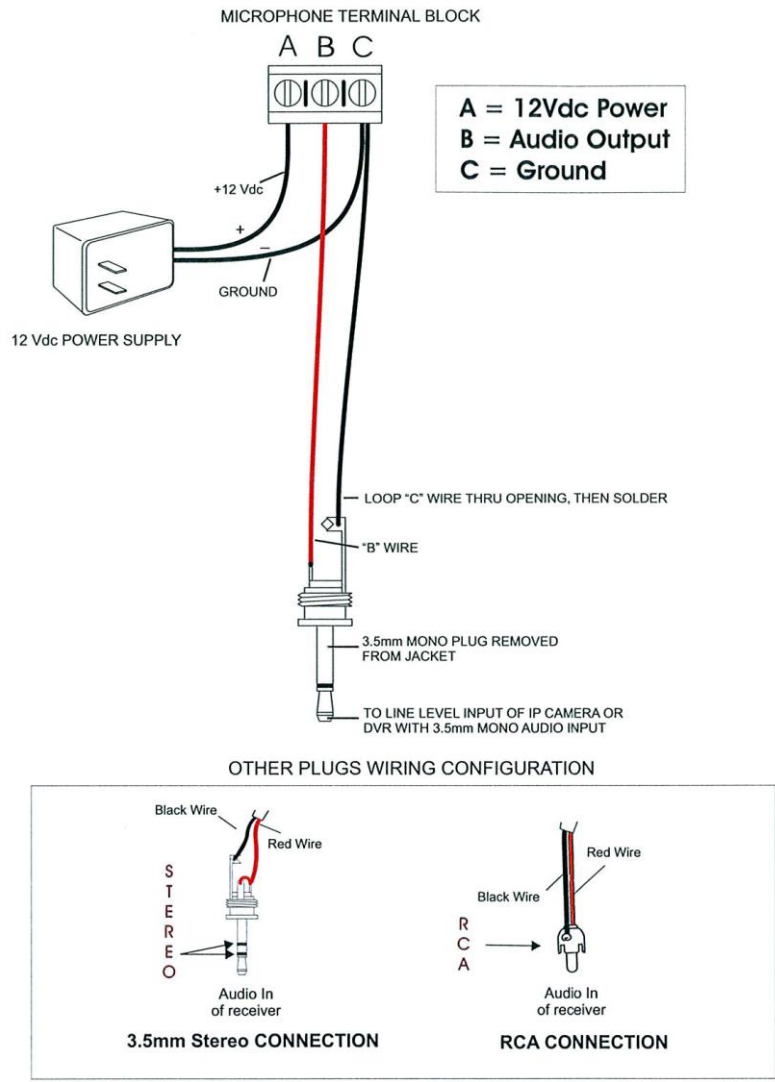

FIGURE 1

Figure 2 shows the diagram of wiring a LOUROE LE770 **MIC LEVEL MICROPHONE**
 (Please note, that the MIC LEVEL MICROPHONE does not require an external power supply)

Title:	Connecting a microphone to HikVision Cameras				
Date:	05/30/2014	Version:	1.0	Pages	7
Product:	IP cameras with audio input				
Action Required:	Information only				

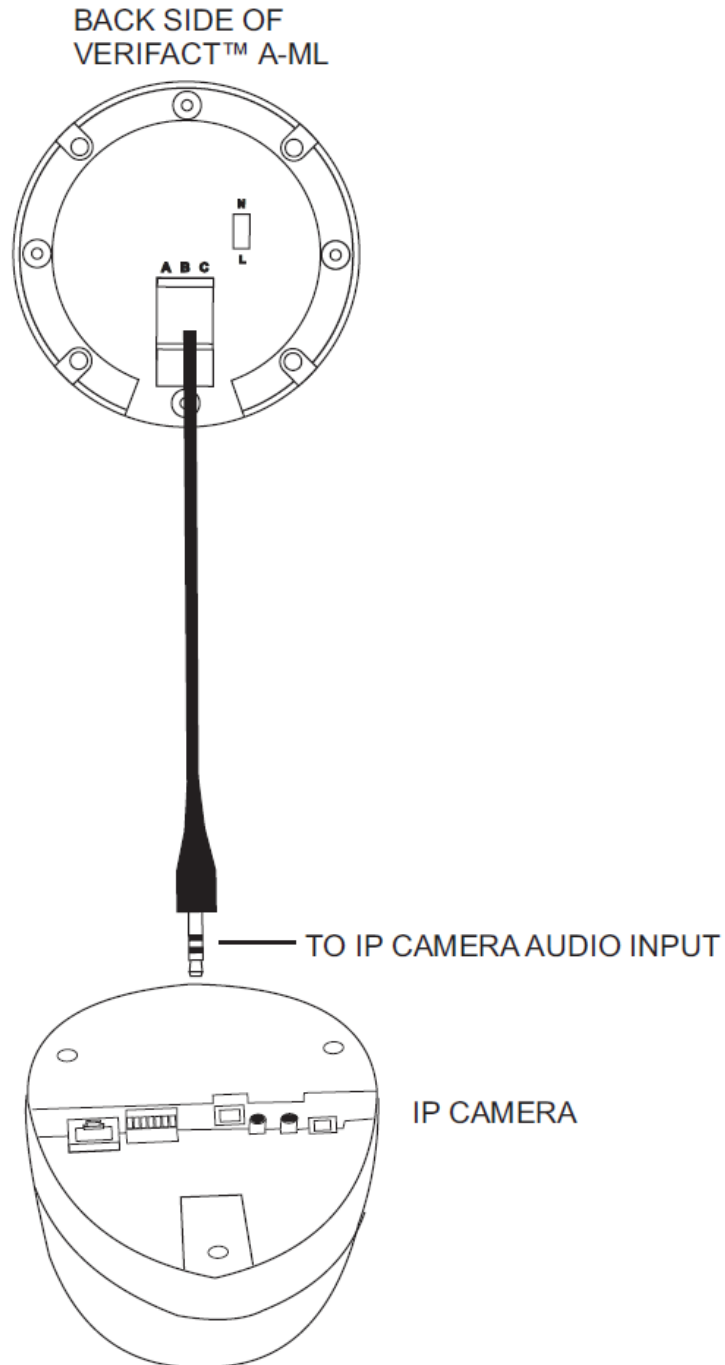

Figure 2

Title:	Connecting a microphone to HikVision Cameras				
Date:	05/30/2014	Version:	1.0	Pages	7
Product:	IP cameras with audio input				
Action Required:	Information only				

After the camera has been successfully connected to the camera, it is time to change the camera settings, so that the camera can treat the microphone for what it is.

Log in to the camera:

1. Go to “ADVANCED SETTINGS”
2. Click on “VIDEO/AUDIO”
3. Click on “AUDIO”
4. Change the Microphone type to “**LINE IN**” if using a **LINE LEVEL MICROPHONE**
5. Change the Microphone type to “**MIC IN**” if using a **MIC LEVEL MICROPHONE**

(FIGURE 3)

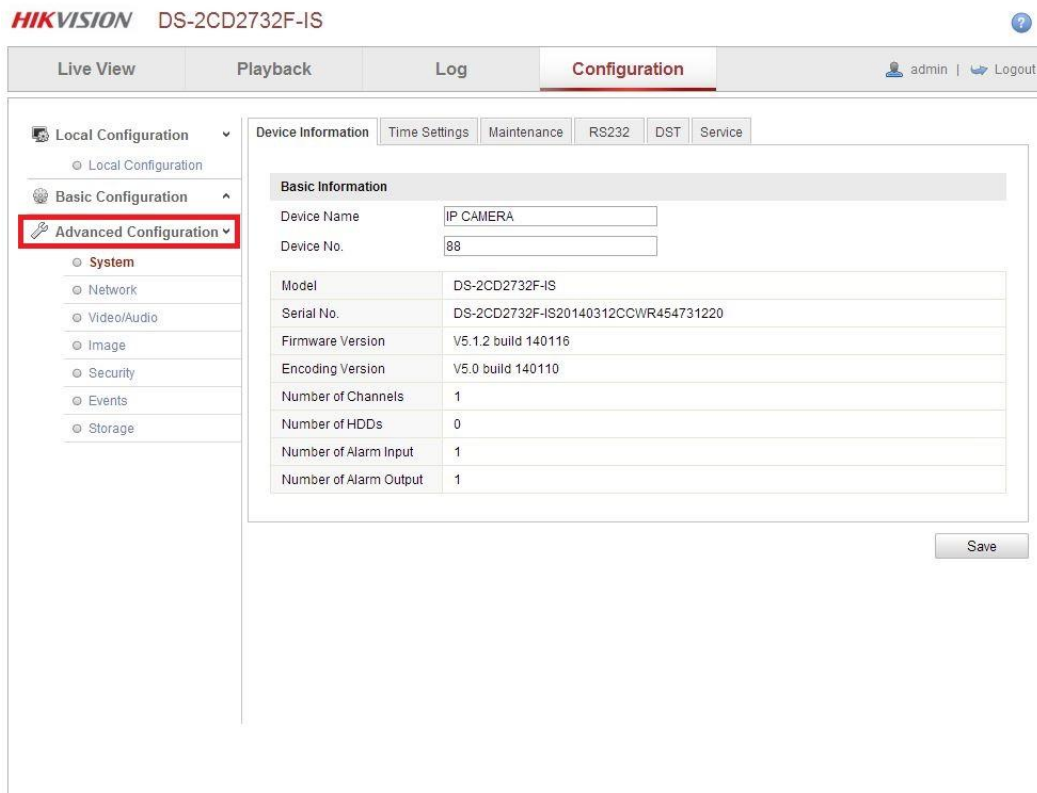

©Hikvision Digital Technology Co., Ltd. All Rights Reserved.

Figure 3 step 1

Title:	Connecting a microphone to HikVision Cameras				
Date:	05/30/2014	Version:	1.0	Pages	7
Product:	IP cameras with audio input				
Action Required:	Information only				

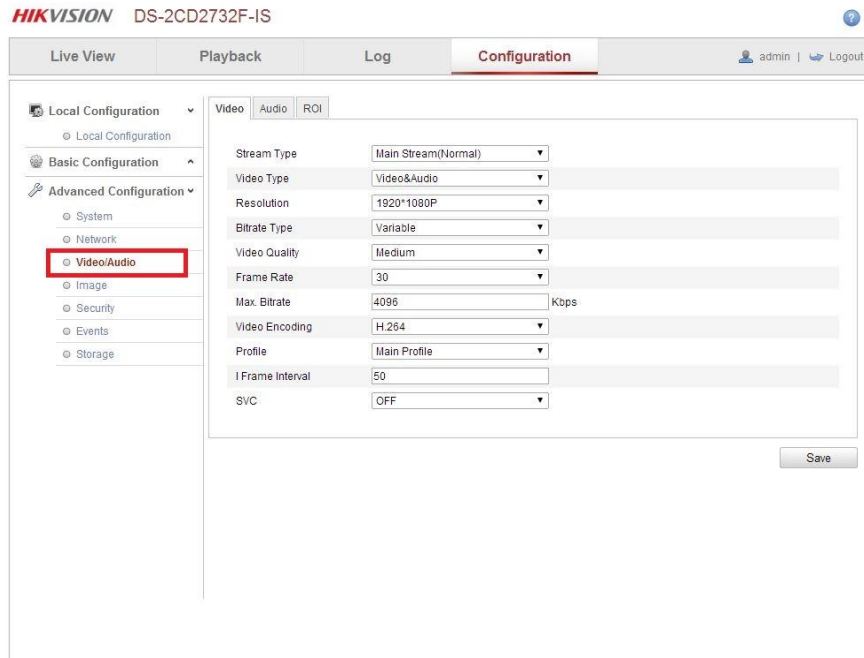

©Hikvision Digital Technology Co., Ltd. All Rights Reserved.

Figure 3 step 2

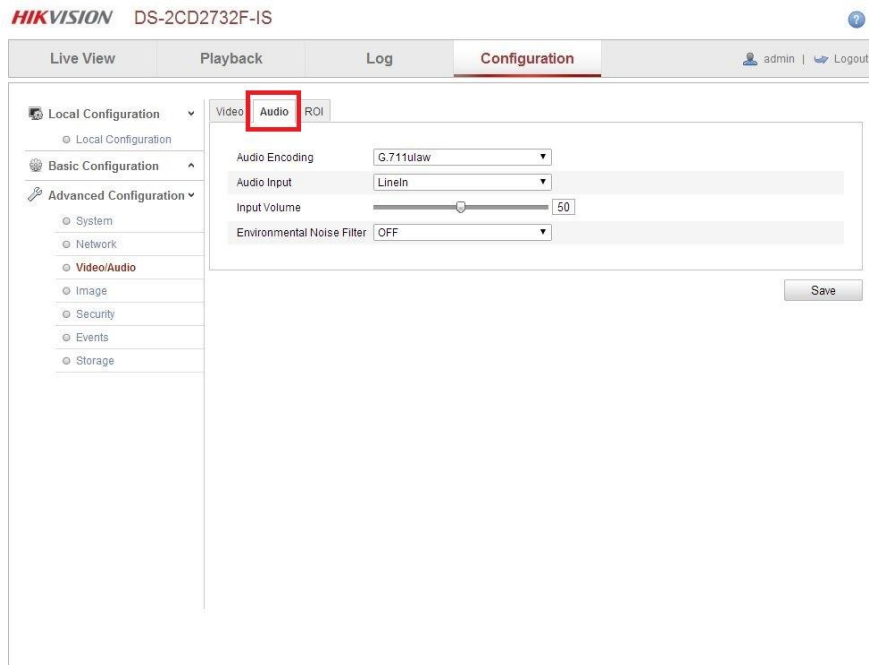

©Hikvision Digital Technology Co., Ltd. All Rights Reserved.

Figure 3 step 3

- 5 -

Hikvision USA, Inc.

908 Canada Court, Industry, CA 91748

Phone: 909-895-0400 Fax: 909-595-0788

Email: techsupport@hikvisionusa.com Website: <http://www.hikvision.com>

Title:	Connecting a microphone to HikVision Cameras				
Date:	05/30/2014	Version:	1.0	Pages	7
Product:	IP cameras with audio input				
Action Required:	Information only				

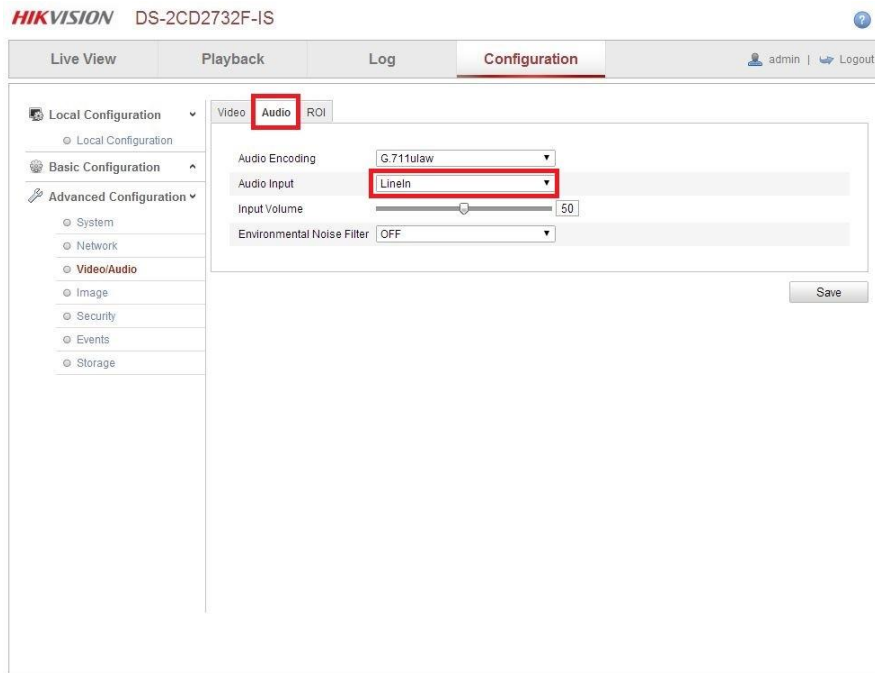

©Hikvision Digital Technology Co., Ltd. All Rights Reserved.

Figure 3 step 4

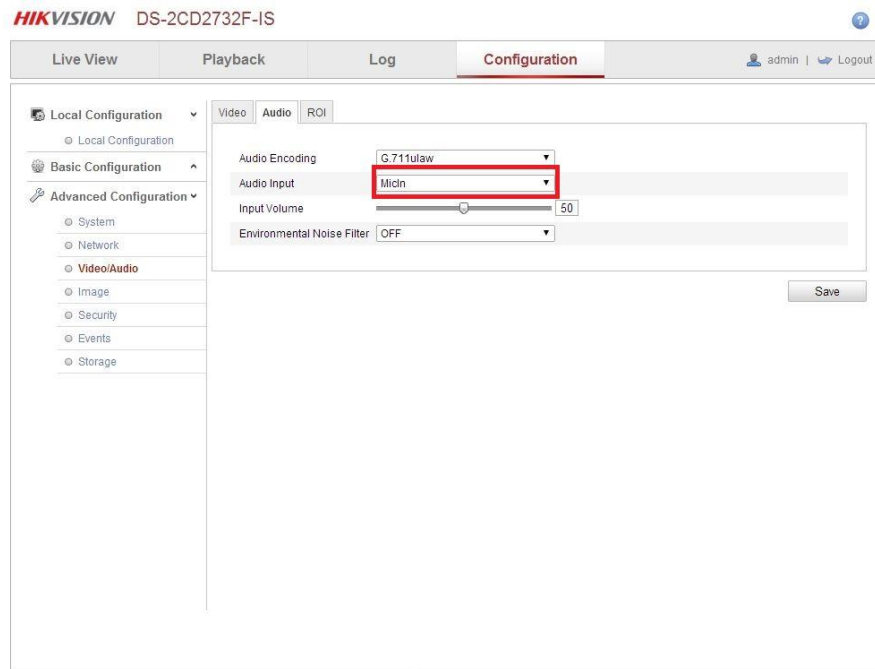

©Hikvision Digital Technology Co., Ltd. All Rights Reserved.

Figure 3 step 5

Title:	Connecting a microphone to HikVision Cameras				
Date:	05/30/2014	Version:	1.0	Pages	7
Product:	IP cameras with audio input				
Action Required:	Information only				

Passive Microphones are LINE LEVEL MICROPHONES.

When connecting a passive microphone to the camera, change the camera's Audio Input setting to "**LINE IN**".

Passive microphone wiring diagram is the same as **FIGURE 1**, with the only difference of having an **OPTIONAL POWER SUPPLY** (some passive microphones don't require power, some- do).

Please note that the diagrams above are for specific microphones only. These diagrams are not universal, and will not work for various microphones. Please consult the microphone manufacturer for wiring diagrams and power consumption ratings.